



Simply Better Connections

VM0202H / VM0202HB

4K HDMI Matrix Switch / 2 x 2 True
4K HDMI Matrix Switch with Audio
De-Embedder
User Manual

Compliance Statements

FEDERAL COMMUNICATIONS COMMISSION INTERFERENCE STATEMENT

This equipment has been tested and found to comply with the limits for a Class A digital device, pursuant to Part 15 of the FCC Rules. These limits are designed to provide reasonable protection against harmful interference when the equipment is operated in a commercial environment. This equipment generates, uses, and can radiate radio frequency energy and, if not installed and used in accordance with the instruction manual, may cause harmful interference to radio communications. Operation of this equipment in a residential area is likely to cause harmful interference in which case the user will be required to correct the interference at his own expense.

The device complies with Part 15 of the FCC Rules. Operation is subject to the following two conditions: (1) this device may not cause harmful interference, and (2) this device must accept any interference received, including interference that may cause undesired operation.

FCC Caution

Any changes or modifications not expressly approved by the party responsible for compliance could void the user's authority to operate this equipment.

Warning

Operation of this equipment in a residential environment could cause radio interference.

Achtung

Der Gebrauch dieses Geräts in Wohnumgebung kann Funkstörungen verursachen.



KCC Statement

유선 제품용 / A 급 기기 (업무용 방송 통신 기기)
이 기기는 업무용 (A 급) 전자파적합기기로서 판매자 또는 사용자는 이
점을 주의하시기 바라며, 가정 외의 지역에서 사용하는 것을 목적으로
합니다.

Industry Canada Statement

This Class A digital apparatus complies with Canadian ICES-003.

CAN ICES-003 (A) / NMB-003 (A)

HDMI Trademark Statement

The terms HDMI, HDMI High-Definition Multimedia Interface, and the HDMI Logo are trademarks or registered trademarks of HDMI Licensing Administrator, Inc.



RoHS

This product is RoHS compliant.

User Information

Online Registration

Be sure to register your product at our online support center:

International	http://eservice.aten.com
---------------	---

Telephone Support

For telephone support, call this number:

International	886-2-8692-6959
China	86-400-810-0-810
Japan	81-3-5615-5811
Korea	82-2-467-6789
North America	1-888-999-ATEN ext 4988 1-949-428-1111

User Notice

All information, documentation, and specifications contained in this manual are subject to change without prior notification by the manufacturer. The manufacturer makes no representations or warranties, either expressed or implied, with respect to the contents hereof and specifically disclaims any warranties as to merchantability or fitness for any particular purpose. Any of the manufacturer's software described in this manual is sold or licensed *as is*. Should the programs prove defective following their purchase, the buyer (and not the manufacturer, its distributor, or its dealer), assumes the entire cost of all necessary servicing, repair and any incidental or consequential damages resulting from any defect in the software.

The manufacturer of this system is not responsible for any radio and/or TV interference caused by unauthorized modifications to this device. It is the responsibility of the user to correct such interference.

The manufacturer is not responsible for any damage incurred in the operation of this system if the correct operational voltage setting was not selected prior to operation. PLEASE VERIFY THAT THE VOLTAGE SETTING IS CORRECT BEFORE USE.

Product Information

For information about all ATEN products and how they can help you connect without limits, visit ATEN on the Web or contact an ATEN Authorized Reseller. Visit ATEN on the Web for a list of locations and telephone numbers:

International	http://www.aten.com
North America	http://www.aten-usa.com

Package Contents

Check to make sure that all the components are in working order. If you encounter any problem, please contact your dealer.

VM0202H

- ◆ 1 VM0202H 4K HDMI Matrix Switch
- ◆ 1 IR remote control
- ◆ 1 IR receiver
- ◆ 1 power adapter
- ◆ 1 mounting kit
- ◆ 1 user instructions

VM0202HB

- ◆ 1 VM0202HB 2 x 2 True 4K HDMI Matrix Switch with Audio De-Embedder
- ◆ 1 IR remote control
- ◆ 1 IR receiver
- ◆ 1 power adapter
- ◆ 1 3-pole terminal block
- ◆ 1 mounting kit
- ◆ 1 user instructions

Contents

Compliance Statements	ii
User Information	iv
Online Registration	iv
Telephone Support	iv
User Notice	iv
Product Information	v
Package Contents	vi
Contents	vii
About this Manual	ix
Conventions	x
1. Introduction	
Overview	1
Features	2
Requirements	3
Source Device	3
Display Device	3
Cables	3
Components	4
VM0202H Front View	4
VM0202H Rear View	5
VM0202HB Front View	6
VM0202HB Rear View	7
IR Remote Control	8
2. Hardware Setup	
Rack Mounting	9
Grounding	11
Installation	12
VM0202H Installation	12
VM0202HB Installation	13
Installing the RS-232 Controller	15
3. Operation	
Overview	17
Front Panel Pushbuttons	17
Video Output Pushbuttons	17
Audio Output Pushbutton	18
Audio Channel Switch	18

IR Remote Control Operation	18
Switching the Input	19
Turning the Outputs on / off.	19
Turning All Outputs on/off	19

4. RS-232 Operation

Overview	21
Connecting to the Matrix Switch via RS-232	21
Command Verification	23
Commands	23
Switch Port Command	23
Audio Switch Command	25
Audio Mute Command	26
Auto Switch Command	27
Read Command	29
Echo Command	30
CEC Command	31
Panel Button Control Commands	32
EDID Mode Command	33
Reset Command	34

5. The Firmware Upgrade Utility

Introduction	35
Downloading the Firmware Upgrade Package	35
Preparation	36
Starting the Upgrade	37
Upgrade Failed	38
Firmware Upgrade Recovery	38

Appendix

Safety Instructions	39
General	39
Rack Mounting	41
Technical Support	42
International	42
North America	42
Specifications	43
ATEN Standard Warranty Policy	45
Limited Hardware Warranty	45

About this Manual

This User Manual is provided to help you get the most from your VM0202H / VM0202HB system. It covers all aspects of installation, configuration and operation. An overview of the information found in the manual is provided below.

Chapter 1, *Introduction*, introduces you to the VM0202H / VM0202HB system. Its purpose, features and benefits are presented, and its front and back panel components are described.

Chapter 2, *Hardware Setup*, describes how to set up your VM0202H / VM0202HB installation and all necessary steps are provided.

Chapter 3, *Operation*, explains the fundamental concepts involved in operating the VM0202H / VM0202HB via the front panel pushbuttons, and remote control.

Chapter 4, *RS-232 Operation*, provides a complete list of the serial control protocol commands used when utilizing the RS-232 Serial Port so that an extra source device can be utilized in the installation.

Chapter 5, *The Firmware Upgrade Utility*, explains how to download the VM0202H / VM0202HB's firmware and upgrade the device using the utility.

Appendix, provides specifications and other technical information regarding the VM0202H / VM0202HB.

Note:

- ◆ Read this manual thoroughly and follow the installation and operation procedures carefully to prevent any damage to the unit or any connected devices.
 - ◆ ATEN regularly updates its product documentation for new features and fixes. For an up-to-date VM0202H / VM0202HB documentation, visit <http://www.aten.com/global/en/>
-

Conventions

This manual uses the following conventions:

- Monospaced Indicates text that you should key in.
- [] Indicates keys you should press. For example, [Enter] means to press the **Enter** key. If keys need to be chorded, they appear together in the same bracket with a plus sign between them: [Ctrl+Alt].
1. Numbered lists represent procedures with sequential steps.
- ◆ Bullet lists provide information, but do not involve sequential steps.
- > Indicates selecting the option (on a menu or dialog box, for example), that comes next. For example, Start > Run means to open the *Start* menu, and then select *Run*.
-  Indicates critical information.

Chapter 1

Introduction

Overview

The VM0202H / VM0202HB is a 2 x 2 True 4K HDMI Matrix Switch featuring audio de-embedding (VM0202HB only). The VM0202H / VM0202HB offers an easy and affordable way to route True 4K high-definition HDMI video and audio. Supporting video resolutions up to 4096 x 2160@60Hz (4:4:4), HDR 10, HDR 10+, and HLG (VM0202HB only), audio de-embedder (VM0202HB only), and data rates up to 18 Gbps (VM0202HB only), the VM0202H / VM0202HB delivers robust signal routing and swift digital video/audio switching that is perfect for most AV applications.

The VM0202H / VM0202HB matrix switch delivers superior video resolutions up to 4096 x 2160@60Hz (4:4:4) (VM0202HB only), and also provides high-performance routing of 2 HDMI video sources such as high-definition Blu-ray players, home theater PCs, camcorders, DVD players, satellite boxes and stand-alone streaming media players to any 2 HDMI displays. In addition, the built-in audio de-embedder (VM0202HB only) allows HDMI audio extraction for independent analog audio output with ease. For efficient control and management, VM0202H / VM0202HB's remote control and front-panel pushbuttons provide a convenient way to cycle through HDMI video and audio sources with clear LED indication of the selected source.

Features

VM0202H

- ◆ Connects 2 HDMI sources to any of 2 HDMI displays
- ◆ Supports 4K resolutions of UHD (3840 x 2160) and DCI (4096 x 2160) with refresh rates of 30 Hz (4:4:4) and 60 Hz (4:2:0)
- ◆ EDID Expert™ – selects optimum EDID settings for smooth power-up, high-quality display, and use of the best video resolution across different screens
- ◆ Multiple Control Methods – system management via front-panel pushbuttons, IR and RS-232 serial control
- ◆ Supports Dolby True HD and DTS HD Master audio
- ◆ Signaling rates up to 3.4 Gbits for flawless 4K output
- ◆ HDMI (3D, Deep Color, 4K) and HDCP 1.4 compatible
- ◆ Consumer Electronics Control (CEC) allows interconnected HDMI devices to communicate and respond to a single remote control
- ◆ Supports ATEN LockPro™ HDMI cable lock for securing HDMI cables
- ◆ ESD protection for HDMI ports
- ◆ Firmware upgradeable
- ◆ Rack Mountable 1U design

VM0202HB

- ◆ Connects 2 HDMI sources to any of 2 HDMI displays
- ◆ Max. Data Rate 18.0 Gbps (6.0 Gbps Per Lane)
- ◆ Supports True 4K resolutions up to 4096 x 2160 @ 60Hz (4:4:4) and HDR include HDR 10, HDR 10+, and HLG
- ◆ Audio de-embedder – HDMI audio can be extracted to stereo or Line-out audio
- ◆ Multiple Control Methods—system management via front-panel pushbuttons, IR remote, and RS- 232 serial control
- ◆ Long-distance transmission up to 5 meters (with premium high-speed HDMI cable)
- ◆ HDMI (3D, 4k, Deep Color); HDCP 2.2 Compatible

- ◆ Consumer Electronics Control (CEC) allows interconnected HDMI devices to communicate and respond to one remote control
- ◆ EDID Expert™ — Selects optimum EDID settings for smooth power-up, high-quality display and use of the best video resolution across different screens
- ◆ Supports ATEN's Lock Pro™ HDMI cable lock for secure HDMI cable connections
- ◆ All metal casing
- ◆ Firmware upgradable
- ◆ Rack mountable (1U design)

Requirements

The following equipment is required for a complete VM0202H installation:

Source Device

- ◆ HDMI Type-A output connector(s)

Note: A DVI / HDMI adapter is required when connecting a DVI source device.

Display Device

- ◆ Display devices or receivers with an HDMI Type-A input connector

Cables

- ◆ 1 HDMI cable for each source device you will be connecting
- ◆ 1 HDMI cable for each display device you will be connecting
- ◆ 1 RS-232 serial cable

Note: 1. No cables are included in this package. We strongly recommend that you purchase high-quality cables of appropriate length since this will affect the quality of the audio and video display. Contact your dealer to purchase the correct cable sets.

2. If you wish to utilize the VM0202H / VM0202HB's high-end serial controller function, you will also need to purchase an appropriate RS-232 cable. See *VM0202HB Installation*, page 13.
-

Components

VM0202H Front View

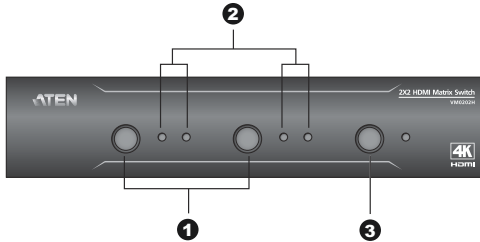

No.	Component	Description
1	video output pushbuttons	Press an output port pushbutton to select an input port. Note: The OUTPUT (1-2) front panel pushbuttons have built-in Green LEDs that light to indicate they have been selected.
2	input select LEDs	Indicates the input port of the corresponding output port (output 1 or 2).
3	power pushbutton	This pushbutton is to power on and off the VM0202H.

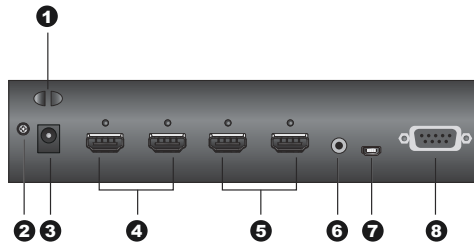
VM0202H Rear View

No.	Component	Description
1	cable tie slot	Receives a cable tie to hold the power cable in place.
2	grounding terminal	The grounding wire attaches here. Grounds the VM0202H to prevent damages from power surge or static electricity.
3	power jack	The power adapter cable from an AC source plugs in here. Receives a power adapter to supply power to the VM0202H.
4	HDMI output ports	The cables from your HDMI display devices plug into these ports.
5	HDMI input ports	The cables from your HDMI source devices plug into these ports.
6	external IR receiver port	Connect the IR receiver unit included with your product via this 3.5 mm mini stereo jack.
7	Micro USB Type-B port	Use this port to upgrade the firmware. See <i>The Firmware Upgrade Utility</i> , page 35.
8	RS-232 serial port	Connect a computer or high-end system controller via this serial port.

VM0202HB Front View

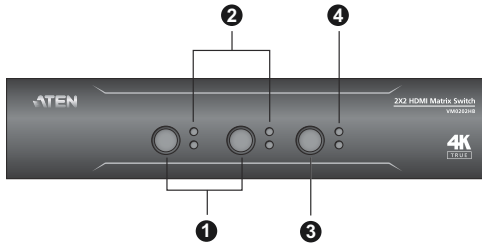

No.	Component	Description
1	video output pushbuttons	Press an output port pushbutton to select an input port. Note: The OUTPUT (1-2) front panel pushbuttons have built-in Green LEDs that light to indicate they have been selected.
2	video input LEDs	Indicates the input port of the corresponding output port (output 1 or 2).
3	audio output pushbutton	Press the audio output pushbutton to select an audio output source. Note: The OUTPUT (1-2) front panel pushbuttons have built-in Green LEDs that light to indicate they have been selected.
4	audio input LEDs	Indicates the audio input port of the corresponding input port (input 1 or 2).

VM0202HB Rear View

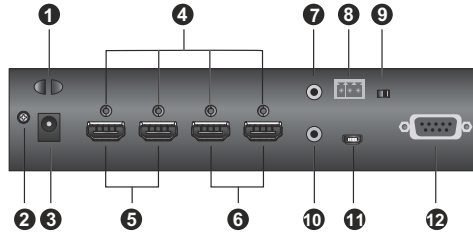

No.	Component	Description
1	cable tie slot	Receives a cable tie to hold the power cable in place.
2	grounding terminal	Grounds the VM0202HB to prevent damages from power surge or static electricity.
3	power jack	Receives a power adapter to supply power to the VM0202HB.
4	cable lock screw for ATEN LockPro™	A universal HDMI cable lock that provides the easiest way to secure an HDMI cable to most HDMI devices.
5	HDMI output ports	The cables from your HDMI display devices plug into these ports.
6	HDMI input ports	The cables from your HDMI source devices plug into these ports.
7	stereo audio out port	Connect an audio output device into this port.
8	stereo line out port	Connect the cables from your audio output device into these ports.
9	audio channel switch	Use the switch to set an audio channel from 2 channel or bypass.
10	IR receiver port	Connect the IR Receiver unit included with your product via this 3.5 mm mini stereo jack.
11	firmware upgrade port	Use this port to upgrade the firmware. See <i>The Firmware Upgrade Utility</i> , page 35.
12	RS-232 serial port	Connect a computer or high-end system controller via this serial port.

IR Remote Control

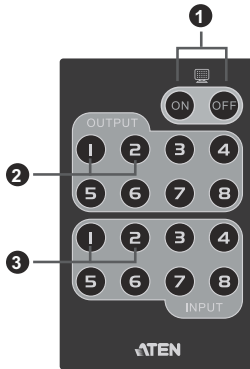

No.	Component	Description
1	power On / Off	Use the On and Off pushbuttons to turn the output displays on or off – by individual port, or all ports. See <i>IR Remote Control Operation</i> , page 18. Note: This pushbutton only works on VM0202H.
2	video output pushbuttons 1-2	Press the video output pushbuttons 1-2 to select the display you want to configure, then within 2 seconds press the input pushbutton 1-2 to select the source for the display. For detailed instructions, see <i>IR Remote Control Operation</i> , page 18.
3	video input pushbuttons 1-2	Press the input pushbuttons 1-2 to select the source you want to display after you have pressed an output pushbutton 1-2. You must press the input pushbutton within 2 seconds after pressing the output pushbutton, For detailed instructions, see <i>IR Remote Control Operation</i> , page 18.

Chapter 2

Hardware Setup



1. Important safety information regarding the placement of this device is provided on page 39. Please review it before proceeding.
2. Make sure that the power to all devices connected to the installation are turned off.
3. Make sure that all devices you will be installing are properly grounded.

Rack Mounting

For convenience and flexibility, the VM0202H / VM0202HB can be mounted on system racks. To rack mount a unit do the following:

Note: The unit used in the diagram below is VM0202H, the procedure for connecting the VM0202HB is identical to the VM0202H.

1. Using the screws provided in the mounting kit, screw the mounting bracket to the side of the unit as show in the diagram below:

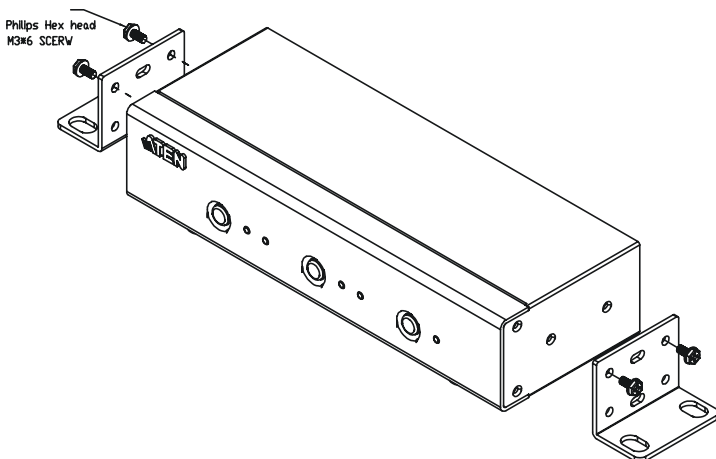

2. Screw the bracket into a convenient location on the rack.

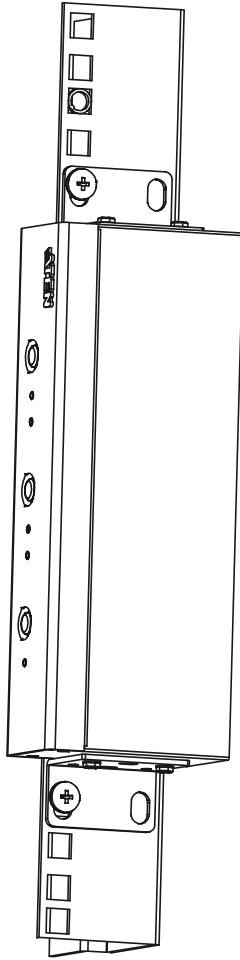

Grounding

To prevent damage to your installation it is important that all devices are properly grounded.

1. Use a grounding wire to ground the VM0202H / VM0202HB by connecting one end of the wire to the grounding terminal, and the other end of the wire to a suitable grounded object.

VM0202H



VM0202HB

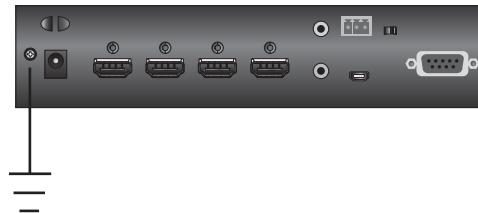

2. Make sure that the devices that the VM0202H / VM0202HB connects to are properly grounded.

Installation

Installation of the VM0202H is simply a matter of plugging in the appropriate cables.

VM0202H Installation

To install the switch, refer to the installation diagram below as you perform the following steps:

1. (Optional) If you are using the serial control function, use an appropriate RS-232 serial cable to connect the computer or serial controller to the VM0202H's female RS-232 serial port.
2. Use a grounding wire to ground the unit by connecting one end of the wire to the grounding terminal and the other end of the wire to a suitably grounded object.

Note: Do not omit the step. Proper grounding helps to prevent damage to the unit from power surges or static electricity.

3. Use HDMI cables to connect the video display devices to the HDMI output ports on the back of the VM0202H.
4. Use HDMI cables to connect the video source devices to the HDMI input ports on the back of the VM0202H.
5. Connect the IR receiver to the IR receiver port.
6. Plug the provided power adapter into an appropriate AC power source; plug the power adapter cable into the power jack on the back of the VM0202H.
7. Power on the VM0202H, the display, and source devices.

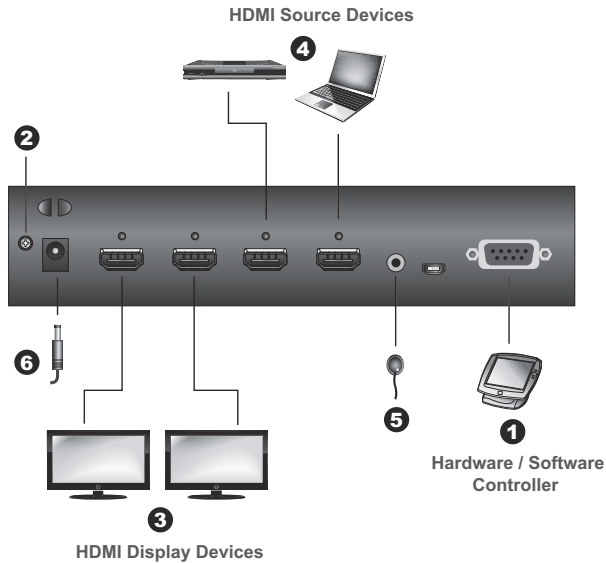

VM0202HB Installation

To install the switch, refer to the installation diagram below as you perform the following steps:

1. Use a grounding wire to ground the unit by connecting one end to the grounding terminal, and the other end to a suitable grounded object.

Note: Do not omit the step. Proper grounding helps to prevent damage to the unit from power surges or static electricity.

2. Connect the unit to up to two HDMI sources using HDMI cables. Optionally secure the cables with ATEN LockPro™.

Note: Please set the EDID Mode to port 1 EDID when you are connecting an HDMI source with resolution 1080p @ 30Hz, see *EDID Mode Command*, page 33.

3. Connect the unit to up to two HDMI-enabled displays using HDMI cables. Optionally secure the cables with ATEN LockPro™.

Note: Please set the EDID Mode to port 1 EDID when you are connecting an HDMI-enabled display with resolution 1080p @ 30Hz, see *EDID Mode Command*, page 33.

4. (Optional) To extract HDMI audio, connect a speaker to the stereo audio out or stereo line out port.
5. (Optional) To choose between HDMI audio bypass or 2-channel audio for the connected speakers, switch the audio channel switch to **BYPASS** or **CH2**.
6. (Optional) To switch sources using IR remote control, connect the supplied IR receiver to the IR receiver port.
7. (Optional) To perform system control using a serial device via RS-232, follow the steps below.
 - a) Connect the serial controller to the RS-232 serial port on the VM0202HB using a 9-wire straight cable, with only pin 2 to pin 2, pin 3 to pin 3, and pin 5 to pin 5 connected.
 - b) Configure the serial controller's control port to the following:

RS-232 Protocol	
Baud Rate	19200
Data Bits	8
Parity	None
Stop Bits	1
Flow Control	None

8. Plug the power adapter to an appropriate AC power source, and the adapter cable into the power jack on the VM0202HB.
9. Power on all the connected devices.

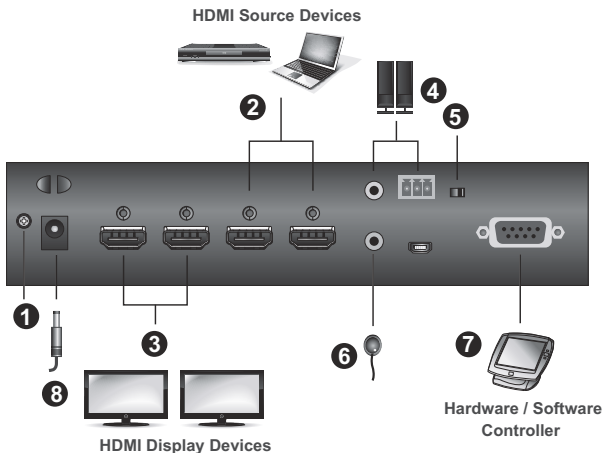

Installing the RS-232 Controller

In order to use the RS-232 serial interface to attach a high-end controller (such as a PC) to the VM0202H / VM0202HB, use a serial cable such as a modem cable. The end connecting to the VM0202H / VM0202HB should have a 9-pin male connector. Connect this to the serial interface on the rear of the VM0202H / VM0202HB.

For VM0202H installation, refer to step 1 from the installation diagram on page 13.

For VM0202HB installation, refer to step 7 from the installation diagram on page 14.

Note: To configure the controller serial port, see page 21.

This Page Intentionally Left Blank

Chapter 3 Operation

Overview

This chapter provides detailed information on operating the VM0202H / VM0202HB using the panel pushbuttons and IR remote controller.

Front Panel Pushbuttons

Video Output Pushbuttons

To manually select an HDMI source for an HDMI display, use the video output pushbuttons located on the VM0202H / VM0202HB's front panel to select the output and input connections.

Press the video output pushbutton that corresponds to the port, which the display is connected to. Pressing the pushbutton will cycle between the two attached HDMI source devices (source 1 and 2) through the display devices.

VM0202H



video output pushbuttons

VM0202HB



video output pushbuttons

Audio Output Pushbutton

To manually select and extract an audio output source from the connected HDMI source devices, or to mute the audio output, use the audio output pushbutton located on the VM0202HB's front panel to select an audio output or mute the audio output.

Note: This audio output pushbutton is only available on VM0202HB.



audio output pushbutton

Pressing the audio output pushbutton will cycle between the two attached HDMI source devices (source 1 and 2).

Audio Channel Switch

The audio channel switch allows you to bypass or set audio CH 2 for the connected speakers.



audio channel switch

IR Remote Control Operation

The IR remote control (*IR Remote Control*, page 8) included with the VM0202H / VM0202HB can be used to:

- ◆ Change the input source of any output display
- ◆ Turning on/off individual output display
- ◆ Turning on/off all output displays simultaneously

Before using the remote control, a user must first plug the IR receiver into the rear panel of the VM0202H / VM0202HB and place the receiver where the IR signal can be reached (see *IR Remote Control*, page 8).

Switching the Input

To change the input source of an output display using the remote control, do the following:

1. Press the **output** port button (1-2) that you want to change.
2. Within 2 seconds press the **input** port button (1-2) you want the output port to display.

Note: For the change to occur the input number must be pressed within 2 seconds of pressing the output number.

3. Repeat steps 1-2 to change additional ports.

Turning the Outputs on / off

To turn an output on / off using the remote control, do the following:

1. Press the **output** port button (1-2) that you want to turn off.
2. Within 2 seconds press the **ON** or **OFF** button on the remote control.

Note: If the **ON** or **OFF** button is pressed *after* 2 seconds of pressing the output port number, all the displays are powered on or off instead of just the intended output port.

3. Repeat steps 1-2 to turn the output back on / off.

Turning All Outputs on/off

To have all output displays turned on or off, regardless of the current power statuses, press the **ON** or **OFF** button on the remote control.

This Page Intentionally Left Blank

Chapter 4

RS-232 Operation

Overview

The VM0202H / VM0202HB's can be configured and controlled via RS-232 commands when connected to a host computer or other device, such as a control system. This chapter provides information on how to connect to the VM0202H / VM0202HB via RS-232/Telnet and command syntax.

Connecting to the Matrix Switch via RS-232

You can control and operate the VM0202H / VM0202HB using a high-end controller or PC. To connect to the VM0202H / VM0202HB via RS-232, do the following:

1. Connect the RS-232 serial port on the VM0202H / VM0202HB to the RS-232 serial port on your computer using a 9-wire straight cable, with only pin 2 to pin 2, pin 3 to pin 3, and pin 5 to pin 5 connected.

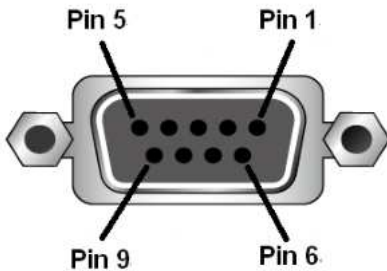

Pin	Description
1	Not connected
2	RXD
3	TXD
4	Not connected
5	GND
6	Not connected
7	Not connected
8	Not connected
9	Not connected

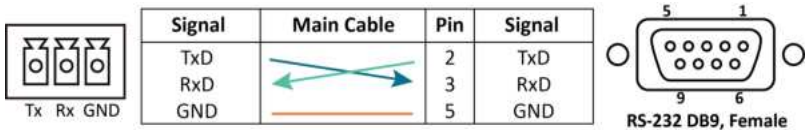

2. The controller's serial port should be configured as follows:

RS-232 Protocol	
Baud Rate	19200
Data Bits	8
Parity	None
Stop Bits	1
Flow Control	None

3. When a session is established with the VM0202H / VM0202HB, you can control and configure the VM0202H / VM0202HB via RS-232 commands. For more information on commands, see *Commands*, page 23.

Command Verification

After entering a command, a verification message appears at the end of the command line as follows:

- ◆ **Command OK** - indicates that the command is correct and successfully performed by the switch
- ◆ **Command incorrect** - indicates that the command has the wrong format and/or values.

Commands

After connecting to the VM0202H / VM0202HB via Telnet or RS-232, you can operate the system using the following commands.

Switch Port Command

The Switch Port command allows you to switch ports on the VM0202H / VM0202HB.

The formula for the Switch command is as follows:

Command + Input + Number + Output + Number + Control + [Enter]

1. For example, to switch input port 02 (audio and video) to output port 01, type:

sw i02 o01 [Enter]

2. To turn off video and audio output on port 02, type:

sw o02 off [Enter]

3. To switch the next output to port 02, type:

sw i02 + [Enter]

The following tables show the possible values for the **Switch Port** command:

Command	Description
sw	Switch command

Input Command	Description
i	Input command

Port number	Description
xx	01-02 port (default is 01)

Output Command	Description
o	Output command

Port number	Description
yy	01-02 port (default is 01)
*	All output ports

Control	Description
on	Turn on the display
off	Turn off the display
+	Next Port
-	Previous Port

- Note:**
1. By default, input port 01 is tied to output port 01; input port 02 is tied to output port 02 (i.e., o01 i01, o02 i02).
 2. Each command string can be separated with a space.
 3. The **Port Number** can be skipped, and the default value will be used.
 4. For this Switch Port Command to work, remember to enable the Panel Button Control function, see *Panel Button Control Commands*, page 32.

The following table lists the available Switch Port commands:

Command	Input Command	Input Port	Output Command	Output Port	Control	Enter	Description
sw	i	xx	o	yy *		[Enter]	Switch Input Port xx to Output Port yy (xx:01~02; yy:01~02, *)
sw			o	yy *	on off	[Enter]	Turn on Output Port yy Turn off Output Port yy (yy:01~02, *)
sw			o	yy *	+ -	[Enter]	Switch Output port yy to next Output port. Switch Output port yy to previous Output port. (yy:01~02, *)

Audio Switch Command

The Audio Switch command allows you to extract audio from the connected HDMI inputs and output the extracted audio via the speaker connected to the Stereo Audio Out or Stereo Line Out Port.

Note: This Audio Switch command is only available on VM0202HB.

The formula for the Read command is as follows:

Command + Input + Number + Output + Number + Control + [Enter]

- To extract audio from HDMI input port 1, type:
sw i01 o01 diso [Enter]
- To end the stereo audio output, type:
sw audio off [Enter]

The following tables show the possible values for the **Audio Switch** command:

Command	Description
sw	Switch command

Input Command	Description
i	Input command

Port number	Description
xx	01-02 port (default is 01)

Output Command	Description
o	Output command

Port number	Description
yy	01

Control	Description
diso	Extract audio is enabled
audio off	Extract audio is disabled

Note: Each command string can be separated with a space.

The following tables lists the available Audio Switch commands:

Command	Input Command	Input Port	Output Command	Output Port	Control	Enter	Description
sw	i	xx	o	yy	diso	[Enter]	Extract and output the audio signal from the Input Port xx to the connected speakers. (xx:01~02; yy:01)
sw	N/A	N/A	N/A	N/A	audio off	[Enter]	Disable audio extract.

Audio Mute Command

The Audio Mute command allows you to mute or unmute the connected HDMI output ports. The default setting is off.

The formula for the Read command is as follows:

Command + Output + Number + Control + [Enter]

- To mute the HDMI output port 1, type:
mute o01 on [Enter]
- To unmute all the HDMI output ports, type:
mute o* off [Enter] or **mute off [Enter]**

The following tables show the possible values for the **Audio Mute** command:

Command	Description
mute	Mute command

Output Command	Description
o	Output command

Port number	Description
yy	01-02 port (default is 01)
*	All output ports

Control	Description
on	Mute on; audio output is disabled
off	Mute off; audio output is enabled (default)

Note: 1. Each command string can be separated with a space.

2. Skip the output port command to mute or enable the audio of all output ports.

The following tables lists the available Audio Switch commands:

Command	Output Command	Output Port	Control	Enter	Description
mute	o	yy *	on	[Enter]	Audio off for output port yy (yy:01~02, *)
mute			on	[Enter]	Audio off for all output ports
mute	o	yy *	off	[Enter]	Audio on for output port yy (default) (yy:01~02, *)
mute			off	[Enter]	Audio on for all output ports

Auto Switch Command

The Auto Switch command allows you to set different auto switch mode for the connected HDMI outputs.

Note: Auto switch commands only support on VM0202HB.

The formula for the Auto Switch command is as follows:

Command + Output + Number + Mode + Control + [Enter]

1. To set the switch mode to auto switch mode, type:
swmode plugin auto [Enter]
2. To set HDMI output port 2 to the previous available port when the current port is unplugged, type:
swmode o02 plugout prev [Enter]

The following tables show the possible values for the **Auto Switch** command:

Command	Description
swmode	Auto switch command

Output Command	Description
o	Output command

Port number	Description
yy	01-02 port (default is 01)
*	All output ports

Mode	Description
Plugin	When the HDMI input(s) is/are plugged in
Plugout	When the HDMI input(s) is/are unplugged

Control	Description
auto	Auto switch to the latest detected input source
next	Auto switch to the next available input source
prev	Auto switch to the previous available input source
off	Disable auto switch mode

-
- Note:** 1. Each command string can be separated with a space.
2. Skip the output port command to automatically switch the audio of all output ports.
-

The following tables lists the available Audio Switch commands:

Command	Output Command	Output Port	Mode	Control	Enter	Description
swmode	o	yy *	plugin	auto	[Enter]	Switch output port xx to automatically switch to the latest detected input source when the HDMI input(s) is/are plugged in (yy:01~02, *).
swmode	o	yy *	plugin	off	[Enter]	Disable auto switch when the HDMI input(s) is/are plugged in.
swmode	o	yy *	plugout	next	[Enter]	Switch output port xx to automatically switch to the next available input source when the HDMI input(s) is/are unplugged (yy:01~02, *).
swmode	o	yy *	plugout	prev	[Enter]	Switch output port xx to automatically switch to the previous available input source when the HDMI input(s) is/are unplugged (yy:01~02, *).
swmode	o	yy *	plugout	off	[Enter]	Disable auto switch when the HDMI input(s) is/are unplugged.

Read Command

The Read command allows you to view the current configuration, firmware and other information about the device.

The formula for the Read command is as follows:

Command + [Enter]

To view information about the device, type:

read [Enter]

The following tables show the possible values for the **Read** command:

Command	Description
read	Read command

The following tables lists the available Read commands:

Command	Enter	Description
read	[Enter]	View information about the device

Echo Command

The Echo function updates the RS-232 controller when operations are made via the front panel pushbuttons or IR remote control. The changes echo back to the RS-232 controller to keep the settings in sync with the device.

The formula for the Echo command is as follows:

Command + Control + [Enter]

For example, to enable the echo feature, type:

echo on [Enter]

The following tables show the possible values for the **Echo** command:

Command	Description
echo	Echo command

Control	Description
on	Turns Echo function on
off	Turns Echo function off (default)

Note: Each command string can be separated with a space.

The following tables lists the available Echo commands:

Command	Control	Enter	Description
echo	on	[Enter]	Turn on Echo function
echo	off	[Enter]	Turn off Echo function

CEC Command

Consumer Electronics Control (CEC) allows interconnected HDMI devices to communicate with and respond to the same remote control.

The formula for the CEC command is as follows:

Command + Output + Number + Control + [Enter]

For example, to enable the CEC function on output port 1, type:

cec o01 on [enter]

The following tables show the possible values for the CEC command:

Command	Description
cec	CEC command

Output Command	Description
o	Output command

Port number	Description
yy	01~02 (default is 01)
*	All output ports

Control	Description
off	Disable CEC (default)
on	Enable CEC

Note: Each command string can be separated with a space.

The following tables lists the available CEC commands:

Command	Output Command	Output Port	Control	Enter	Description
cec	o	yy *	off	[Enter]	CEC off for output port yy (default) (yy:01~02, *)
cec	o	yy *	on	[Enter]	CEC on for output port yy (yy:01~02, *)

Panel Button Control Commands

The Panel Button Control command allows you to enable or disable the Panel Button Control for the VM0202H / VM0202HB.

The formula for the Panel Button Control command is as follows:

Command + Control + [Enter]

For example, to enable the front panel pushbutton control, type:

button on [enter]

The following tables show the possible values for the **Panel Button Control** command:

Command	Description
button	Panel Button Control command

Control	Description
on	Enable front panel pushbutton control (default)
off	Disable front panel pushbutton control

Note: Each command string can be separated with a space.

The following tables lists the LED behavior under Panel Button Control commands:

Behavior	Front Panel Pushbuttons Disabled	Front Panel Pushbuttons Enabled
When push any button	LEDs flash twice, then LEDs light on	LEDs light on and no flash

EDID Mode Command

Extended Display Identification Data (EDID) is a data that contains a display's basic information and is used to communicate with the video source.

The formula for the EDID command is as follows:

Command + Control + [Enter]

For example, to use the Port1 EDID mode, type:

edid port1 [enter]

The following tables show the possible values for the **EDID** command:

Command	Description
edid	EDID Mode command

Control	Description
port1	Implement the EDID of the connected display to Output 1, and pass it to the video source.
remix	Implement the EDID of each connected display according to its connection when the VM0202H / VM0202HB is first powered on, or immediately after selecting the Remix option.
default	Implements ATEN's default EDID. (default)

Note: Each command string can be separated with a space.

The following tables lists the available EDID commands:

Command	Control	Enter	Description
edid	port1	[Enter]	The EDID from Output 1 is passed to the video source.
edid	remix	[Enter]	The VM0202H / VM0202HB implements the EDID of each connected display according to its connection when the VM0202H / VM0202HB is first powered on, or immediately after selecting the Remix option.
edid	default	[Enter]	ATEN's default EDID is passed to the video source.

Reset Command

The Reset command allows you to reset the VM0202H / VM0202HB to the default factory settings.

The formula for the Reset command is as follows:

Command + [Enter]

The following tables show the possible values for the **Reset** command:

Command	Description
reset	Reset command

The following tables lists the available Reset commands:

Command	Enter	Description
reset	[Enter]	Resets the device settings

Chapter 5

The Firmware Upgrade Utility

Introduction

The purpose of the Windows-based Firmware Upgrade Utility is to provide an easy process for upgrading the VM0202H / VM0202HB. The program comes as part of a Firmware Upgrade Package that is specific for each device.

As new firmware versions become available, new firmware upgrade packages are posted on our website. Check the website regularly to find the latest information and packages.

Downloading the Firmware Upgrade Package

To download the firmware upgrade package:

1. On our Website go to: *Download - Firmware* and choose the device model, or from the VM0202H / VM0202HB product page under the *Resources* tab, select *Firmware*. A list of available firmware upgrade packages appears.
2. Choose the firmware upgrade package that you wish to install (usually the most recent) and download it to your computer.

Preparation

To prepare for the firmware upgrade, do the following:

1. Use a Micro USB Type-B cable to connect a USB port on your computer to the firmware upgrade port of your VM0202H / VM0202HB.

VM0202H

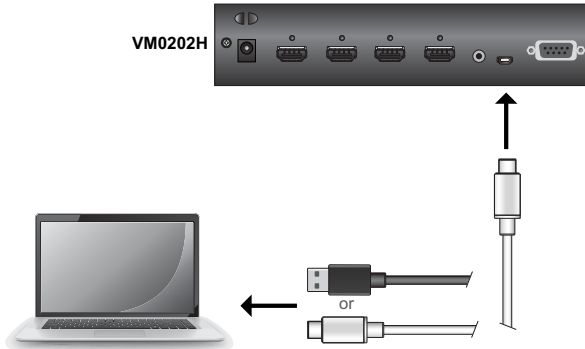

VM0202HB

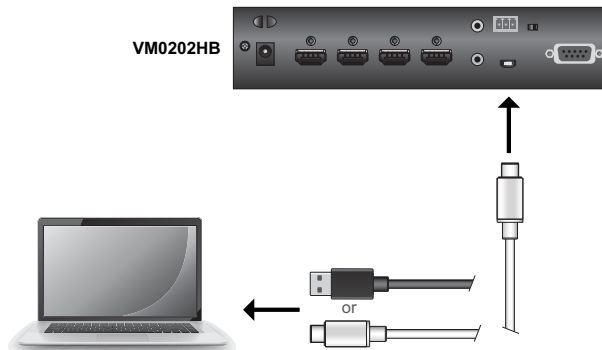

2. Unplug the VM0202H / VM0202HB's power adapter.
3. Power on the VM0202H / VM0202HB.
 - a) To power on the VM0202H, plug the power adapter to the power jack located on the rear panel, and press the power pushbutton located on the front panel.
4. To power on the VM0202HB, plug the power adapter to the power jack located on the rear panel.
5. You can start the upgrade process as explained on the next page.

Starting the Upgrade

To upgrade the firmware:

1. Run the downloaded firmware upgrade package file either by double-clicking the file icon.

The *Firmware Upgrade Utility* welcome screen appears:

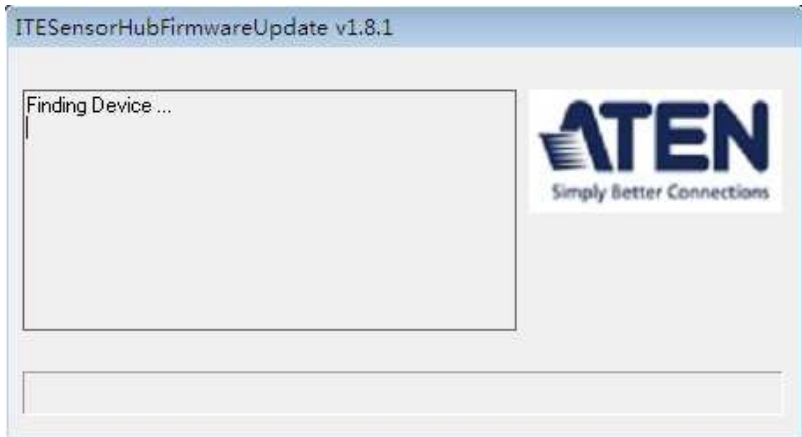

2. After the upgrade is complete, a successful message appear:

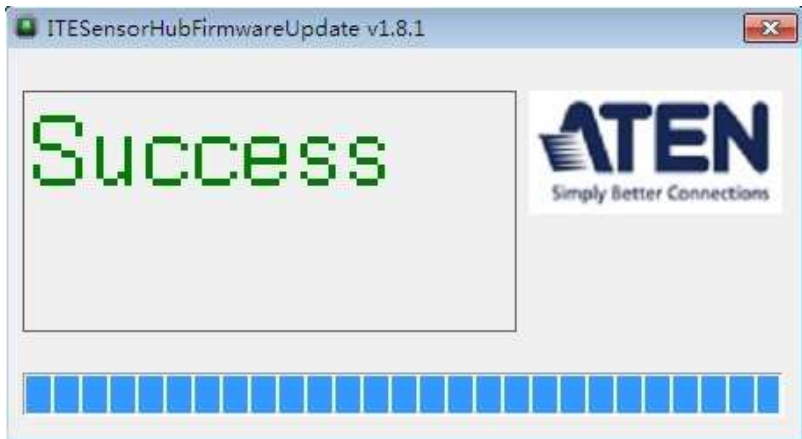

3. Now you can power off the VM0202H / VM0202HB, then power it back on again.

Upgrade Failed

If the *Upgrade Succeeded* screen doesn't appear, it means that the upgrade failed to complete successfully. See the next section, *Firmware Upgrade Recovery*, for how to proceed.

Firmware Upgrade Recovery

There are three conditions that call for firmware upgrade recovery:

- ◆ When a firmware upgrade is manually aborted.
- ◆ When the mainboard firmware upgrade fails.
- ◆ When the I/O firmware upgrade fails.

To perform a firmware upgrade recovery, do the following:

1. Power off the device.
2. Connect the Micro USB Type-B cable to the *firmware upgrade port*.
3. Repeat the upgrade procedure.

Safety Instructions

General

- ◆ Read all of these instructions. Save them for future reference.
- ◆ Follow all warnings and instructions marked on the device.
- ◆ This product is for indoor use only.
- ◆ Do not place the device on any unstable surface (cart, stand, table, etc.). If the device falls, serious damage will result.
- ◆ Do not use the device near water.
- ◆ Do not place the device near, or over, radiators or heat registers.
- ◆ The device cabinet is provided with slots and openings to allow for adequate ventilation. To ensure reliable operation, and to protect against overheating, these openings must never be blocked or covered.
- ◆ The device should never be placed on a soft surface (bed, sofa, rug, etc.) as this will block its ventilation openings. Likewise, the device should not be placed in a built in enclosure unless adequate ventilation has been provided.
- ◆ Never spill liquid of any kind on the device.
- ◆ Unplug the device from the wall outlet before cleaning. Do not use liquid or aerosol cleaners. Use a damp cloth for cleaning.
- ◆ The device should be operated from the type of power source indicated on the marking label. If you are not sure of the type of power available, consult your dealer or local power company.
- ◆ To prevent damage to your installation it is important that all devices are properly grounded.
- ◆ The device is equipped with a DC adapter. This is a safety feature.
- ◆ Position system cables and power cables carefully; Be sure that nothing rests on any cables.
- ◆ Never push objects of any kind into or through cabinet slots. They may touch dangerous voltage points or short out parts resulting in a risk of fire or electrical shock.
- ◆ Do not attempt to service the device yourself. Refer all servicing to qualified service personnel.

- ◆ If the following conditions occur, unplug the device from the wall outlet and bring it to qualified service personnel for repair.
 - ◆ Liquid has been spilled into the device.
 - ◆ The device has been exposed to rain or water.
 - ◆ The device has been dropped, or the cabinet has been damaged.
 - ◆ The device exhibits a distinct change in performance, indicating a need for service.
 - ◆ The device does not operate normally when the operating instructions are followed.
- ◆ Only adjust those controls that are covered in the operating instructions. Improper adjustment of other controls may result in damage that will require extensive work by a qualified technician to repair.

Rack Mounting

- ◆ Before working on the rack, make sure that the stabilizers are secured to the rack, extended to the floor, and that the full weight of the rack rests on the floor. Install front and side stabilizers on a single rack or front stabilizers for joined multiple racks before working on the rack.
- ◆ Always load the rack from the bottom up, and load the heaviest item in the rack first.
- ◆ Make sure that the rack is level and stable before extending a device from the rack.
- ◆ Use caution when pressing the device rail release latches and sliding a device into or out of a rack; the slide rails can pinch your fingers.
- ◆ After a device is inserted into the rack, carefully extend the rail into a locking position, and then slide the device into the rack.
- ◆ Do not overload the AC supply branch circuit that provides power to the rack. The total rack load should not exceed 80 percent of the branch circuit rating.
- ◆ Make sure that all equipment used on the rack – including power strips and other electrical connectors – is properly grounded.
- ◆ Ensure that proper airflow is provided to devices in the rack.
- ◆ Ensure that the operating ambient temperature of the rack environment does not exceed the maximum ambient temperature specified for the equipment by the manufacturer.
- ◆ Do not step on or stand on any device when servicing other devices in a rack.

Technical Support

International

- ◆ For online technical support – including troubleshooting, documentation, and software updates: <http://support.aten.com>
- ◆ For telephone support, see *Telephone Support*, page iv:

North America

Email Support		support@aten-usa.com
Online Technical Support	Troubleshooting Documentation Software Updates	http://www.aten-usa.com/support
Telephone Support		1-888-999-ATEN ext 4988

When you contact us, please have the following information ready beforehand:

- ◆ Product model number, serial number, and date of purchase
- ◆ Your computer configuration, including operating system, revision level, expansion cards, and software
- ◆ Any error messages displayed at the time the error occurred
- ◆ The sequence of operations that led up to the error
- ◆ Any other information you feel may be of help

Specifications

Function	VM0202H	VM0202HB
Video Input		
Interface	2 x HDMI Type A Female (Black)	
Impedance	100 Ω	
Max Distance	5 m	
Video Output		
Interface	2 x HDMI Type A Female (Black)	
Impedance	100 Ω	
Max Distance	15 m	5 m
Video		
Max Data Rate	10.2 Gbps (3.4 Gbps Per Lane)	18.0 Gbps (6.0 Gbps Per Lane)
Max Pixel Clock	340 MHz	600 MHz
Compliance	HDMI (3D, 4K, Deep Color) HDCP 1.4 Compatible Consumer Electronics Control (CEC)	HDMI (3D, 4K, Deep Color) HDCP 2.2 Compatible Consumer Electronics Control (CEC)
Max Resolution	Up to 4096 x 2160 / 3840 x 2160 @ 60 Hz (4:2:0); 4096 x 2160 / 3840 x 2160 @ 30 Hz (4:4:4)	4096 x 2160 / 3840 x 2160 @ 60 Hz (4:4:4)
Max Distance	Up to 15 m	Up to 5 M
Control		
RS-232	Connector: 1 x DB-9 Female (Black) Baud Rate and Protocol: Baud Rate: 19200 Data Bits: 8 Stop Bits: 1 Parity: No Flow Control: No	
USB	1 x Micro USB; F/W Upgrade	
IR	1 x Mini Stereo Jack Female (Black)	
EDID Settings	EDID Modes: Default / Port1 / Remix	
Power		
Connectors	1 x DC Jack (Black)	

Function	VM0202H	VM0202HB
Consumption	DC5V:4.3W:20BTU	DC5V:2.47W:11BTU
Environmental		
Operating Temperature	0 - 40° C	0 - 40° C
Storage Temperature	-20 - 60° C	-20 - 60° C
Humidity	0 - 80% RH, Non-Condensing	0 - 80% RH, Non-Condensing
Physical Properties		
Housing	Metal	Metal
Weight	0.58 kg (1.28 lb)	0.60 kg (1.32 lb)
Dimensions (L x W x H)	20.00 x 7.60 x 4.20 cm (7.87 x 2.99 x 1.65 in)	20.00 x 7.60 x 4.20 cm (7.87 x 2.99 x 1.65 in)

ATEN Standard Warranty Policy

Limited Hardware Warranty

ATEN warrants its hardware in the country of purchase against flaws in materials and workmanship for a Warranty Period of two [2] years (warranty period may vary in certain regions/countries) commencing on the date of original purchase. This warranty period includes the [LCD panel of ATEN LCD KVM switches](#). For UPS products, the device warranty is two [2] years but battery is one [1] year. Select products are warranted for an additional year (see [A+ Warranty](#) for further details). Cables and accessories are not covered by the Standard Warranty.

What is covered by the Limited Hardware Warranty

ATEN will provide a repair service, without charge, during the Warranty Period. If a product is defective, ATEN will, at its discretion, have the option to (1) repair said product with new or repaired components, or (2) replace the entire product with an identical product or with a similar product which fulfills the same function as the defective product. Replaced products assume the warranty of the original product for the remaining period or a period of 90 days, whichever is longer. When the products or components are replaced, the replacing articles shall become customer property and the replaced articles shall become the property of ATEN.

To learn more about our warranty policies, please visit our website:
<http://www.aten.com/global/en/legal/policies/warranty-policy/>

© Copyright 2023 ATEN® International Co., Ltd.
Released: 2023-07-07

ATEN and the ATEN logo are registered trademarks of ATEN International Co., Ltd. All rights reserved. All other brand names and trademarks are the registered property of their respective owners.