

# USER'S MANUAL

## **eBOX560-52R-FL Series**

**Embedded System**

**User's Manual**



[www.axiomtek.com](http://www.axiomtek.com)

## **Disclaimers**

This manual has been carefully checked and believed to contain accurate information. Axiomtek Co., Ltd. assumes no responsibility for any infringements of patents or any third party's rights, or any liability arising from such uses.

Axiomtek does not warrant or assume any legal liability or responsibility for the accuracy, completeness or usefulness of any information in this document. Axiomtek does not make any commitment to update any information in this manual.

Axiomtek reserves the right to change or revise this document and/or product at any time without notice.

No part of this document may be reproduced, stored in a retrieval system, or transmitted in any forms or by any means, electronic, mechanical, photocopying, recording, among others, without prior written permissions of Axiomtek Co., Ltd.

**©Copyright 2023 Axiomtek Co., Ltd.**

**All Rights Reserved**

**August 2023, Version A2**

**Printed in Taiwan**

## Safety Precautions

Before getting started, please read the following important safety precautions.

1. The eBOX560-52R-FL does not come with an operating system which must be loaded first before installation of any software into the computer.
2. Be sure to ground yourself to prevent static charge when installing any internal components. Use a wrist grounding strap and place all electronic components in any static-shielded devices. Most electronic components are sensitive to static electrical charge.
3. Disconnect the power cord from the eBOX560-52R-FL prior to making any installation. Be sure both the system and all external devices are turned OFF. Sudden surge of power could ruin sensitive components. Make sure the eBOX560-52R-FL is properly grounded.
4. Make sure the voltage of the power source is correct before connecting it to any power outlet.
5. Turn Off system power before cleaning. Clean the system using a cloth only. Do not spray any liquid cleaner directly onto the screen.
6. Do not leave equipment in an uncontrolled environment where the storage temperature is below  $-40^{\circ}\text{C}$  or above  $80^{\circ}\text{C}$  as it may damage the equipment.
7. Do not open the system's back cover. If opening the cover for maintenance is a must, only a trained technician is allowed to do so. Integrated circuits on computer boards are sensitive to static electricity. To avoid damaging chips from electrostatic discharge, observe the following precautions:
  - Before handling a board or integrated circuit, touch an unpainted portion of the system unit chassis for a few seconds. This will help discharge any static electricity on human body.
  - When handling boards and components, wear a wrist grounding strap available from most electronic component stores.

## **Classifications**

1. Degree of protection against electric shock: not classified
2. Degree of protection against ingress of water: IP40
3. Equipment not suitable for use in the presence of a flammable anesthetic mixture with air, oxygen or nitrous oxide.
4. Mode of operation: Continuous

## General Cleaning Tips

Please keep the following precautions in mind while understanding the details fully before and during any cleaning of the computer and any components within.

A piece of dry cloth is ideal to clean the device.

1. Be cautious of any tiny removable components when using a vacuum cleaner to absorb dirt on the floor.
2. Turn the system off before clean up the computer or any components within.
3. Avoid dropping any components inside the computer or getting circuit board damp or wet.
4. For cleaning, be cautious of all kinds of cleaning solvents or chemicals which may cause allergy to certain individuals.
5. Keep foods, drinks or cigarettes away from the computer.

### Cleaning Tools:

Although many companies have created products to help improve the process of cleaning computer and peripherals, users can also use house hold items accordingly for cleaning. Listed below are items available for cleaning computer or computer peripherals.

Pay special attention to components requiring designated products for cleaning as mentioned below.

- Cloth: A piece of cloth is the best tool to use when rubbing up a component. Although paper towels or tissues can be used on most hardware as well, it is recommended to use a piece of cloth.
- Water or rubbing alcohol: A piece of cloth may be somewhat moistened with water or rubbing alcohol before being rubbed on the computer. Unknown solvents may be harmful to plastic parts.
- Absorb dust, dirt, hair, cigarette and other particles outside of a computer can be one of the best methods of cleaning a computer. Over time these items may restrict the airflow in a computer and cause circuitry to corrode.
- Cotton swabs: Cotton swaps moistened with rubbing alcohol or water are applicable to reach areas in keyboard, mouse and other areas.
- Foam swabs: If possible, it is better to use lint free swabs such as foam swabs.



**【Note】** : *It is strongly recommended that customer should shut down the system before start to clean any single components.*

### Please follow the steps below:

1. Close all application programs;
2. Close operating software;
3. Turn off power switch;
4. Remove all devices;
5. Pull out power cable.

## **Scrap Computer Recycling**

Please inform the nearest Axiomtek distributor as soon as possible for suitable solutions in case computers require maintenance or repair; or for recycling in case computers are out of order.

## **Trademarks Acknowledgments**

Axiomtek is a trademark of Axiomtek Co., Ltd.

IBM, PC/AT, PS/2, VGA are trademarks of International Business Machines Corporation. Intel® and Pentium® are registered trademarks of Intel Corporation.

MS-DOS, Microsoft C and QuickBasic, Windows 10, Windows 8.1, Windows 8, Windows 7, Windows XPE, Windows XP, Windows CE embedded, Linux are trademarks of Microsoft Corporation.

Other brand names and trademarks are the properties and registered brands of their respective owners.

# Table of Contents

---

Disclaimers.....	ii
Safety Precautions.....	iii
Classifications.....	iv
General Cleaning Tips .....	v
Scrap Computer Recycling.....	vi
<b>SECTION 1 INTRODUCTION.....</b>	<b>1</b>
<b>1.1 General Descriptions .....</b>	<b>1</b>
<b>1.2 System Specifications .....</b>	<b>2</b>
1.2.1 CPU .....	2
1.2.2 I/O System .....	3
1.2.3 System Specifications.....	4
1.2.4 Driver Contents .....	5
<b>1.3 Dimensions .....</b>	<b>6</b>
1.3.1 System Dimensions.....	6
1.3.2 Wall-mount Bracket Dimensions.....	7
1.3.3 Din-Rail kit Dimensions.....	8
1.3.4 VESA Mount Dimensions.....	9
<b>1.4 I/O Outlets.....</b>	<b>10</b>
<b>1.5 Packing List.....</b>	<b>11</b>
<b>1.6 Model List.....</b>	<b>12</b>
<b>SECTION 2 HARDWARE INSTALLATION .....</b>	<b>13</b>
2.1 Installation of 2.5" SATA Device .....	13
2.2 Installation of M.2 Wireless Module .....	15
2.3 Installation of DRAM Module.....	16
<b>SECTION 3 JUMPER &amp; CONNECTOR SETTINGS.....</b>	<b>19</b>
<b>3.1 Locations of Jumpers &amp; Connectors.....</b>	<b>19</b>
<b>3.2 Summary of Jumper Settings.....</b>	<b>21</b>
3.2.1 Restore BIOS Optimal Defaults (SW1).....	22
3.2.2 Auto Power On (SSW1) .....	22
<b>3.3 Connectors .....</b>	<b>23</b>
3.3.1 Front Panel .....	24
3.3.2 USB 2.0 Wafer Connector (CN6).....	25
3.3.3 M.2 2230 Key E Connector (CN5).....	26
3.3.4 HDMI Connector (CN11).....	27
3.3.5 USB 3.1 Port (CN9) .....	27
3.3.6 Ethernet Ports (LAN1).....	28
3.3.7 Ethernet Ports (LAN2).....	28
3.3.8 DisplayPort Connector (CN10) .....	30
3.3.9 CMOS Battery Connector (BAT1) .....	30
3.3.10 COM Connectors (SCN3 and SCN4) .....	31
3.3.11 Power and HDD LED Indicator .....	32
3.3.12 System Power Switch .....	32
3.3.13 AC to DC Jack Power In Connector.....	32
3.3.14 SATA Power Connector .....	32

<b>SECTION 4 BIOS SETUP UTILITY</b> .....	<b>33</b>
4.1 Starting .....	33
4.2 Navigation Keys.....	33
4.3 Main Menu .....	34
4.4 Advanced Menu .....	35
4.5 Chipset Menu .....	46
4.6 Security Menu .....	50
4.7 Save & Exit Menu .....	52
<b>APPENDIX A WATCHDOG TIMER</b> .....	<b>55</b>
A.1 About Watchdog Timer.....	55
A.2 How to Use Watchdog Timer.....	55
<b>APPENDIX B iAMT SETTINGS</b> .....	<b>57</b>
C.1 Entering MEBx .....	57
C.2 Set and Change Password .....	57
C.3 iAMT Configuration.....	59
C.4 iAMT Web Console.....	67



# SECTION 1 INTRODUCTION



This section contains general information and detailed specifications of the eBOX560-52R-FL Section 1 consist of the following sub-sections:

- General Descriptions
- System Specifications
- Dimensions
- I/O Outlets
- Packing List
- Model List

## 1.1 General Descriptions

The eBOX560-52R-FL is powered by the high-performance Intel® Core™ i5-8365UE & Intel® Celeron® 4305UE processors (formally code-name: Whiskey Lake U).

The system offers two RS-232/422/485, two USB 3.1 ports, two USB 2.0 ports, two Gigabit Ethernet ports, one DisplayPort++ and HDMI, one AT/ATX quick switch, and two SMA type antenna openings; moreover, it's equipped with one M.2 Key E 2230 slot for Wi-Fi, one SATA drive bay for storage, and one screw-type 12VDC power input connector. To fulfill smart retails, smart cities and factory automation application needs, the high-end ultra-compact size system supports Windows® 10 IoT and it can be wall-mounted, Din-rail mounted and VESA mounted by different applications.

### Features

- Intel® Core™ i5-8305UE 1.6 GHz (quad core) / Intel® Celeron® 4305UE 2.0 GHz (dual core)
- One DisplayPort to support 4K resolution
- Intel® AMT 11 supported
- M.2 Key E 2230 for Wi-Fi
- Ultra-compact size with high performance
- Multiple mounting designs: Wall mount, Din-rail and VESA mount

### Reliable and Stable Design

The embedded system equipped with Intel® Core™ i5-8305UE or Intel® Celeron® 4305UE, ultra-slim size and basic functions. And it also supports different mounting such as wall mount, vertical din rail and VESA mount. It is the best solution for smart retails, light industries and factory automation.

### Flexible Connectivity

It comes with basic interfaces including two RS-232/422/485 ports, two USB 3.1 Gen 2 ports, two USB 2.0 ports, one DisplayPort, one HDMI port (lockable) and two GbE LAN ports.

### Embedded O.S. Supported

The eBOX560-52R-FL supports Windows® 10 IoT and Linux.

### Easy maintain storage Supported

In terms of storage, the eBOX560-52R-FL supports one SATA HDD/SSD drive bay for storage.

## 1.2 System Specifications

### 1.2.1 CPU

- CPU
  - Intel® Core™ i5-8365UE
  - Intel® Celeron® 4305UE
- Chipset
  - SoC integrated
- BIOS
  - American Megatrends Inc. UEFI (Unified Extensible Firmware Interface) BIOS.
- System Memory
  - One 260-pin DDR4-2400 SO-DIMM socket, up to 32 GB at the maximum.

## 1.2.2 I/O System

- **Display**

- 1 x DisplayPort : Support DP1.2 and DP++.  
The DP resolution is up to 4096x2304 @60Hz.
- 1 x HDMI (lockable) : Support HDMI 1.4a.  
The HDMI resolution is up to 3840x2160 @30Hz.

- **Ethernet**

- 2 x 10/100/1000 Ethernet ports (i210-AT,i219-LM)
- LAN1 : Intel® i219-LM supports 1000/100/10Mbps Gigabit/Fast Ethernet with Wake on-LAN and PXE Boot ROM.
- LAN2: Intel® i210-AT supports 1000/100/10Mbps Gigabit/Fast Ethernet with Wake on-LAN and PXE Boot ROM.

- **USB Ports**

- 2 x USB 2.0
- 2 x USB 3.1 Gen 2

- **Serial Ports**

- 2 x RS-232/422/485 (9-pin D-Sub male connector)

- **Expansion Interface**

- 1 x M.2 Key E 2230

- **Storage**

- 1 x 2.5" SATA HDD Drive bay (max up to 9.5 mm height)

- **Indicator**

- 1 x Green LED as indicator for PWR status
- 1 x Orange LED as indicator for HDD active

- **Switch**

- 1 x ATX PWR switch
- 1 x ATX/AT Quick switch

- **Antenna**

- 2 x SMA type connector openings for antenna

### **1.2.3 System Specifications**

- **Watchdog Timer**
  - 1~65536 seconds or minutes; up to 65535 levels.
- **Power Supply**
  - 12VDC (12V/60W AC to DC adapter)
- **Operation Temperature**
  - -10°C to +50°C (+14°F to +122°F) with 0.7 m/s air flow  
(with W.T. SSD & Memory)
- **Humidity**
  - 10% ~ 95% (non-condensation)
- **Vibration Endurance**
  - IEC 60068-2-27 (with SSD: 50G, half sine, 11 ms duration)
- **Shock Endurance**
  - IEC 60068-2-64 (with SSD: 3Grms STD, random, 5 to 500 Hz, 1 hr/axis)
- **Weight**
  - 0.8 kg (1.76 lb) without package
  - 1.8 kg (3.96 lb) with package
- **Dimension**
  - 141.6 mm (5.57") x 106 mm (4.17") x 55 mm (2.17")

### 1.2.4 Driver Contents

Please download system drivers and user's manual from AXIOMTEK website.

- Chipset
- Graphic
- Ethernet
- Intel® ME
- Serial Patch



**【Note】** : *All specifications and images are subject to change without notice.*

## 1.3 Dimensions

The following diagrams show dimensions and outlines of the eBOX560-52R-FL.

### 1.3.1 System Dimensions

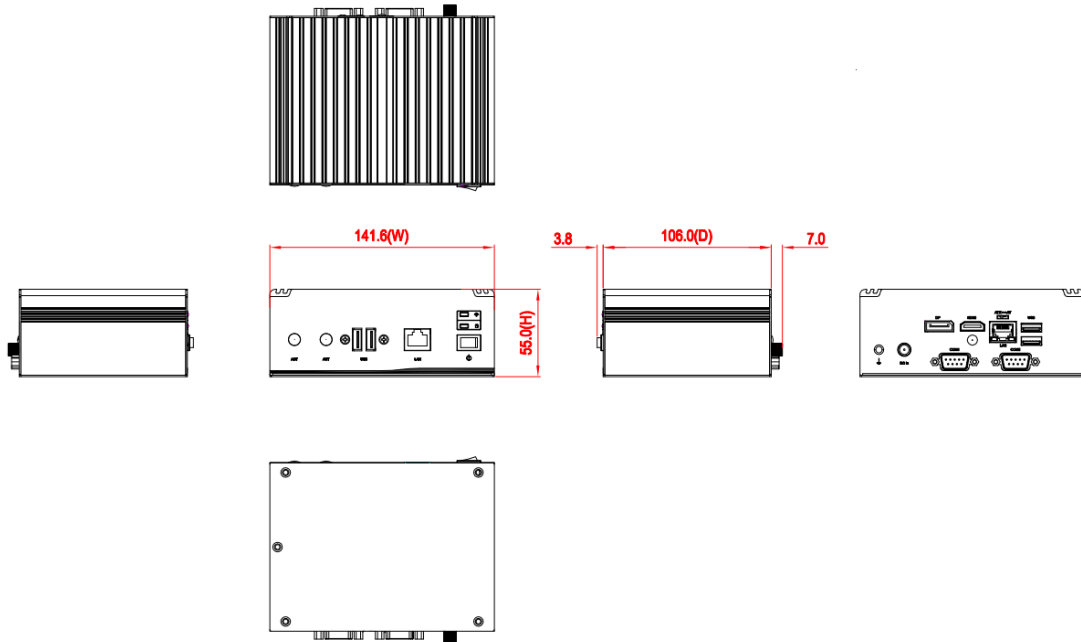

### 1.3.2 Wall-mount Bracket Dimensions

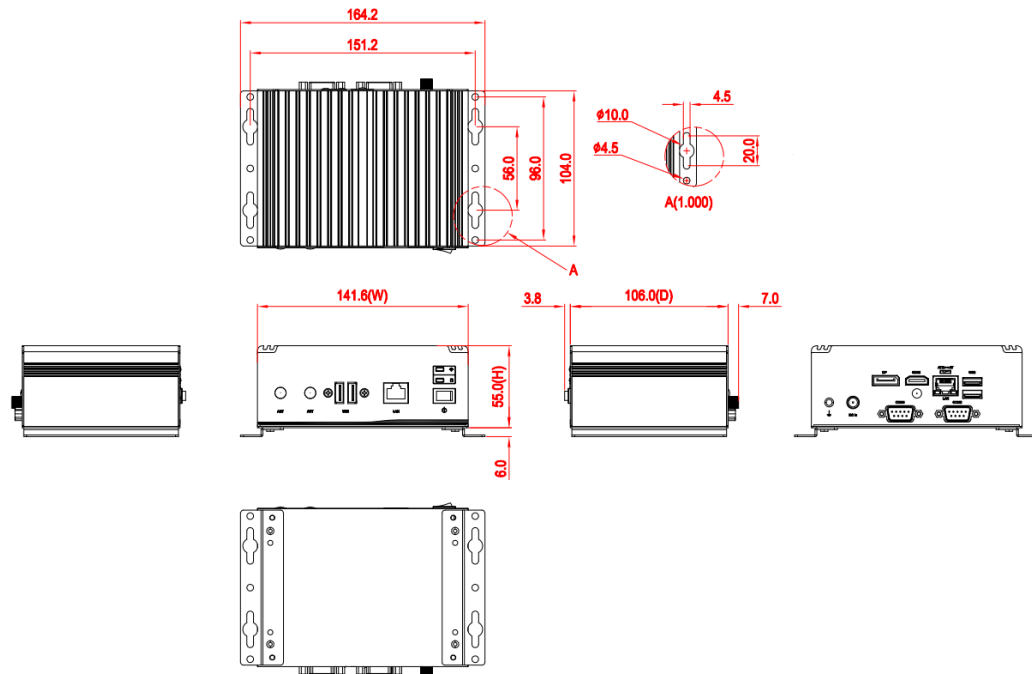

### 1.3.3 Din-Rail kit Dimensions

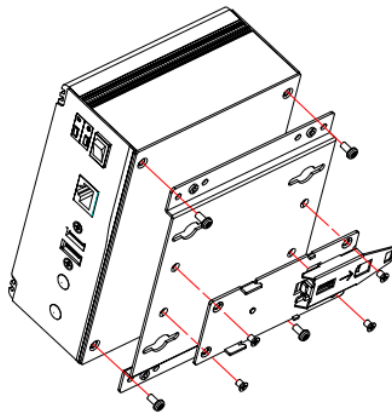
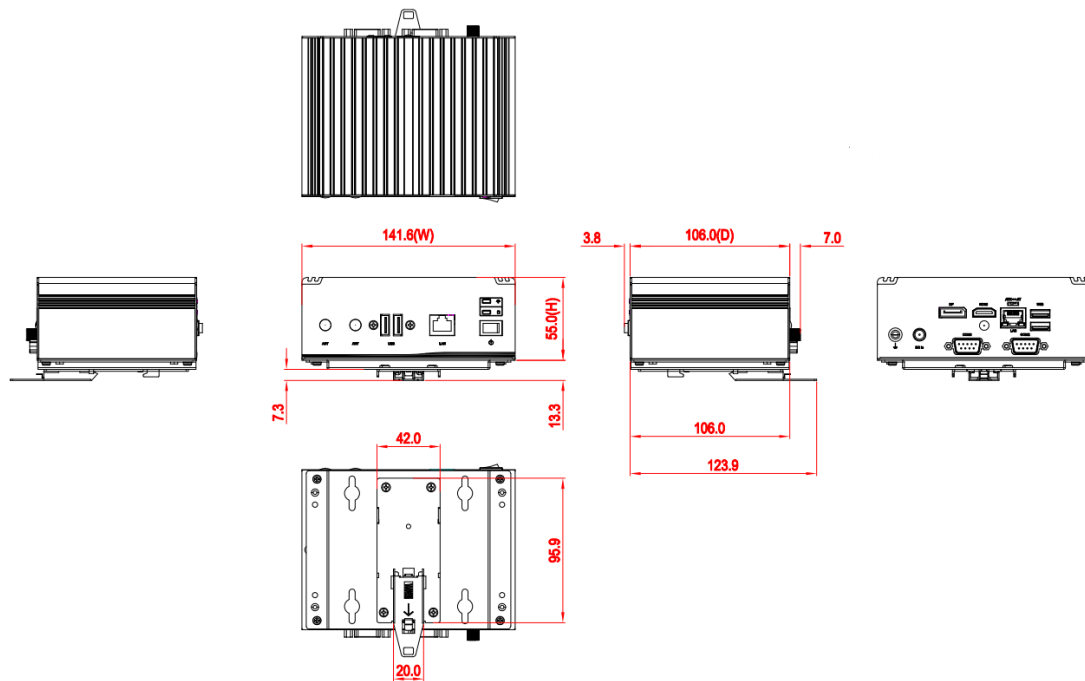



### 1.3.4 VESA Mount Dimensions

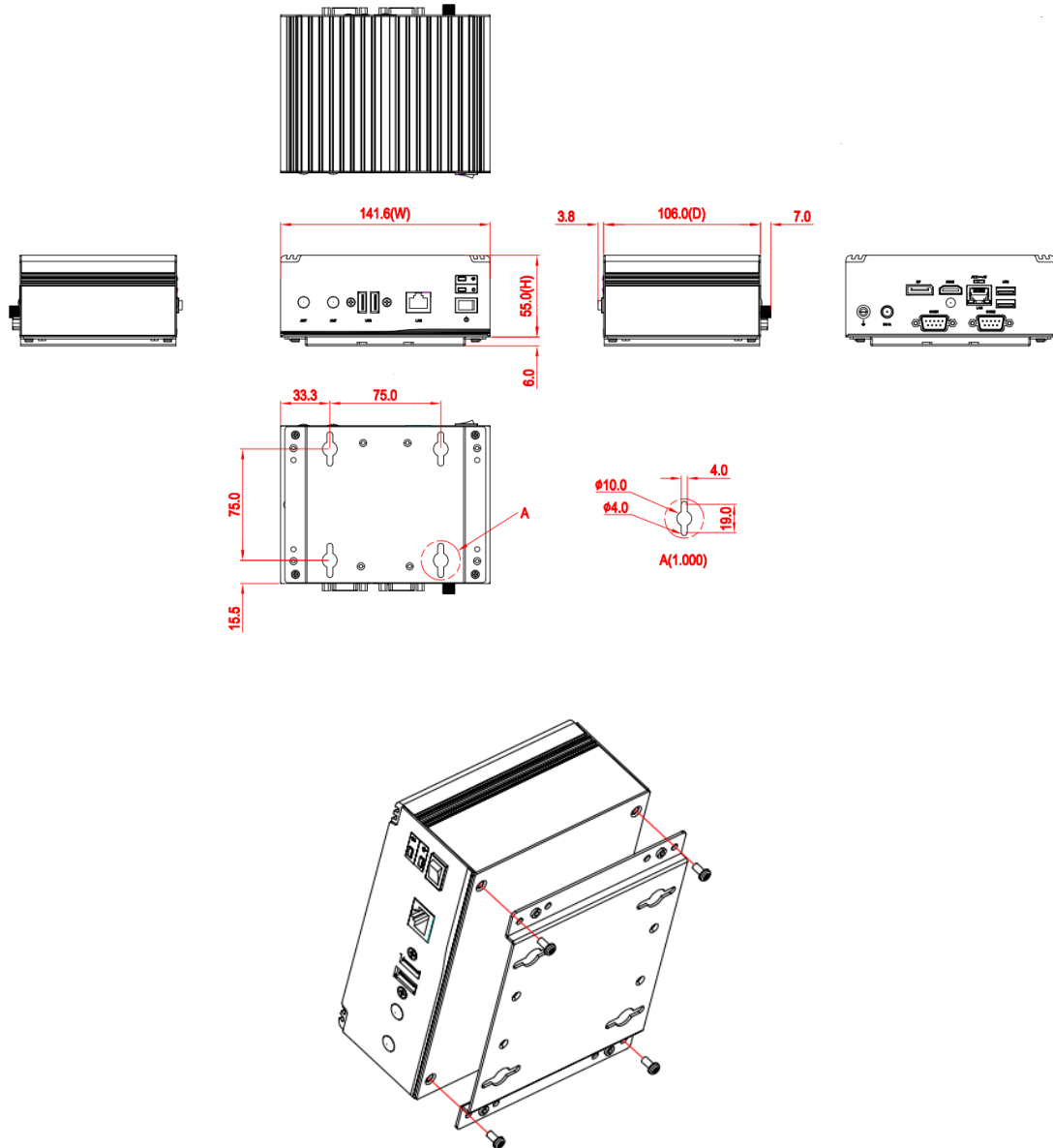

## 1.4 I/O Outlets

The following figures show I/O outlets on the eBOX560-52R-FL.

Front View

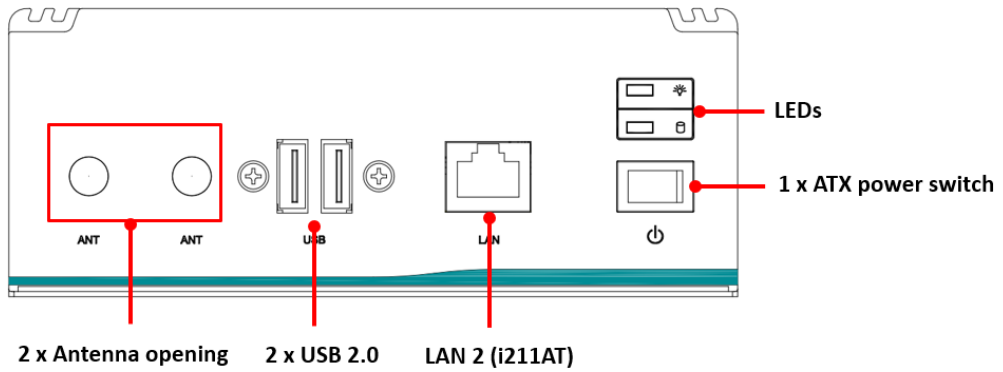

Rear View

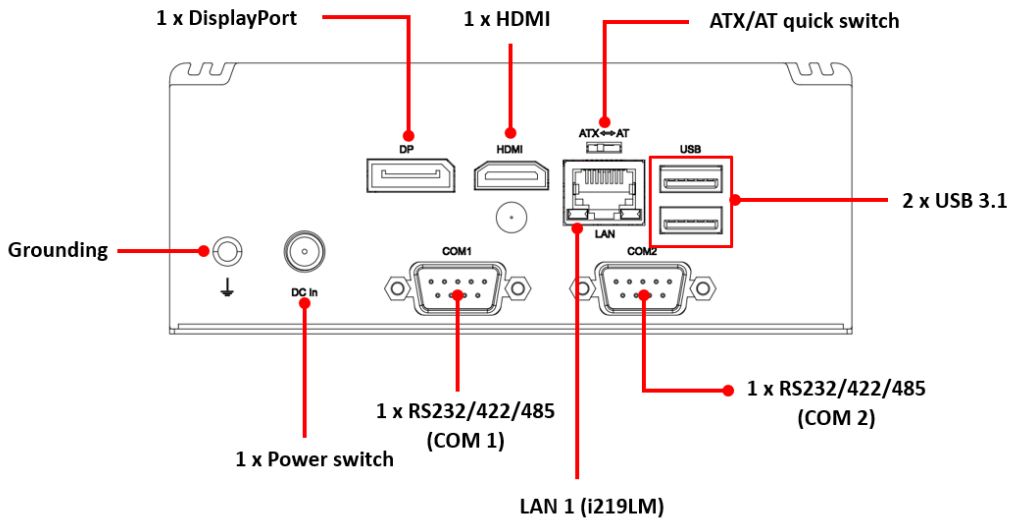

## **1.5 Packing List**

The eBOX560-52R-FL comes with the following bundle package:

- eBOX560-52R-FL System Unit x 1
- Foot Pad x 4
- Screw Pack x 1
- HDD bracket x 1
- DRAM thermal pad Bracket x 1
- DRAM thermal pad x 2

***Note : Please download User's manual from the web site.***

## **1.6 Model List**

eBOX560-52R-FL-DC-8365UE	Fanless embedded system with Intel® i5-8365UE, HDMI/DisplayPort, 2 GbE LAN, 2 COM, 4 USB and 12 VDC
eBOX560-52R-FL-DC-4305UE	Fanless embedded system with Intel® Celeron 4305UE, HDMI/DisplayPort, 2 GbE LAN, 2 COM, 4 USB and 12 VDC

Please contact Axiomtek's distributors immediately in case any abovementioned items are missing.

## SECTION 2 HARDWARE INSTALLATION

The eBOX560-52R-FL is convenient for various hardware configurations, such as DRAM, M.2 Section 2 contain guidelines for hardware installation.

### 2.1 Installation of 2.5" SATA Device

**Step 1** Turn off the system and unplug the power cord.

**Step 2** Turn the system to the backside and then loosen five screws.

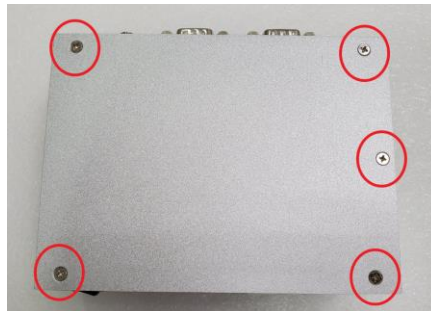

**Step 3** Open the bottom cover and prepare the SSD/HDD and bracket from the accessory box.

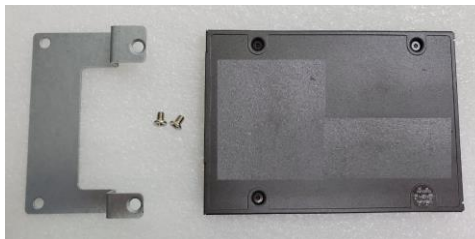

**Step 4** Assembly the SSD/HDD with the two HDD mounting screws and connect the SATA cable. Be sure the PCB side of the SSD/HDD facing to left.

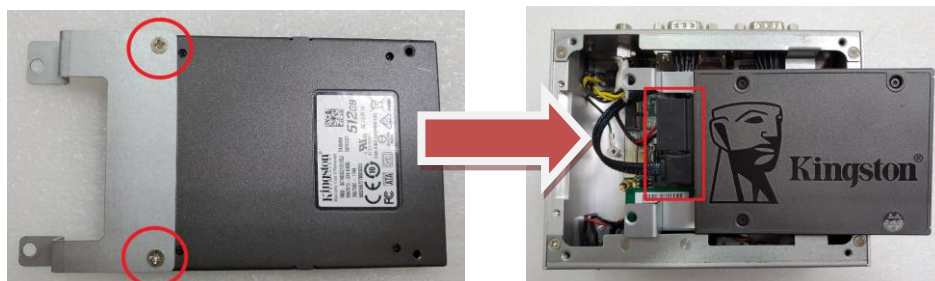

**Step 5 Fasten the HDD/SSD bracket into the chassis.**



**Step 6 Put the bottom cover back and fasten all of screws.**

## 2.2 Installation of M.2 Wireless Module

**Step 1** Turn off the system and unplug the power cord.

**Step 2** Turn the system to the backside and then loosen five screws.

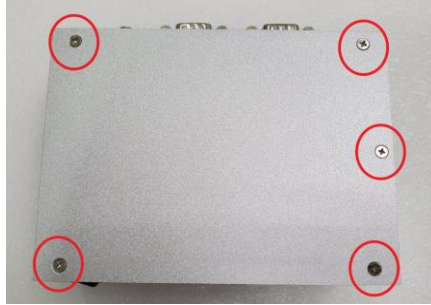

**Step 3** Open the bottom cover and Locate M.2 2230 key E connector within the red line as marked.



**Step 4** Insert the M.2 WiFi module firmly and fasten the screw.



**Step 5** Put the bottom cover back and fasten all of screws.

## 2.3 Installation of DRAM Module

**Step 1** Turn off the system and unplug the power cord.

**Step 2** Turn the system to the backside and then loosen five screws.

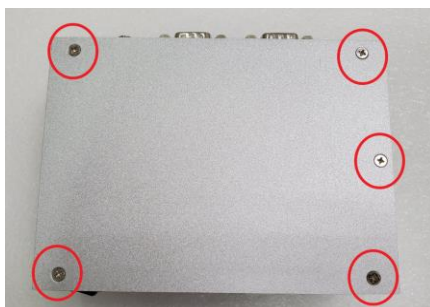

**Step 3** Open the bottom cover and locate the memory module.



**Step 4** Prepare the thermal pad \*2, bracket \*1 and screws\*2 from the accessory box.

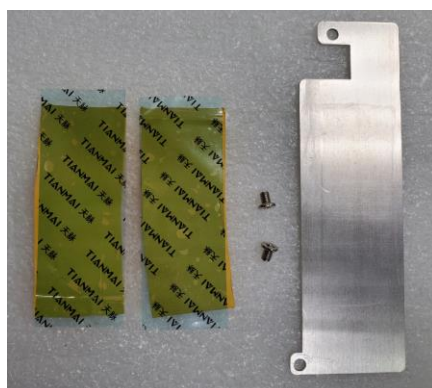

**Step 5** Put the thermal pad on both up and down side of the DRAM.





**Step 6** Insert a gold-colored contact into the socket and push the module two end latches till locked and then fasten the thermal pad bracket on top of the DRAM.

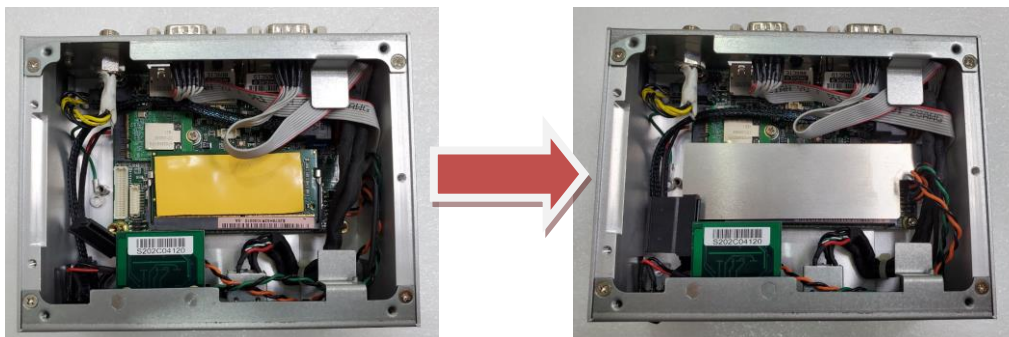

**Step 7** Put the bottom cover back and fasten all of screws.

**This page is intentionally left blank.**

## SECTION 3 JUMPER & CONNECTOR SETTINGS

Proper jumper settings configure the eBOX560-52R-FL to meet various application needs. Hereby all jumper settings along with their default settings are listed for devices onboard.

### 3.1 Locations of Jumpers & Connectors

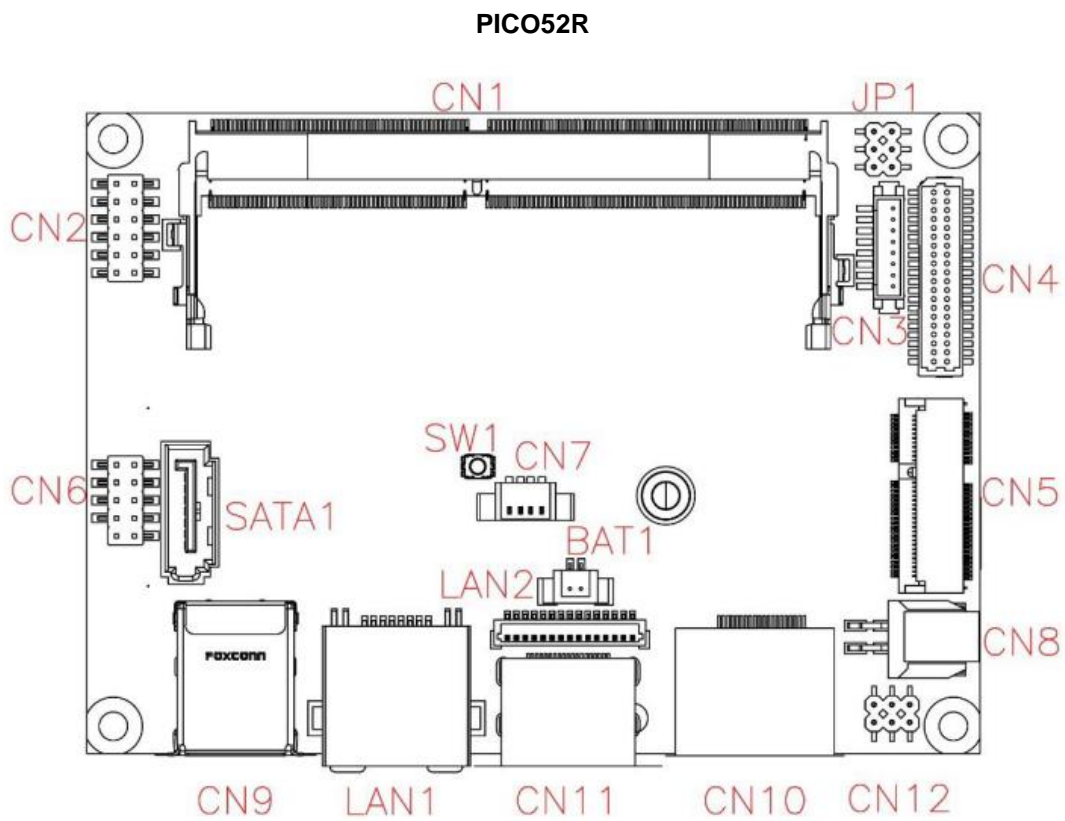

Top View

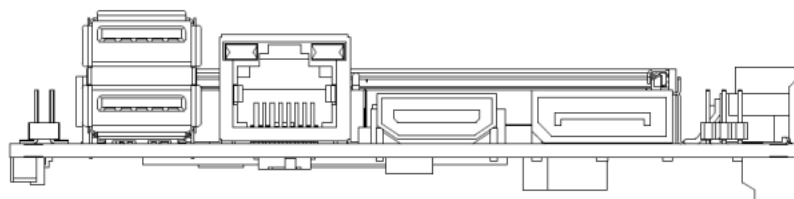

Rear IO

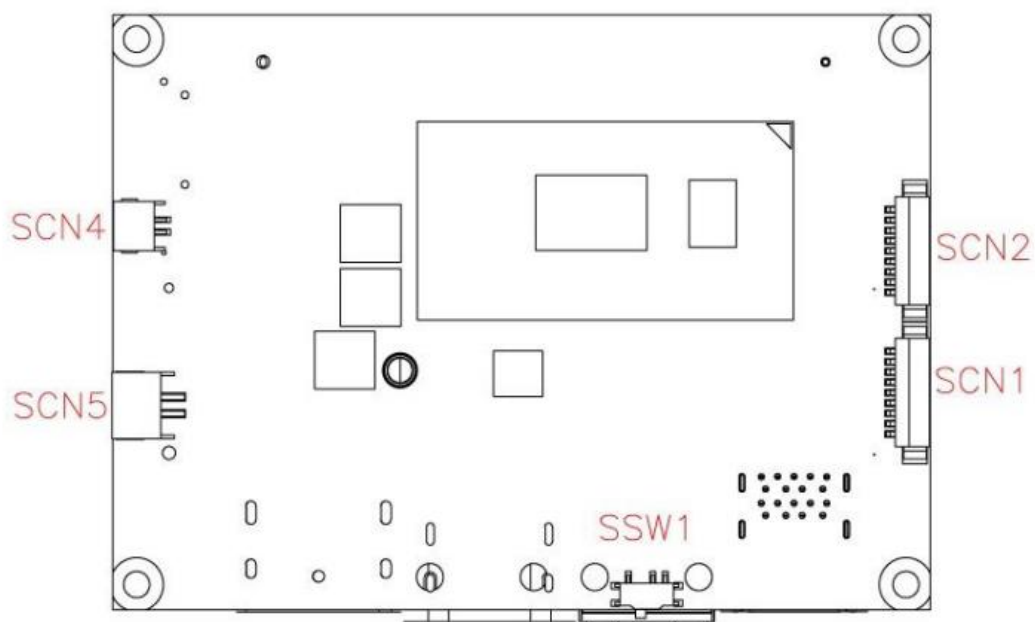

Bottom side

 **【Note】** : *It is strongly recommended that any unmentioned jumper settings should not be modified without instructions by Axiomtek FAEs. Any modifications without instructions might cause system failure.*

## 3.2 Summary of Jumper Settings

Proper jumper settings configure the eBOX560-52R-FL to meet various application purposes. A table of all jumpers and their default settings is listed below.

Jumper and Switch	Descriptions	Settings
SW1	Restore BIOS Optimal Defaults Default: Normal Operation	Release
SWW1	Auto Power On Default: Enable	2-3 Close



### 【Note】 : How to setup Jumpers

That a cap on a jumper is to “close” the jumper, whereas that offs a jumper is to “open” the jumper.

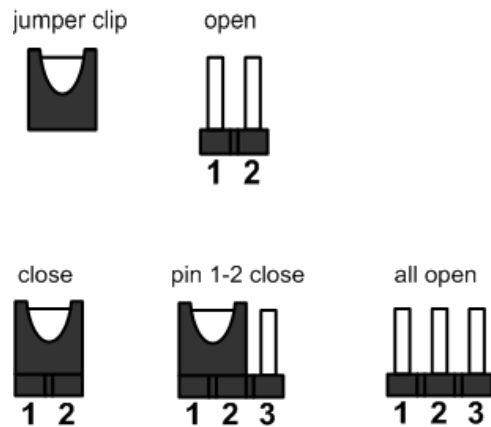

【Note】 : *Once the default jumper or switch setting needs to be changed, please do it under power-off condition.*

### 3.2.1 Restore BIOS Optimal Defaults (SW1)

Use SW1 to clear CMOS. Press the tact switch for at least 3 second to restore BIOS optimal defaults.

Functions	Settings
Normal (Default)	Release
Restore BIOS optimal defaults	Press

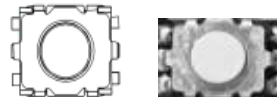

### 3.2.2 Auto Power On (SSW1)

If SSW1 is enabled for power input, the system will be automatically power on without pressing soft power button. If SSW1 is disabled for power input, it is necessary to manually press soft power button to power on the system.

Functions	Settings
Disable auto power on	1-2 close
Enable auto power on (Default)	2-3 close



### 3.3 Connectors

Please refer to pin assignments below:

<b>Connectors</b>	<b>Descriptions</b>
CN1	DDR4 SO-DIMM Connector
CN2	Front Panel Connector
CN5	M.2 2230 Key E Connector
CN6	USB 2.0 Wafer Port 3 and 4
CN8	Power Connector
CN9	USB 3.1 Port
CN10	DisplayPort Connector
CN11	HDMI Connector
LAN1(i219-LM)	Ethernet Port
LAN2 (i210-AT)	Ethernet Wafer Connector
SATA1	SATA Port
BAT1	CMOS Battery Connector
SCN, SCN4	COM1 and COM2 Wafer Connectors
SCN5	SATA Power Connector

### 3.3.1 Front Panel

This is a 2x6-pin header (pitch=2.0mm) for front panel interface.

Pin	Signal	Pin	Signal
1	EXT SPK+	2	EXT SPK-
3	GND	4	PWR_PSON
5	PWRLED-	6	PWRLED+
7	PWRSW-	8	PWRSW+
9	HW RST-	10	HW RST+
11	HDDLED-	12	HDDLED+

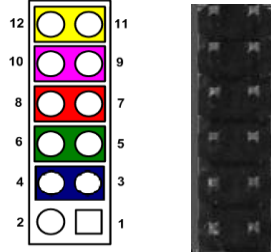

#### External Speaker

Pin 1(+) and 2(-) connect the case-mounted speaker unit or internal buzzer cable. It is strongly recommended to connect with the matching cable, 594H3186800E.

#### Power Status

Pin 4 and pin 3 are for power status button; letting user know the power status of this board.

#### Power LED

Pin 6 connects anode (+) of LED and pin 5 connects cathode (-) of LED. The power LED lights up when the system is powered on.

#### Power On/Off Button

Pin 8 and 7 connect the power button on front panel to CPU board, which allows users to turn on or off power supply.

#### System Reset Switch

Pin 10 and 9 connect the case-mounted reset switch that reboots your computer without turning off the power switch. It is a better way to reboot your system for a longer life of system power supply.

#### HDD Activity LED

This connection is linked to hard drive activity LED on the control panel. LED flashes when HDD is being accessed. Pin 12 and 11 connect the hard disk drive to the front panel HDD LED, pin 11 is assigned as cathode(-) and pin 12 is assigned as anode(+).



### 3.3.2 USB 2.0 Wafer Connector (CN6)

This is a 2x5-pin cut pin 9 (pitch=2.0mm) wafer connector, which is compliant with Hirose DF11-10DP-2DSA, for installing versatile USB 2.0 compliant interface peripherals.

Pin	Signal	Pin	Signal
1	+5V_SBY	2	+5V_SBY
3	USB #3_D-	4	USB #4_D-
5	USB #3_D+	6	USB #4_D+
7	GND	8	GND
		10	GND

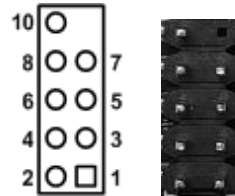

### 3.3.3 M.2 2230 Key E Connector (CN5)

The CN5 is a M.2 2230 Key E connector. It is suggested to install the M.2 wireless module via PCIe x1 with 22mm width and 30mm length.

Pins	Signals	Pins	Signals
1	GND	2	+3.3V_SBY
3	USB2_DP5	4	+3.3V_SBY
5	USB2_DN5	6	NC
7	GND	8	NC
9	NC	10	NC
11	NC	12	NC
13	NC	14	NC
15	NC	16	NC
17	NC	18	GND
19	NC	20	NC
21	NC	22	NC
23	NC	24	Key E
25	Key E	26	
27		28	
29		30	
31		32	
33	GND	34	NC
35	PCI5_TXP	36	NC
37	PCI5_TXN	38	NC
39	GND	40	NC
41	PCI5_RXP	42	NC
43	PCI5_RXN	44	NC
45	GND	46	NC
47	PCI5_CLKP5	48	NC
49	PCI5_CLKN5	50	SUSCLK (+3.3V Level)
51	GND	52	PLTRST_2_N (+3.3V Level)
53	CLKREQ#_P CIE5	54	W_DIS2# (+3.3V Level)
55	PCI5_WAKE _N	56	W_DI12# (+3.3V Level)
57	GND	58	SMBDAT_3P3_SB Y
59	NC	60	SMBCLK_3P3_SB Y
61	NC	62	SMBALERT#_3P3 _SBY
63	GND	64	NC
65	NC	66	NC
67	NC	68	NC
69	GND	70	NC
71	NC	72	+3.3V_SBY
73	NC	74	+3.3V_SBY
75	GND		

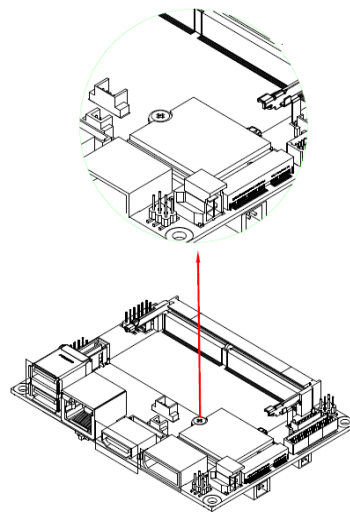
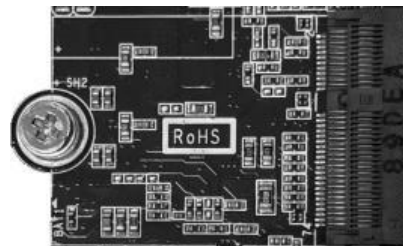
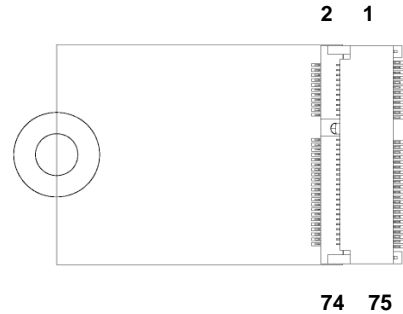

**Note**

After installing the M.2 Key E card, please screw and lock the card. It is suggested to install M.2 Key E card before DDR4 module on SO-DIMM

### 3.3.4 HDMI Connector (CN11)

The HDMI (High-Definition Multimedia Interface) is a compact digital interface which is capable of transmitting high-definition video and high-resolution audio over a single cable. Its interface is available through connector CN11.

Pins	Signals	Pins	Signals
1	HDMI OUT_DATA2+	2	GND
3	HDMI OUT_DATA2-	4	HDMI OUT_DATA1+
5	GND	6	HDMI OUT_DATA1-
7	HDMI OUT_DATA0+	8	GND
9	HDMI OUT_DATA0-	10	HDMI OUT_Clock+
11	GND	12	HDMI OUT_Clock-
13	N.C.	14	N.C.
15	HDMI OUT_SCL	16	HDMI OUT_SDA
17	GND	18	+5V
19	HDMI_HTPLG		

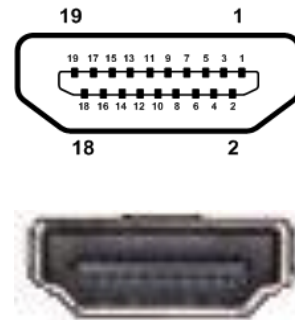

### 3.3.5 USB 3.1 Port (CN9)

The board comes with two Universal Serial Bus (compliant with USB 3.1 Gen2 (10Gb/s)) type A connectors for installing USB peripherals such as keyboard, mouse, scanner, etc.

Pins	Signals	Pins	Signals
1	+5V	10	+5V
2	USB_Data1-	11	USB_Data2-
3	USB_Data1+	12	USB_Data2+
4	GND	13	GND
5	SSRX1-	14	SSRX2-
6	SSRX1+	15	SSRX2+
7	GND	16	GND
8	SSTX1-	17	SSTX2-
9	SSTX1+	18	SSTX2+

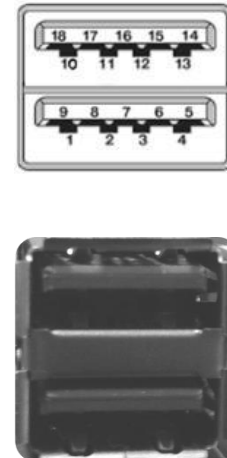

### 3.3.6 Ethernet Ports (LAN1)

The system has one RJ-45 Ethernet connector for LAN1 with Intel® gigabit Ethernet controller i219-LM. Ethernet connection can be established by plugging one end of the Ethernet cable into this connector and the other end (phone jack) to a 1000/100/10-Base-T hub.

Pins	1000 Base-T	100/10 Base-T	Descriptions
L1	BI_DA+	TX+	Bidirectional or Transmit Data+
L2	BI_DA-	TX-	Bidirectional or Transmit Data-
L3	BI_DB+	RX+	Bidirectional or Receive Data+
L4	BI_DC+	N.C.	Bidirectional or Not Connected
L5	BI_DC-	N.C.	Bidirectional or Not Connected
L6	BI_DB-	RX-	Bidirectional or Receive Data-
L7	BI_DD+	N.C.	Bidirectional or Not Connected
L8	BI_DD-	N.C.	Bidirectional or Not Connected
A	Active Link LED (Yellow) Off: No link Blinking: Data activity detected		
B	Speed LED 1000: Orange 100/10: Green/OFF		

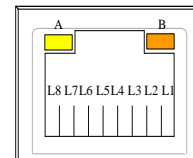
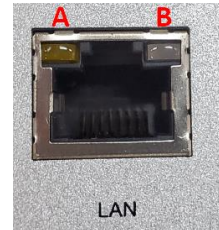

### 3.3.7 Ethernet Ports (LAN2)

The system has one RJ-45 Ethernet connector for LAN2 with Intel® gigabit Ethernet controller i210-AT via flat cable.

Pins	1000 Base-T	100/10 Base-T	Descriptions
L1	BI_DA+	TX+	Bidirectional or Transmit Data+
L2	BI_DA-	TX-	Bidirectional or Transmit Data-
L3	BI_DB+	RX+	Bidirectional or Receive Data+
L4	BI_DC+	N.C.	Bidirectional or Not Connected
L5	BI_DC-	N.C.	Bidirectional or Not Connected
L6	BI_DB-	RX-	Bidirectional or Receive Data-
L7	BI_DD+	N.C.	Bidirectional or Not Connected
L8	BI_DD-	N.C.	Bidirectional or Not Connected
A	Active Link LED (Yellow) Off: No link Blinking: Data activity detected		
B	Speed LED 1000: Orange 100/10: Green/OFF		

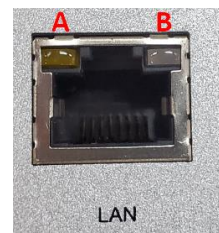

There is a 15-pin (pitch=1.0mm) wafer connector which is compliant with JST BM15B-SRSS-TB for Ethernet port interface.

Pins	Signals
1	GND
2	LAN_LINK_ACT
3	LAN_VDD33
4	GND
5	MDI0+
6	MDI0-
7	MDI1+
8	MDI2+
9	MDI2-
10	MDI1-
11	MDI3+
12	MDI3-
13	GND
14	LAN_100_LED-
15	LAN_1000_LED-

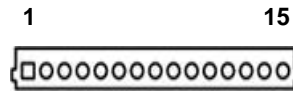

### 3.3.8 DisplayPort Connector (CN10)

The DisplayPort interface is available through connector CN10.

Pin	Signal
1	DPB_LANE0
2	GND
3	DPB_LANE0#
4	DPB_LANE1
5	GND
6	DPB_LANE1#
7	DPB_LANE2
8	GND
9	DPB_LANE2#
10	DPB_LANE3
11	GND
12	DPB_LANE3#
13	Detect Pin
14	GND
15	DPB_AUX
16	GND
17	DPB_AUX#
18	DPB_HPDP
19	GND
20	+3.3V

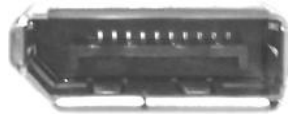
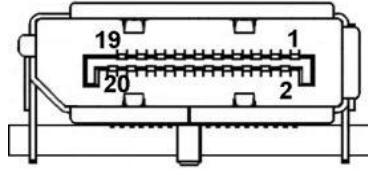

### 3.3.9 CMOS Battery Connector (BAT1)

This is a 2-pin (pitch=1.25mm) wafer connector for CMOS battery interface.

Pin	Signal
1	BAT1(+3V level)
2	GND



### 3.3.10 COM Connectors (SCN3 and SCN4)

The system supports 2 ports DB9 RS-232/422/485 which can be selected by BIOS.

There is a 9-pin (pitch=1.25mm) connector which is compliant with Molex 53047-0910.

The SCN3 and SCN4 are for COM2 and COM1 interfaces, respectively. Both COM1 and COM2 support RS-232/422/485, for further information please refer to BIOS setting in section 4.4. The pin assignments of RS-232/422/485 are listed in table below.

#### COM1:

Pins	RS-232	RS-422	RS-485
1	GND	GND	GND
2	RI1	No use	No use
3	DTR1	RX1-	No use
4	CTS1	No use	No use
5	TX1	RX1+	No use
6	RTS1	No use	No use
7	RX1	TX1+	Data+
8	DSR1	No use	No use
9	DCD1	TX1-	Data-

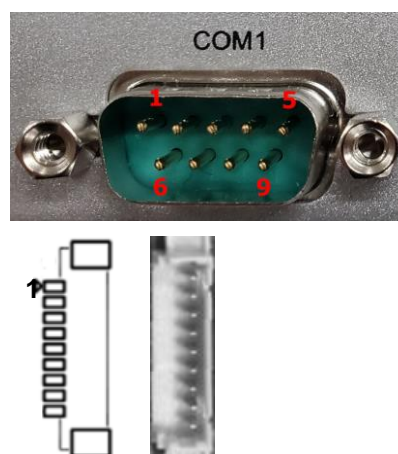

#### COM2:

Pins	RS-232	RS-422	RS-485
1	GND	GND	GND
2	RI2	No use	No use
3	DTR2	RX2-	No use
4	CTS2	No use	No use
5	TX2	RX2+	No use
6	RTS2	No use	No use
7	RX2	TX2+	Data+
8	DSR2	No use	No use
9	DCD2	TX2-	Data-

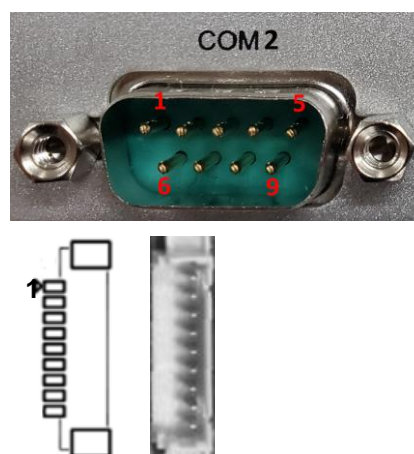

### 3.3.11 Power and HDD LED Indicator

The Yellow LED is linked to Hard Disk Drive (HDD) activity signal. LED flashes every time HDD is accessed. The power LED (Green) lights up and will remain steady while the system is powered on.

LED Color	Description
Green	Power on/off
Orange	Hard disk drive activity

PWR  
○  
HDD  
○

### 3.3.12 System Power Switch

This button is for turning on/off the system power.

Functions	Descriptions
On	Turn on/off system
Off	Keep system status



### 3.3.13 AC to DC Jack Power In Connector

The system supports a DC12V DC-jack connector for system power input.

Connect it to the power AC-DC 12V/60W adapter (optional)

Pin	Signal
1	+12V
2	GND



### 3.3.14 SATA Power Connector

This is a 2-pin (pitch=2.0mm) wafer connector for 5V/1A DC power output.

Pins	Signals
1	+V5S
2	GND

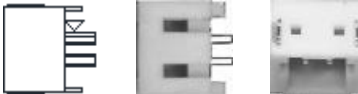



## SECTION 4 BIOS SETUP UTILITY

This section provides users with detailed descriptions in terms of how to set up basic system configurations through the BIOS setup utility.

### 4.1 Starting

To enter the setup screens, follow the steps below:

1. Turn on the computer and press the <Del> key immediately.
2. After press the <Del> key, the main BIOS setup menu displays. Users can access to other setup screens, such as the Advanced and Chipset menus, from the main BIOS setup menu.

It is strongly recommended that users should avoid changing the chipset's defaults. Both AMI and system manufacturer have carefully set up these defaults that provide the best performance and reliability.

### 4.2 Navigation Keys

The BIOS setup/utility uses a key-based navigation system called hot keys. Most of the BIOS setup utility hot keys can be used at any time during the setup navigation process. These keys include <F1>, <F2>, <Enter>, <ESC>, <Arrow> keys, and so on.



**【Note】** : *Some of the navigation keys differ from one screen to another.*

Hot Keys	Descriptions
→← Left/Right	The Left and Right <Arrow> keys allow users to select a setup screen.
↑↓ Up/Down	The Up and Down <Arrow> keys allow users to select a setup screen or sub-screen.
+– Plus/Minus	The Plus and Minus <Arrow> keys allow users to change the field value of a particular setup item.
Tab	The <Tab> key allows users to select setup fields.
F1	The <F1> key allows users to display the General Help screen.
F2	The <F2> key allows users to Load Previous Values.
F3	The <F3> key allows users to Load Optimized Defaults.
F4	The <F4> key allows users to save any changes they made and exit the Setup. Press the <F4> key to save any changes.
Esc	The <Esc> key allows users to discard any changes they made and exit the Setup. Press the <Esc> key to exit the setup without saving any changes.
Enter	The <Enter> key allows users to display or change the setup option listed for a particular setup item. The <Enter> key can also allow users to display the setup sub- screens.

### 4.3 Main Menu

The Main Menu screen is the first screen users see when entering the setup utility. Users can always return to the Main setup screen by selecting the Main tab. System Time/Date can be set up as described below. The Main BIOS setup screen is also shown below.

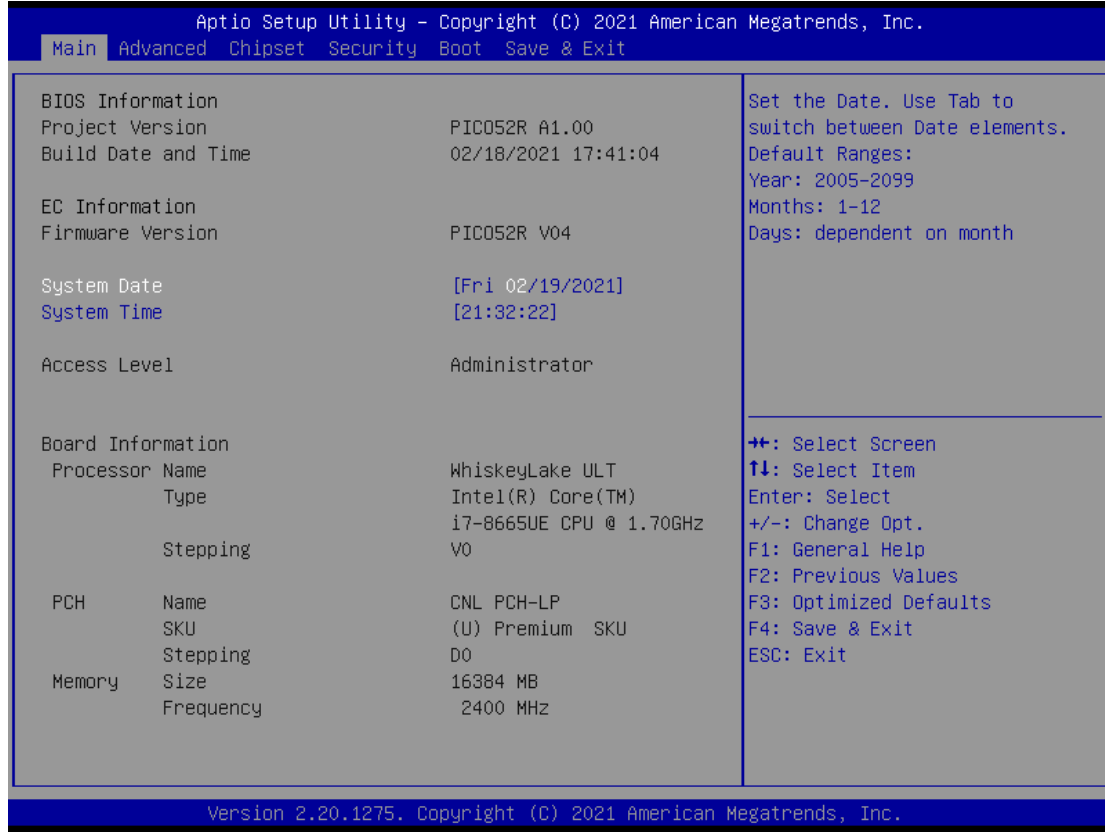

#### BIOS & EC Information

Display BIOS and EC firmware information.

#### System Date/Time

Use this option to change the system time and date. Highlight System Time or System Date using the <Arrow> keys. Enter new values through the keyboard. Press the <Tab> key or the <Arrow> keys to move between fields. The date must be entered in MM/DD/YY format. The time is entered in HH:MM:SS format.

#### Access Level

Display the access level of current user.

#### Processor Information

Display processor information.

## 4.4 Advanced Menu

The Advanced menu also allows users to set configuration of the CPU and other system devices. Users can select any items in the left frame of the screen to go to sub menus:

- ▶ Serial Port Configuration
- ▶ Hardware Monitor
- ▶ ACPI Settings
- ▶ CPU Configurations
- ▶ SATA Configurations
- ▶ PCH-FW Configurations
- ▶ AMT Configurations
- ▶ USB Configurations

For items marked with “▶”, please press <Enter> for more options.



## Serial Port Configurations

Users can use this screen to select options for the Serial Port Configuration, and change the value of the selected option. A description of the selected item appears on the right side of the screen. For items marked with “ ”, please press <Enter> for more options.

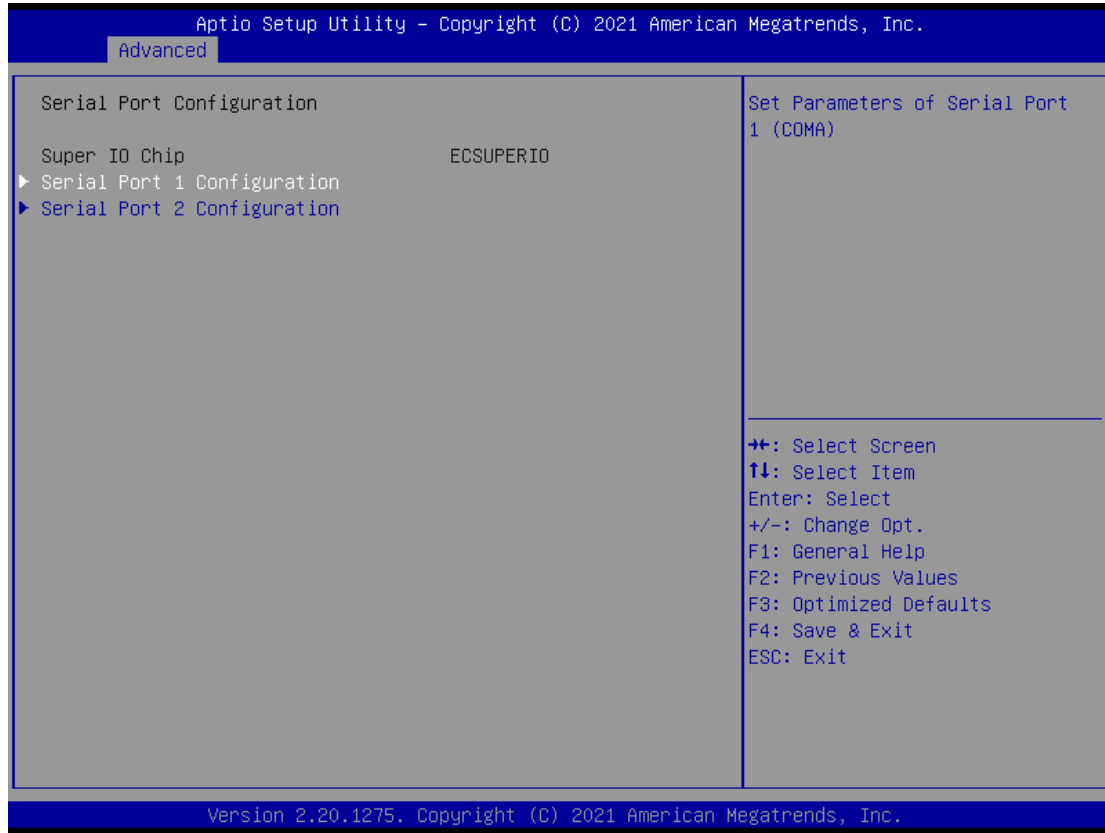

### Serial Port 1~2 Configuration

Use these items to set parameters related to serial port 1~2.

## Serial Port 1 Configuration

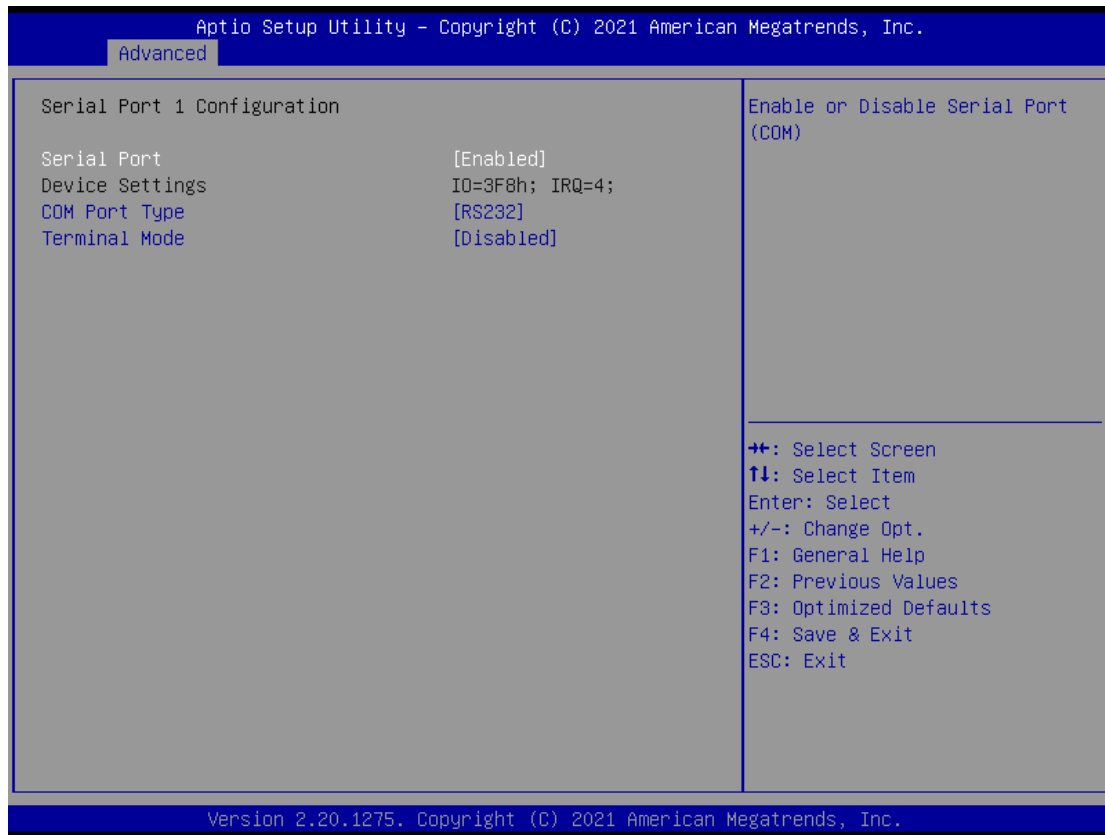

### Serial Port

Enable or disable serial port 1. The optimal setting for base I/O address is 3F8h and for interrupt request address is IRQ4.

### COM Port Type

Use this item to set RS-232/422/485 communication mode.

### Terminal Mode

Enable terminal mode to enable the RS-422/485 termination resistor to enhance the signal.

## Serial Port 2 Configuration

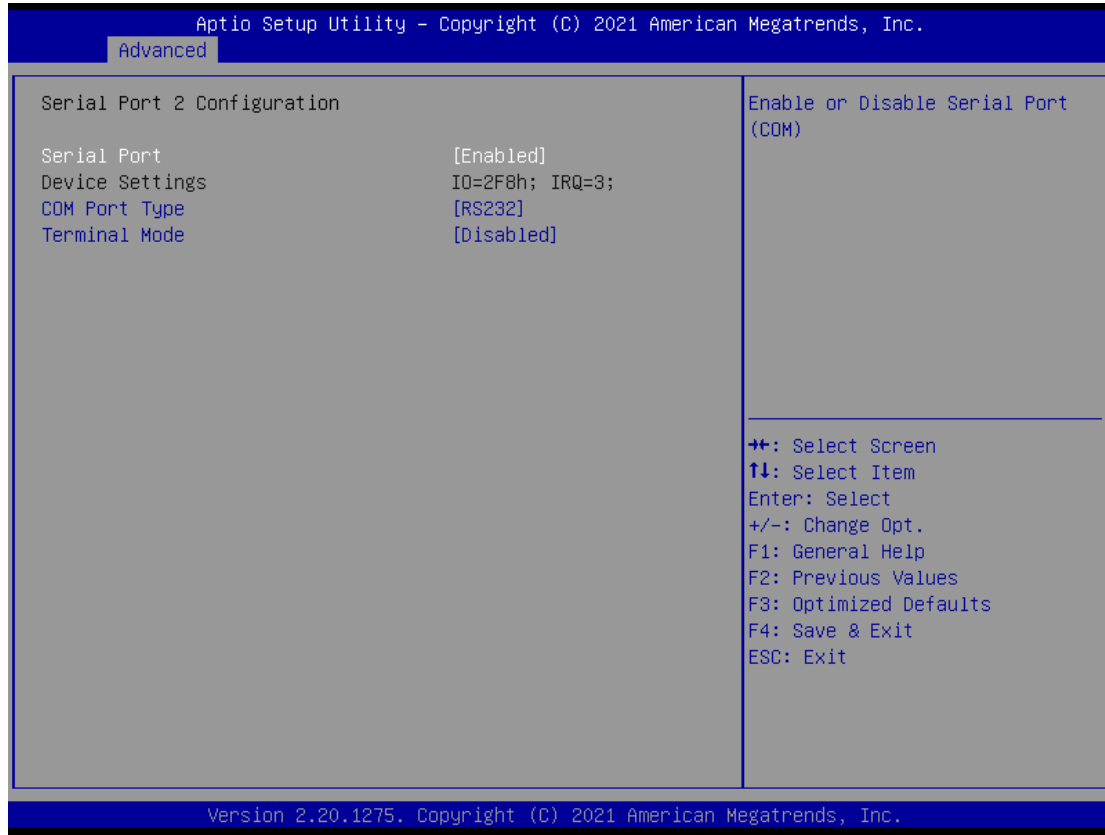

### Serial Port

Enable or disable serial port 2. The optimal setting for base I/O address is 2F8h and for interrupt request address is IRQ3.

### COM Port Type

Use this item to set RS-232/422/485 communication mode.

### Terminal Mode

Enable terminal mode to enable the RS-422/485 termination resistor to enhance the signal.

## Hardware Monitor

This screen monitors hardware health status.

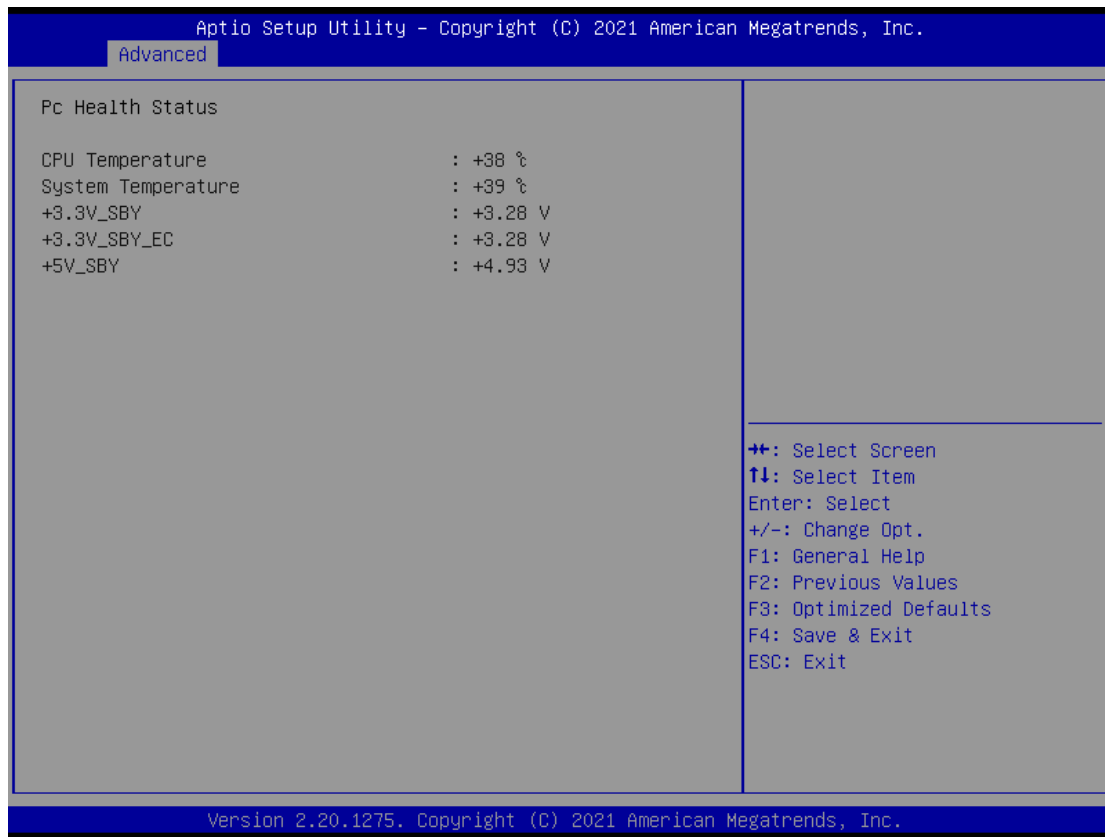

This screen displays the temperature of system and CPU, system voltages (VBAT, +3.3V, +3.3V standby and +5V).

## ACPI Settings

Use this screen to select options for the ACPI configuration, and change the value of the selected option. A description of the selected item appears on the right side of the screen.

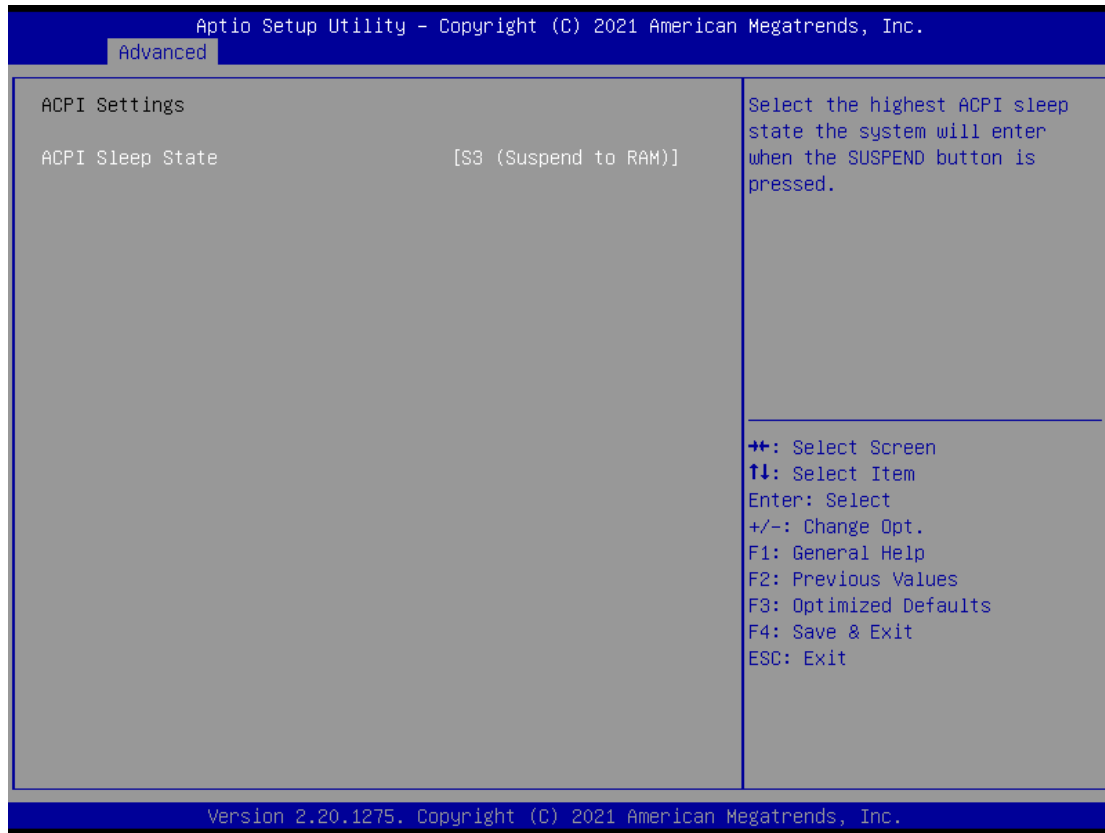

### ACPI Sleep State

Select the ACPI (Advanced Configuration and Power Interface) sleep state. The S3 (Suspend to RAM) option selects ACPI sleep state the system will enter when suspend button is pressed.



## CPU Configurations

This screen shows the CPU version and its detailed information.

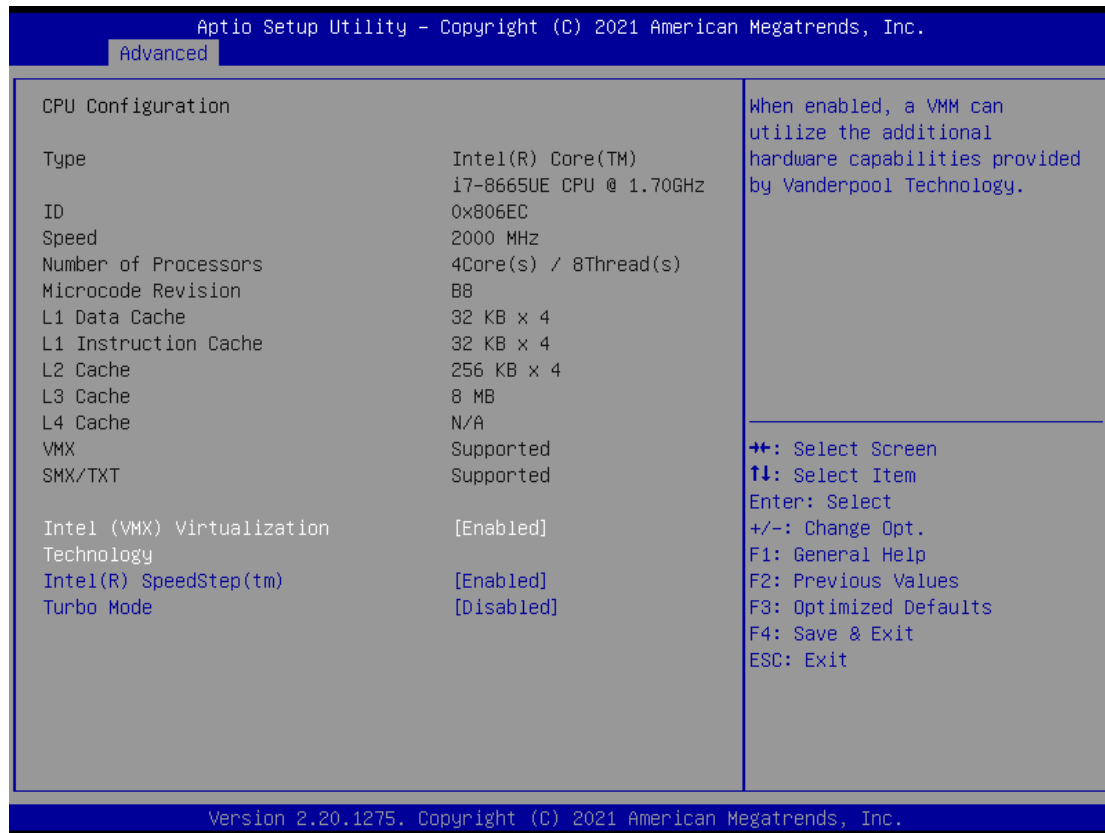

### Intel Virtualization Technology

Enable or disable Intel® Virtualization Technology. When enabled, a VMM (Virtual Machine Mode) can utilize the additional hardware capabilities. It allows a platform to run multiple operating systems and applications independently, hence enabling a computer system to work as several virtual systems.

### Intel SpeedStep

The processor will control the frequency dynamically. When it is enabled, the option of Turbo Mode will be showed.

### Turbo Mode

Enable or disable processor Turbo Mode. The processor can be up to maximum turbo frequency when the system loading becomes higher.

## SATA Configurations

In this Configuration menu, users can see the currently installed hardware in the SATA port. During system boot up, the BIOS automatically detects the presence of SATA device.

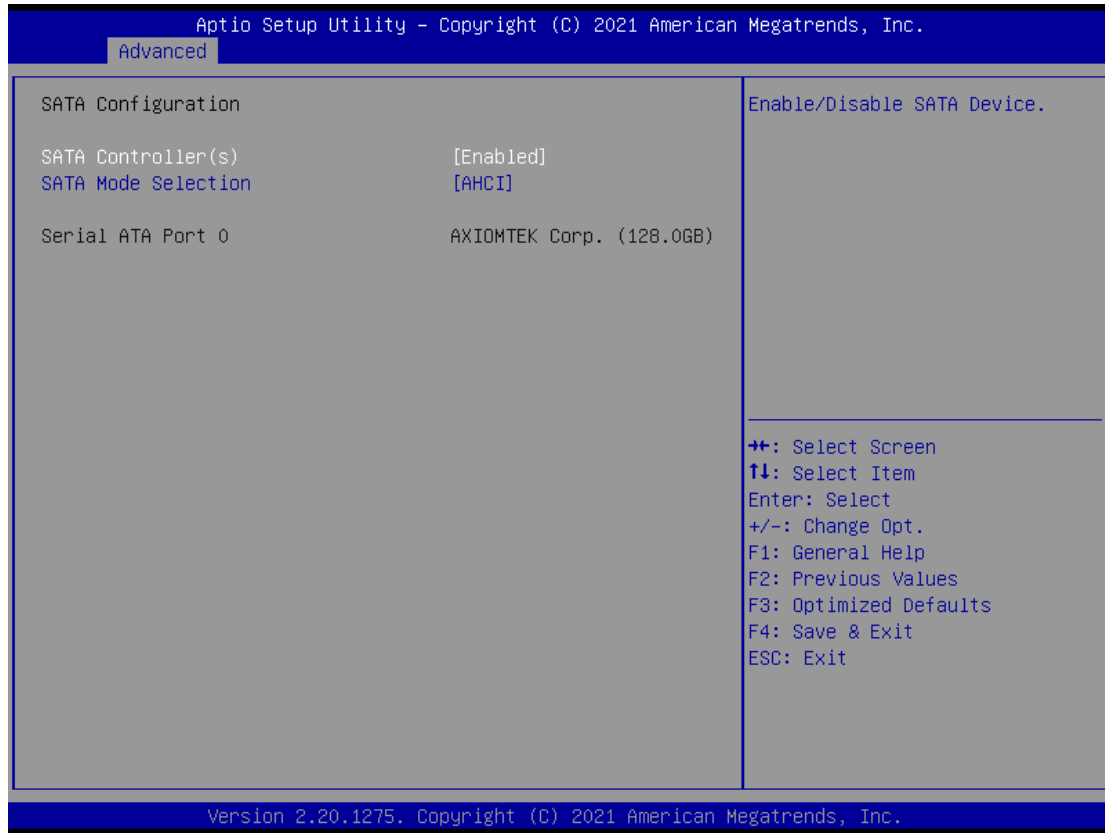

### SATA Controller(s)

Enable or disable the SATA Controller feature. The default is Enabled.

### SATA Mode Selection

Determine how SATA controller(s) operate.

## PCH-FW Configurations

This screen displays ME Firmware information.

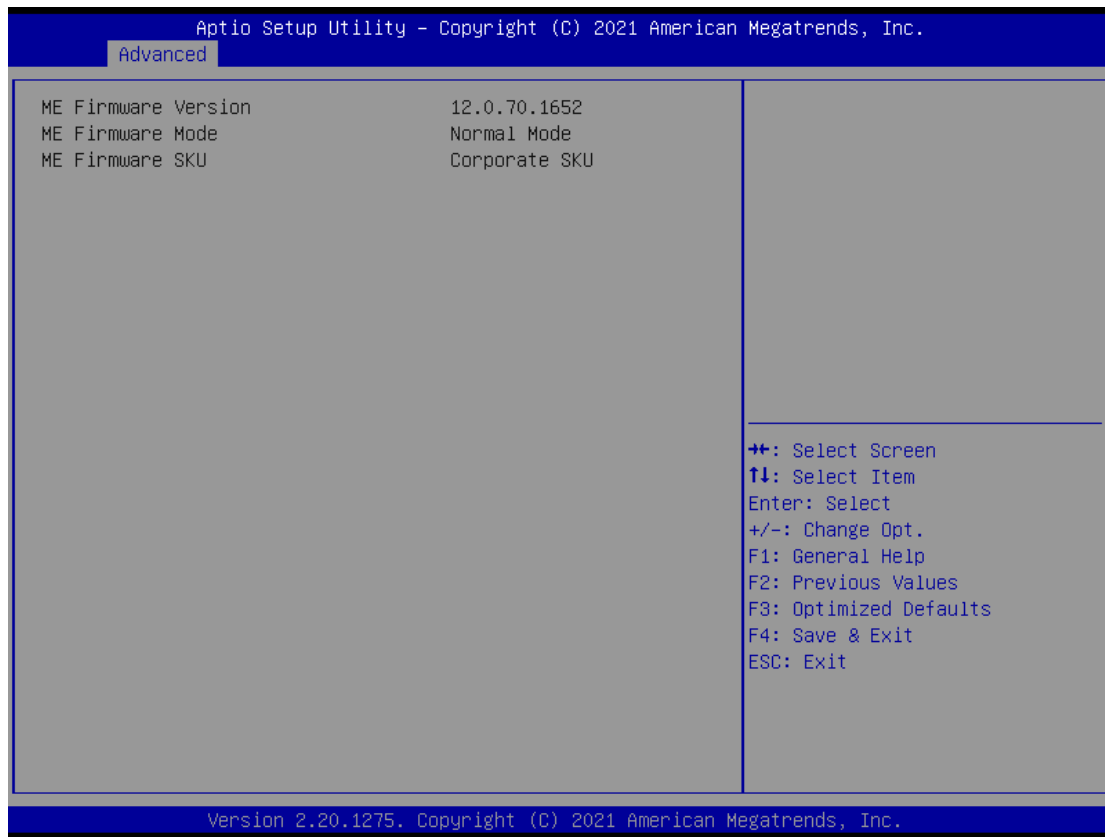

## AMT Configurations

Use this screen to configure AMT parameters..

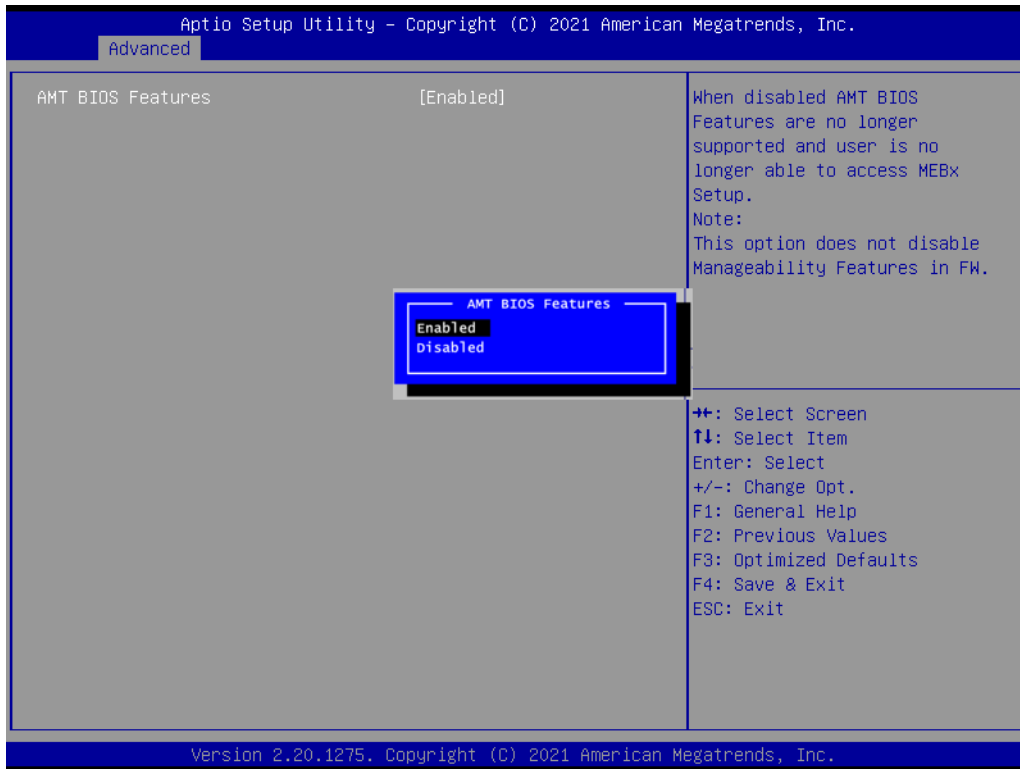

## AMT BIOS Features

Enable or disable Active Management Technology BIOS features. The default is Enabled. Note that this screen will be empty, if the CPU does not support Intel® AMT, see image below.



## USB Configurations

This screen is for BIOS flash utility.

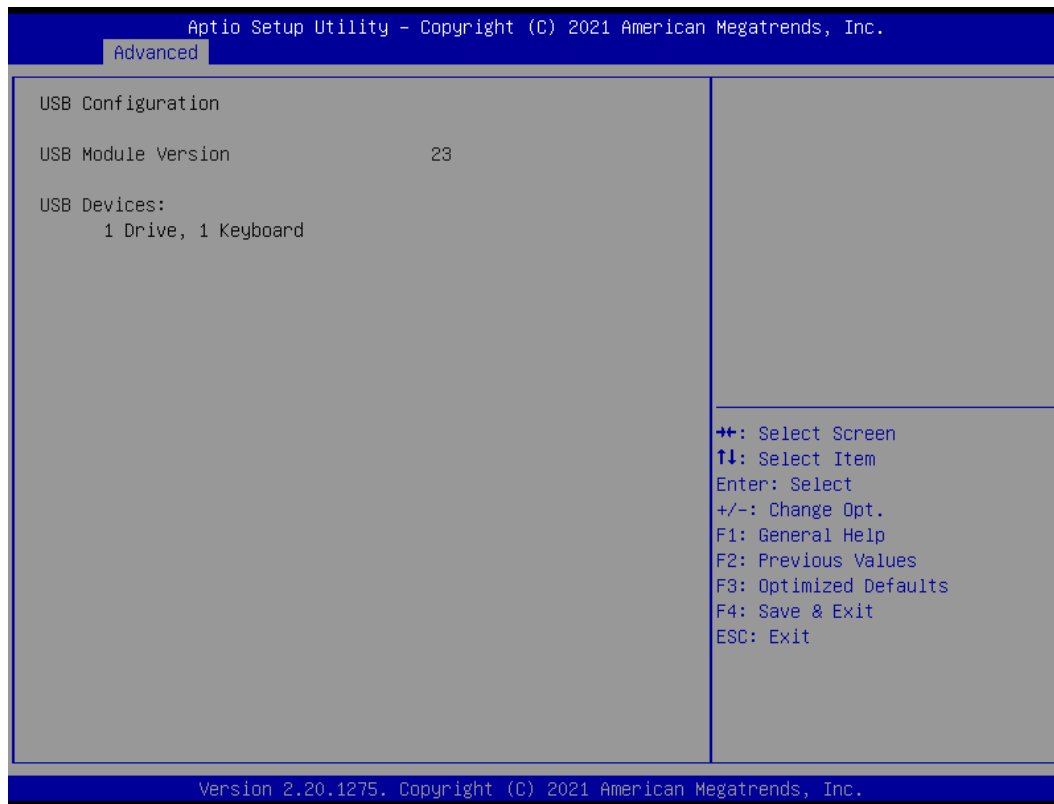

## USB Devices

Display all detected USB devices.

## 4.5 Chipset Menu

The Chipset menu allows users to change the advanced chipset settings. Users can select any of the items in the left ff the screen to go to the sub menus:

- ▶ PCH-IO Configuration
- ▶ System AGENT (SA) Configuration

For items marked with “▶”, please press <Enter> for more options.

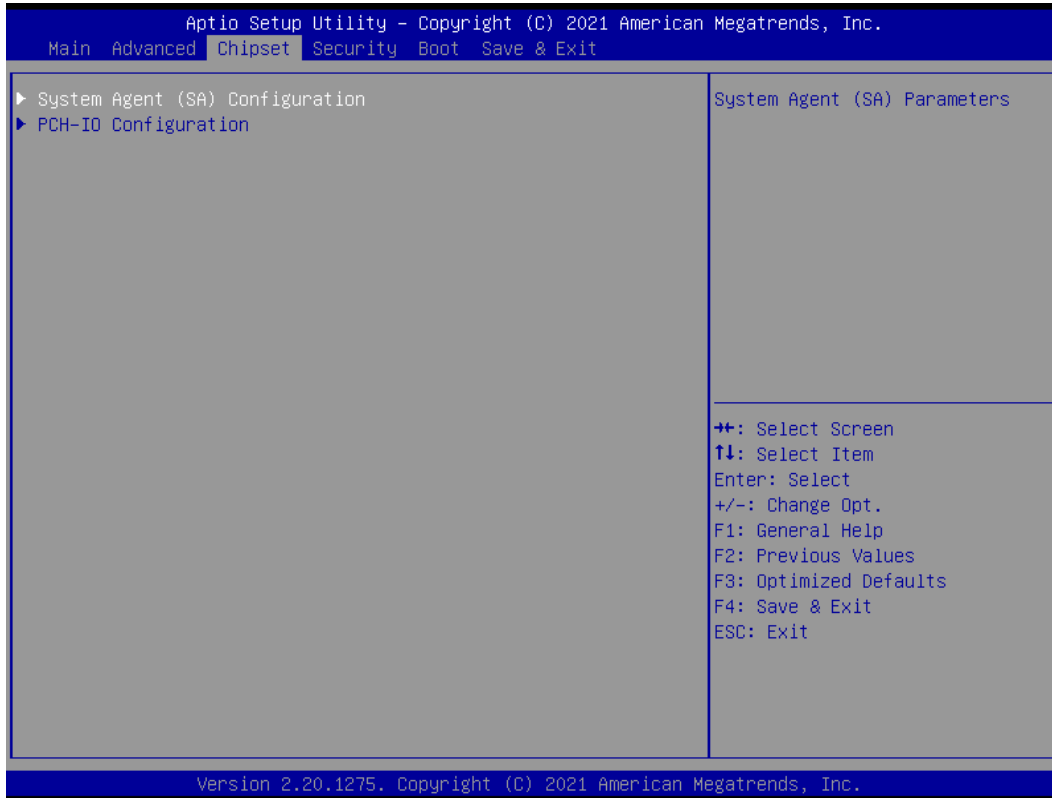

## System Agent(SA) Configuration

This screen allows users to configure System Agent (SA) parameters. For items marked with "▶", please press <Enter> for more options.

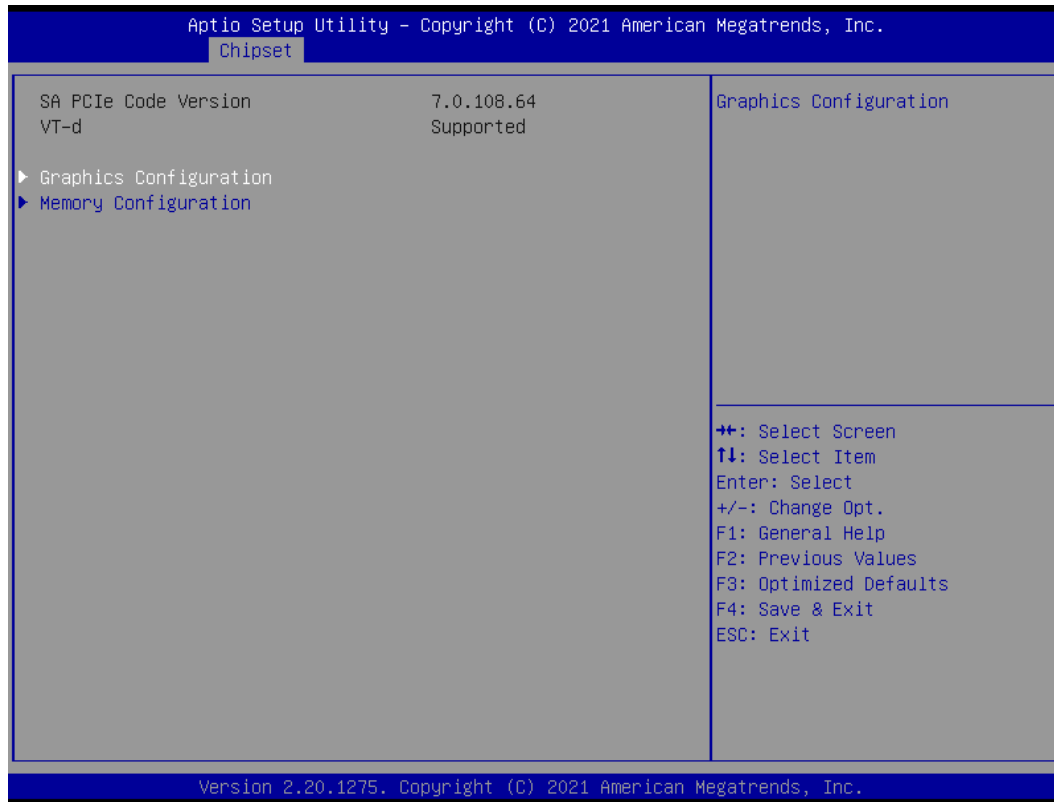

### Graphics Configuration

Open sub menu for parameters related to graphics configuration.

### Memory Configuration

Open sub menu for information related to system memory.

## System Agent(SA) Configuration

This screen shows system memory information.

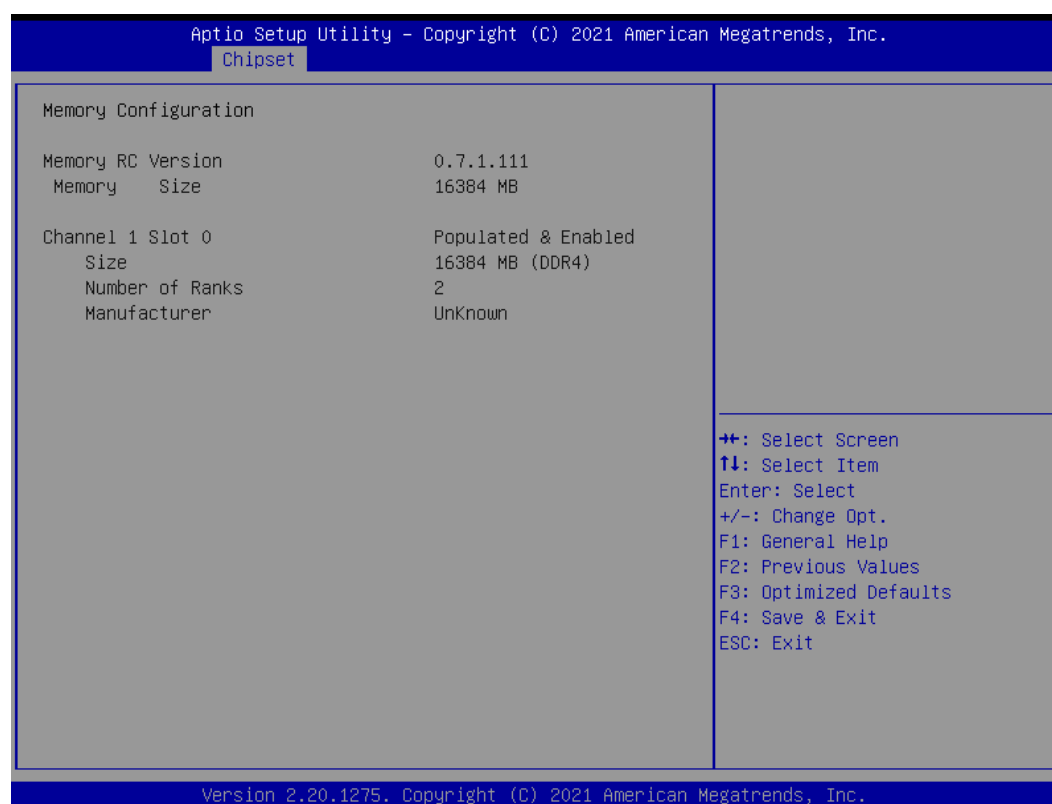



## PCH-IO Configuration

This screen allows users to configure parameters of North Bridge chipset.

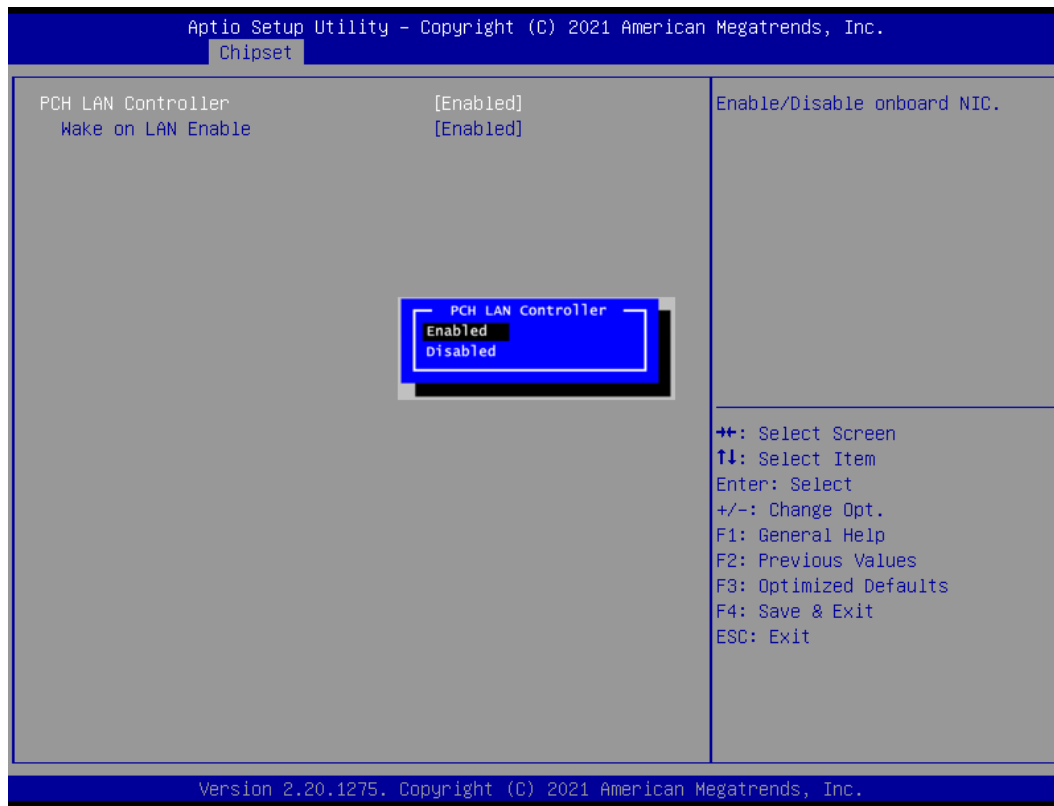

### PCH LAN Controller

Enable or disable onboard PCH LAN controller.

### Wake on LAN Enable

After enabling PCH LAN Controller, enabling or disabling integrated LAN to wake the system.

## 4.6 Security Menu

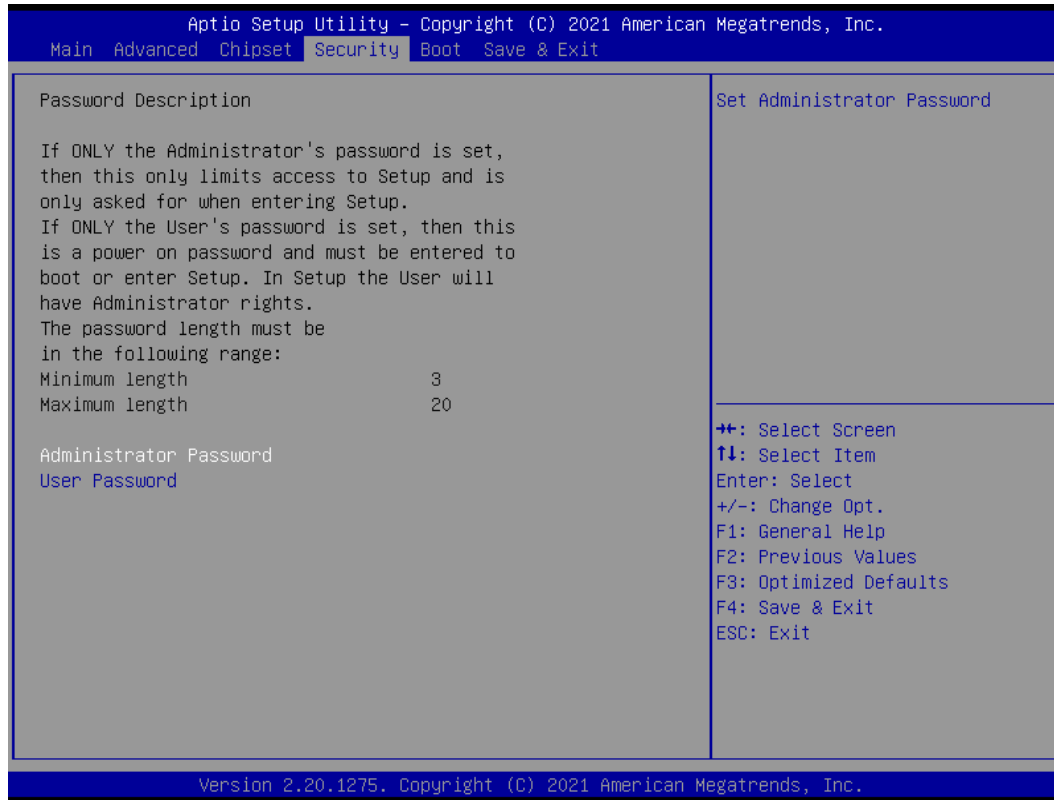

### Administrator Password

This item indicates whether an administrator password has been set (installed or uninstalled).

### User Password

This item indicates whether a user password has been set (installed or uninstalled).

## Boot Menu

The Boot menu allows users to change boot options of the system.



### Setup Prompt Timeout

Number of seconds to wait for setup activation key. 65535(0xFFFF) means indefinite waiting.

### Bootup Numlock State

Use this item to select the power-on state for the keyboard NumLock.

### Launch PXE OpROM policy

Control the execution of UEFI and Legacy Network OpROM.

### Quiet Boot

Select to display either POST output messages or a splash screen during boot-up.

### Boot Option Priorities

These are settings for boot priority. Specify the boot device priority sequence from the available devices.

### Boot Mode

Use this option for boot mode settings.

-UEFI Mode: Select support to boot any UEFI-capable OS.

-Legacy Mode: Select support to boot non UEFI-capable OS that expects a legacy BIOS interface.

## 4.7 Save & Exit Menu

The Save & Exit menu allows users to load system configurations with optimal or fail-safe default values.

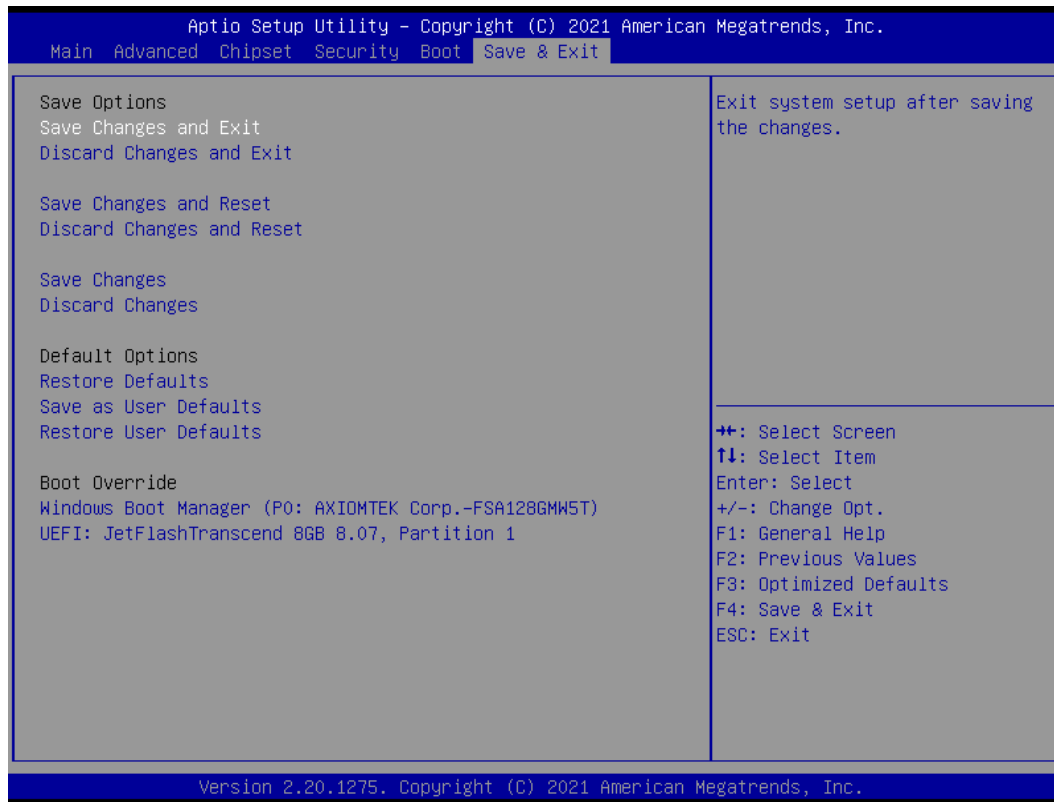

### Save Changes and Exit

When users have completed the system configuration changes, select this option to leave Setup and return to Main Menu. Select Save Changes and Exit from the Save & Exit menu and press <Enter>. Select Yes to save changes and exit.

### Discard Changes and Exit

Select this option to quit Setup without making any permanent changes to the system configurations and return to Main Menu. Select Discard Changes and Exit from the Save & Exit menu and press <Enter>. Select Yes to discard changes and exit.

### Save Changes and Reset

When completed the system configuration changes, select this option to leave Setup and reboot the computer so the new system configurations take effect. Select Save Changes and Reset from the Save & Exit menu and press <Enter>. Select Yes to save changes and reset.

### Discard Changes and Reset

Select this option to quit Setup without making any permanent changes to the system configuration and reboot the computer. Select Discard Changes and Reset from the Save & Exit menu and press <Enter>. Select Yes to discard changes and reset.

### **Save Changes**

When completed the system configuration changes, select this option to save changes. Select Save Changes from the Save & Exit menu and press <Enter>. Select Yes to save changes.

### **Discard Changes**

Select this option to quit Setup without making any permanent changes to the system configurations. Select Discard Changes from the Save & Exit menu and press <Enter>. Select Yes to discard changes.

### **Restore Defaults**

It automatically sets all Setup options to a complete set of default settings when users select this option. Select Restore Defaults from the Save & Exit menu and press <Enter>.

### **Save as User Defaults**

Select this option to save system configuration changes done so far as User Defaults. Select Save as User Defaults from the Save & Exit menu and press <Enter>.

### **Restore User Defaults**

It automatically sets all Setup options to a complete set of User Defaults when users select this option. Select Restore User Defaults from the Save & Exit menu and press <Enter>.

### **Boot Override**

Select a drive to immediately boot that device regardless of the current boot order.

**This page is intentionally left blank.**

## APPENDIX A WATCHDOG TIMER

### A.1 About Watchdog Timer

After the system stops working for a while, it can be auto-reset by the watchdog timer. The integrated watchdog timer can be set up in the system reset mode by program.

### A.2 How to Use Watchdog Timer

Assembly sample code :

```
movdx,fa10; 5 seconds (Maximum is 65535 seconds; fill in
           ; 0xFA10 and 0xFA11 register, ex:
           0xFA11=0x01,
           ; 0xFA10=0x68 means 360 seconds)

movax,05
outdx,ax

movdx,fa12; Enable WDT
movax,01
outdx,ax
```

**This page is intentionally left blank.**



## APPENDIX B

# iAMT SETTINGS

The Intel® Active Management Technology (Intel® iAMT) has decreased a major barrier to IT efficiency that uses built-in platform capabilities and popular third-party management and security applications to allow IT a better discovering, healing, and protection their networked computing assets.

In order to utilize Intel® iAMT you must enter the ME BIOS (<Ctrl + P> during system startup), change the ME BIOS password, and then select “Intel® iAMT” as the manageability feature.

### C.1 Entering MEBx

1. Go to BIOS to enable iAMT function (see section 4.4).
2. Exit from BIOS after starting iAMT, and press <Ctrl + P> to enter MEBx Setting.



*It is better to press <Ctrl + P> before the screen popping out.*

**Note**

### C.2 Set and Change Password

1. You will be asked to set a password when first log in. The default password is “admin”.

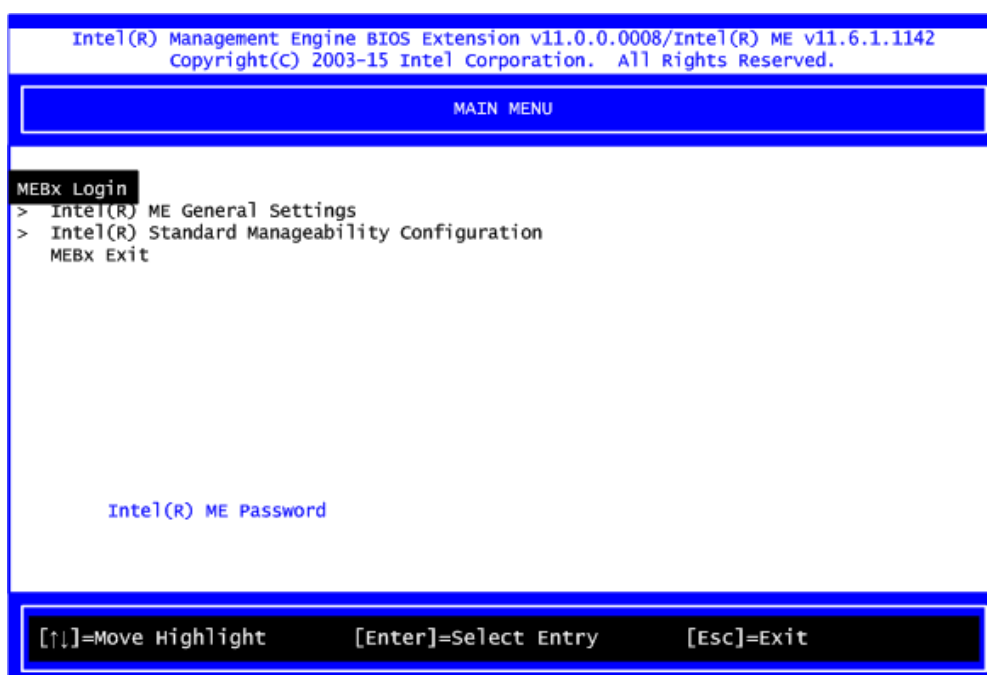

2. You will be asked to change the password before setting ME.
3. You must confirm your new password while revising. The new password must contain:  
(example: **!!11qqQQ**) (default value).
  - Eight characters
  - One upper case
  - One lower case
  - One number
  - One special symbol, such as ! \ \$ or ; \ ( \ " , excepted)

Underline ( \_ ) and space are valid characters for password, but they won't make higher complexity.

4. From Main Menu, select ME General Settings to get into ME Platform Configuration screen. In this screen you can modify Local FW Update setting.

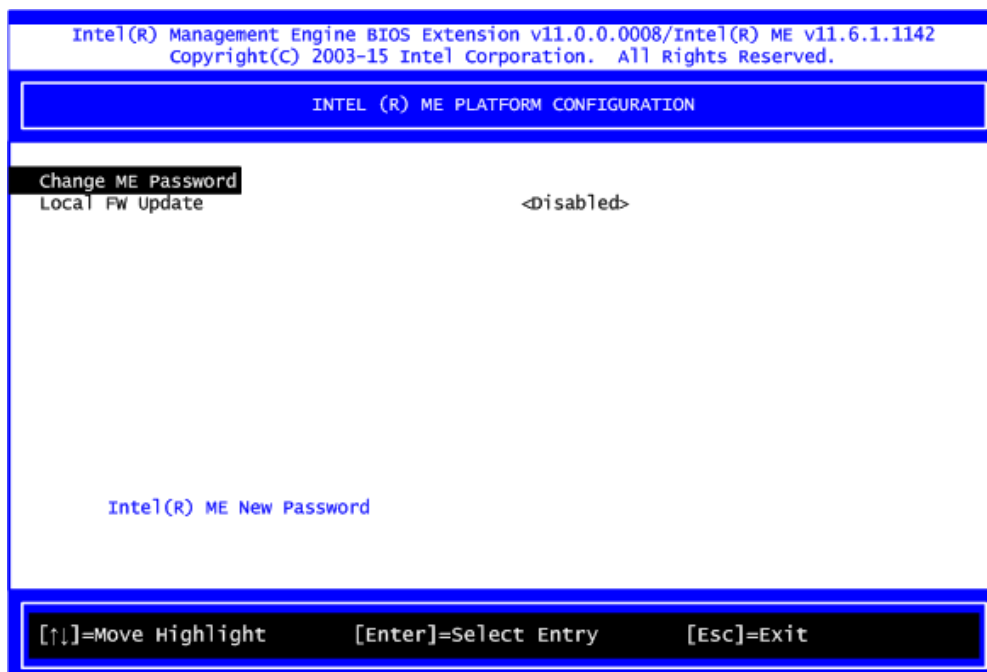

5. Return to Main Menu.

## C.3 iAMT Configuration

1. From Main Menu, select Intel® Standard Manageability Configuration and press <Enter>.
2. Set Manageability Feature Selection to Enabled.

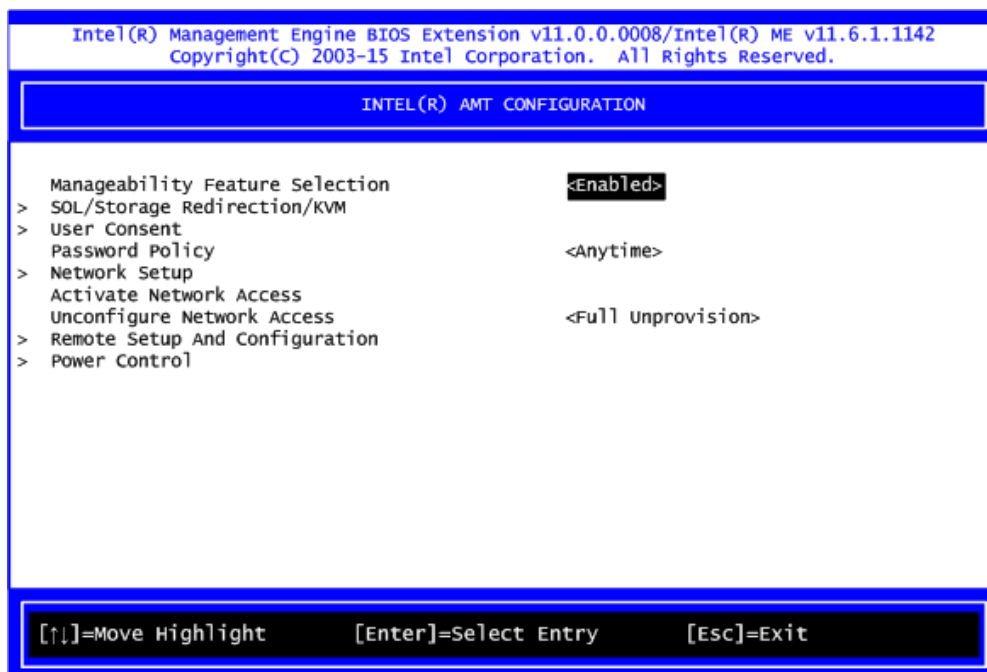

- **SOL/Storage Redirection/KVM**

This screen is for enabling or disabling Serial-over-LAN (SOL)/Storage Redirection/Keyboard Video Mouse (KVM) functionality.

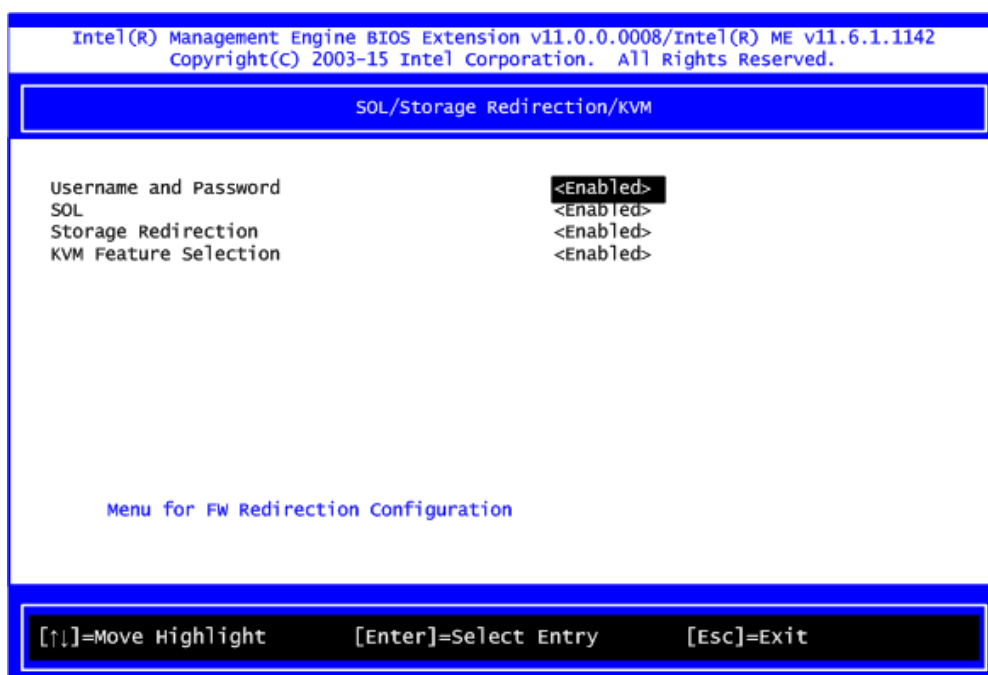

- **User Consent**

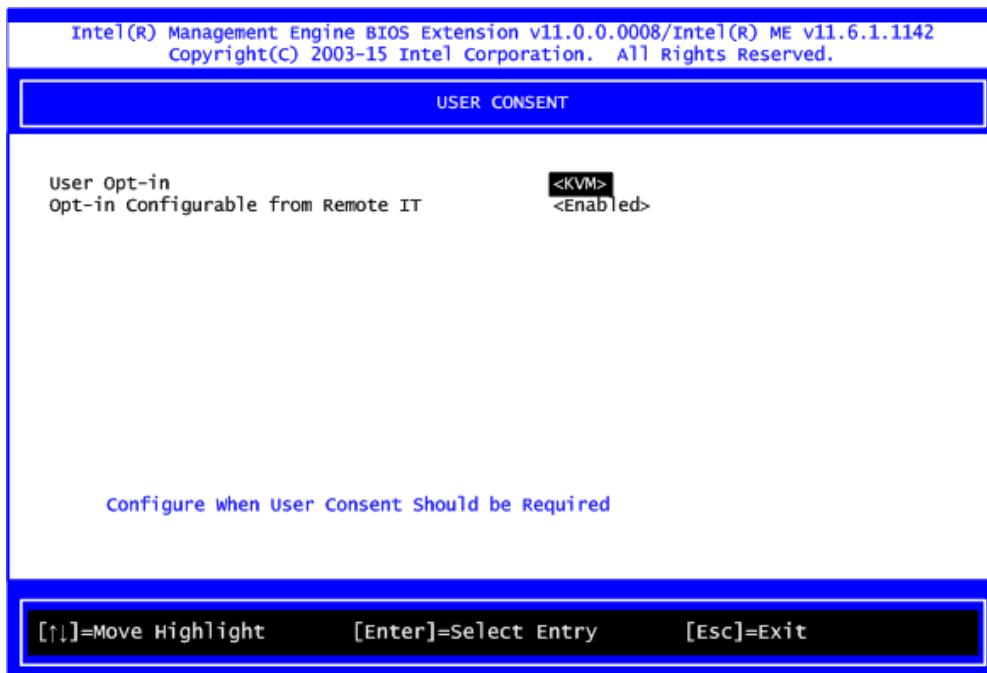

**User Opt-in**

Configure this item when user consent should be required.

**Opt-in Configurable from Remote IT**

Enable or disable remote change capability of user consent feature.

- **Network Setup**

1.From Intel® AMT Configuration Menu, select Network Setup.

2.Select ME Network Name Settings to set computer host and domain name.

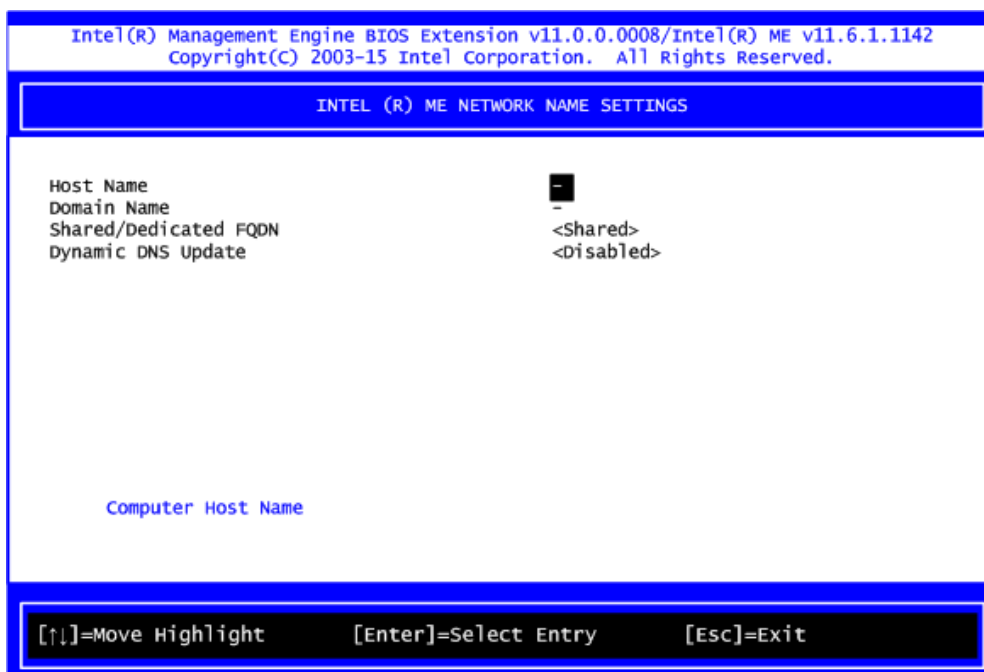
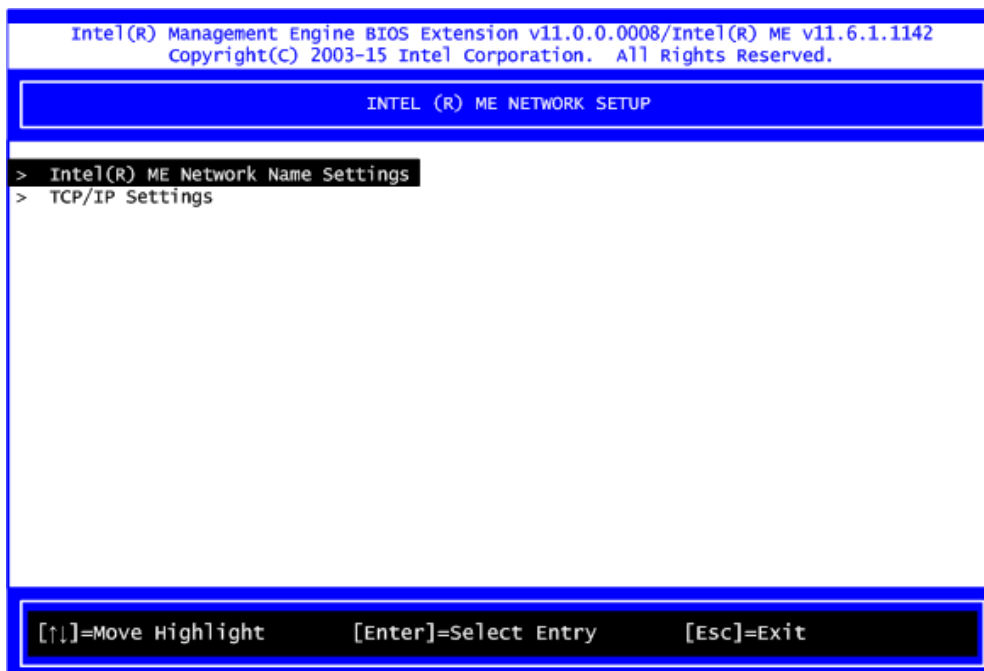

3. Select TCP/IP to get into Network interface. Get into DHCP Mode and set it to Disabled.

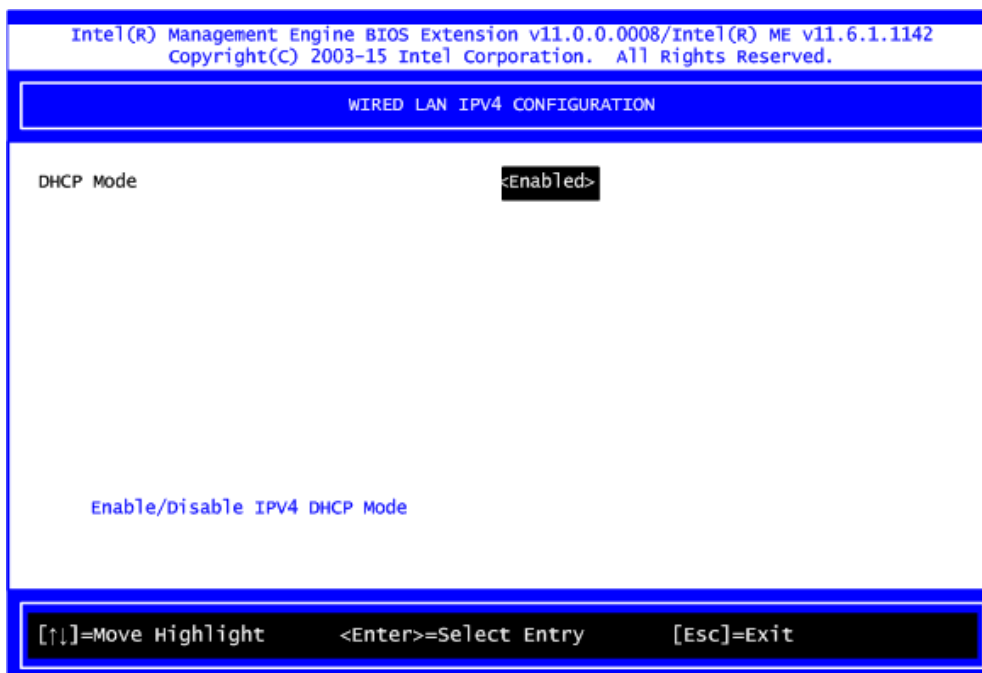
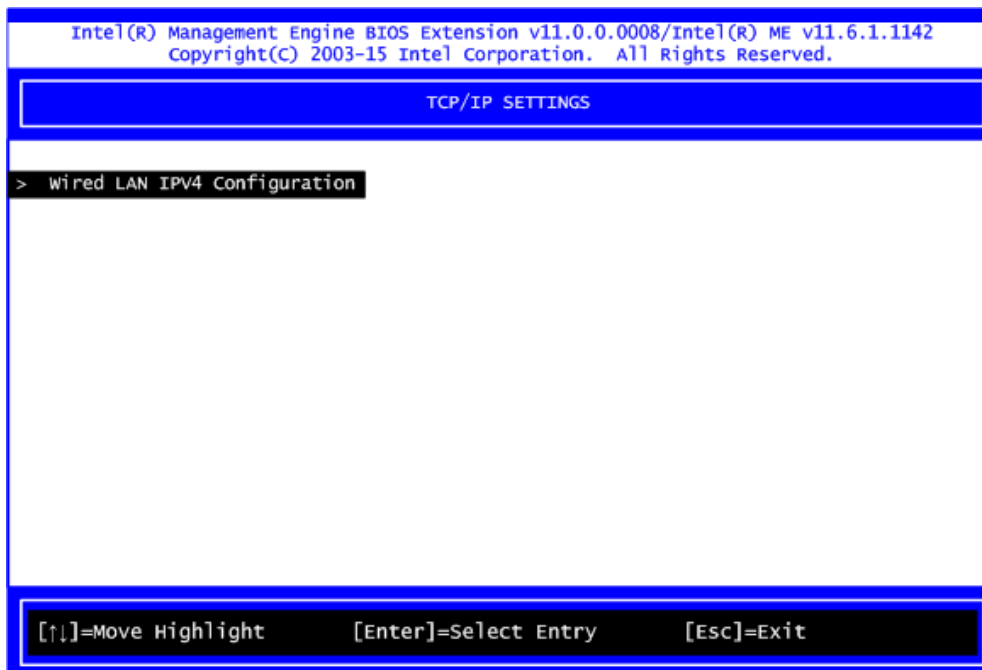

1.If DHCP Mode is disabled, set the following settings:

- IP address
- Subnet mask

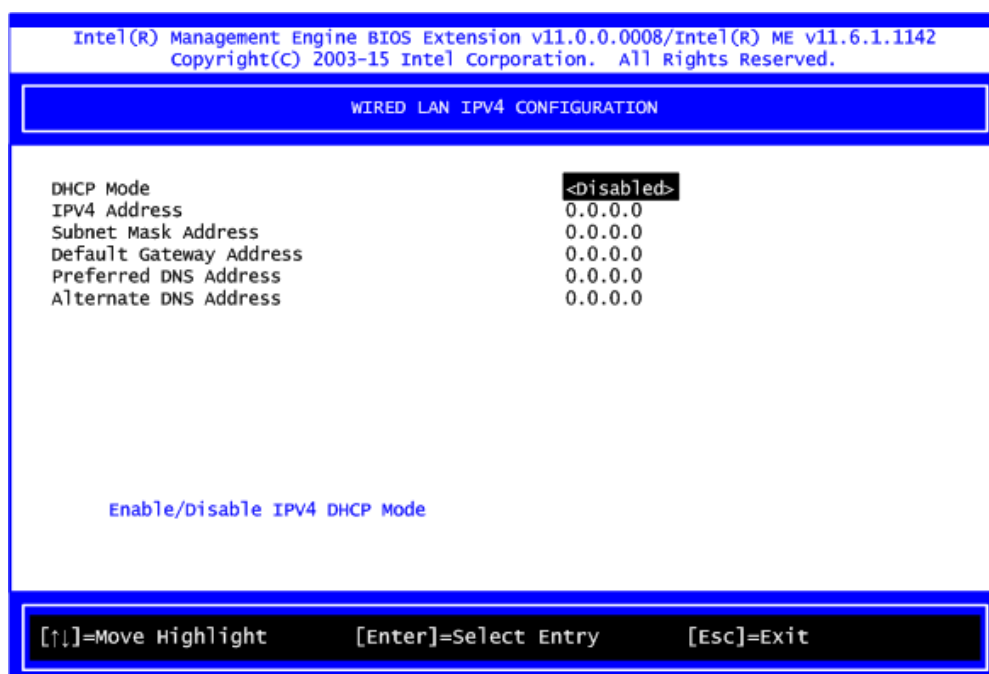

2.Go back to Intel® iAMT Configuration, then select Activate Network Access and press <Enter>.

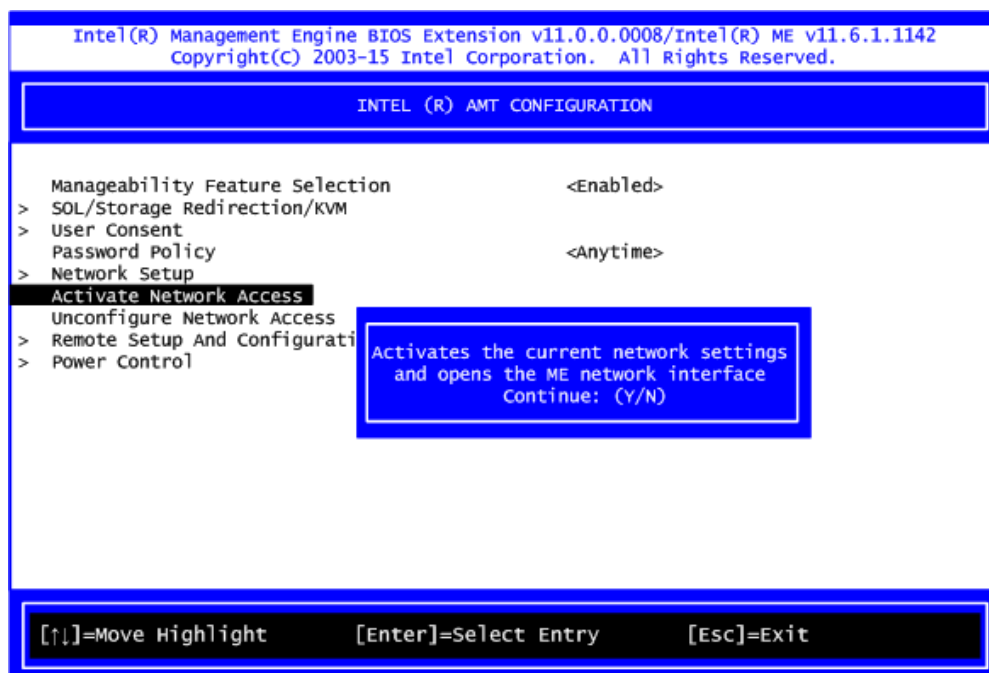

3.Exit from MEBx after completing the iAMT settings.

- Remote Setup and Configuration

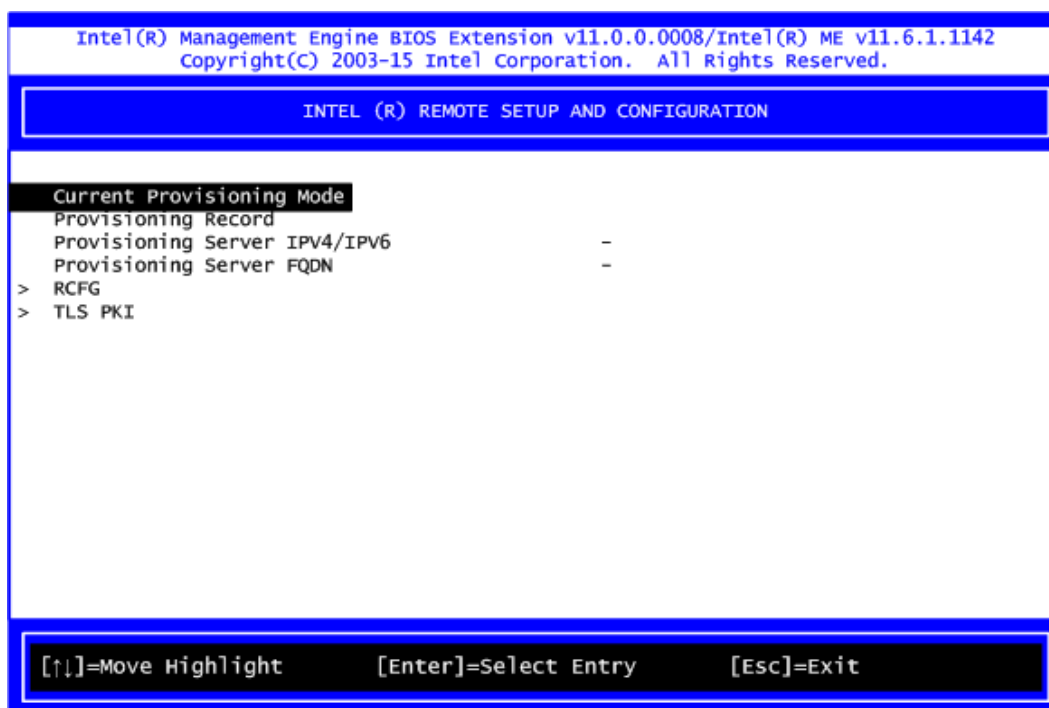

1. Select TLS PKI to get into remote configuration screen. Then select Start Configuration to activate it.

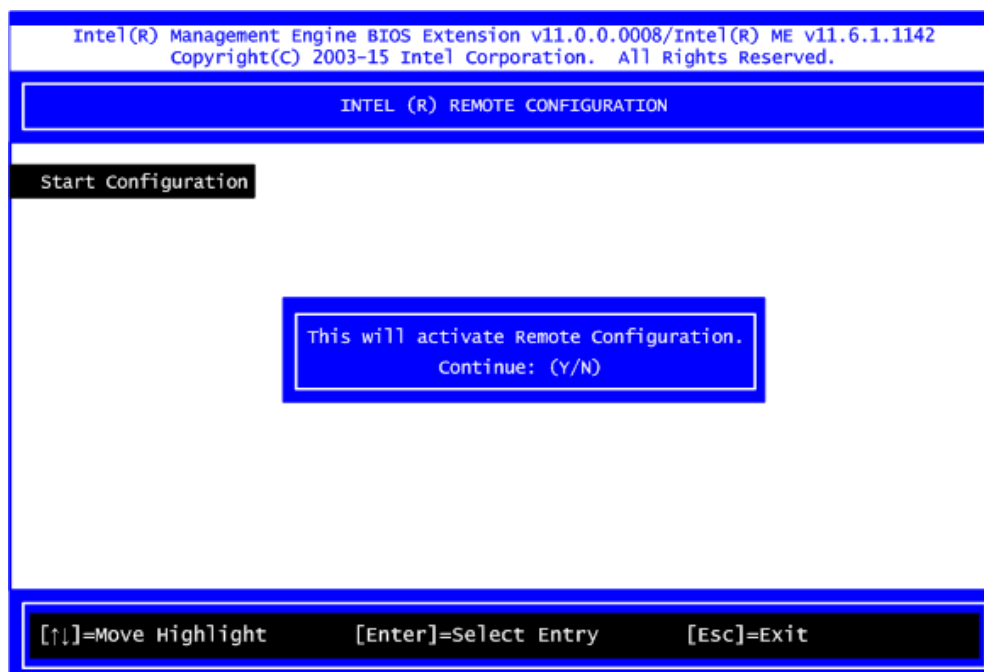



2. Select Manage Hashes to add, delete and activate hash.

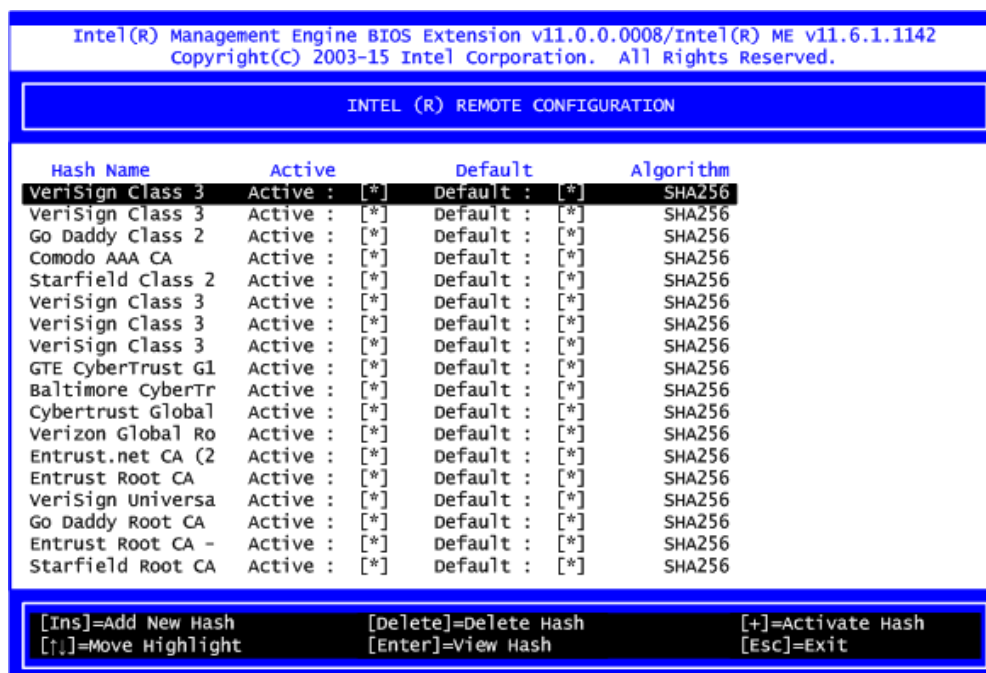
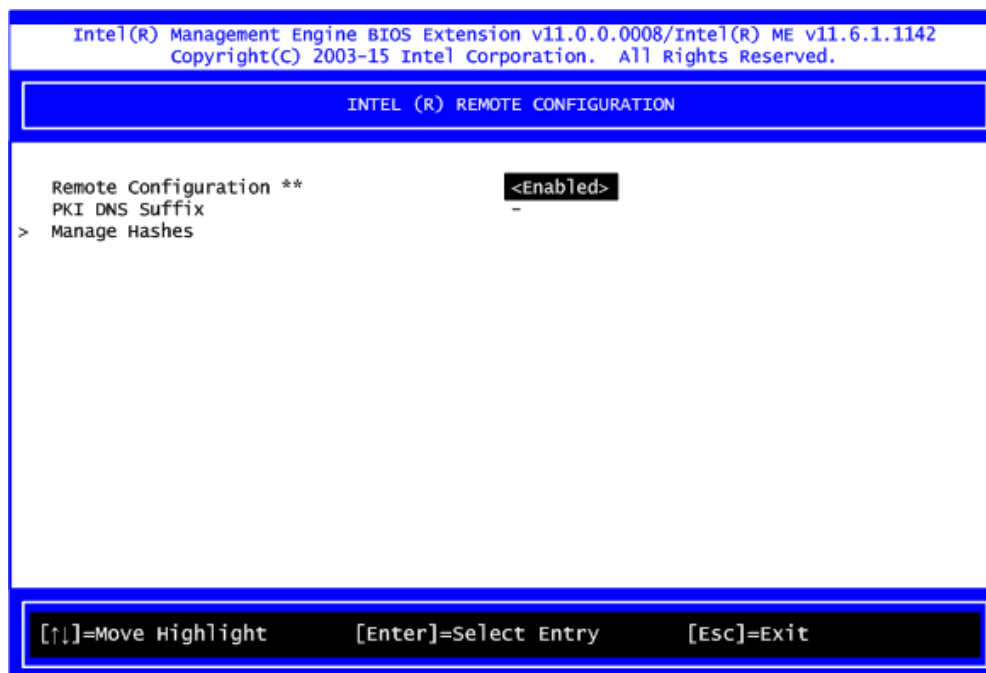

- **Power Control**

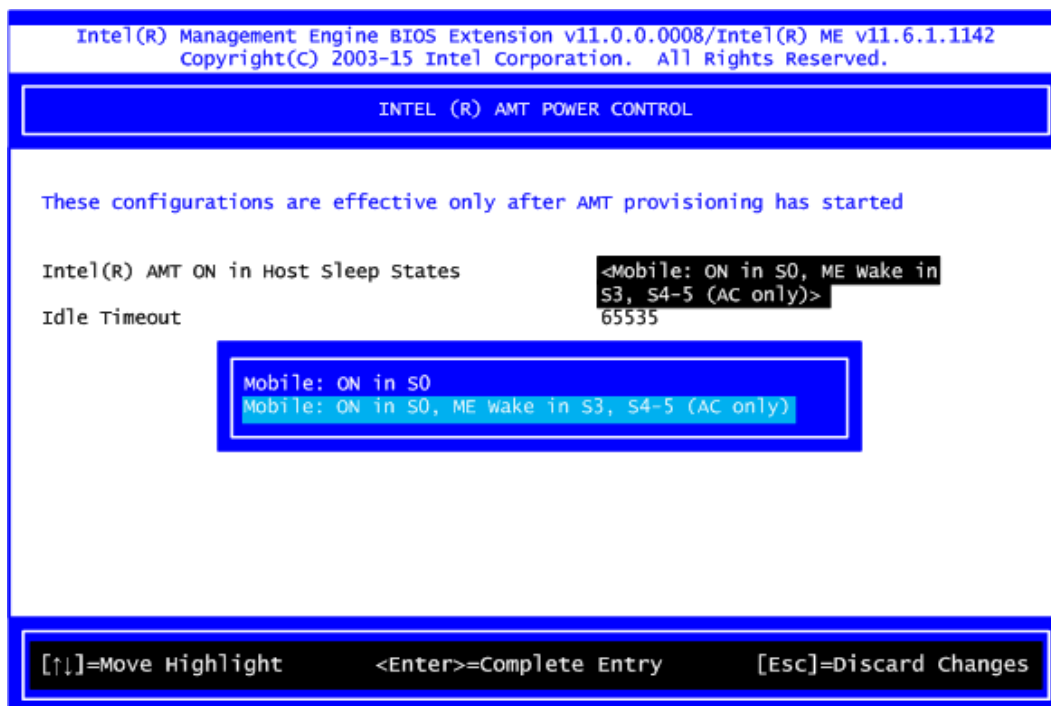

#### **AMT ON in Host Sleep States**

Select the appropriate AMT ON in Host Sleep States setting. Options are ON in S0 and ON in S0, ME Wake in S3, S4-5 (AC only).

#### **Idle Timeout**

This is timeout value for Wake\_On\_ME in minutes. It must be set to a non-zero value.

## C.4 iAMT Web Console

1. From a web browser, please type [http://\(IP ADDRESS\):16992](http://(IP ADDRESS):16992), which connects to iAMT Web.

Example: <http://10.1.40.214:16992>

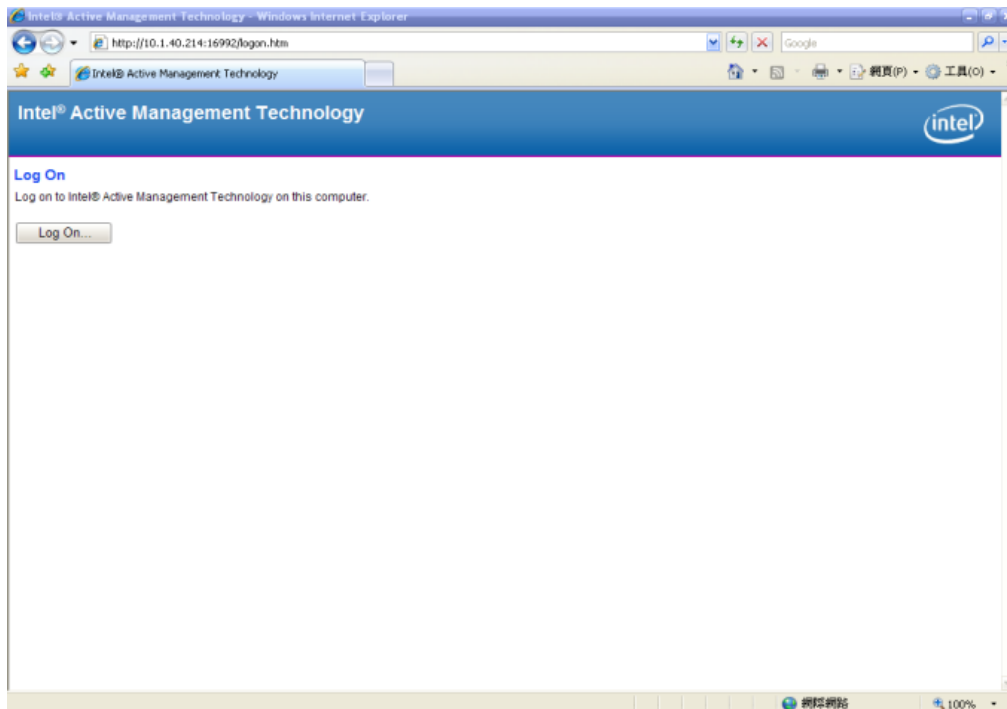

2. To log on, you will be required to type in username and password for access to the Web.

USER: admin (default value)

PASS: (MEBx password)

3. Enter the iAMT Web.

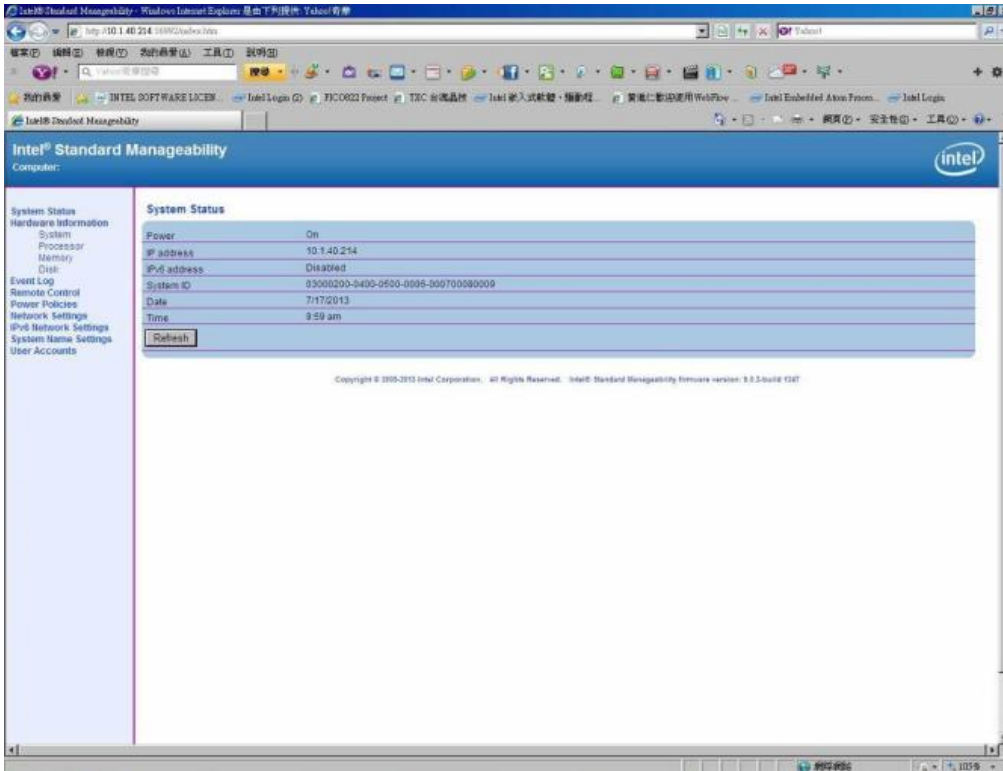

4. Click Remote Control, and select commands on the right side.

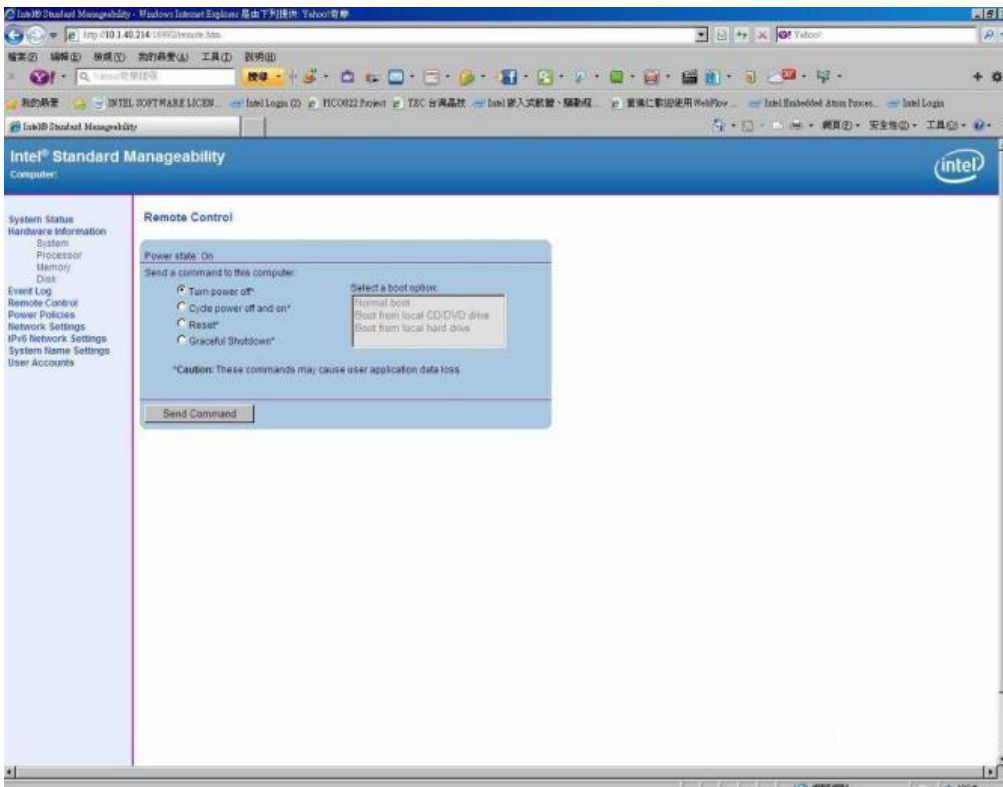

5. When you have finished using the iAMT Web console, close the Web browser.