

# USER'S MANUAL

## PICO52R

8<sup>th</sup> Generation Intel® Core™ i7/ i5/ i3  
and Celeron® Pico-ITX Board

User's Manual



[www.axiomtek.com](http://www.axiomtek.com)

## **Disclaimers**

This manual has been carefully checked and believed to contain accurate information. Axiomtek Co., Ltd. assumes no responsibility for any infringements of patents or any third party's rights, and any liability arising from such use.

Axiomtek does not warrant or assume any legal liability or responsibility for the accuracy, completeness or usefulness of any information in this document. Axiomtek does not make any commitment to update the information in this manual.

Axiomtek reserves the right to change or revise this document and/or product at any time without notice.

No part of this document may be reproduced, stored in a retrieval system, or transmitted, in any form or by any means, electronic, mechanical, photocopying, recording, or otherwise, without the prior written permission of Axiomtek Co., Ltd.

## **CAUTION**

If you replace wrong batteries, it causes the danger of explosion. It is recommended by the manufacturer that you follow the manufacturer's instructions to only replace the same or equivalent type of battery, and dispose of used ones.

**©Copyright 2023 Axiomtek Co., Ltd.**

**All Rights Reserved**

**May 2023, Version A3**

**Printed in Taiwan**

## **ESD Precautions**

Computer boards have integrated circuits sensitive to static electricity. To prevent chipsets from electrostatic discharge damage, please take care of the following jobs with precautions:

- Do not remove boards or integrated circuits from their anti-static packaging until you are ready to install them.
- Before holding the board or integrated circuit, touch an unpainted portion of the system unit chassis for a few seconds. It discharges static electricity from your body.
- Wear a wrist-grounding strap, available from most electronic component stores, when handling boards and components.

## **Trademarks Acknowledgments**

Axiomtek is a trademark of Axiomtek Co., Ltd.

Intel® and Celeron® are trademarks of Intel Corporation.

Windows® is a trademark of Microsoft Corporation.

AMI is a trademark of American Megatrend Inc.

IBM, PC/AT, PS/2, VGA are trademarks of International Business Machines Corporation.

Other brand names and trademarks are the properties and registered brands of their respective owners.

# Table of Contents

---

Disclaimers.....	ii
ESD Precautions .....	iii
<b>Section 1 Introduction.....</b>	<b>1</b>
1.1 Features .....	2
1.2 Specifications.....	2
1.3 Utilities .....	3
<b>Section 2 Board and Pin Assignments.....</b>	<b>5</b>
2.1 Board Dimensions and Fixing Holes.....	5
2.2 Board Layout.....	7
2.3 Assembly Drawing .....	9
2.4 Jumper and Switch Settings .....	11
2.4.1 LVDS +3.3V/+5V/+12V Voltage Selection (JP1).....	12
2.4.2 Restore BIOS Optimal Defaults (SW1) .....	12
2.4.3 Auto Power On (SSW1) .....	12
2.5 Connectors .....	13
2.5.1 Front Panel Connector (CN2) .....	14
2.5.2 Inverter Connector (CN3).....	14
2.5.3 LVDS Connector (CN4).....	15
2.5.4 M.2 2230 Key E Connector (CN5) .....	17
2.5.5 USB 2.0 Wafer Connector (CN6) .....	18
2.5.6 SMBus Connector (CN7) .....	18
2.5.7 Power Connector (CN8).....	18
2.5.8 USB 3.1 Port (CN9).....	19
2.5.9 DisplayPort Connector (CN10).....	19
2.5.10 HDMI Connector (CN11) .....	20
2.5.11 Digital I/O Connector (CN12) .....	20
2.5.12 Ethernet Port (LAN1).....	21
2.5.13 Ethernet Wafer Connector (LAN2) .....	21
2.5.14 SATA Port (SATA1).....	22
2.5.15 CMOS Battery Connector (BAT1) .....	22
2.5.16 COM Wafer Connectors (SCN1 and SCN2) .....	23
2.5.17 Fan Connector (SCN4) .....	24
2.5.18 SATA Power Connector (SCN5).....	24
<b>Section 3 Hardware Description .....</b>	<b>25</b>
3.1 Microprocessors .....	25

3.2	BIOS .....	25
3.3	System Memory.....	25
3.4	I/O Port Address Map.....	26
3.5	Interrupt Controller (IRQ) Map .....	27
3.6	Memory Map .....	32
<b>Section 4 AMI BIOS Setup Utility .....</b>		<b>33</b>
4.1	Starting.....	33
4.2	Navigation Keys .....	33
4.3	Main Menu.....	35
4.4	Advanced Menu.....	36
4.5	Chipset Menu.....	49
4.6	Security Menu.....	55
4.7	Boot Menu.....	56
4.8	Save & Exit Menu .....	57
<b>Appendix A Watchdog Timer.....</b>		<b>59</b>
A.1	About Watchdog Timer .....	59
A.2	How to Use Watchdog Timer.....	59
<b>Appendix B Digital I/O .....</b>		<b>61</b>
B.1	About Digital I/O .....	61
B.2	Digital I/O Programming .....	61
<b>Appendix C iAMT Settings .....</b>		<b>63</b>
C.1	Entering MEBx.....	63
C.2	Set and Change Password .....	63
C.3	iAMT Configuration.....	65
C.4	iAMT Web Console.....	73

**This page is intentionally left blank.**

# Section 1

## Introduction

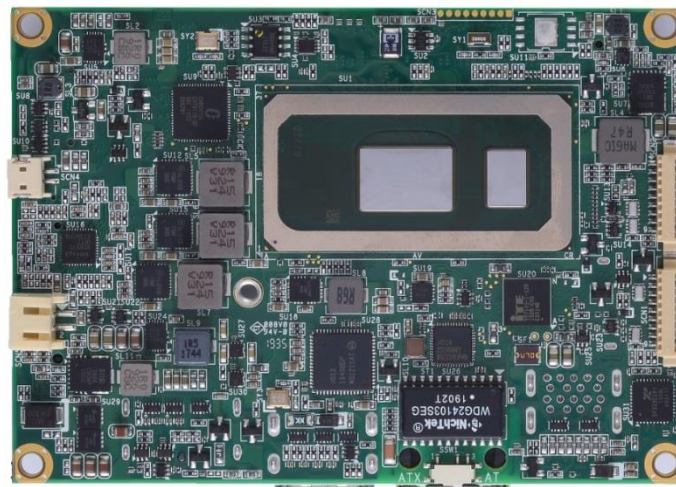
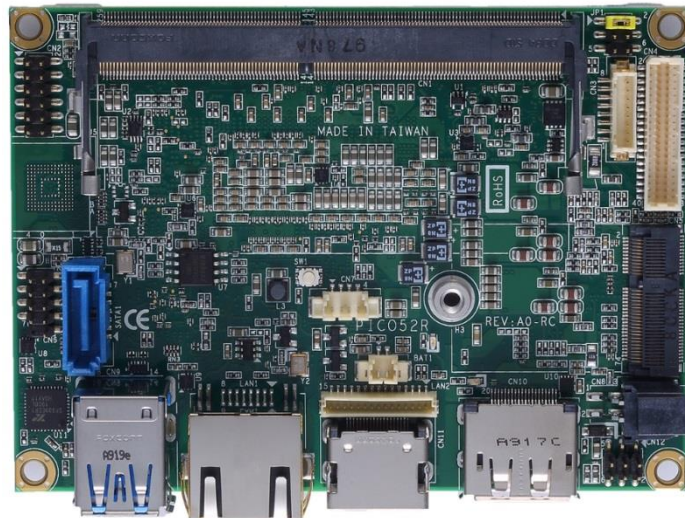

The PICO52R is a Pico-ITX board with the 8<sup>th</sup> Generation Intel® Core™ i7/ i5/ i3 and Celeron® processors that deliver outstanding system performance through high-bandwidth interfaces, multiple I/O functions for interactive applications and various embedded computing solutions.

The PICO52R has one 260-pin unbuffered SO-DIMM socket for DDR4 2400MHz SO-DIMM memory with maximum capacity up to 32GB. It also features two Gigabit/Fast Ethernet, two USB 3.1 Gen2 and two USB 2.0 high speed compliant and one M.2 Key E for wireless module. Additionally, it provides you with unique embedded features such as two serial ports which support RS-232/422/485 and 2.5" form factor that applies an extensive array of PC peripherals. The board can be enhanced by its built-in watchdog timer function, a special industrial feature not commonly seen on other motherboards.

## 1.1 Features

- PICO52R - 8<sup>th</sup> Generation Intel® Core™ i7/ i5/ i3 and Celeron® processor
- 1 DDR4 SO-DIMM supports up to 32GB memory capacity
- 2 USB 3.1 Gen2 ports and 2 USB 2.0 ports
- 2 Gigabit Ethernet ports
- LVDS/HDMI/DisplayPort
- 1 M.2 Key E

## 1.2 Specifications

- **CPU**
  - 8<sup>th</sup> Generation Intel® Core™ i7/ i5/ i3 and Celeron® processor.
- **Thermal Solution**
  - Active.
- **Operating Temperature**
  - -20°C~+60°C.
- **BIOS**
  - American Megatrends Inc. UEFI (Unified Extensible Firmware Interface) BIOS.
  - 256Mbit SPI Flash, DMI, Plug and Play.
  - PXE Ethernet Boot ROM.
- **System Memory**
  - One 260-pin unbuffered DDR4 SO-DIMM socket.
  - Maximum up to 32GB DDR4 2400MHz memory.
- **Serial Port**
  - Controller: ITE8528.
  - Two serial ports: Support RS-232/422/485.
- **Storage**
  - One SATA-600 connector.
  - 64MB eMMC (Optional).
- **USB Interface**
  - Two USB 3.1 Gen2 ports in type A on the rear I/O.
  - Two USB 2.0 ports in 2x5-pin internal wafer connector.
- **Display**
  - A standard DisplayPort connector: Support DP1.2 and DP++. The DP resolution is up to 4096x2304 @60Hz.
  - A standard HDMI connector: Support HDMI 1.4a. The HDMI resolution is up to 3840x2160 @30Hz.
  - One 2x20-pin connector for 18/24-bit single and dual channel LVDS (with one 8-pin wafer connector for inverter control). LVDS resolution is up to 1920x1200 in 24-bit dual channel.



- **Watchdog Timer**
  - 1~65536 seconds or minutes; up to 65535 levels.
- **Ethernet**
  - Two 1000/100/10Mbps Gigabit/Fast Ethernet ports.
  - LAN1: Intel® I219-LM supports 1000/100/10Mbps Gigabit/Fast Ethernet with Wake-on-LAN and PXE Boot ROM in RJ-45 connector.
  - LAN2: Intel® I210-AT supports 1000/100/10Mbps Gigabit/Fast Ethernet with Wake-on-LAN and PXE Boot ROM in 1x15-pin header.
- **Audio**
  - N/A
- **Expansion Interface**
  - One M.2 Key E connector with 22mm(width) x 30mm(length).
- **Power Input**
  - One 2x2-pin connector.
  - +12V DC-in only at minimum 12V/2A.
  - Auto power on function supported.
- **Power Management**
  - ACPI (Advanced Configuration and Power Interface).
- **Form Factor**
  - Pico-ITX form factor.



*All specifications and images are subject to change without notice.*

**Note**

## 1.3 Utilities

- Chipset and graphics driver
- Ethernet driver
- Rapid Storage Technology driver
- ME driver

**This page is intentionally left blank.**

# Section 2

## Board and Pin Assignments

### 2.1 Board Dimensions and Fixing Holes

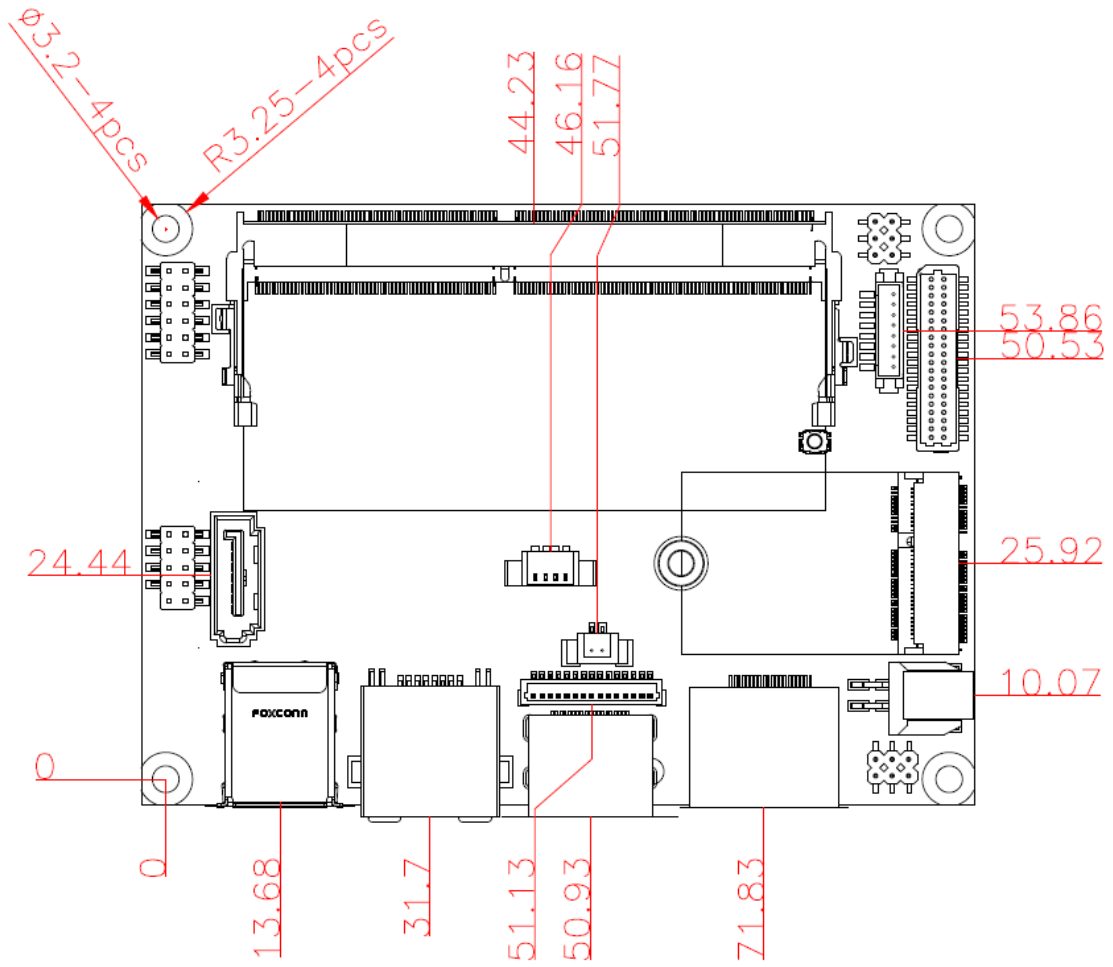

Top View

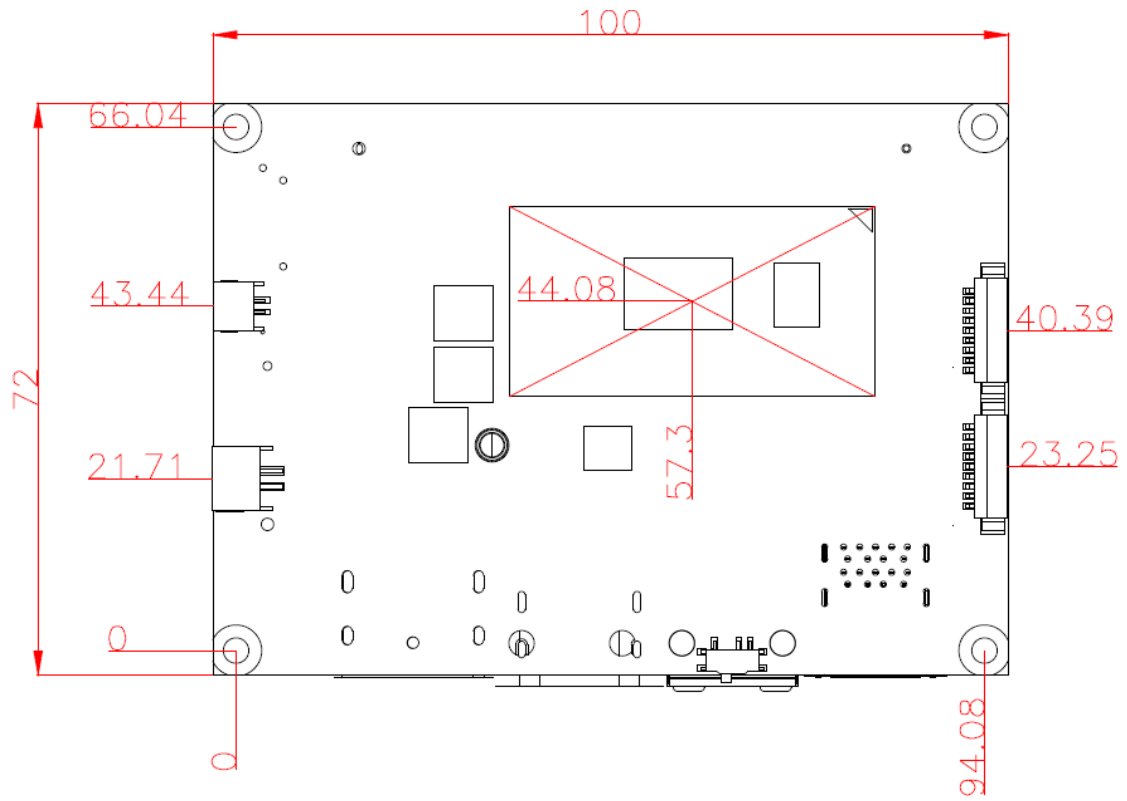

Bottom View

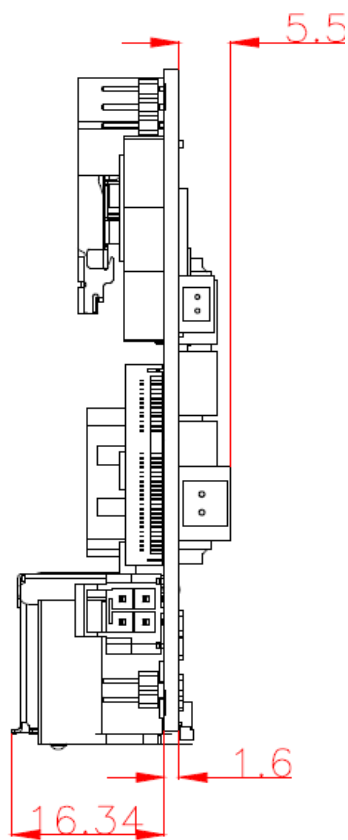

Side View

## 2.2 Board Layout

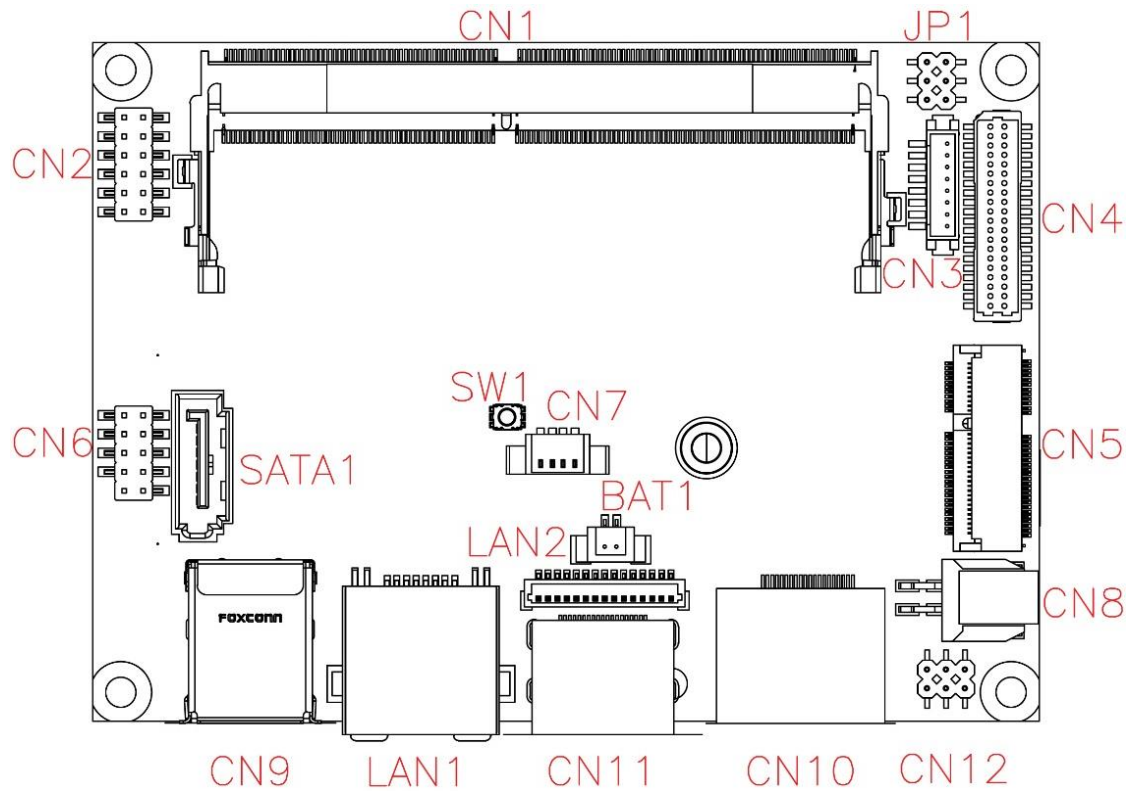

Top View

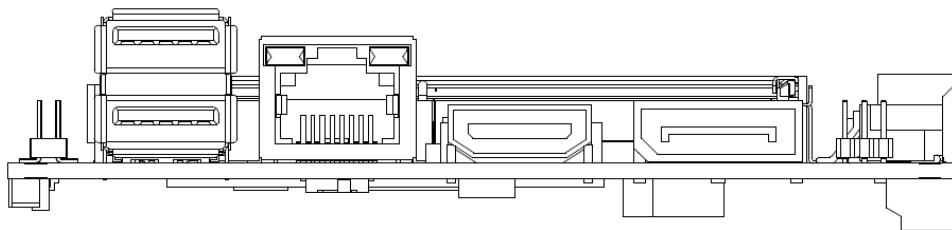

Rear I/O

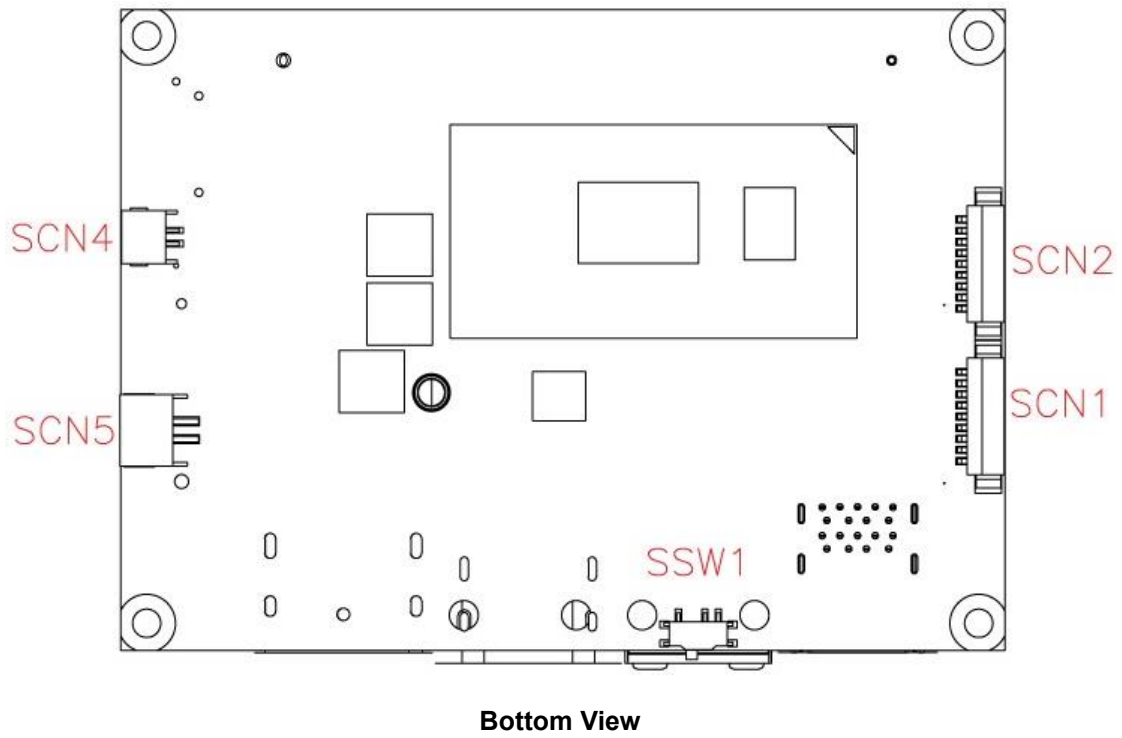

## 2.3 Assembly Drawing

For thermal dissipation, a thermal solution enables the PICO52R's components to dissipate heat efficiently. All heat generating components are thermally conducted to the heatspreader in order to avoid hot spots. Images below illustrate how to install the thermal solution on PICO52R.

1. Standard – Heatsink with fan for PICO52R (see image below):

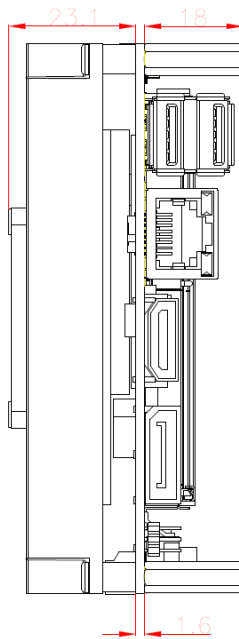
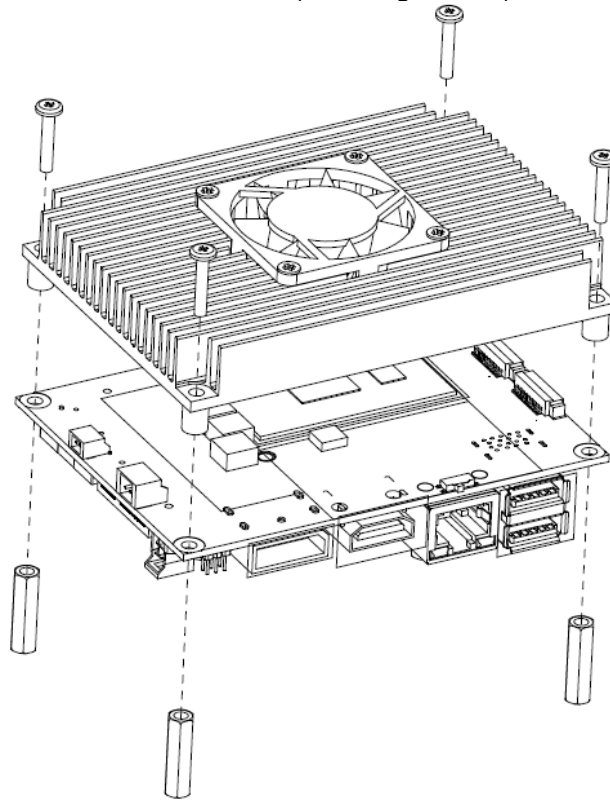

- Optional -- Heatspreader for PICO52R (see image below):

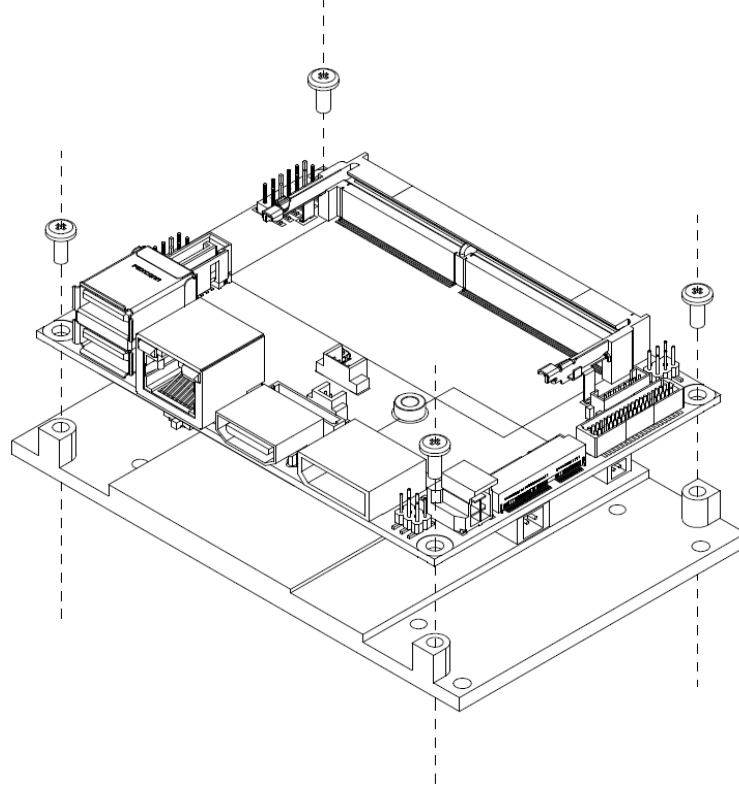

Note

***Heatspreader has a large, flat surface on top. It has no fan and no fins. Instead of cooling by forced air, it is pressed directly up against another large flat surface (for example: the frame or the inside wall of a sealed container) and heat is allowed to pass from the small heatspreader out to the larger metal surface. Heatspreader does not cool the CPU by itself, it only transfer the heat to another object where it can safely dissipate away from the processor.***

***The standard heatsink with fan cannot be screwed above heatspreader.***



## 2.4 Jumper and Switch Settings

Jumper is a small component consisting of jumper clip and jumper pins. Install jumper clip on 2 jumper pins to close. And remove jumper clip from 2 jumper pins to open. Below illustration shows how to set up jumper.

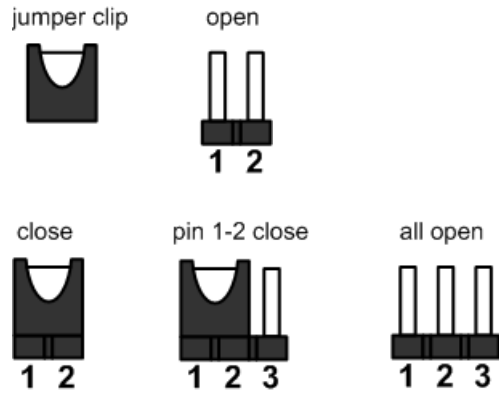

Properly configure jumper and switch settings on the PICO52R to meet your application purpose. Below you can find a summary table of jumper, switch and onboard default settings.



**Note**

*Once the default jumper or switch setting needs to be changed, please do it under power-off condition.*

Jumper and Switch	Description	Setting
JP1	LVDS +3.3V/+5V/+12V Voltage Selection Default: +3.3V Level	1-2 Close
SW1	Restore BIOS Optimal Defaults Default: Normal Operation	Release
SSW1	Auto Power On Default: Enable	2-3 Close

### 2.4.1 LVDS +3.3V/+5V/+12V Voltage Selection (JP1)

The board supports voltage selection for flat panel displays. Use these jumpers to set LVDS connector (CN4, See section 2.5.3) pin 1~6 VCCM to +3.3V, +5V or +12V. To prevent hardware damage, before connecting please make sure that the input voltage of flat panel is correct.

Function	Setting
+3.3V level (Default)	1-2 close
+5V level	2-4 close
+12V level	5-6 close

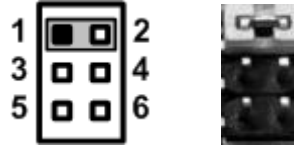

### 2.4.2 Restore BIOS Optimal Defaults (SW1)

Use SW1 to clear CMOS. Press the tact switch for at least 3 second to restore BIOS optimal defaults.

Function	Setting
Normal (Default)	Release
Restore BIOS optimal defaults	Press

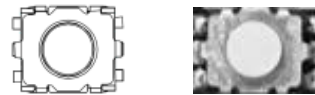

### 2.4.3 Auto Power On (SSW1)

If SSW1 is enabled for power input, the system will be automatically power on without pressing soft power button. If SSW1 is disabled for power input, it is necessary to manually press soft power button to power on the system.

Function	Setting
Disable auto power on	1-2 close
Enable auto power on (Default)	2-3 close



## 2.5 Connectors

Signals go to other parts of the system through connectors. Loose or improper connection might cause problems, please make sure all connectors are properly and firmly connected. Here is a summary table of connectors on the hardware.

Connector	Description
CN1	DDR4 SO-DIMM Connector
CN2	Front Panel Connector
CN3	Inverter Connector
CN4	LVDS Connector
CN5	M.2 2230 Key E Connector
CN6	USB 2.0 Wafer Port 3 and 4
CN7	I <sup>2</sup> C Connector
CN8	Power Connector
CN9	USB 3.1 Port
CN10	DisplayPort Connector
CN11	HDMI Connector
CN12	Digital I/O Connector
LAN1	Ethernet Port
LAN2	Ethernet Wafer Connector
SATA1	SATA Port
BAT1	CMOS Battery Connector
SCN1, SCN2	COM1 and COM2 Wafer Connectors
SCN4	Fan Connector
SCN5	SATA Power Connector

### 2.5.1 Front Panel Connector (CN2)

This is a 2x6-pin header (pitch=2.0mm) for front panel interface.

Pin	Signal	Pin	Signal
1	BUZZER-	2	BUZZER+
3	GND	4	PWR_PSON
5	PWRLED-	6	PWRLED+
7	PWRSW-	8	PWRSW+
9	HW RST-	10	HW RST+
11	HDDLED-	12	HDDLED+

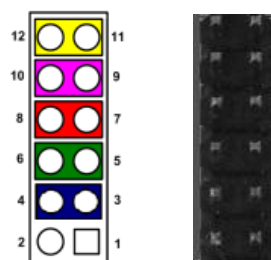

#### Internal Buzzer

Pin 1(-) and 2(+) connect the internal buzzer cable, 594H3186800E for buzzer.

#### Power Status

Pin 4 and pin 3 are for power status button; letting user know the power status of this board.

#### Power LED

Pin 6 connects anode (+) of LED and pin 5 connects cathode (-) of LED. The power LED lights up when the system is powered on.

#### Power On/Off Button

Pin 8 and 7 connect the power button on front panel to CPU board, which allows users to turn on or off power supply.

#### System Reset Switch

Pin 10 and 9 connect the case-mounted reset switch that reboots your computer without turning off the power switch. It is a better way to reboot your system for a longer life of system power supply.

#### HDD Activity LED

This connection is linked to hard drive activity LED on the control panel. LED flashes when HDD is being accessed. Pin 12 and 11 connect the hard disk drive to the front panel HDD LED, pin 11 is assigned as cathode(-) and pin 12 is assigned as anode(+).

### 2.5.2 Inverter Connector (CN3)

This is an 8-pin (pitch=1.25mm) connector which is compliant with Hirose DF13-8P-1.25V for inverter interface. We strongly recommend you to use the matching connector, DF13-8S-1.25C, to avoid malfunction.

Pin	Signal
1	+12VM1 (+12V level)
2	+12VM1 (+12V level)
3	+V5S
4	LVDS Enable Control
5	GND
6	GND
7	GND
8	LVDS Brightness Control

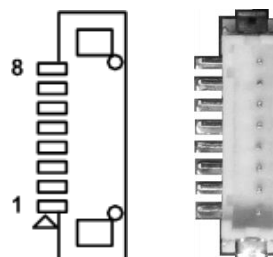

### 2.5.3 LVDS Connector (CN4)

This is a 2x20-pin (pitch=1.0mm) connector which is compliant with JST SM40B-SRDS-G-TF for LVDS LCD interface. It is strongly recommended to connect it with matching connector, SHDR-40VS-B. Pin 1~6 VCCM can be set to +3.3V, +5V or +12V by setting JP1 (see section 2.4.1).

#### 18-bit single channel

Pin	Signal	Pin	Signal
1	VCCM	2	VCCM
3	VCCM	4	VCCM
5	VCCM	6	VCCM
7	N.C	8	N.C
9	GND	10	GND
11	N.C	12	N.C
13	N.C	14	N.C
15	GND	16	GND
17	N.C	18	N.C
19	N.C	20	N.C
21	GND	22	GND
23	Channel A D0-	24	N.C
25	Channel A D0+	26	N.C
27	GND	28	GND
29	Channel A D1-	30	N.C
31	Channel A D1+	32	N.C
33	GND	34	GND
35	Channel A D2-	36	Channel A CLK-
37	Channel A D2+	38	Channel A CLK+
39	GND	40	GND

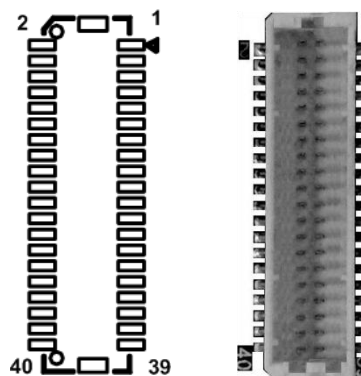

**24-bit single channel**

Pin	Signal	Pin	Signal
1	VCCM	2	VCCM
3	VCCM	4	VCCM
5	VCCM	6	VCCM
7	N.C	8	N.C
9	GND	10	GND
11	N.C	12	N.C
13	N.C	14	N.C
15	GND	16	GND
17	N.C	18	N.C
19	N.C	20	N.C
21	GND	22	GND
23	Channel A D0-	24	N.C
25	Channel A D0+	26	N.C
27	GND	28	GND
29	Channel A D1-	30	Channel A D3-
31	Channel A D1+	32	Channel A D3+
33	GND	34	GND
35	Channel A D2-	36	Channel A CLK-
37	Channel A D2+	38	Channel A CLK+
39	GND	40	GND

**18-bit dual channel**

Pin	Signal	Pin	Signal
1	VCCM	2	VCCM
3	VCCM	4	VCCM
5	VCCM	6	VCCM
7	N.C	8	N.C
9	GND	10	GND
11	N.C	12	Channel B D0-
13	N.C	14	Channel B D0+
15	GND	16	GND
17	Channel B CLK-	18	Channel B D1-
19	Channel B CLK+	20	Channel B D1+
21	GND	22	GND
23	Channel A D0-	24	Channel B D2-
25	Channel A D0+	26	Channel B D2+
27	GND	28	GND
29	Channel A D1-	30	N.C
31	Channel A D1+	32	N.C
33	GND	34	GND
35	Channel A D2-	36	Channel A CLK-
37	Channel A D2+	38	Channel A CLK+
39	GND	40	GND

**24-bit dual channel**

Pin	Signal	Pin	Signal
1	VCCM	2	VCCM
3	VCCM	4	VCCM
5	VCCM	6	VCCM
7	N.C	8	N.C
9	GND	10	GND
11	Channel B D3-	12	Channel B D0-
13	Channel B D3+	14	Channel B D0+
15	GND	16	GND
17	Channel B CLK-	18	Channel B D1-
19	Channel B CLK+	20	Channel B D1+
21	GND	22	GND
23	Channel A D0-	24	Channel B D2-
25	Channel A D0+	26	Channel B D2+
27	GND	28	GND
29	Channel A D1-	30	Channel A D3-
31	Channel A D1+	32	Channel A D3+
33	GND	34	GND
35	Channel A D2-	36	Channel A CLK-
37	Channel A D2+	38	Channel A CLK+
39	GND	40	GND

### 2.5.4 M.2 2230 Key E Connector (CN5)

The CN5 is a M.2 2230 Key E connector. It is suggested to install the M.2 wireless module via PCIe x1 with 22mm width and 30mm length.

Pin	Signal	Pin	Signal
1	GND	2	+3.3V_SBY
3	USB2_DP5	4	+3.3V_SBY
5	USB2_DN5	6	NC
7	GND	8	NC
9	NC	10	NC
11	NC	12	NC
13	NC	14	NC
15	NC	16	NC
17	NC	18	GND
19	NC	20	NC
21	NC	22	NC
23	NC	24	Key E
25	Key E	26	
27		28	
29		30	
31		32	
33	GND	34	NC
35	PCIE5_TXP	36	NC
37	PCIE5_TXN	38	NC
39	GND	40	NC
41	PCIE5_RXP	42	NC
43	PCIE5_RXN	44	NC
45	GND	46	NC
47	PCIE_CLKP5	48	NC
49	PCIE_CLKN5	50	SUSCLK (+3.3V Level)
51	GND	52	PLTRST_2_N (+3.3V Level)
53	CLKREQ#_PCIE5	54	W_DIS2# (+3.3V Level)
55	PCIE_WAKE_N	56	W_DI12# (+3.3V Level)
57	GND	58	SMBDAT_3P3_SBY
59	NC	60	SMBCLK_3P3_SBY
61	NC	62	SMBALERT#_3P3_SBY
63	GND	64	NC
65	NC	66	NC
67	NC	68	NC
69	GND	70	NC
71	NC	72	+3.3V_SBY
73	NC	74	+3.3V_SBY
75	GND		

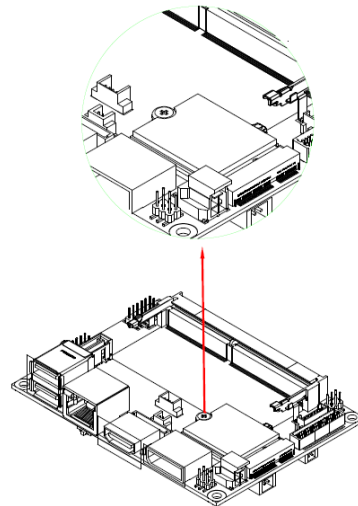
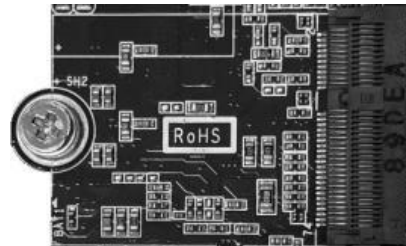
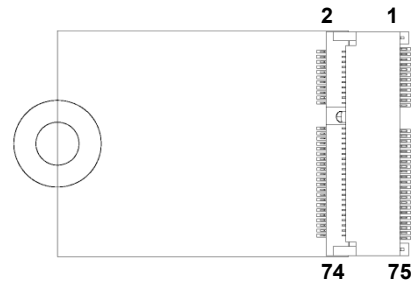

**Note**

After installing the M.2 Key E card, please screw and lock the card. It is suggested to install M.2 Key E card before DDR4 module on SO-DIMM connector (CN1).

### 2.5.5 USB 2.0 Wafer Connector (CN6)

This is a 2x5-pin cut pin 9 (pitch=2.0mm) wafer connector, which is compliant with Hirose DF11-10DP-2DSA, for installing versatile USB 2.0 compliant interface peripherals.

Pin	Signal	Pin	Signal
1	+5V_SBY	2	+5V_SBY
3	USB #3_D-	4	USB #4_D-
5	USB #3_D+	6	USB #4_D+
7	GND	8	GND
		10	GND

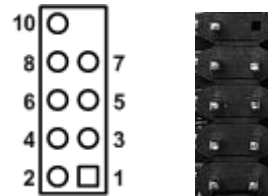

### 2.5.6 SMBus Connector (CN7)

This is a 4-pin (pitch=1.25mm) connector for SMBus interface which is compatible with I<sup>2</sup>C.

Pin	Signal
1	SMB_CLK_SBY
2	SMB_DAT_SBY
3	GPIO
4	GND



### 2.5.7 Power Connector (CN8)

This is a 2x2pin (pitch=2.5mm) connector which is compliant with Molex 1054051104.

Pin	Signal
1	GND
2	GND
3	+12V
4	+12V

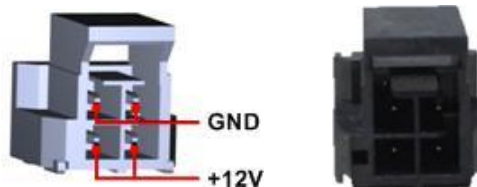



### 2.5.8 USB 3.1 Port (CN9)

The board comes with two Universal Serial Bus (compliant with USB 3.1 Gen2 (10Gb/s)) type A connectors for installing USB peripherals such as keyboard, mouse, scanner, etc.

Pin	Signal	Pin	Signal
1	+5V	10	+5V
2	USB_Data1-	11	USB_Data2-
3	USB_Data1+	12	USB_Data2+
4	GND	13	GND
5	SSRX1-	14	SSRX2-
6	SSRX1+	15	SSRX2+
7	GND	16	GND
8	SSTX1-	17	SSTX2-
9	SSTX1+	18	SSTX2+

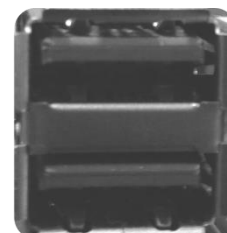
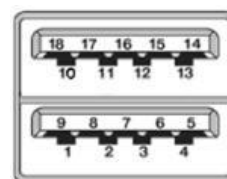

### 2.5.9 DisplayPort Connector (CN10)

The DisplayPort interface is available through connector CN10.

Pin	Signal
1	DPB_LANE0
2	GND
3	DPB_LANE0#
4	DPB_LANE1
5	GND
6	DPB_LANE1#
7	DPB_LANE2
8	GND
9	DPB_LANE2#
10	DPB_LANE3
11	GND
12	DPB_LANE3#
13	Detect Pin
14	GND
15	DPB_AUX
16	GND
17	DPB_AUX#
18	DPB_HPD
19	GND
20	+3.3V

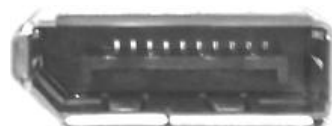
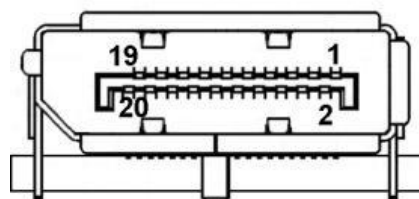

### 2.5.10 HDMI Connector (CN11)

The HDMI (High-Definition Multimedia Interface) is a compact digital interface which is capable of transmitting high-definition video and high-resolution audio over a single cable. Its interface is available through connector CN11.

Pin	Signal	Pin	Signal
1	HDMI OUT_DATA2+	2	GND
3	HDMI OUT_DATA2-	4	HDMI OUT_DATA1+
5	GND	6	HDMI OUT_DATA1-
7	HDMI OUT_DATA0+	8	GND
9	HDMI OUT_DATA0-	10	HDMI OUT_Clock+
11	GND	12	HDMI OUT_Clock-
13	N.C.	14	N.C.
15	HDMI OUT_SCL	16	HDMI OUT_SDA
17	GND	18	+5V
19	HDMI_HTPLG		

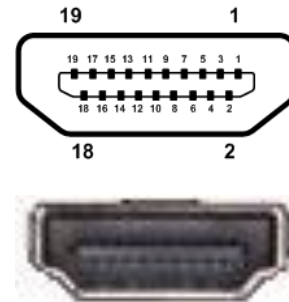

### 2.5.11 Digital I/O Connector (CN12)

This is a 2x3-pin (pitch=2.0mm) connector. The board is equipped with a 4-bit digital I/O that meets requirements for a system customary automation control. The digital I/O can be configured to control cash drawers and sense warning signals from an Uninterrupted Power System (UPS), or perform store security control. You may use software programming to control these digital signals, please refer to Appendix B.

Pin	Signal	Pin	Signal
1	DIO 0	2	DIO 3
3	DIO 1	4	DIO 2
5	+5V	6	GND

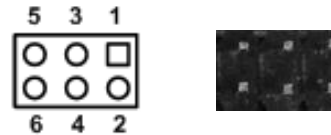

### 2.5.12 Ethernet Port (LAN1)

The board has one RJ-45 Ethernet connector for LAN1 with Intel® gigabit Ethernet controller i219. Ethernet connection can be established by plugging one end of the Ethernet cable into this connector and the other end (phone jack) to a 1000/100/10-Base-T hub.

Pin	1000 Base-T	100/10 Base-T	Description
L1	BI_DA+	TX+	Bidirectional or Transmit Data+
L2	BI_DA-	TX-	Bidirectional or Transmit Data-
L3	BI_DB+	RX+	Bidirectional or Receive Data+
L4	BI_DC+	N.C.	Bidirectional or Not Connected
L5	BI_DC-	N.C.	Bidirectional or Not Connected
L6	BI_DB-	RX-	Bidirectional or Receive Data-
L7	BI_DD+	N.C.	Bidirectional or Not Connected
L8	BI_DD-	N.C.	Bidirectional or Not Connected
A	Active Link LED (Yellow) Off: No link Blinking: Data activity detected		
B	Speed LED 1000: Orange 100/10: Green/OFF		

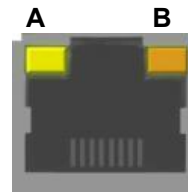
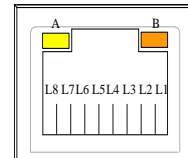

### 2.5.13 Ethernet Wafer Connector (LAN2)

This is a 15-pin (pitch=1.0mm) wafer connector which is compliant with JST BM15B-SRSS-TB for Ethernet port interface.

Pin	Signal
1	GND
2	LAN_LINK_ACT
3	LAN_VDD33
4	GND
5	MDI0+
6	MDI0-
7	MDI1+
8	MDI2+
9	MDI2-
10	MDI1-
11	MDI3+
12	MDI3-
13	GND
14	LAN_100_LED-
15	LAN_1000_LED-

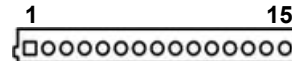

### 2.5.14 SATA Port (SATA1)

The Serial Advanced Technology Attachment (Serial ATA or SATA) connector is computer bus interface for connecting to devices such as hard disk drive.

Pin	Signal
1	GND
2	SATA_TX+
3	SATA_TX-
4	GND
5	SATA_RX-
6	SATA_RX+
7	GND

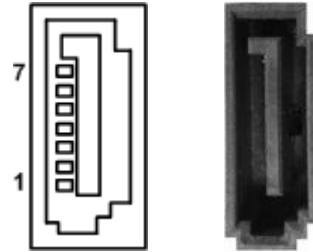

### 2.5.15 CMOS Battery Connector (BAT1)

This is a 2-pin (pitch=1.25mm) wafer connector for CMOS battery interface.

Pin	Signal
1	BAT1(+3V level)
2	GND



### 2.5.16 COM Wafer Connectors (SCN1 and SCN2)

This is a 9-pin (pitch=1.25mm) connector which is compliant with Molex 53047-0910. Both SCN1 (for COM1) and SCN2 (for COM2) support RS-232/422/485 by BIOS selected (see section 4.4). The pin assignments of RS-232/422/485 are listed in table below. It is strongly recommended to connect with the matching cable, 59380880250E.

#### COM1:

Pin	RS-232	RS-422	RS-485
1	GND	GND	GND
2	RI1	No use	No use
3	DTR1	RX1-	No use
4	CTS1	No use	No use
5	TX1	RX1+	No use
6	RTS1	No use	No use
7	RX1	TX1+	Data+
8	DSR1	No use	No use
9	DCD1	TX1-	Data-

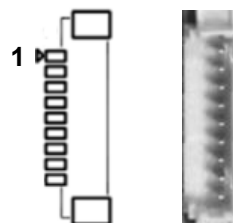

#### COM2:

Pin	RS-232	RS-422	RS-485
1	GND	GND	GND
2	RI2	No use	No use
3	DTR2	RX2-	No use
4	CTS2	No use	No use
5	TX2	RX2+	No use
6	RTS2	No use	No use
7	RX2	TX2+	Data+
8	DSR2	No use	No use
9	DCD2	TX2-	Data-

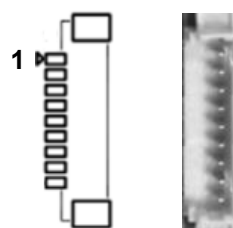

### 2.5.17 Fan Connector (SCN4)

This is a 2-pin (pitch=1.5mm) wafer connector for 12V/0.5A fan interface.

Pin	Signal
1	+V12S
2	GND



### 2.5.18 SATA Power Connector (SCN5)

This is a 2-pin (pitch=2.0mm) wafer connector for 5V/1A DC power output.

Pin	Signal
1	+V5S
2	GND

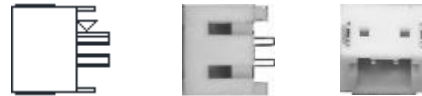

# Section 3

## Hardware Description

### 3.1 Microprocessors

The PICO52R supports 8<sup>th</sup> Generation Intel® Core™ i7/ i5/ i3 and Celeron® processors which enable your system to operate under Windows® 10 environments. The system performance depends on the microprocessor. Make sure all correct settings are arranged for your installed microprocessor to prevent the CPU from damages.



















































### 3.2 BIOS

The PICO52R uses AMI Plug and Play BIOS with a single 256Mbit SPI Flash.

### 3.3 System Memory

The PICO52R supports one 260-pin DDR4 SO-DIMM socket for maximum memory capacity up to 32GB DDR4 SDRAMs. The memory module comes in sizes of 4GB, 8GB, 16GB and 32GB.







































































































### 3.4 I/O Port Address Map

▼		Input/output (IO)
		[0000000000000000 - 000000000000CF7] PCI Express Root Complex
		[0000000000000020 - 0000000000000021] Programmable interrupt controller
		[0000000000000024 - 0000000000000025] Programmable interrupt controller
		[0000000000000028 - 0000000000000029] Programmable interrupt controller
		[000000000000002C - 000000000000002D] Programmable interrupt controller
		[000000000000002E - 000000000000002F] Motherboard resources
		[0000000000000030 - 0000000000000031] Programmable interrupt controller
		[0000000000000034 - 0000000000000035] Programmable interrupt controller
		[0000000000000038 - 0000000000000039] Programmable interrupt controller
		[000000000000003C - 000000000000003D] Programmable interrupt controller
		[0000000000000040 - 0000000000000043] System timer
		[000000000000004E - 000000000000004F] Motherboard resources
		[0000000000000050 - 0000000000000053] System timer
		[0000000000000060 - 0000000000000060] Standard PS/2 Keyboard
		[0000000000000061 - 0000000000000061] Motherboard resources
		[0000000000000062 - 0000000000000062] Microsoft ACPI-Compliant Embedded Controller
		[0000000000000063 - 0000000000000063] Motherboard resources
		[0000000000000064 - 0000000000000064] Standard PS/2 Keyboard
		[0000000000000065 - 0000000000000065] Motherboard resources
		[0000000000000066 - 0000000000000066] Microsoft ACPI-Compliant Embedded Controller
		[0000000000000067 - 0000000000000067] Motherboard resources
		[0000000000000070 - 0000000000000070] Motherboard resources
		[0000000000000080 - 0000000000000080] Motherboard resources
		[0000000000000092 - 0000000000000092] Motherboard resources
		[00000000000000A0 - 00000000000000A1] Programmable interrupt controller
		[00000000000000A4 - 00000000000000A5] Programmable interrupt controller
		[00000000000000A8 - 00000000000000A9] Programmable interrupt controller
		[00000000000000AC - 00000000000000AD] Programmable interrupt controller
		[00000000000000B0 - 00000000000000B1] Programmable interrupt controller
		[00000000000000B2 - 00000000000000B3] Motherboard resources
		[00000000000000B4 - 00000000000000B5] Programmable interrupt controller
		[00000000000000B8 - 00000000000000B9] Programmable interrupt controller
		[00000000000000BC - 00000000000000BD] Programmable interrupt controller
		[0000000000002F8 - 0000000000002FF] Communications Port (COM2)
		[0000000000003F8 - 0000000000003FF] Communications Port (COM1)
		[0000000000004D0 - 0000000000004D1] Programmable interrupt controller
		[000000000000680 - 00000000000069F] Motherboard resources
		[000000000000D00 - 000000000000FFFF] PCI Express Root Complex
		[000000000000164E - 000000000000164F] Motherboard resources
		[0000000000001800 - 00000000000018FE] Motherboard resources
		[0000000000001854 - 0000000000001857] Motherboard resources
		[0000000000002000 - 00000000000020FE] Motherboard resources
		[0000000000003000 - 0000000000003FFF] Intel(R) PCI Express Root Port #9 - 9DB0
		[0000000000004000 - 000000000000403F] Intel(R) UHD Graphics 610
		[0000000000004000 - 000000000000403F] Intel(R) UHD Graphics 620
		[0000000000004060 - 000000000000407F] Intel(R) 300 Series Chipset Family SATA AHCI Controller
		[0000000000004080 - 0000000000004083] Intel(R) 300 Series Chipset Family SATA AHCI Controller
		[0000000000004090 - 0000000000004097] Intel(R) 300 Series Chipset Family SATA AHCI Controller
		[000000000000EFA0 - 000000000000EFBF] Intel(R) SMBus - 9DA3



### 3.5 Interrupt Controller (IRQ) Map

The interrupt controller (IRQ) mapping list is shown as follows:

 (ISA) 0x00000000 (00)	System timer	 (ISA) 0x00000065 (101)	Microsoft ACPI-Compliant System
 (ISA) 0x00000001 (01)	Standard PS/2 Keyboard	 (ISA) 0x00000066 (102)	Microsoft ACPI-Compliant System
 (ISA) 0x00000003 (03)	Communications Port (COM2)	 (ISA) 0x00000067 (103)	Microsoft ACPI-Compliant System
 (ISA) 0x00000004 (04)	Communications Port (COM1)	 (ISA) 0x00000068 (104)	Microsoft ACPI-Compliant System
 (ISA) 0x0000000E (14)	Intel(R) Serial IO GPIO Host Controller - INT34BB	 (ISA) 0x00000069 (105)	Microsoft ACPI-Compliant System
 (ISA) 0x00000037 (55)	Microsoft ACPI-Compliant System	 (ISA) 0x0000006A (106)	Microsoft ACPI-Compliant System
 (ISA) 0x00000038 (56)	Microsoft ACPI-Compliant System	 (ISA) 0x0000006B (107)	Microsoft ACPI-Compliant System
 (ISA) 0x00000039 (57)	Microsoft ACPI-Compliant System	 (ISA) 0x0000006C (108)	Microsoft ACPI-Compliant System
 (ISA) 0x0000003A (58)	Microsoft ACPI-Compliant System	 (ISA) 0x0000006D (109)	Microsoft ACPI-Compliant System
 (ISA) 0x0000003B (59)	Microsoft ACPI-Compliant System	 (ISA) 0x0000006E (110)	Microsoft ACPI-Compliant System
 (ISA) 0x0000003C (60)	Microsoft ACPI-Compliant System	 (ISA) 0x0000006F (111)	Microsoft ACPI-Compliant System
 (ISA) 0x0000003D (61)	Microsoft ACPI-Compliant System	 (ISA) 0x00000070 (112)	Microsoft ACPI-Compliant System
 (ISA) 0x0000003E (62)	Microsoft ACPI-Compliant System	 (ISA) 0x00000071 (113)	Microsoft ACPI-Compliant System
 (ISA) 0x0000003F (63)	Microsoft ACPI-Compliant System	 (ISA) 0x00000072 (114)	Microsoft ACPI-Compliant System
 (ISA) 0x00000040 (64)	Microsoft ACPI-Compliant System	 (ISA) 0x00000073 (115)	Microsoft ACPI-Compliant System
 (ISA) 0x00000041 (65)	Microsoft ACPI-Compliant System	 (ISA) 0x00000074 (116)	Microsoft ACPI-Compliant System
 (ISA) 0x00000042 (66)	Microsoft ACPI-Compliant System	 (ISA) 0x00000075 (117)	Microsoft ACPI-Compliant System
 (ISA) 0x00000043 (67)	Microsoft ACPI-Compliant System	 (ISA) 0x00000076 (118)	Microsoft ACPI-Compliant System
 (ISA) 0x00000044 (68)	Microsoft ACPI-Compliant System	 (ISA) 0x00000077 (119)	Microsoft ACPI-Compliant System
 (ISA) 0x00000045 (69)	Microsoft ACPI-Compliant System	 (ISA) 0x00000078 (120)	Microsoft ACPI-Compliant System
 (ISA) 0x00000046 (70)	Microsoft ACPI-Compliant System	 (ISA) 0x00000079 (121)	Microsoft ACPI-Compliant System
 (ISA) 0x00000047 (71)	Microsoft ACPI-Compliant System	 (ISA) 0x0000007A (122)	Microsoft ACPI-Compliant System
 (ISA) 0x00000048 (72)	Microsoft ACPI-Compliant System	 (ISA) 0x0000007B (123)	Microsoft ACPI-Compliant System
 (ISA) 0x00000049 (73)	Microsoft ACPI-Compliant System	 (ISA) 0x0000007C (124)	Microsoft ACPI-Compliant System
 (ISA) 0x0000004A (74)	Microsoft ACPI-Compliant System	 (ISA) 0x0000007D (125)	Microsoft ACPI-Compliant System
 (ISA) 0x0000004B (75)	Microsoft ACPI-Compliant System	 (ISA) 0x0000007E (126)	Microsoft ACPI-Compliant System
 (ISA) 0x0000004C (76)	Microsoft ACPI-Compliant System	 (ISA) 0x0000007F (127)	Microsoft ACPI-Compliant System
 (ISA) 0x0000004D (77)	Microsoft ACPI-Compliant System	 (ISA) 0x00000080 (128)	Microsoft ACPI-Compliant System
 (ISA) 0x0000004E (78)	Microsoft ACPI-Compliant System	 (ISA) 0x00000081 (129)	Microsoft ACPI-Compliant System
 (ISA) 0x0000004F (79)	Microsoft ACPI-Compliant System	 (ISA) 0x00000082 (130)	Microsoft ACPI-Compliant System
 (ISA) 0x00000050 (80)	Microsoft ACPI-Compliant System	 (ISA) 0x00000083 (131)	Microsoft ACPI-Compliant System
 (ISA) 0x00000051 (81)	Microsoft ACPI-Compliant System	 (ISA) 0x00000084 (132)	Microsoft ACPI-Compliant System
 (ISA) 0x00000052 (82)	Microsoft ACPI-Compliant System	 (ISA) 0x00000085 (133)	Microsoft ACPI-Compliant System
 (ISA) 0x00000053 (83)	Microsoft ACPI-Compliant System	 (ISA) 0x00000086 (134)	Microsoft ACPI-Compliant System
 (ISA) 0x00000054 (84)	Microsoft ACPI-Compliant System	 (ISA) 0x00000087 (135)	Microsoft ACPI-Compliant System
 (ISA) 0x00000055 (85)	Microsoft ACPI-Compliant System	 (ISA) 0x00000088 (136)	Microsoft ACPI-Compliant System
 (ISA) 0x00000056 (86)	Microsoft ACPI-Compliant System	 (ISA) 0x00000089 (137)	Microsoft ACPI-Compliant System
 (ISA) 0x00000057 (87)	Microsoft ACPI-Compliant System	 (ISA) 0x0000008A (138)	Microsoft ACPI-Compliant System
 (ISA) 0x00000058 (88)	Microsoft ACPI-Compliant System	 (ISA) 0x0000008B (139)	Microsoft ACPI-Compliant System
 (ISA) 0x00000059 (89)	Microsoft ACPI-Compliant System	 (ISA) 0x0000008C (140)	Microsoft ACPI-Compliant System
 (ISA) 0x0000005A (90)	Microsoft ACPI-Compliant System	 (ISA) 0x0000008D (141)	Microsoft ACPI-Compliant System
 (ISA) 0x0000005B (91)	Microsoft ACPI-Compliant System	 (ISA) 0x0000008E (142)	Microsoft ACPI-Compliant System
 (ISA) 0x0000005C (92)	Microsoft ACPI-Compliant System	 (ISA) 0x0000008F (143)	Microsoft ACPI-Compliant System
 (ISA) 0x0000005D (93)	Microsoft ACPI-Compliant System	 (ISA) 0x00000090 (144)	Microsoft ACPI-Compliant System
 (ISA) 0x0000005E (94)	Microsoft ACPI-Compliant System	 (ISA) 0x00000091 (145)	Microsoft ACPI-Compliant System
 (ISA) 0x0000005F (95)	Microsoft ACPI-Compliant System	 (ISA) 0x00000092 (146)	Microsoft ACPI-Compliant System
 (ISA) 0x00000060 (96)	Microsoft ACPI-Compliant System	 (ISA) 0x00000093 (147)	Microsoft ACPI-Compliant System
 (ISA) 0x00000061 (97)	Microsoft ACPI-Compliant System	 (ISA) 0x00000094 (148)	Microsoft ACPI-Compliant System
 (ISA) 0x00000062 (98)	Microsoft ACPI-Compliant System	 (ISA) 0x00000095 (149)	Microsoft ACPI-Compliant System
 (ISA) 0x00000063 (99)	Microsoft ACPI-Compliant System	 (ISA) 0x00000096 (150)	Microsoft ACPI-Compliant System
 (ISA) 0x00000064 (100)	Microsoft ACPI-Compliant System	 (ISA) 0x00000097 (151)	Microsoft ACPI-Compliant System
		 (ISA) 0x00000098 (152)	Microsoft ACPI-Compliant System























-  (PCI) 0xFFFFFFFF5 (-11) Intel(R) Management Engine Interface
-  (PCI) 0xFFFFFFFF6 (-10) Intel(R) I211 Gigabit Network Connection
-  (PCI) 0xFFFFFFFF7 (-9) Intel(R) I211 Gigabit Network Connection
-  (PCI) 0xFFFFFFFF8 (-8) Intel(R) I211 Gigabit Network Connection
-  (PCI) 0xFFFFFFFF9 (-7) Intel(R) I211 Gigabit Network Connection
-  (PCI) 0xFFFFFFFFFA (-6) Intel(R) USB 3.1 eXtensible Host Controller - 1.10 (Microsoft)
-  (PCI) 0xFFFFFFFFFB (-5) Intel(R) UHD Graphics 610
-  (PCI) 0xFFFFFFFFFC (-4) Intel(R) Ethernet Connection (6) I219-LM
-  (PCI) 0xFFFFFFFFFD (-3) Intel(R) 300 Series Chipset Family SATA AHCI Controller
-  (PCI) 0xFFFFFFFFFE (-2) Intel(R) PCI Express Root Port #9 - 9DB0



### 3.6 Memory Map

The memory mapping list is shown as follows:

- Memory
  - [0000000000A0000 - 0000000000BFFFF] PCI Express Root Complex
  - [0000000000E0000 - 0000000000E3FFF] PCI Express Root Complex
  - [0000000000E4000 - 0000000000E7FFF] PCI Express Root Complex
  - [0000000000E8000 - 0000000000EBFFF] PCI Express Root Complex
  - [0000000000EC000 - 0000000000EFFFF] PCI Express Root Complex
  - [0000000000F0000 - 0000000000FFFFFF] PCI Express Root Complex
  - [000000004000000 - 00000000403FFFF] Motherboard resources
  - [000000009000000 - 000000009FFFFFF] Intel(R) UHD Graphics 610
  - [000000009000000 - 000000009FFFFFF] Intel(R) UHD Graphics 620
  - [000000009000000 - 00000000DFFFFFF] PCI Express Root Complex
  - [00000000A000000 - 00000000A0FFFFFF] Intel(R) UHD Graphics 610
  - [00000000A000000 - 00000000A0FFFFFF] Intel(R) UHD Graphics 620
  - [00000000A110000 - 00000000A11FFFF] Intel(R) PCI Express Root Port #9 - 9DB0
  - [00000000A11DC00 - 00000000A11DFFF] Intel(R) I211 Gigabit Network Connection
  - [00000000A11E000 - 00000000A11FFFF] Intel(R) I211 Gigabit Network Connection
  - [00000000A120000 - 00000000A121FFF] Intel(R) Ethernet Connection (6) I219-LM
  - [00000000A122000 - 00000000A122FFF] Intel(R) USB 3.1 eXtensible Host Controller - 1.10 (Microsoft)
  - [00000000A123C00 - 00000000A123DFF] Intel(R) 300 Series Chipset Family SATA AHCI Controller
  - [00000000A124000 - 00000000A1240FF] Intel(R) SMBus - 9DA3
  - [00000000A124100 - 00000000A1241FF] Intel SD Host Controller
  - [00000000A124200 - 00000000A12427F] Intel(R) 300 Series Chipset Family SATA AHCI Controller
  - [00000000A124300 - 00000000A12430F] Intel(R) 300 Series Chipset Family SATA AHCI Controller
  - [00000000A124500 - 00000000A1245FF] Intel SD Host Controller
  - [00000000E000000 - 00000000EFFFFFF] Motherboard resources
  - [00000000FC80000 - 00000000FE7FFFF] PCI Express Root Complex
  - [00000000FD00000 - 00000000FD69FFF] Motherboard resources
  - [00000000FD6A000 - 00000000FD6AFFF] Intel(R) Serial IO GPIO Host Controller - INT34BB
  - [00000000FD6B000 - 00000000FD6CFFF] Motherboard resources
  - [00000000FD6D000 - 00000000FD6DFFF] Intel(R) Serial IO GPIO Host Controller - INT34BB
  - [00000000FD6E000 - 00000000FD6EFFF] Intel(R) Serial IO GPIO Host Controller - INT34BB
  - [00000000FD6F000 - 00000000FD6FFFF] Motherboard resources
  - [00000000FE00000 - 00000000FE01FFF] Motherboard resources
  - [00000000FE01000 - 00000000FE010FF] Intel(R) SPI (flash) Controller - 9DA4
  - [00000000FE0FB00 - 00000000FE0FBFF] Intel(R) Management Engine Interface
  - [00000000FE0FC00 - 00000000FE0FFFF] High Definition Audio Controller
  - [00000000FE10000 - 00000000FE1FFFF] High Definition Audio Controller
  - [00000000FE20000 - 00000000FE7FFFF] Motherboard resources
  - [00000000FED0000 - 00000000FED003FF] High precision event timer
  - [00000000FED1000 - 00000000FED17FFF] Motherboard resources
  - [00000000FED1800 - 00000000FED18FFF] Motherboard resources
  - [00000000FED1900 - 00000000FED19FFF] Motherboard resources
  - [00000000FED2000 - 00000000FED3FFFF] Motherboard resources
  - [00000000FED4500 - 00000000FED8FFFF] Motherboard resources
  - [00000000FED9000 - 00000000FED93FFF] Motherboard resources
  - [00000000FEE0000 - 00000000FEEFFFF] Motherboard resources
  - [00000000FF00000 - 00000000FFFFFFF] Motherboard resources

---

# Section 4

## AMI BIOS Setup Utility

The AMI UEFI BIOS provides users with a built-in setup program to modify basic system configuration. All configured parameters are stored in a flash chip to save the setup information whenever the power is turned off. This section provides users with detailed description about how to set up basic system configuration through the AMI BIOS setup utility.

### 4.1 Starting

To enter the setup screens, follow the steps below:

1. Turn on the computer and press the <Del> key immediately.
2. After you press the <Del> key, the main BIOS setup menu displays. You can access the other setup screens from the main BIOS setup menu, such as the Advanced and Chipset menus.



**Note**

*If your computer cannot boot after making and saving system changes with BIOS setup, you can restore BIOS optimal defaults by setting SW1 (see section 2.4.2).*

It is strongly recommended that you should avoid changing the chipset's defaults. Both AMI and your system manufacturer have carefully set up these defaults that provide the best performance and reliability.

### 4.2 Navigation Keys

The BIOS setup/utility uses a key-based navigation system called hot keys. Most of the BIOS setup utility hot keys can be used at any time during the setup navigation process. These keys include <F1>, <F2>, <Enter>, <ESC>, <Arrow> keys, and so on.



**Note**

*Some of the navigation keys differ from one screen to another.*

Hot Keys	Description
<b>→← Left/Right</b>	The Left and Right <Arrow> keys allow you to select a setup screen.
<b>↑↓ Up/Down</b>	The Up and Down <Arrow> keys allow you to select a setup screen or sub-screen.
<b>+– Plus/Minus</b>	The Plus and Minus <Arrow> keys allow you to change the field value of a particular setup item.
<b>Tab</b>	The <Tab> key allows you to select setup fields.
<b>F1</b>	The <F1> key allows you to display the General Help screen.
<b>F2</b>	The <F2> key allows you to Load Previous Values.
<b>F3</b>	The <F3> key allows you to Load Optimized Defaults.
<b>F4</b>	The <F4> key allows you to save any changes you have made and exit Setup. Press the <F4> key to save your changes.
<b>Esc</b>	The <Esc> key allows you to discard any changes you have made and exit the Setup. Press the <Esc> key to exit the setup without saving your changes.
<b>Enter</b>	The <Enter> key allows you to display or change the setup option listed for a particular setup item. The <Enter> key can also allow you to display the setup sub- screens.



## 4.3 Main Menu

When you first enter the setup utility, you will enter the Main setup screen. You can always return to the Main setup screen by selecting the Main tab. System Time/Date can be set up as described below. The Main BIOS setup screen is shown below.

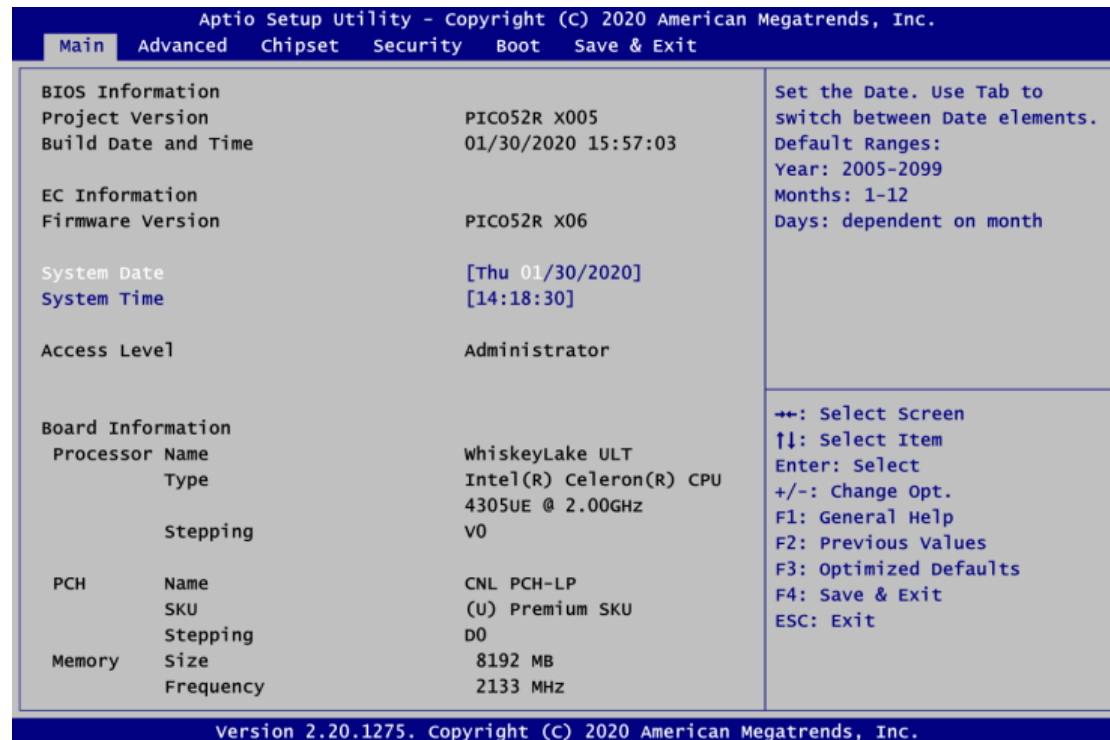

- BIOS and EC Information**  
 Display BIOS and EC firmware information.
- System Date/Time**  
 Use this option to change the system time and date. Highlight System Time or System Date using the <Arrow> keys. Enter new values through the keyboard. Press the <Tab> key or the <Arrow> keys to move between fields. The date must be entered in MM/DD/YY format. The time is entered in HH:MM:SS format.
- Access Level**  
 Display the access level of current user.
- Board Information**  
 Display the board information.

## 4.4 Advanced Menu

The Advanced menu also allows users to set configuration of the CPU and other system devices. You can select any of the items in the left frame of the screen to go to the sub menus:

- ▶ EC DIO Configuration
- ▶ Serial Port Configuration
- ▶ Hardware Monitor
- ▶ ACPI Settings
- ▶ CPU Configuration
- ▶ SATA Configuration
- ▶ PCH-FW Configuration
- ▶ AMT Configuration
- ▶ USB Configuration

For items marked with “▶”, please press <Enter> for more options.

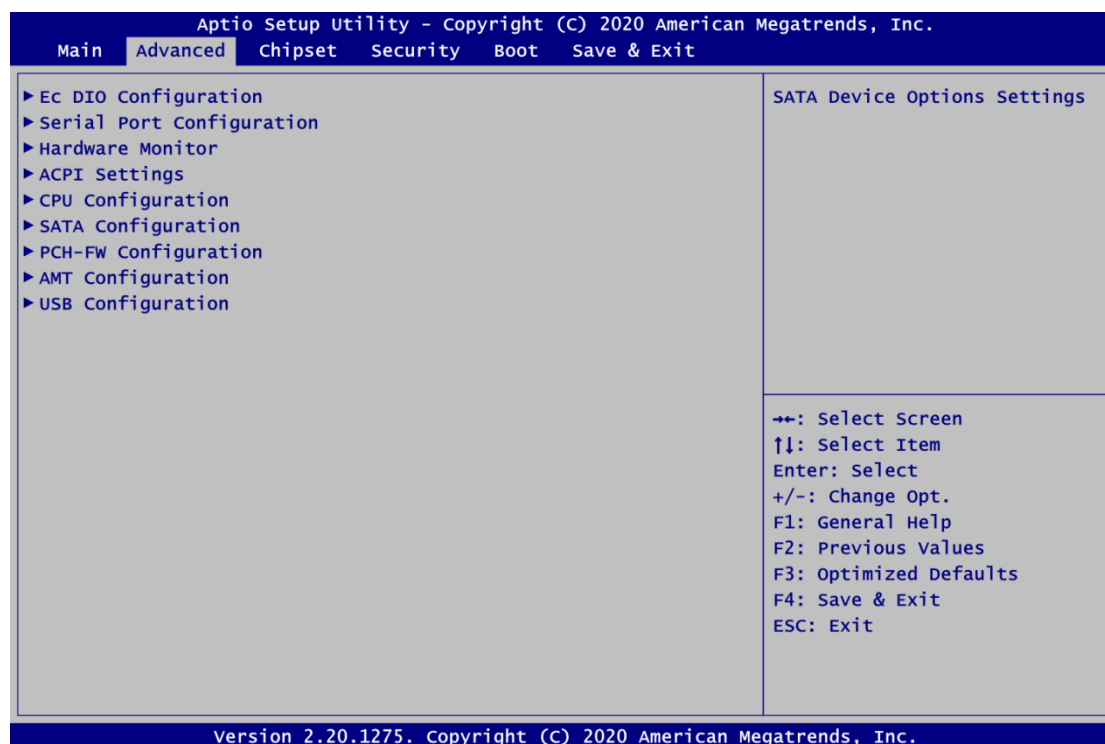

- **EC DIO Configuration**

You can use this screen to select options for the 4-bit Digital I/O Configuration. A description of selected item appears on the right side of the screen. For items marked with “▶”, please press <Enter> for more options.

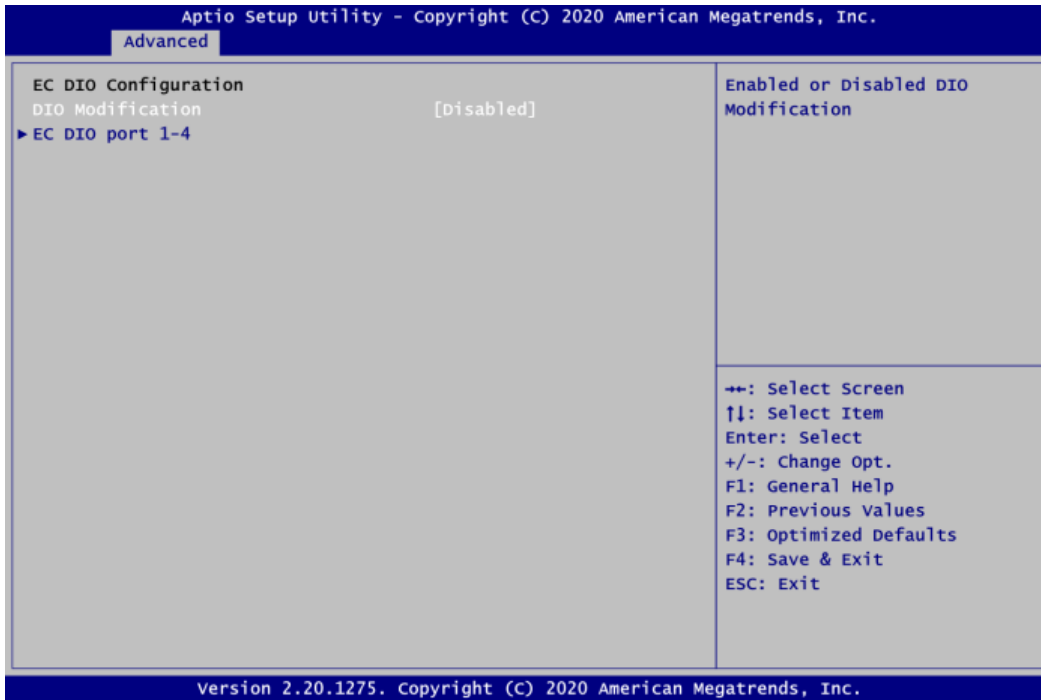

**DIO Modification**

Enable or disable digital I/O modification. The default is Disabled.

**EC DIO port 1-4**

Use this item to set parameters of DIO1~4, and change the DIO type of the selected option.

If DIO Modification is disabled, you are not allowed to change inputs/outputs setting. The DIO status sub screen is as follows:

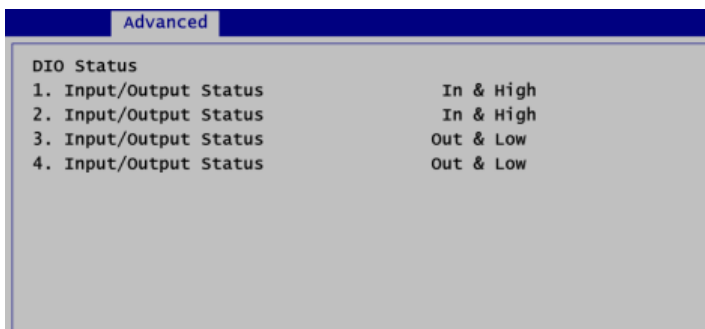

If DIO Modification is enabled, you can load manufacture default and access to the DIO status sub screen to change inputs/outputs setting, see images below.

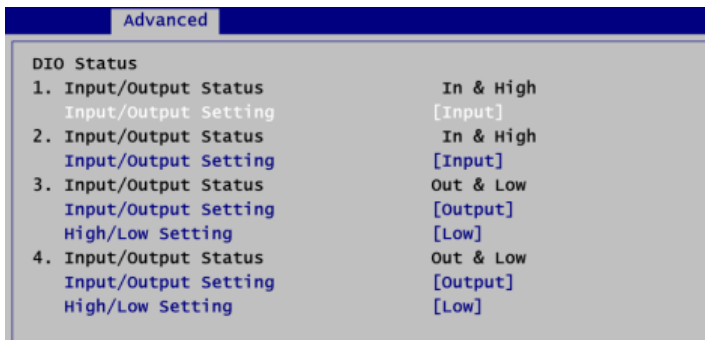
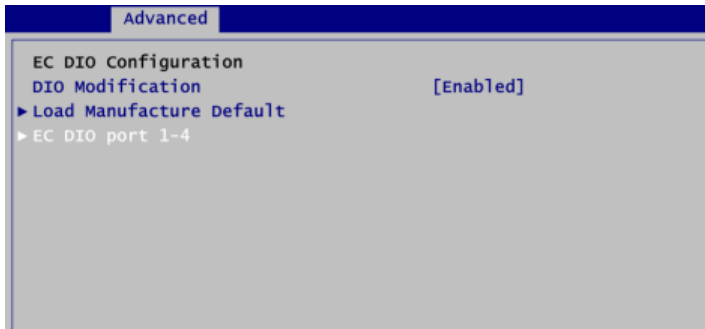

- **Serial Port Configuration**

You can use this screen to select options for the Serial Port Configuration, and change the value of the selected option. A description of the selected item appears on the right side of the screen. For items marked with “▶”, please press <Enter> for more options.



### Serial Port 1~2 Configuration

Use these items to set parameters related to serial port 1~2.

- **Serial Port 1 Configuration**

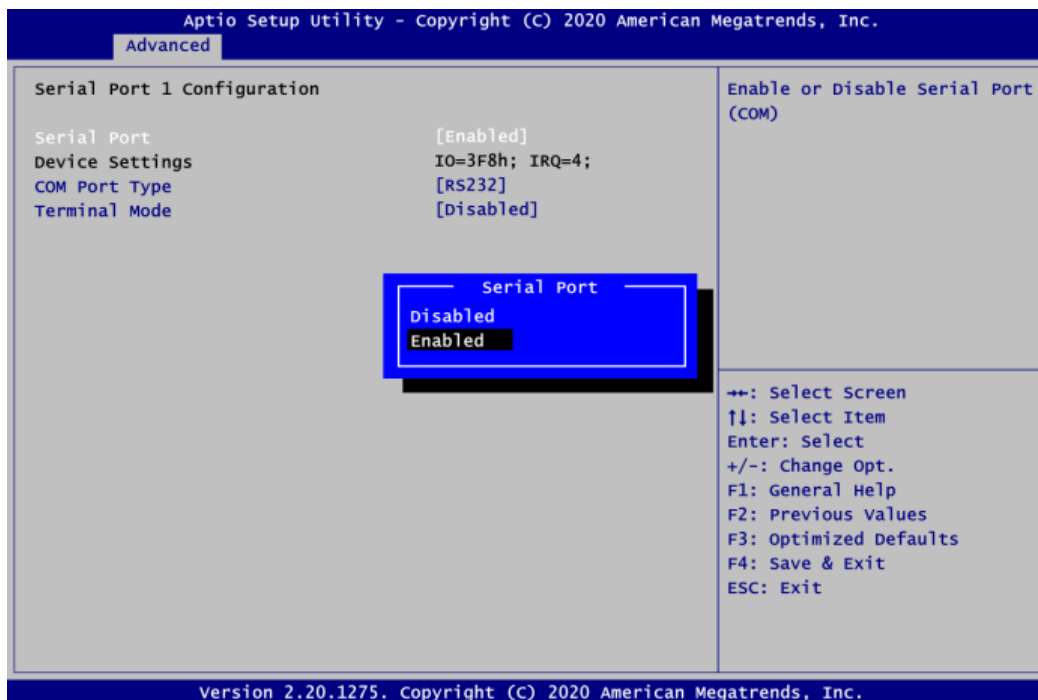

**Serial Port**

Enable or disable serial port 1. The optimal setting for base I/O address is 3F8h and for interrupt request address is IRQ4.

**COM Port Type**

Use this item to set RS-232/422/485 communication mode.

**Terminal Mode**

Use this item to enable the RS-422/485 termination resistor to enhance the signal.

- **Serial Port 2 Configuration**

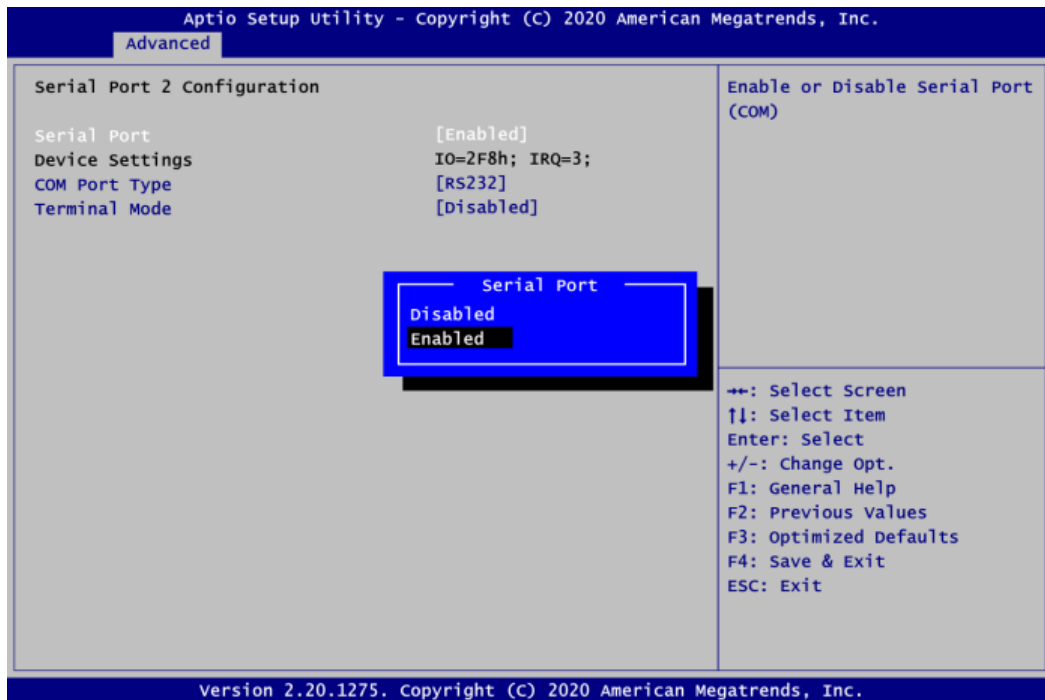
**Serial Port**

Enable or disable serial port 2. The optimal setting for base I/O address is 2F8h and for interrupt request address is IRQ3.

**COM Port Type**

Use this item to set RS-232/422/485 communication mode.

**Terminal Mode**

Use this item to enable the RS-422/485 termination resistor to enhance the signal.

- **Hardware Monitor**

This screen monitors hardware health status.

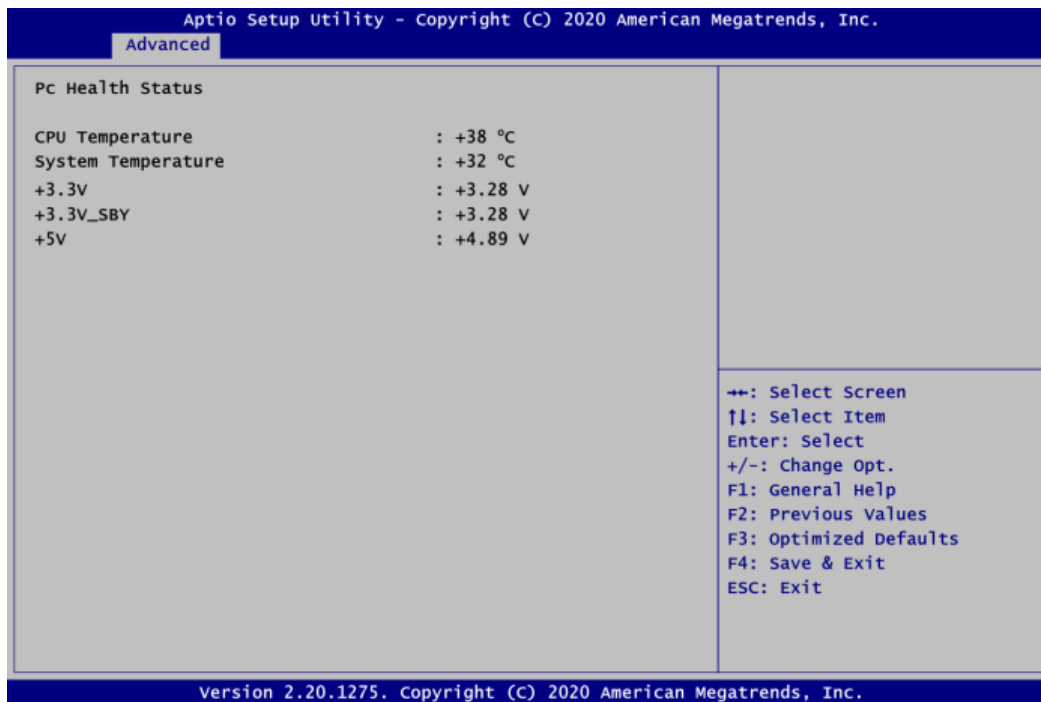

This screen displays the temperature of system and CPU, system voltages (+3.3V, +3.3V standby and +5V).



- **ACPI Settings**

You can use this screen to select options for the ACPI configuration, and change the value of the selected option. A description of the selected item appears on the right side of the screen.

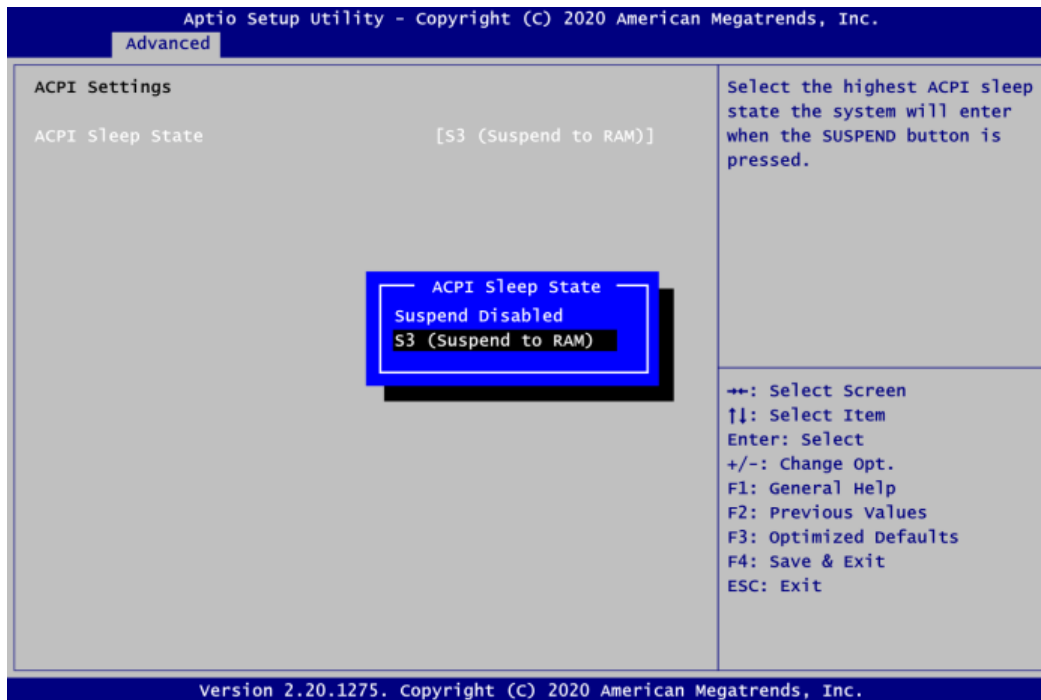
**ACPI Sleep State**

Select the ACPI (Advanced Configuration and Power Interface) sleep state. The S3 (Suspend to RAM) option selects ACPI sleep state the system will enter when suspend button is pressed.

- **CPU Configuration**

This screen shows the CPU Configuration and you can change the value of the selected option.

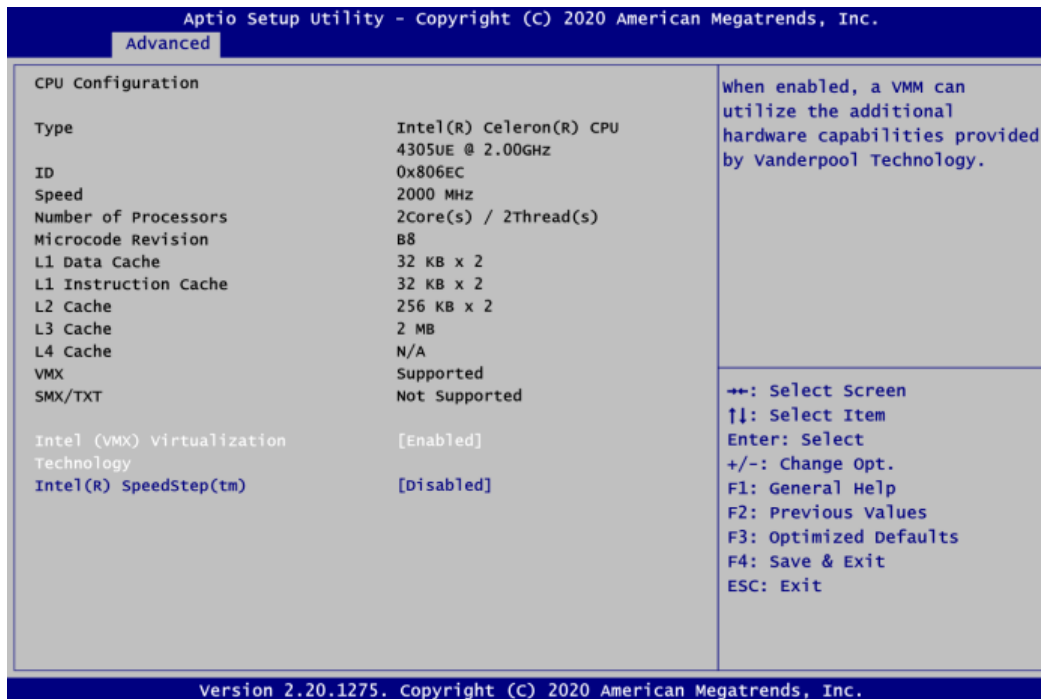

**Intel Virtualization Technology**

Enable or disable Intel® Virtualization Technology. When enabled, a VMM (Virtual Machine Mode) can utilize the additional hardware capabilities. It allows a platform to run multiple operating systems and applications independently, hence enabling a computer system to work as several virtual systems.

**Intel(R) SpeedStep(tm)**

The processor will control the frequency dynamically. When it is enabled, the option of Turbo Mode will be showed.

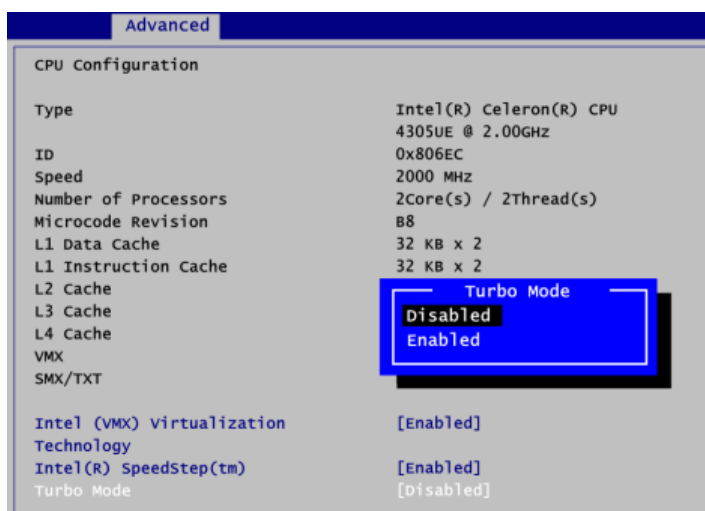

**Turbo Mode**

Enable or disable processor Turbo Mode. The processor can be up to maximum turbo frequency when the system loading becomes higher.

- **SATA Configuration**

During system boot up, the BIOS automatically detects the presence of SATA devices. In the SATA Configuration menu, you can see the hardware currently installed in the SATA ports.

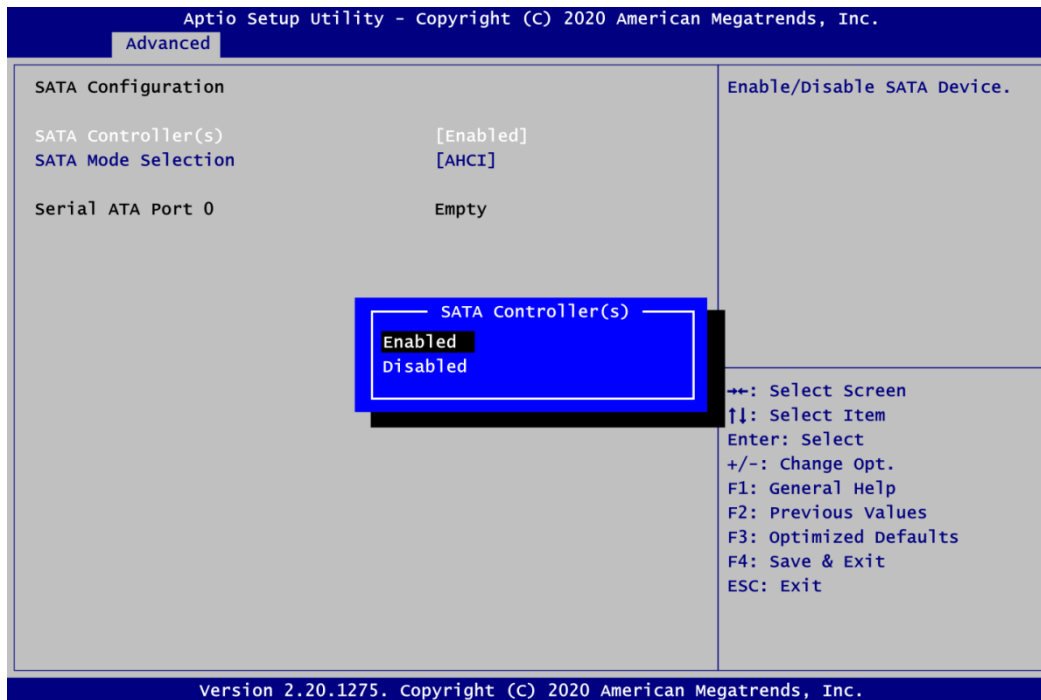
**SATA Controller(s)**

Enable or disable the SATA Controller feature. The default is Enabled.

**SATA Mode Selection**

Determine how SATA controller(s) operate.

- **PCH-FW Configuration**

This screen displays ME Firmware information.



- **AMT Configuration**

Use this screen to configure AMT parameters.

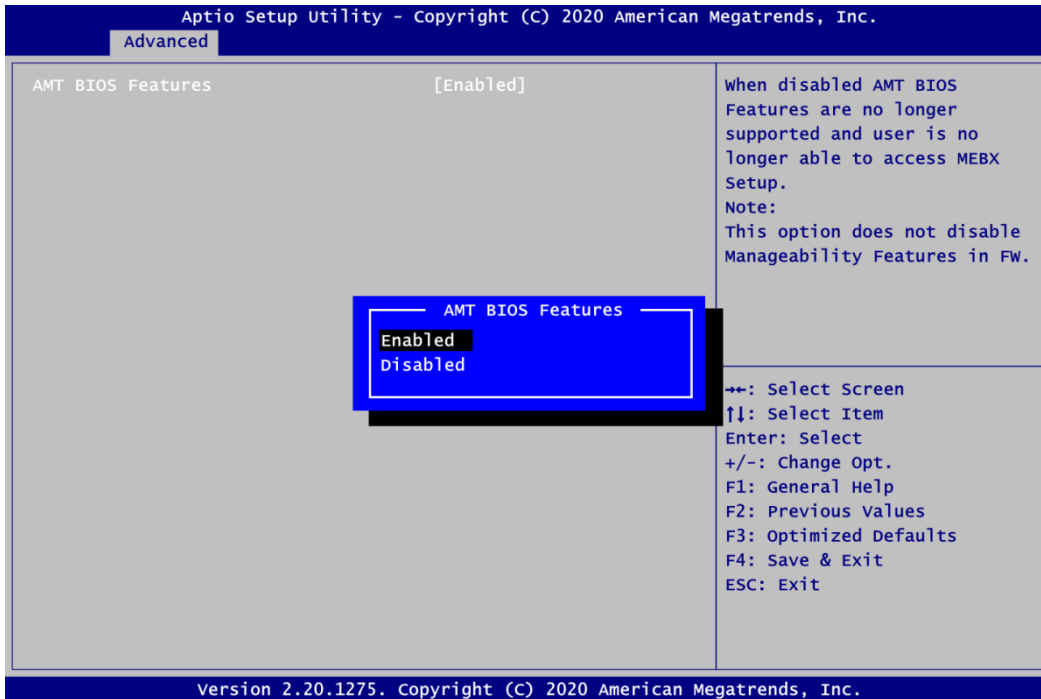

**AMT BIOS Features**

Enable or disable Active Management Technology BIOS features. The default is Enabled. Note that this screen will be empty, if the CPU does not support Intel® AMT, see image below.

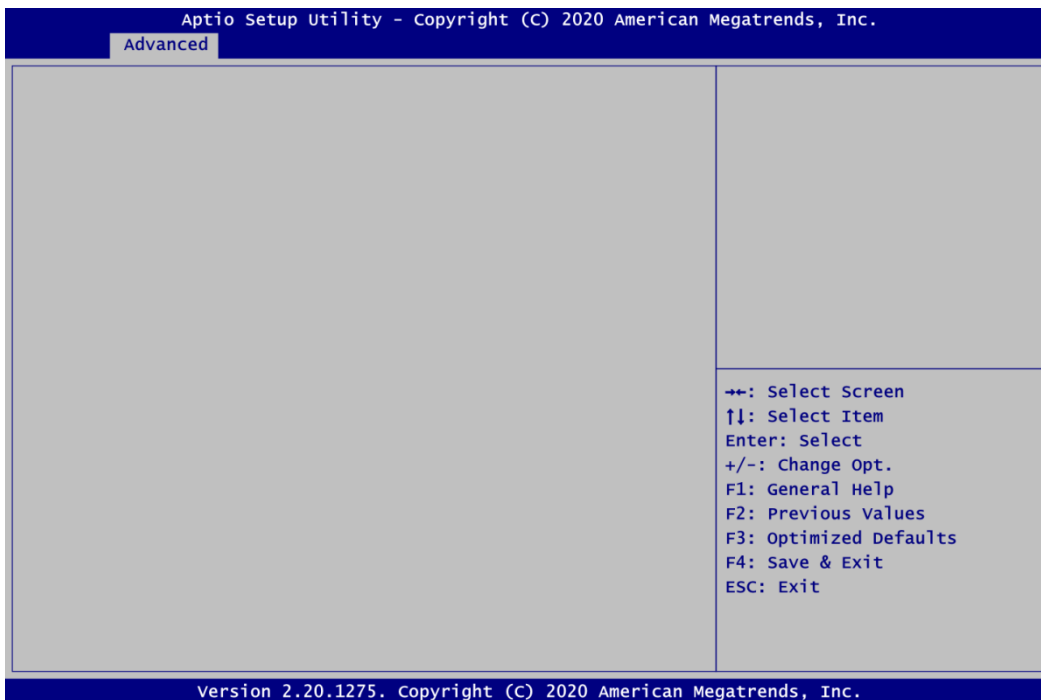

- **USB Configuration**

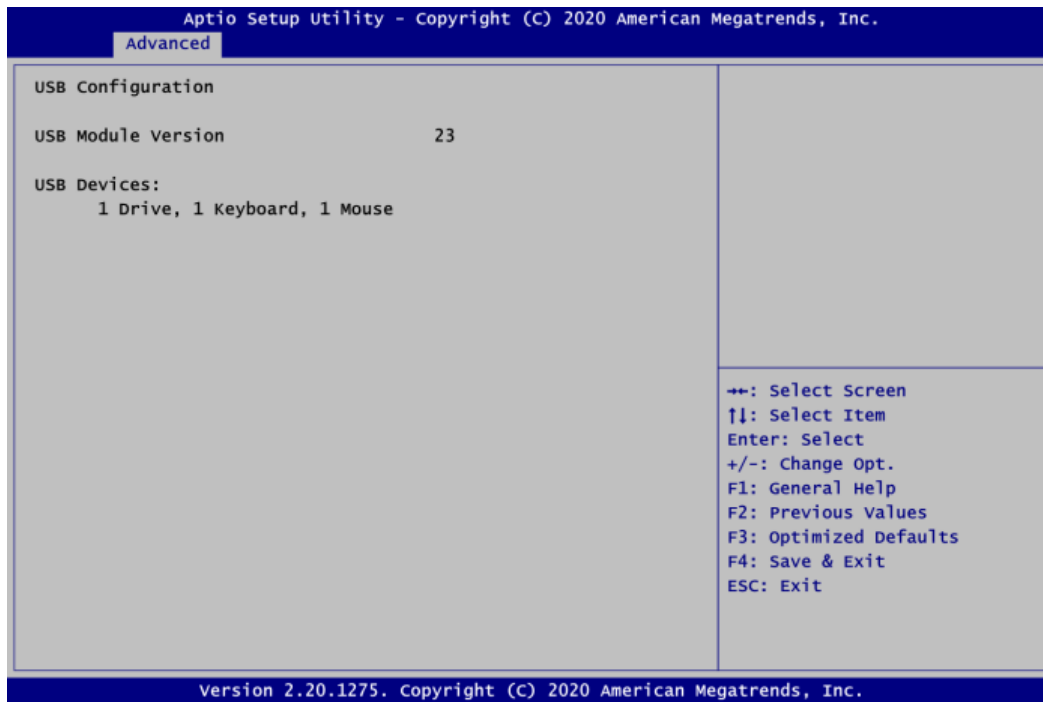

**USB Devices**

Display all detected USB devices.

## 4.5 Chipset Menu

The Chipset menu allows users to change the advanced chipset settings. You can select any of the items in the left frame of the screen to go to the sub menus:

- ▶ System Agent (SA) Configuration
- ▶ PCH-IO Configuration

For items marked with “▶”, please press <Enter> for more options.

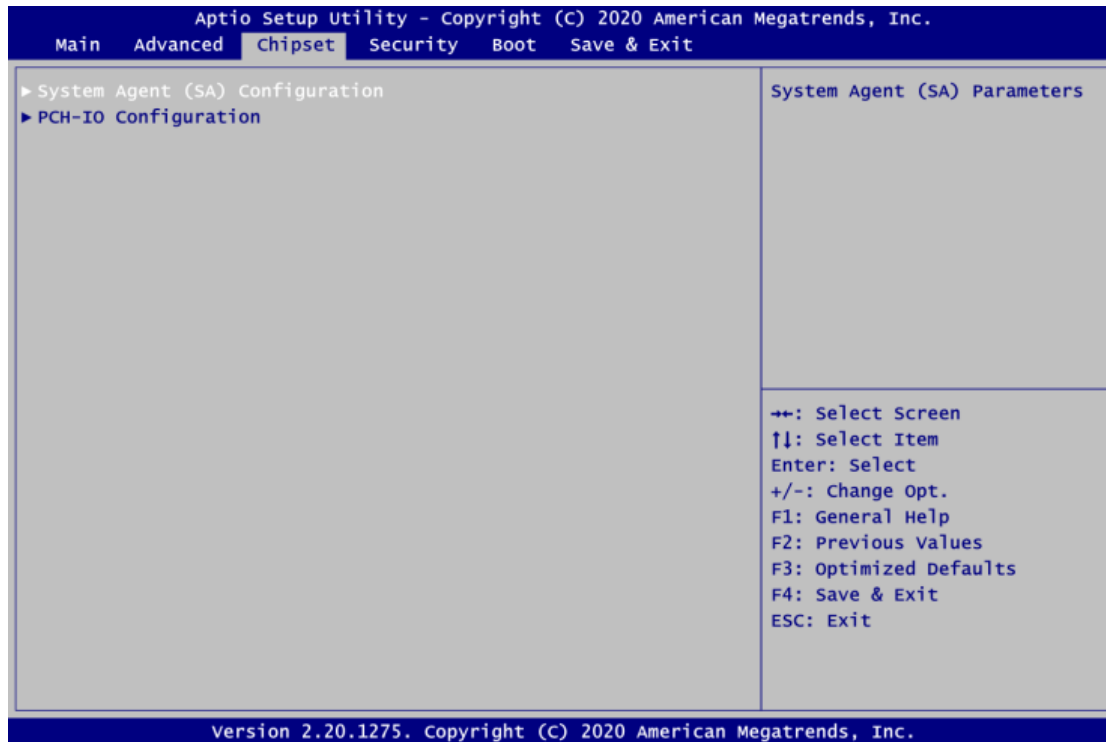

- **System Agent (SA) Configuration**

This screen allows users to configure System Agent (SA) parameters. For items marked with “▶”, please press <Enter> for more options.



**Graphics Configuration**

Open sub menu for parameters related to graphics configuration.

**Memory Configuration**

Open sub menu for information related to system memory.



- **Graphics Configuration**

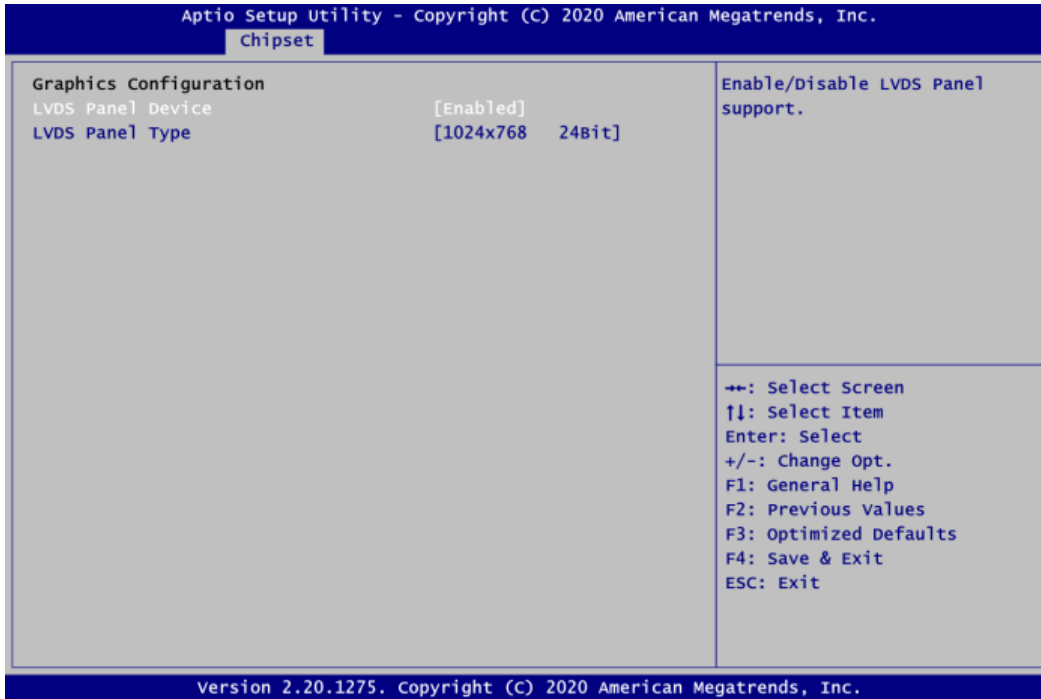

**LVDS Panel Device**

Enable or disable LVDS panel device.

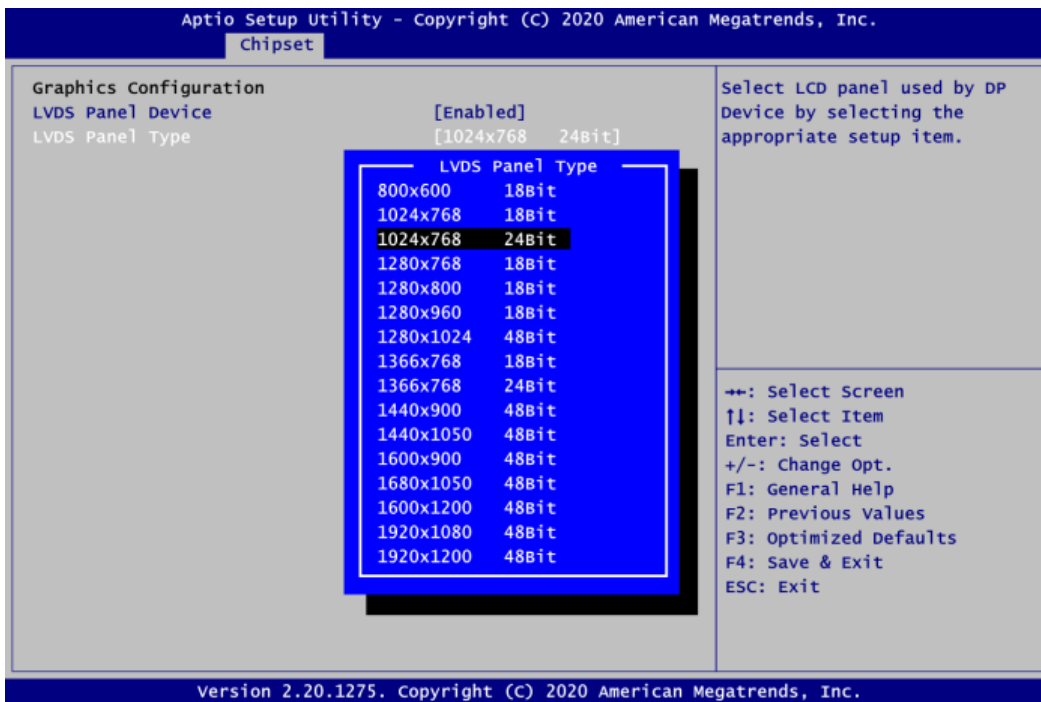

**LVDS Panel Type**

Select the appropriate LVDS panel resolution; see the selection options in image above.

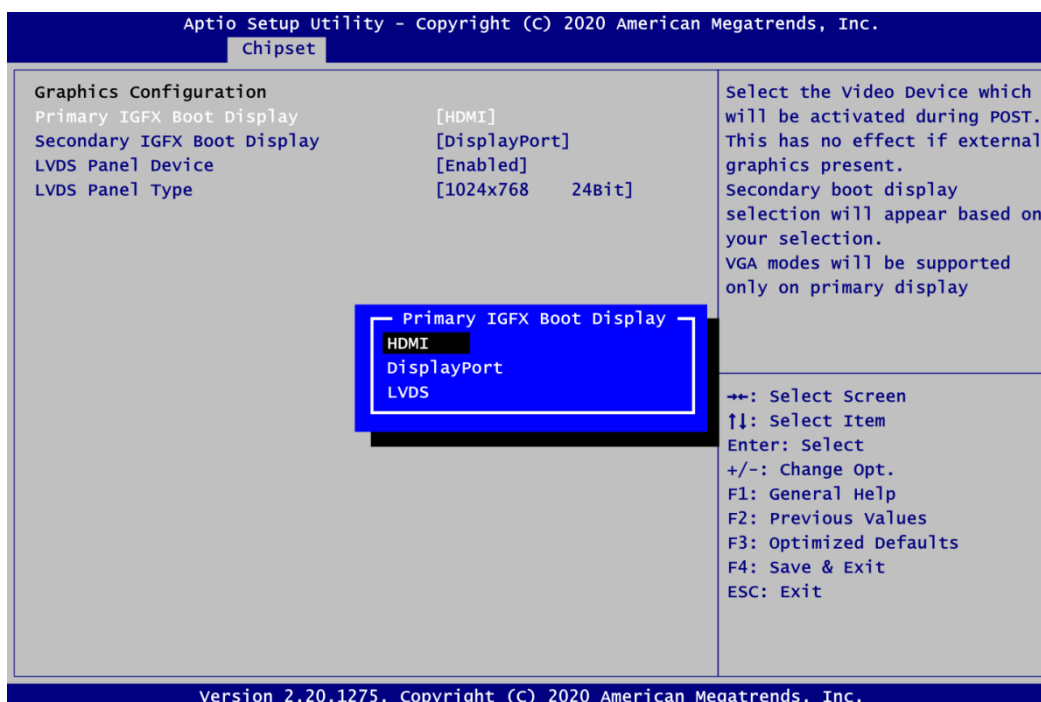

### Primary IGFX Boot Display

Select the video device which will be activated during POST (Power-On Self Test). The default is HDMI.

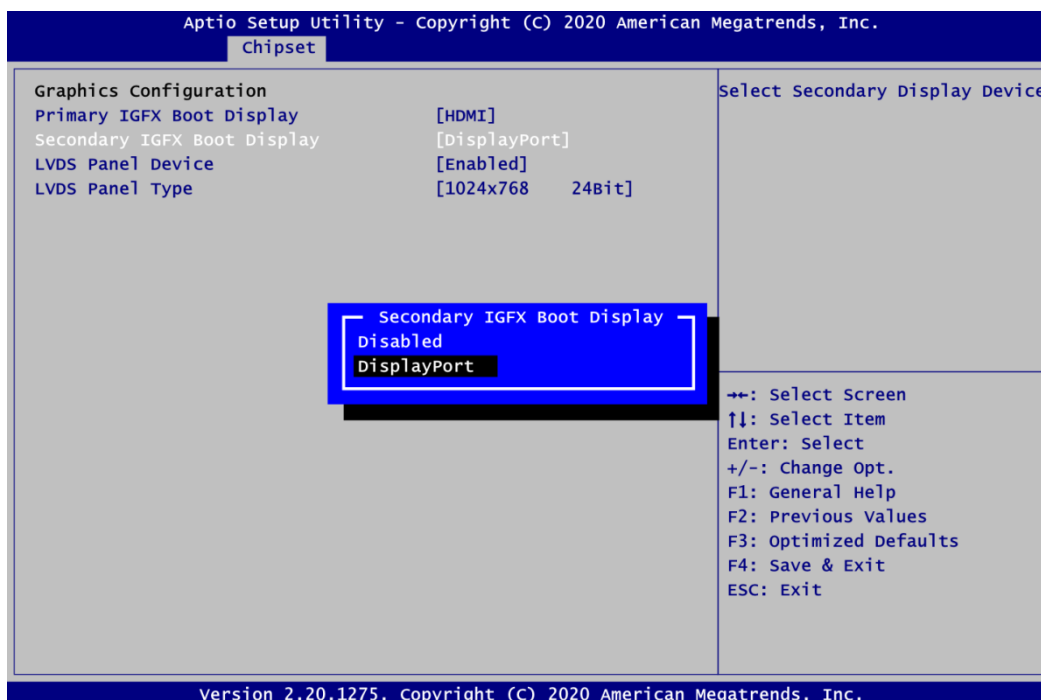

### Secondary IGFX Boot Display

Select secondary display device. The default is DisplayPort.



Note

1. These two setup items are only supported in Legacy Mode (refer to section 4.7 Boot Mode).
2. LVDS can only be the Primary IGFX Boot Display.

- **Memory Configuration**

This screen shows system memory information.

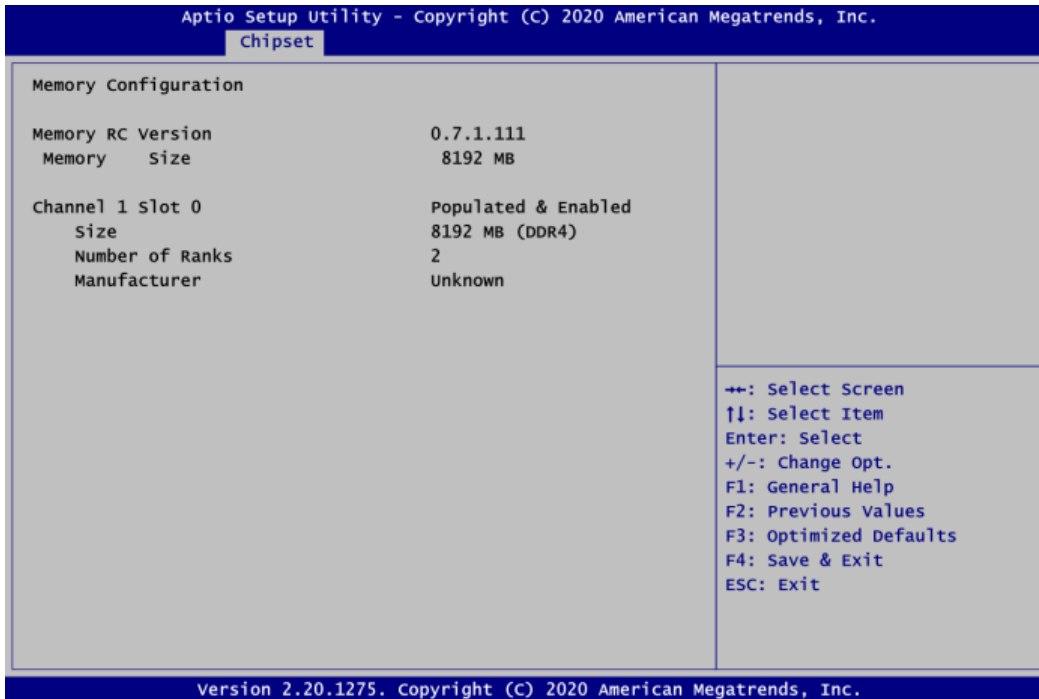

- **PCH-IO Configuration**

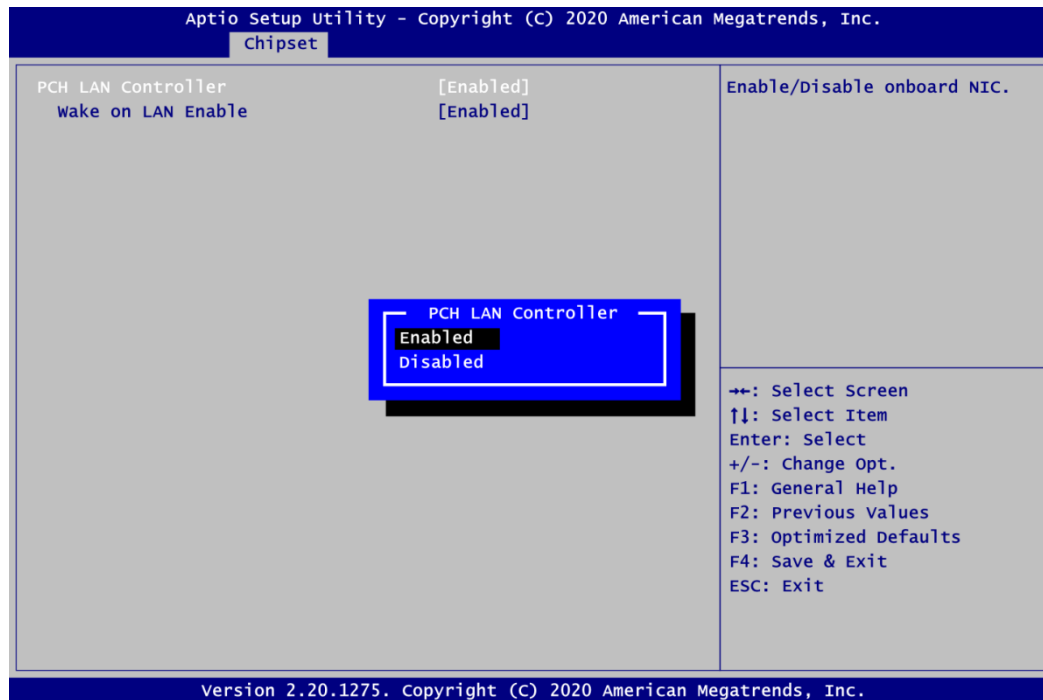

**PCH LAN Controller**

Enable or disable onboard PCH LAN controller.

**Wake on LAN Enable**

After enabling PCH LAN Controller, enabling or disabling integrated LAN to wake the system.

## 4.6 Security Menu

The Security menu allows users to change the security settings for the system.



- **Administrator Password**  
Set administrator password.
- **User Password**  
Set user password.

## 4.7 Boot Menu

The Boot menu allows users to change boot options of the system.

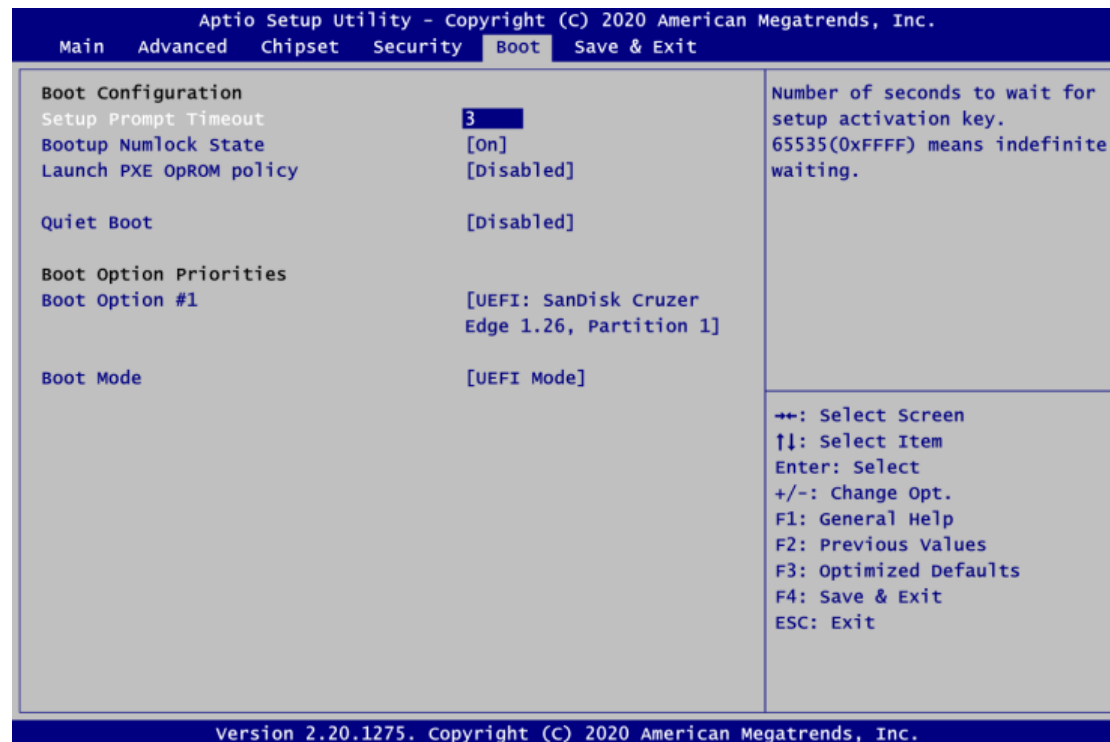

- **Setup Prompt Timeout**  
Number of seconds to wait for setup activation key. 65535(0xFFFF) means indefinite waiting.
- **Bootup Numlock State**  
Use this item to select the power-on state for the keyboard NumLock.
- **Launch PXE OpROM policy**  
Control the execution of UEFI and Legacy Network OpROM.
- **Quiet Boot**  
Select to display either POST output messages or a splash screen during boot-up.
- **Boot Option Priorities**  
These are settings for boot priority. Specify the boot device priority sequence from the available devices.
- **Boot Mode**  
Use this option for boot mode settings.
  - UEFI Mode: Select support to boot any UEFI-capable OS.
  - Legacy Mode: Select support to boot non UEFI-capable OS that expects a legacy BIOS interface.

## 4.8 Save & Exit Menu

The Save & Exit menu allows users to load your system configuration with optimal or fail-safe default values.

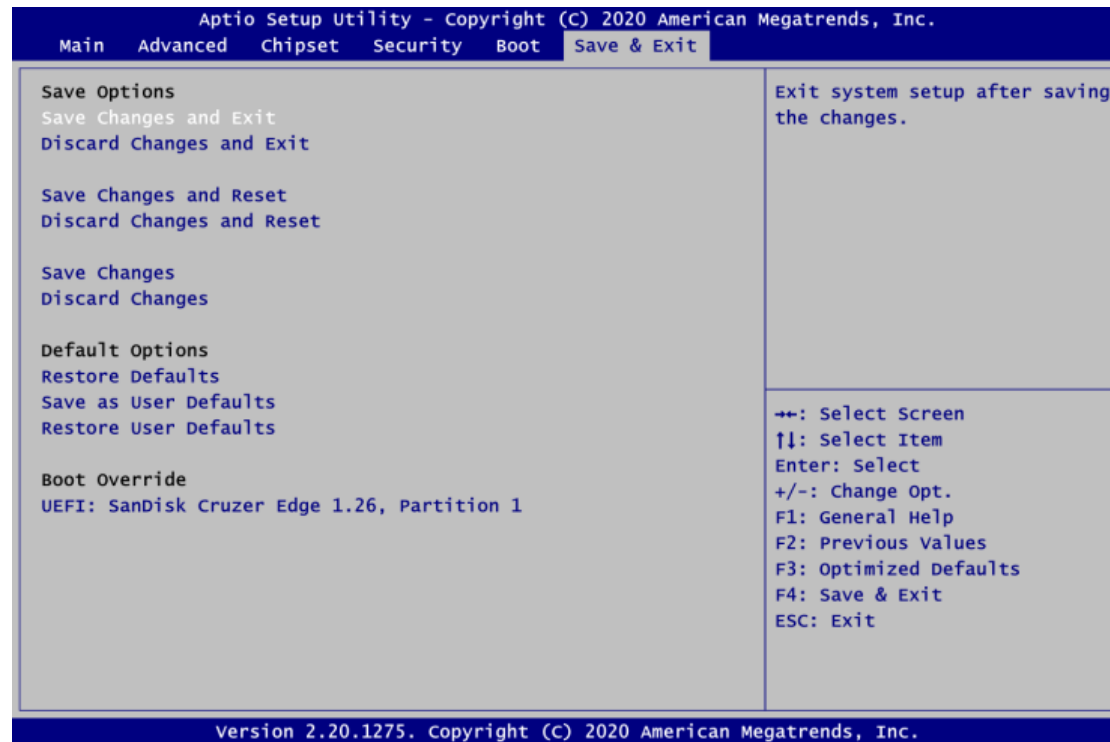

- Save Changes and Exit**  
 When you have completed the system configuration changes, select this option to leave Setup and return to Main Menu. Select Save Changes and Exit from the Save & Exit menu and press <Enter>. Select Yes to save changes and exit.
- Discard Changes and Exit**  
 Select this option to quit Setup without making any permanent changes to the system configuration and return to Main Menu. Select Discard Changes and Exit from the Save & Exit menu and press <Enter>. Select Yes to discard changes and exit.
- Save Changes and Reset**  
 When you have completed the system configuration changes, select this option to leave Setup and reboot the computer so the new system configuration parameters can take effect. Select Save Changes and Reset from the Save & Exit menu and press <Enter>. Select Yes to save changes and reset.
- Discard Changes and Reset**  
 Select this option to quit Setup without making any permanent changes to the system configuration and reboot the computer. Select Discard Changes and Reset from the Save & Exit menu and press <Enter>. Select Yes to discard changes and reset.
- Save Changes**  
 When you have completed the system configuration changes, select this option to save changes. Select Save Changes from the Save & Exit menu and press <Enter>. Select Yes to save changes.

- **Discard Changes**  
Select this option to quit Setup without making any permanent changes to the system configuration. Select Discard Changes from the Save & Exit menu and press <Enter>. Select Yes to discard changes.
- **Restore Defaults**  
It automatically sets all Setup options to a complete set of default settings when you select this option. Select Restore Defaults from the Save & Exit menu and press <Enter>.
- **Save as User Defaults**  
Select this option to save system configuration changes done so far as User Defaults. Select Save as User Defaults from the Save & Exit menu and press <Enter>.
- **Restore User Defaults**  
It automatically sets all Setup options to a complete set of User Defaults when you select this option. Select Restore User Defaults from the Save & Exit menu and press <Enter>.
- **Boot Override**  
Select a drive to immediately boot that device regardless of the current boot order.



# Appendix A

## Watchdog Timer

### A.1 About Watchdog Timer

After the system stops working for a while, it can be auto-reset by the watchdog timer. The integrated watchdog timer can be set up in the system reset mode by program.

### A.2 How to Use Watchdog Timer

Assembly sample code :

```
mov     dx,fa10           ; 5 seconds (Maximum is 65535 seconds; fill in
                        ; 0xFA10 and 0xFA11 register, ex: 0xFA11=0x01,
                        ; 0xFA10=0x68 means 360 seconds)
mov     al,05
out     dx,al

mov     dx,fa12           ; Enable WDT
mov     al,01
out     dx,al
```

**This page is intentionally left blank.**

# Appendix B

## Digital I/O

### B.1 About Digital I/O

The onboard GPIO or digital I/O has 4 bits (DIO1~4). Each bit can be set to function as input or output by software programming. In default, all pins are pulled high with +5V level (according to main power). The BIOS default settings are 2 inputs and 2 outputs.

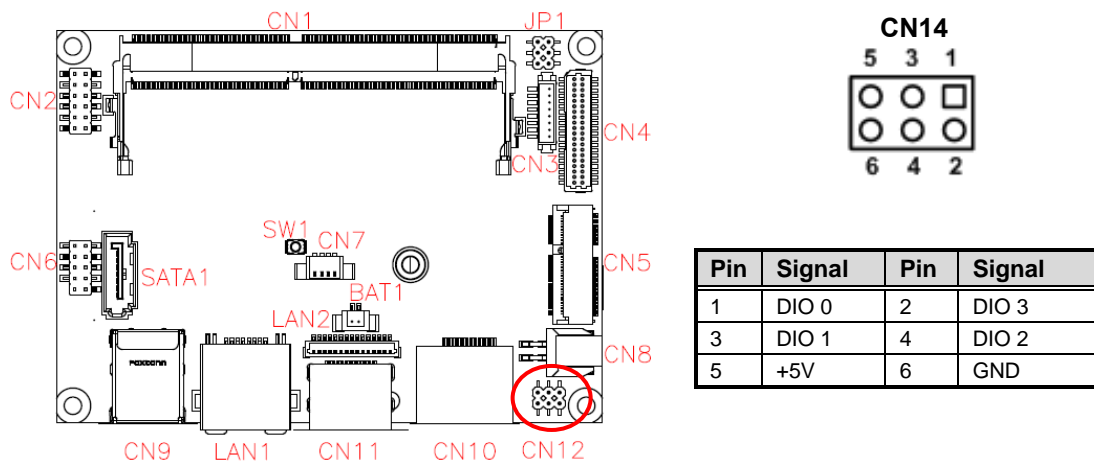

### B.2 Digital I/O Programming

Assembly sample code :

```

mov    dx,fa31          ; Set DIO 0-3 to Output
mov    al,00
out    dx,al

mov    dx,fa32          ; Set DIO 2-3 to High
mov    al,0c
out    dx,al

mov    dx,fa31          ; Set DIO 0-3 to Input
mov    al,0f
out    dx,al

mov    dx,fa32          ; Get DIO 0-3 status
in     al,dx

mov    dx,fa31          ; Set DIO 0-1 to Input, 2-3 to Output
mov    al,03            ; al = 03 => 00000011
out    dx,al

mov    dx,fa32          ; Set DIO 3 to High
mov    al,08            ; al = 08 => 00001000
out    dx,al

in     al,dx            ; Get DIO 0-2 status
    
```

**This page is intentionally left blank.**

# Appendix C

## iAMT Settings

The Intel® Active Management Technology (Intel® iAMT) has decreased a major barrier to IT efficiency that uses built-in platform capabilities and popular third-party management and security applications to allow IT a better discovering, healing, and protection their networked computing assets.

In order to utilize Intel® iAMT you must enter the ME BIOS (<Ctrl + P> during system startup), change the ME BIOS password, and then select “Intel® iAMT” as the manageability feature.

### C.1 Entering MEBx

1. Go to BIOS to enable iAMT function (see section 4.4).
2. Exit from BIOS after starting iAMT, and press <Ctrl + P> to enter MEBx Setting.



Note

*It is better to press <Ctrl + P> before the screen popping out.*

### C.2 Set and Change Password

1. You will be asked to set a password when first log in. The default password is “admin”.

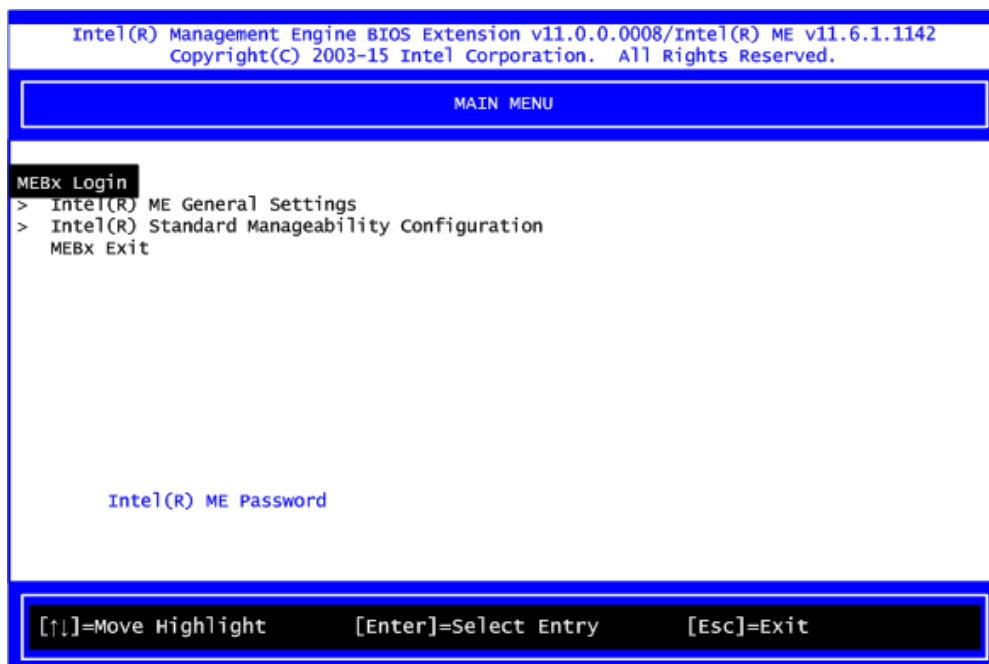

2. You will be asked to change the password before setting ME.
3. You must confirm your new password while revising. The new password must contain: (example: **!!11qqQQ**) (default value).
  - Eight characters
  - One upper case
  - One lower case
  - One number
  - One special symbol, such as ! ` \$ or ; ` ( ` " , excepted)

Underline ( \_ ) and space are valid characters for password, but they won't make higher complexity.

4. From Main Menu, select ME General Settings to get into ME Platform Configuration screen. In this screen you can modify Local FW Update setting.

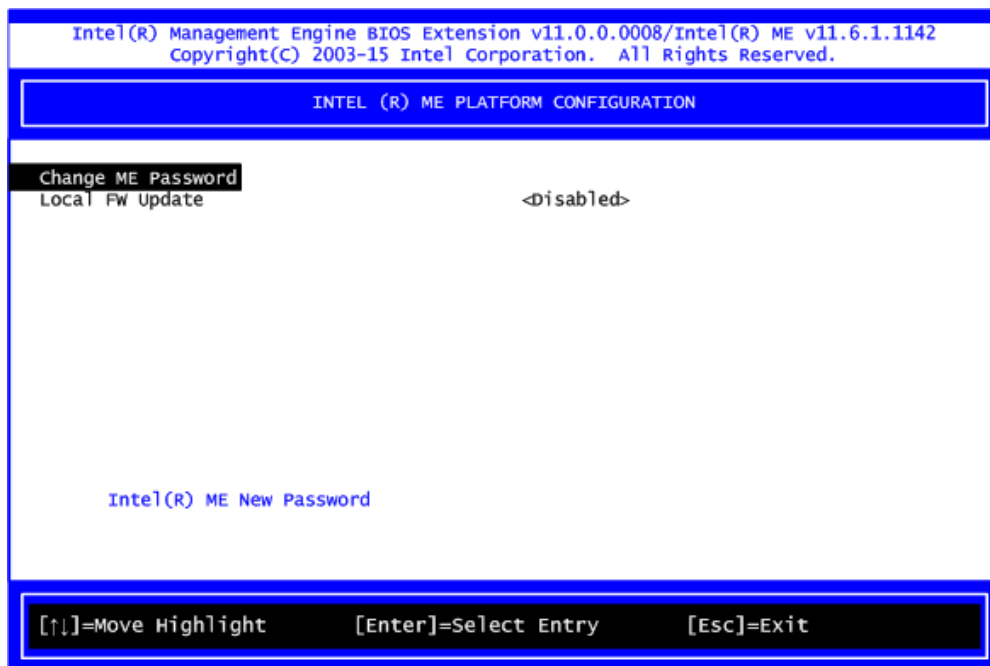

5. Return to Main Menu.

### C.3 iAMT Configuration

1. From Main Menu, select Intel® Standard Manageability Configuration and press <Enter>.
2. Set Manageability Feature Selection to Enabled.

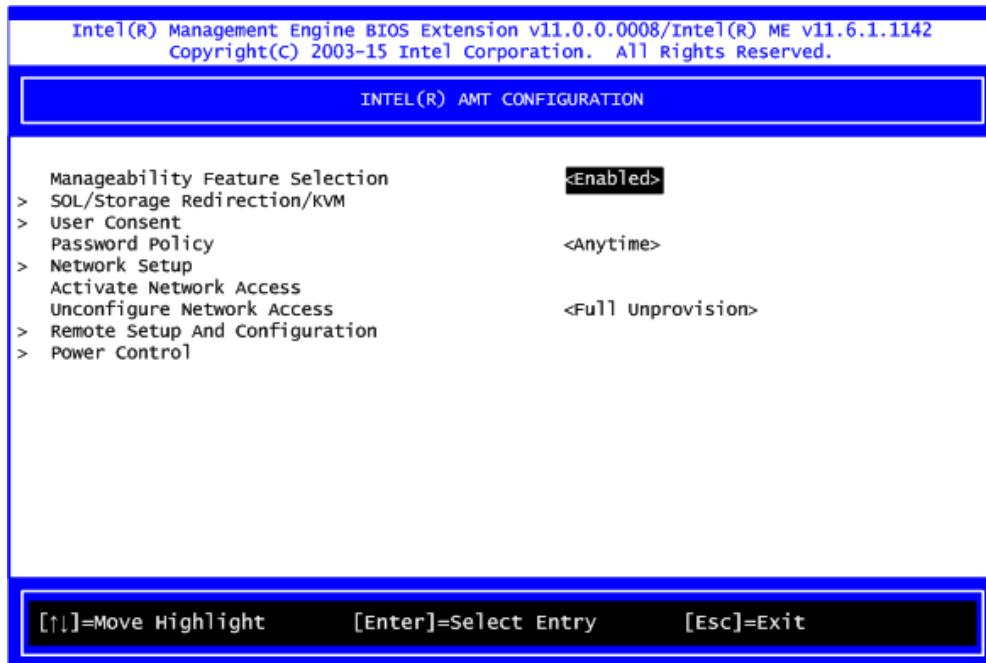

- **SOL/Storage Redirection/KVM**

This screen is for enabling or disabling Serial-over-LAN (SOL)/Storage Redirection/Keyboard Video Mouse (KVM) functionality.

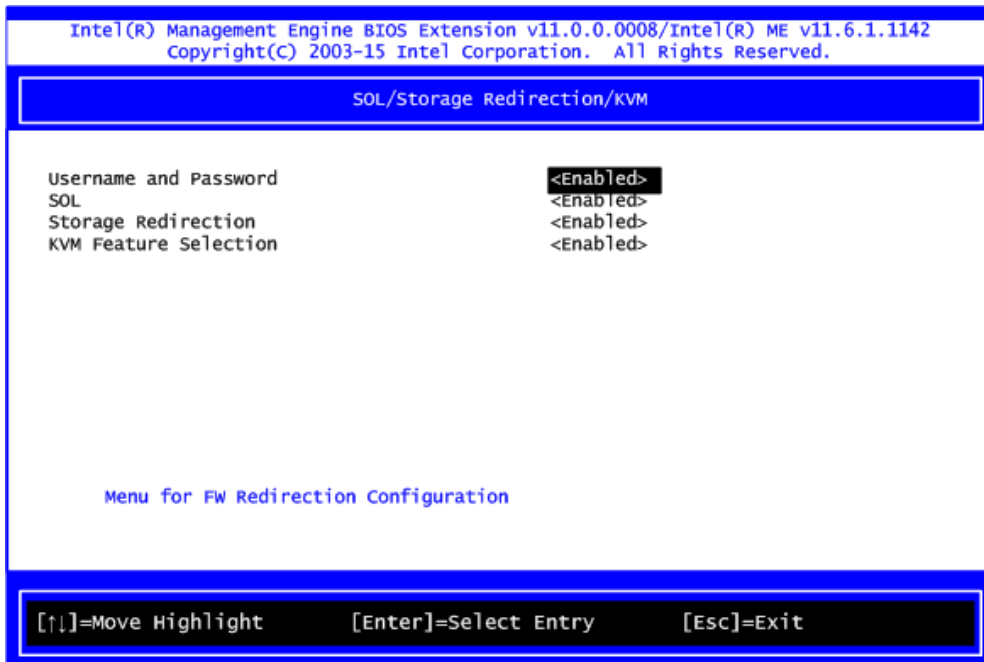

- **User Consent**

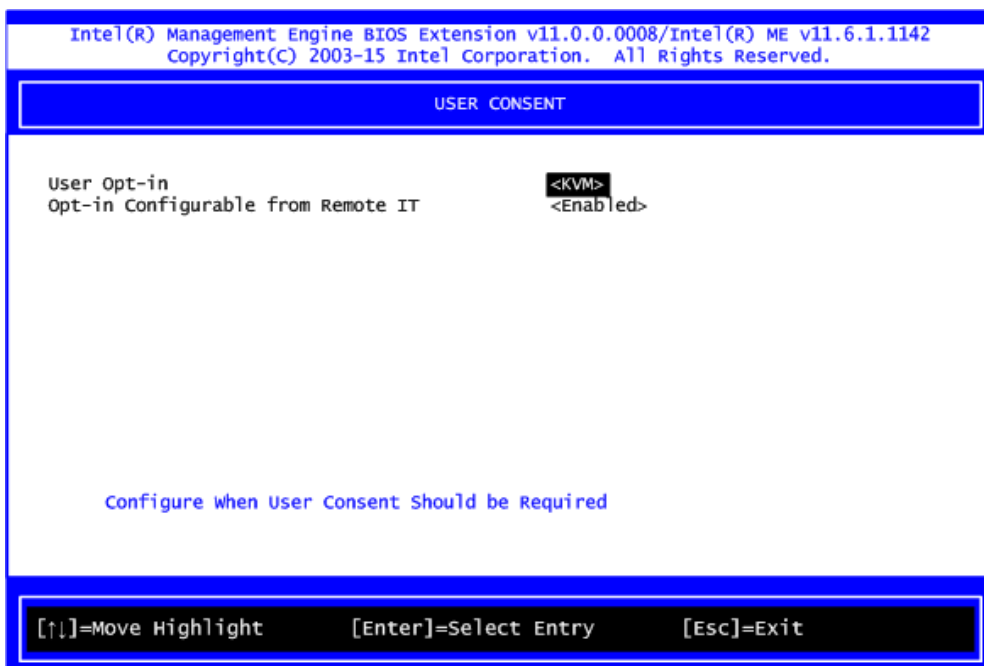

**User Opt-in**

Configure this item when user consent should be required.

**Opt-in Configurable from Remote IT**

Enable or disable remote change capability of user consent feature.



- **Network Setup**

1. From Intel® AMT Configuration Menu, select Network Setup.
2. Select ME Network Name Settings to set computer host and domain name.

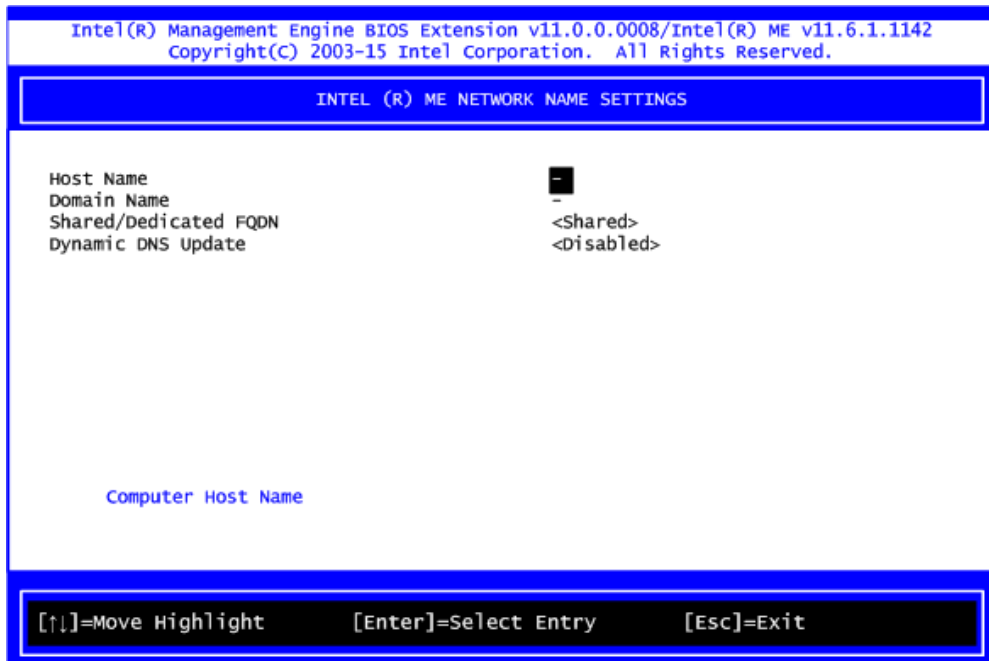
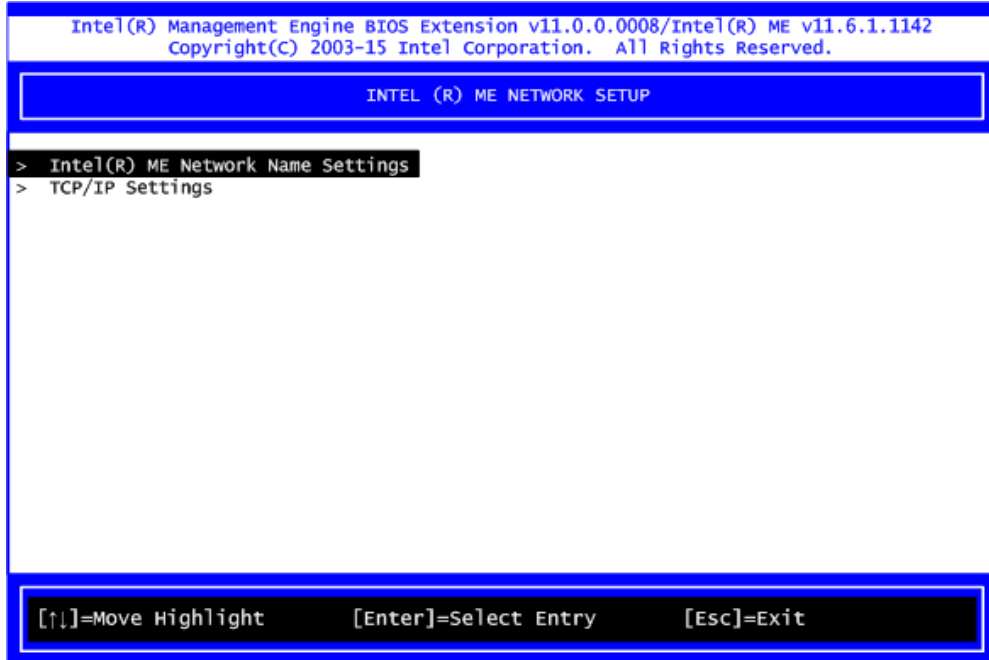

3. Select TCP/IP to get into Network interface. Get into DHCP Mode and set it to Disabled.

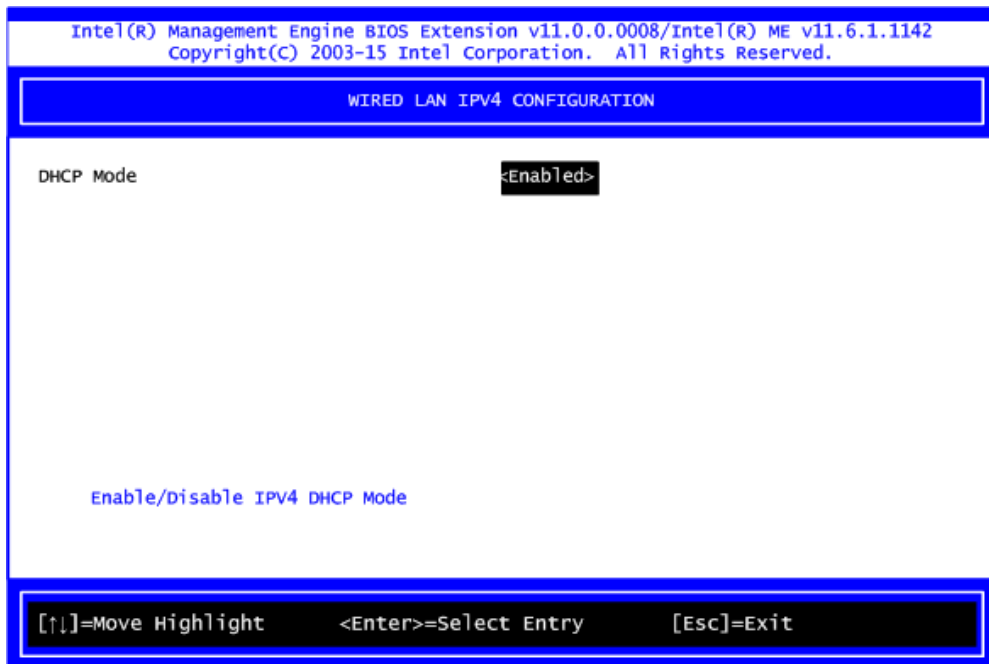
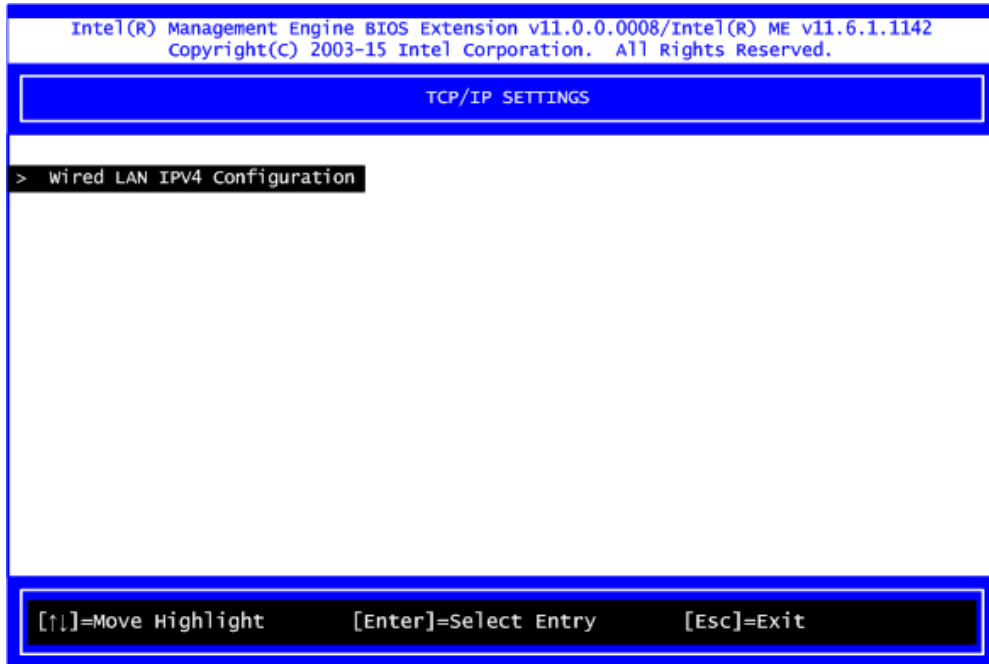

4. If DHCP Mode is disabled, set the following settings:
  - IP address
  - Subnet mask

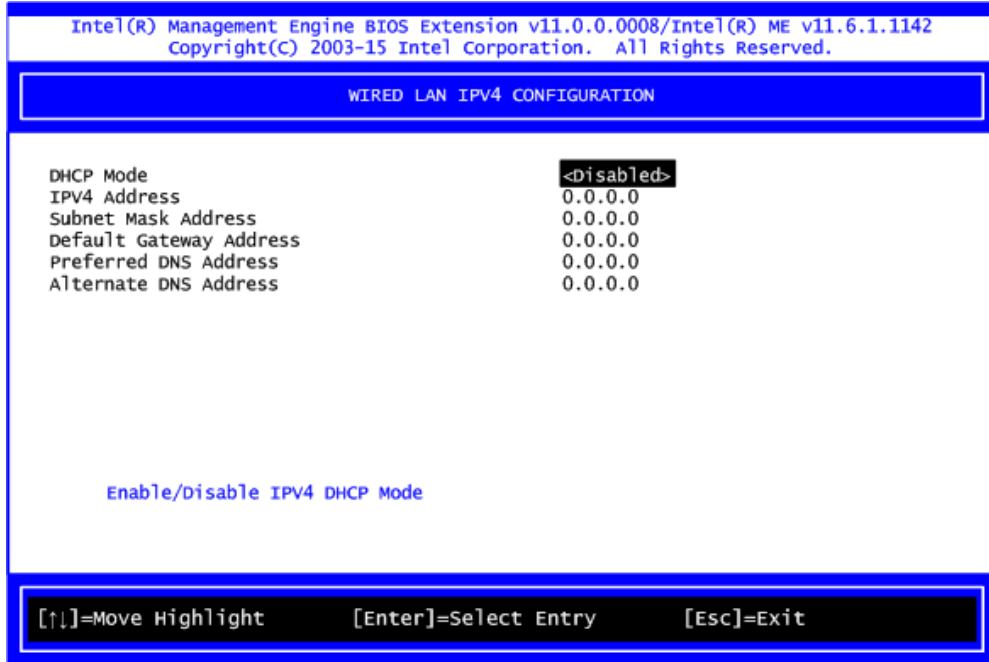

5. Go back to Intel® iAMT Configuration, then select Activate Network Access and press <Enter>.

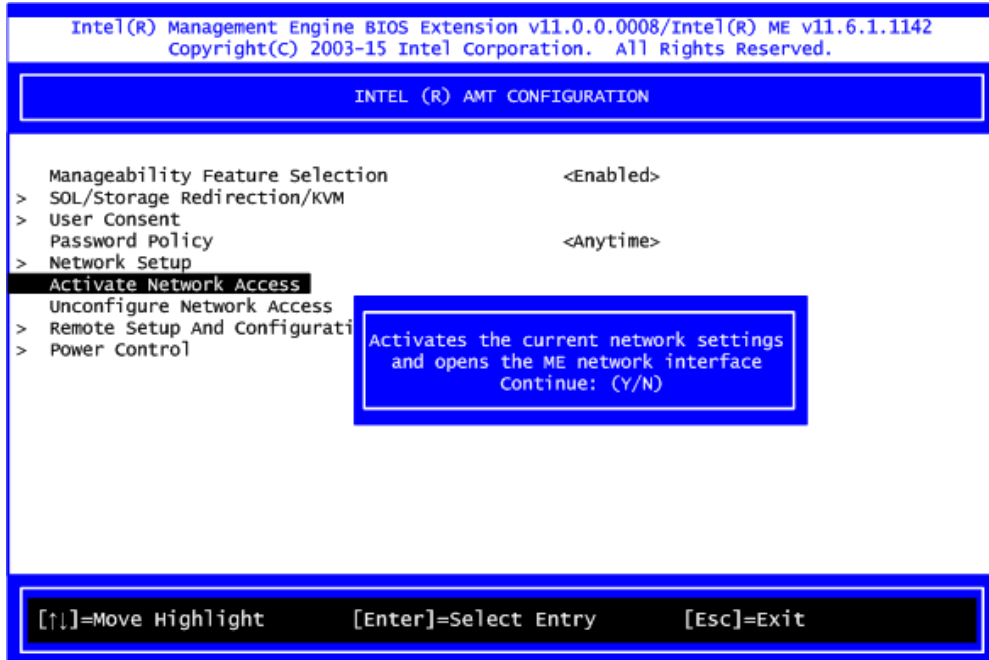

6. Exit from MEBx after completing the iAMT settings.

- Remote Setup and Configuration

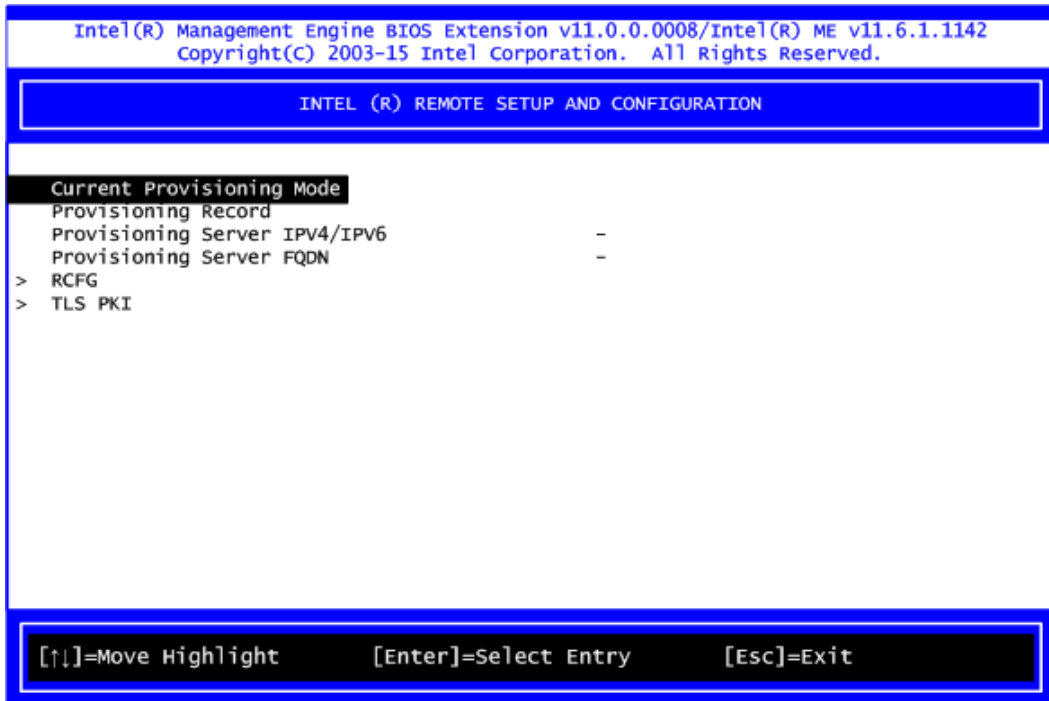

1. Select TLS PKI to get into remote configuration screen. Then select Start Configuration to activate it.

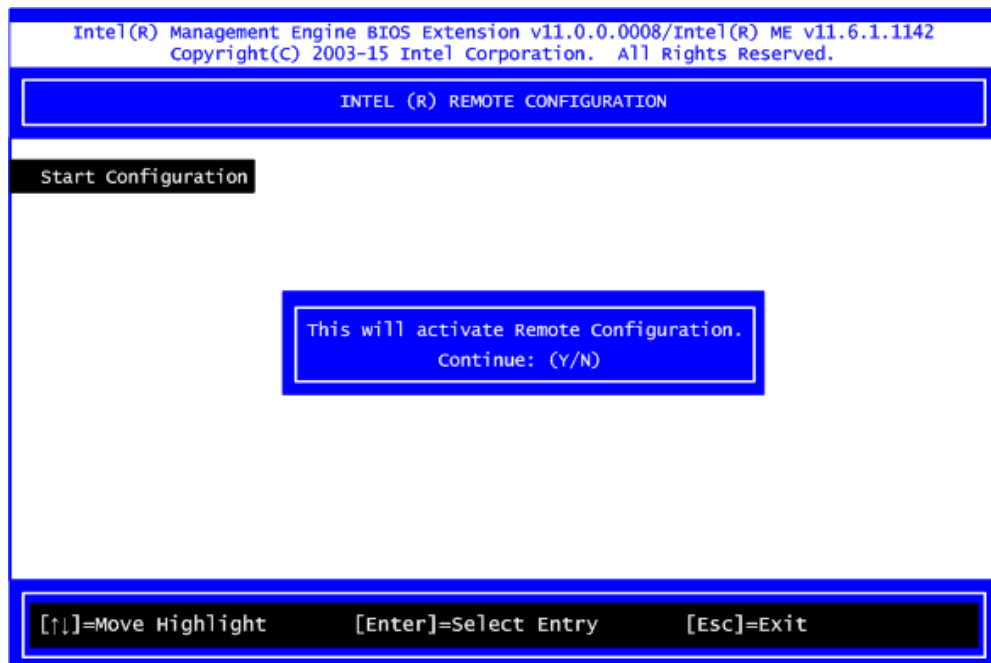

2. Select Manage Hashes to add, delete and activate hash.

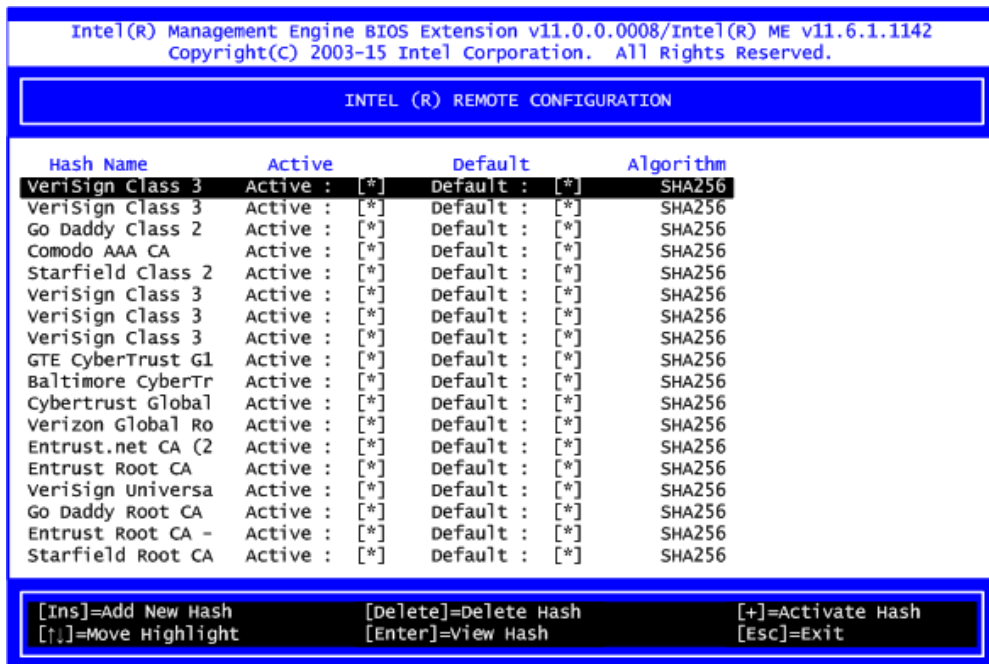
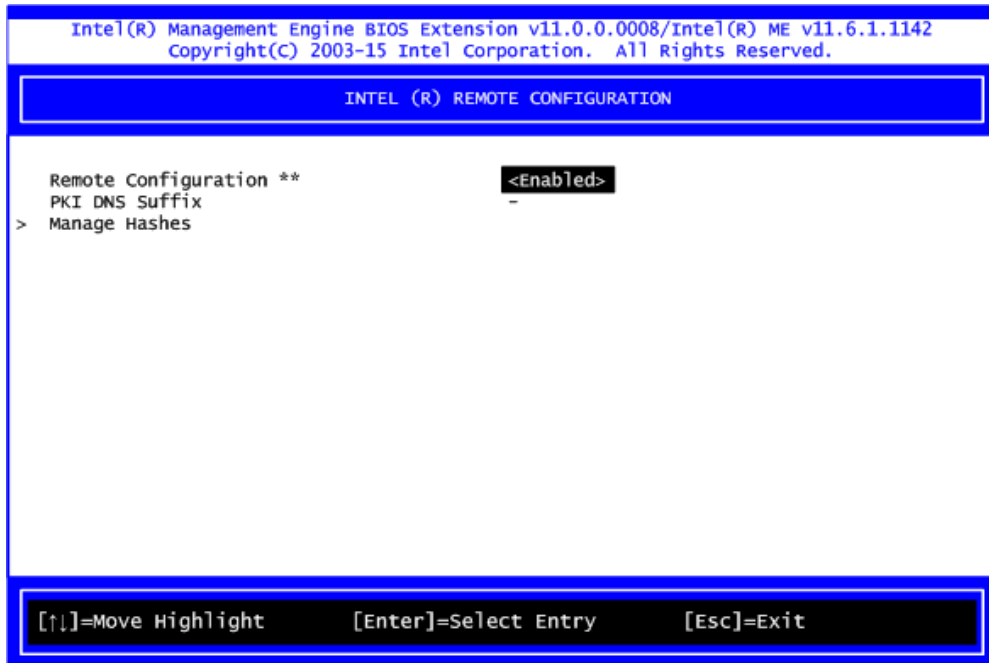

- **Power Control**

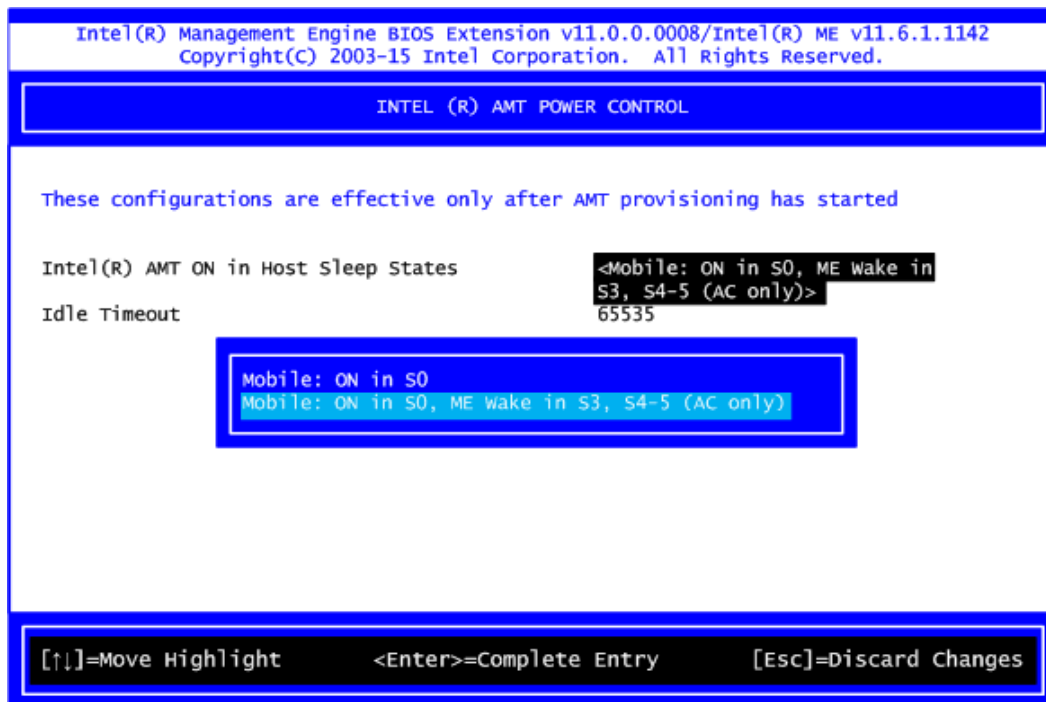

**AMT ON in Host Sleep States**

Select the appropriate AMT ON in Host Sleep States setting. Options are ON in S0 and ON in S0, ME Wake in S3, S4-5 (AC only).

**Idle Timeout**

This is timeout value for Wake\_On\_ME in minutes. It must be set to a non-zero value.

## C.4 iAMT Web Console

1. From a web browser, please type `http://(IP ADDRESS):16992`, which connects to iAMT Web.

Example: <http://10.1.40.214:16992>

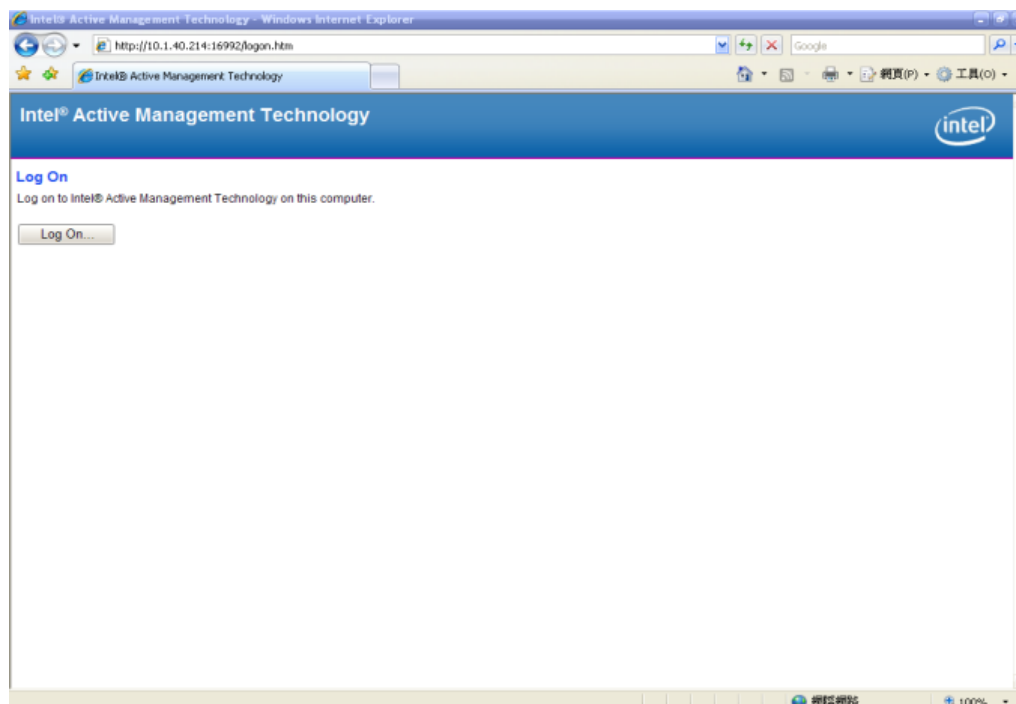

2. To log on, you will be required to type in username and password for access to the Web.

USER: admin (default value)

PASS: (MEBx password)

3. Enter the iAMT Web.

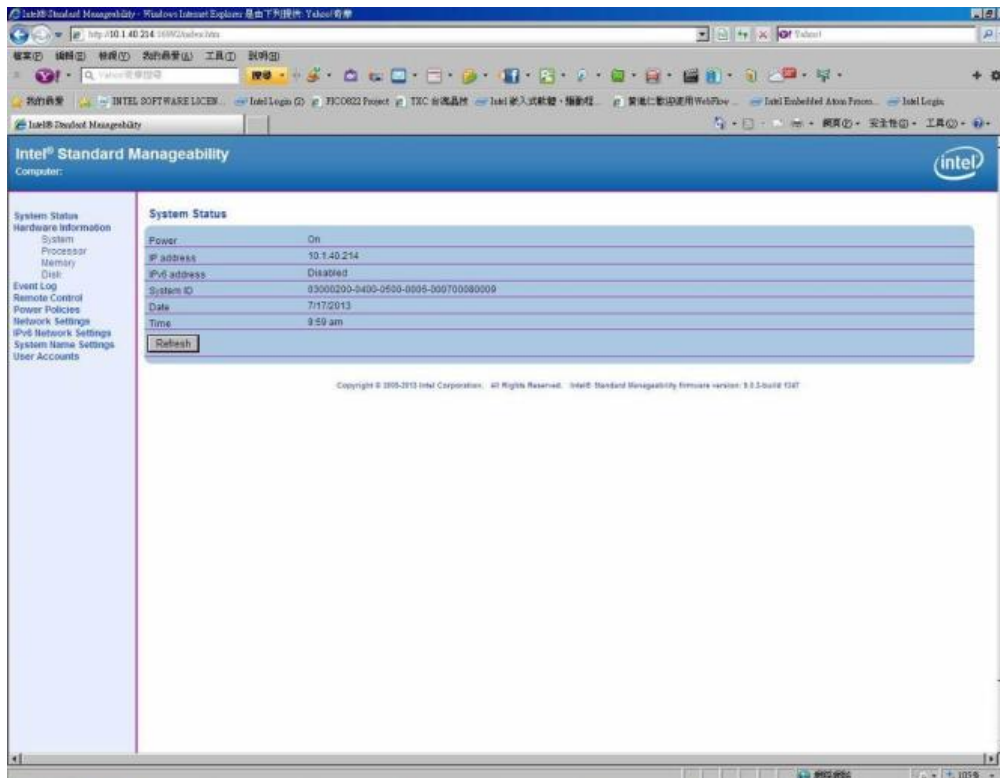

4. Click Remote Control, and select commands on the right side.

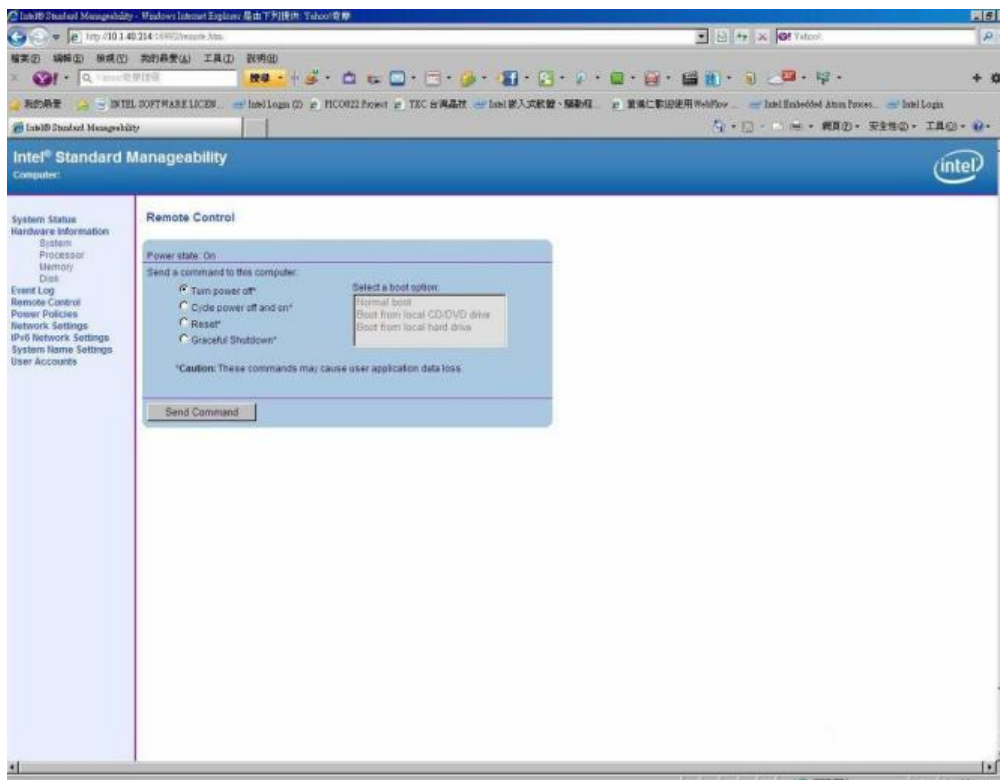

5. When you have finished using the iAMT Web console, close the Web browser.