

USER'S MANUAL

NA592 Series

SMB Network Appliance

User's Manual



www.axiomtek.com

Disclaimers

This manual has been carefully checked and believed to contain accurate information. Axiomtek Co., Ltd. assumes no responsibility for any infringements of patents or any third party's rights, and any liability arising from such use.

Axiomtek does not warrant or assume any legal liability or responsibility for the accuracy, completeness or usefulness of any information in this document. Axiomtek does not make any commitment to update the information in this manual.

Axiomtek reserves the right to change or revise this document and/or product at any time without notice.

No part of this document may be reproduced, stored in a retrieval system, or transmitted, in any form or by any means, electronic, mechanical, photocopying, recording, or otherwise, without the prior written permission of Axiomtek Co., Ltd.

CAUTION

If you replace wrong batteries, it causes the danger of explosion. It is recommended by the manufacturer that you follow the manufacturer's instructions to only replace the same or equivalent type of battery and dispose of used ones.

©Copyright 2021 Axiomtek Co., Ltd.

All Rights Reserved

August 2021, Version A1

Printed in Taiwan

Safety Approvals

- ◆ CE Marking
- ◆ FCC Class A

◆ FCC Compliance

This equipment has been tested and complies with the limits for a Class A digital device, pursuant to Part 15 of the FCC Rules. These limits are designed to provide reasonable protection against harmful interference in a residential installation. If not installed and used in accordance with proper instructions, this equipment might generate or radiate radio frequency energy and cause harmful interference to radio communications. However, there is no guarantee that interference will not occur in a particular installation. If this equipment does cause harmful interference to radio or television reception, which can be determined by turning the equipment off and on, the user is encouraged to try to correct the interference by one or more of the following measures:

- Reorient or relocate the receiving antenna.
- Increase the separation between the equipment and receiver.
- Connect the equipment into an outlet on a circuit different from that to which the receiver is connected.
- Consult the dealer or an experienced radio/TV technician for help.
- Shielded interface cables must be used in order to comply with emission limits.

Safety Precautions

Before getting started, read the following important cautions.

1. Be sure to ground yourself to prevent static charge when installing the internal components. Use a grounding wrist strap and place all electronic components in any static-shielded devices. Most electronic components are sensitive to static electrical charge.
2. Disconnect the power cords from the NA592 Series before making any installation. Be sure both the system and the external devices are turned OFF. Sudden surge of power could ruin sensitive components. Make sure the NA592 series is properly grounded.
3. Do not open the system's top cover. If opening the cover for maintenance is a must, only a trained technician is allowed to do so. Integrated circuits on computer boards are sensitive to static electricity. To avoid damaging chips from electrostatic discharge, observe the following precautions:
 - Before handling a board or integrated circuit, touch an unpainted portion of the system unit chassis for a few seconds. This will help to discharge any static electricity on your body.
 - When handling boards and components, wear a wrist-grounding strap, available from most electronic component stores.

Trademarks Acknowledgments

Axiomtek is a trademark of Axiomtek Co., Ltd.

Windows[®] is a trademark of Microsoft Corporation.

IBM, PC/AT, PS/2, VGA are trademarks of International Business Machines Corporation.

Intel[®] and Pentium[®] are trademarks of Intel Corporation.

AMI is trademark of American Megatrend Inc.

Other brand names and trademarks are the properties and registered brands of their respective owners.

Table of Contents

Disclaimers.....	ii
Safety Approvals.....	iii
Safety Precautions.....	iv
Section 1 Introduction	1
1.1 General Description	1
1.2 Feature	1
1.3 Specifications.....	2
1.4 Dimensions and Outlines	5
1.5 I/O Outlets	6
1.5.1 Front Panel.....	6
1.5.2 Rear Panel	8
Section 2 Hardware and Installation	9
2.1 Check List.....	9
2.2 Board Layout	10
2.3 Jumper Settings	12
2.3.1 RTC/CMOS Clear Jumper (JP1)	13
2.3.2 TACT SW1 Function Selection Jumper (JP3/Lower Button).....	13
2.3.3 LAN Bypass Control Jumper (JP6/JP7/JP9).....	14
2.3.4 Case open (JP8)	14
2.3.5 CRT always on (JP10)	15
2.3.6 Auto Power Button Model Jumper (JP12).....	15
2.4 Connectors	16
2.4.1 ATX 2*4 pin +12V CPU Power Connector (ATX1)	17
2.4.2 ATX 2*2 pin +12V Power Connector (ATX2).....	17
2.4.3 Serial Port2 Connector (COM2) Co-lay CN6	17
2.4.4 ATX 24 pin Power Connector (CN1)	18
2.4.5 Nano SIM card slot (CN2)	18
2.4.6 M.2 E-key 2230 (CN3)	19
2.4.7 M.2 B-key 2242 (CN4)	20
2.4.8 Mini Card Connector (CN5).....	21
2.4.9 LCM Connector (CN6)	22
2.4.10 1X2 SFP Connector (CN7).....	22
2.4.11 USB3.0 and console Connector (CN9)	23
2.4.12 2*4 RJ45 Connector (CN10)	23
2.4.13 Front Panel Bezel Connector (CN11).....	24
2.4.14 Digital input/output Connector (DIO1).....	25

2.4.15	FAN Connectors (FAN1~FAN3)	25
2.4.16	Serial ATA Connectors (SATA1 & SATA2)	25
2.4.17	USB2.0 Port Connector (USB1)	26
2.4.18	VGA pin header (VGA1)	26
2.5	Hardware Installation	27
2.5.1	Installing the CPU	27
2.5.2	Installing the Memory	28
2.5.3	Installing the Hard Disks	29
Section 3	AMI BIOS Setup Utility	31
3.1	Starting	31
3.2	Navigation Keys	31
3.3	Main Menu	32
3.4	Advanced Menu	33
3.5	Chipset Menu	49
3.6	Security Menu	53
3.7	Boot Menu	54
3.8	Save & Exit Menu	55
Appendix A	LAN Bypass Configuration	61
	About LAN Bypass	61
	LAN Bypass Register Configuration	62
Appendix B	WDT Timer for System Reset	65
Appendix C	LAN Module Expansion	67
	LAN Bypass Control Jumper (JP2/JP3)	67
Appendix D	Warning	75

Section 1

Introduction

This chapter contains general information and detailed specifications of the NA592 Series Network Appliance Server. It contains the following sections:

- General Description
- Features
- Specifications
- Dimensions and Outlines
- I/O Outlets

1.1 General Description

The NA592 is a 1U rackmount network appliance based on Intel® Xeon W1200/ the 10th Generation Core i Processors with Intel® W480E Chipset (Comet lake), The appliance sets the target at greatly improved CPU performance. It provides greater performance and power efficiency to equipment providers.

For greater flexibility, the NA592 has two front-accessible expansion slots that allow developers to expand two different LAN modules based on their solution requirements. This expansions need to be requested before production. The two expandable LAN modules via the PCIe 3.0 interface, support max up to 16 LAN ports. To avoid the influences of shutdown by the environment, the NA592's motherboard supports data protection via 2 pairs of latch-type LAN bypass for fail-over option.

For storing event log data, the NA592 utilizes two 2.5" SATA HDDs or one 3.5" SATA HDD (optional). And NA592 supports dual channel up to 128GB DDR4-2933 non-ECC/ECC memory and one standard PCIe x8 expansion slot for optional network security card.

The NA592 is designed for network enterprise business. NA592 not only provides high performance processor, memory, storage interface and LAN connection, but also includes outstanding management capability.

1.2 Feature

- Intel® Comet Lake Xeon® Processor W1200 Family and 10th Core i9/i7/i5/i3 processors
- Four UDIMM sockets up to 128GB none-ECC / ECC memory (DDR4 2933)
- Supports two LAN modules expansion (optional)
- Supports BIOS redirected to COM port
- Supports two 2.5" SATA HDDs or one 3.5" SATA HDD (optional)
- Suitable for VPN, network bandwidth controller, firewall applications

1.3 Specifications

System

- **System CPU**
 - Intel® Comet Lake Xeon® Processor W1200 Family and 10th Core i7/i5/i3 processors

- **System Chipset**
 - Intel® W480E

- **System Memory**
 - 4 x DDR4 2933 DIMM sockets, up to 128GB none-ECC / ECC memory

- **BIOS**
 - AMI 256Mbit PnP Flash BIOS with function of BIOS redirected to COM port

- **Storage**
 - Two 2.5" SATA HDDs or one 3.5" SATA HDD (optional)
 - One M.2 2242 Key B slot (SATA interface)

- **TPM**
 - 2.0 on board

- **LAN**
 - The default is 10 x 10/100/1000Mbps (8x RJ45 & 2 x SFP)LAN ports and 2 pairs LAN bypass

NA592: Expandable up to 26 LAN ports via LAN modules.

- **LAN Modules**

Slim Module	Ports	Chipset	Bypass	NA592
GbE Copper Modules				
AX93316-8GI	8	Intel i350	0	v
AX93316-8GIL	8	Intel i350	4	v
AX93326-8GIL	8	Intel 210AT	4	v
AX93336-4GI	4	Intel i211AT	0	v
AX93336-4GIL	4	Intel i350	2	v
GbE Fiber Modules				
AX93322-8FI	8	Intel i350	0	v
AX93322-8MIL	4+4	Intel i350	2	v
AX93336-4FI	4	Intel i350	0	v
10GbE Copper Modules				
AX93317-2GIL	2	Intel X540	1	v
10GbE Fiber Modules				
AX93307-2FI	2	Intel 82599ES	0	v
AX93307-2FIL	2	Intel 82599ES	1	v
AX93327-4FI	4	Intel XL710	0	v
25GbE Fiber Modules				
AX93332-25FI	2	Intel XXV710	0	V
40GbE Fiber Modules				
AX93331-2QFI	2	Intel XL710	0	V

- **Super I/O**

- Controller: Nuvoton NCT6102D
- Serial Ports: Total 2 asynchronous ports (2 x RS-232; one is 10-pin header onboard, but RX/TX signal is co-lay used for LCM module connector, the other one is RJ-type connector with Cisco define)

- **I/O Interface**

- One console RJ-type connector, 2 x USB 3.0 connectors and 8 x RJ-45 & 2 x SFP connectors (in default) or up to 26 LAN ports (expandable)
- LED: 1x4 LED for LAN bypass 1~2, Power and HDD
1x2 LED for GPO 1~2
- 2 x LAN modules (optional)
- Tact switch x2 (up : GPI button) \ (down: hardware system reset button)

- **Watchdog Timer**

- One for System Reset: 255 levels, 1-255 sec
- One for LAN bypass: 7 levels, 1-64 sec

- **USB**

- Two USB 3.0 ports one front side, two USB 2.0 are internal pin headers

- **Hardware Monitoring**

- Controller Nuvoton NCT6102D
- CPU temperature, system temperature, power and fan speed detection

- **Expansion Slot**

- Support two LAN modules through AX98621 with two front slots or support one module & one PCIe8 slot through AX98621 with one front slot & AX96708 Riser card.
- For M.2 Key M (PCIe4) can through AX98621 (83986211050E) or ((83986211060E)

- **Power Supply**
 - 300W single power supply in default/400W single power supply by project
 - 400W redundant power supply (1+1)



Note:



Indicates to unplug all AC power cord(s) to disconnect AC Power

- **OS Compatibility**
 - Linux kernel

Mechanical/Environmental

- **Form Factor**
 - 1U rackmount
- **Operation Temperature**
 - 0°C ~ 40°C
- **Storage Temperature**
 - -20°C ~ 70°C
- **Humidity**
 - 10% - 95% RH, non-condensing
- **Chassis Material**
 - Iron
- **Dimensions**
 - 44mm (1.73") (H) x 430mm (16.84") (W) x 450mm (20.59") (D)
- **Certificate**
 - FCC class A / CE class A



Note: *All specifications and images are subject to change without notice.*

1.4 Dimensions and Outlines

The following diagram shows you dimensions and outlines of the NA592 Series.

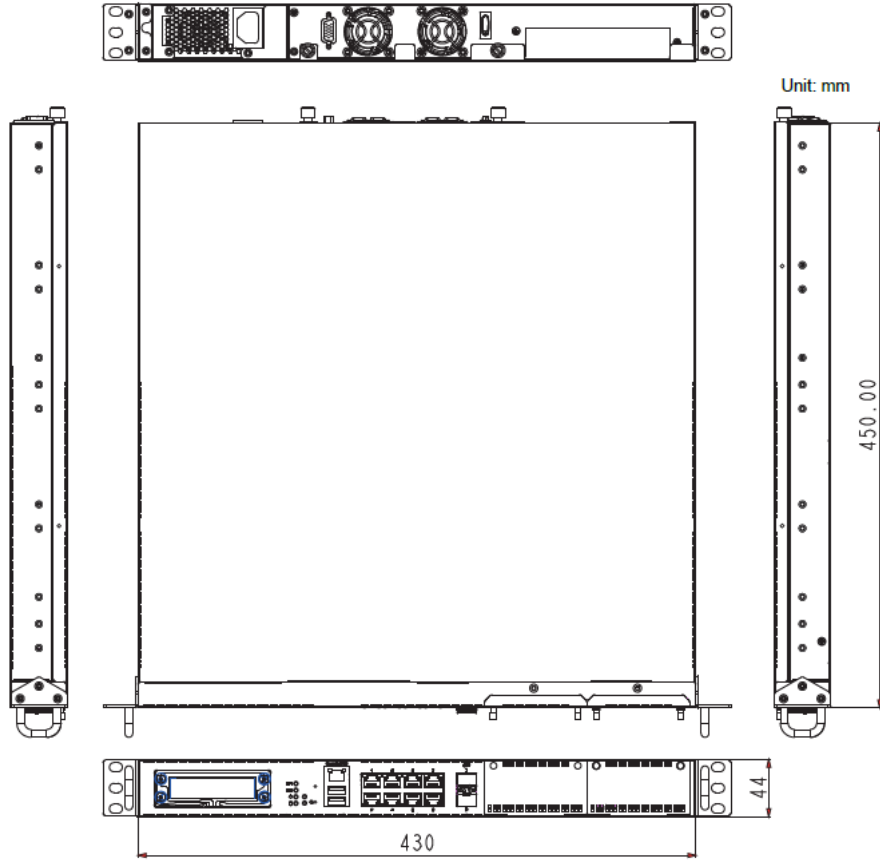

Default: 10 LAN ports max up to 26 LAN ports

1.5 I/O Outlets

Locate front and rear panel I/O outlets on the NA592 Series server to connect serial and ethernet interface devices.

1.5.1 Front Panel

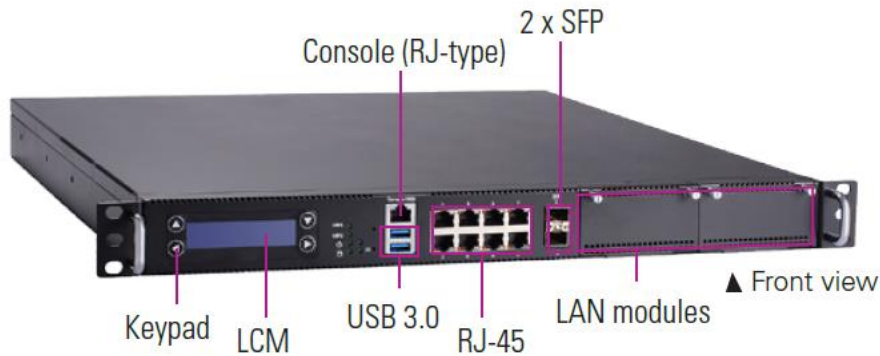

- **Power LED (Green)**
LED light up when the server is powered on to perform diagnostic tests and proper operation checking.
- **HDD LED (Green)**
LED flashes when HDD is transmitting or receiving data.
- **Programmable LED GPIO1, GPIO2 (Green)**
The GPIO1 and GPIO2 LEDs are controlled by programmable GPIO. A sample code will be provided that allow users to define their own function.
- **“Default” Tact Switch**
The sample code will be provided that allows users to define their own function. For example, when the system has any problems, this switch can support to reset it to the customer’s OS default settings if our customer’s OS supports this application.
- **“Reset” Tact Switch**
It is for reset the system to reboot your computer instead of turning OFF the power switch. It is a better way to reboot your system for a longer life of the system’s power supply.
- **Console Port**
This is a Cisco RJ-type connector console port for command line interface and diagnostic support by P.O.S.T (Power On Self Test).
- **USB3.0 Ports**
Two USB 3.0 ports supported.
- **LAN bypass LED(BP1/BP2)**
While running the LAN By-Pass function, the LED always lights up.

- **Transfer Rate for LAN port**

The double-color LED light indicates 10/100/1000Mbps transfer rate.

LED Light Color	Transfer Rate
Dark	10Mbps
Green	100Mbps
Orange	1000Mbps

- If the LED is dark and Active/Link LED is lighting on flashing, the transfer rate should be 10Mbps.
- When the green-color LED light is radiating, the transfer rate should be 100Mbps.
- When the orange-color LED light is radiating, the transfer rate should be 1000Mbps.
- When this LED and Link/Active LED both are dark, no networking devices are attached.

- **Active/Link LED for LAN Port**

- The orange LED is on when the LAN port connection is working.
- The LED flashes when transmitting or receiving any signals to or from the appliance.
- The LED is dark when the appliance is off.



Note: *Optional LAN module LED definition in Appendix C.*

1.5.2 Rear Panel



- **Power Supply**
System power use power cord to connect the power supply to electrical outlet (AC).
- **System Fans**
These are fans for cooling down system temperature.
- **VGA port**
This item is for optional, not include into BOM.

Section 2

Hardware and Installation

The NA592 Series are convenient for your various hardware configurations. This chapter will help you get familiar with the hardware.

2.1 Check List

The package bundled with your NA592 Series should contain the following items:

- **The NA592 Series network appliance hardware platform**
- **Power cord x 1**
- **Mounting brackets for rack installation (left/right) x 2**
- **Plastic stand for stack-up x 4**
- **Mounting screws for disk drive and additional screws for this appliance's spare parts**
- **SATA cable x 2 for 2.5" SATA HDDs**

If you cannot find this package or any items are missing, please contact Axiomtek distributors immediately. If you order any optional components, the package might contain those additional hardware or documents accordingly.

2.2 Board Layout

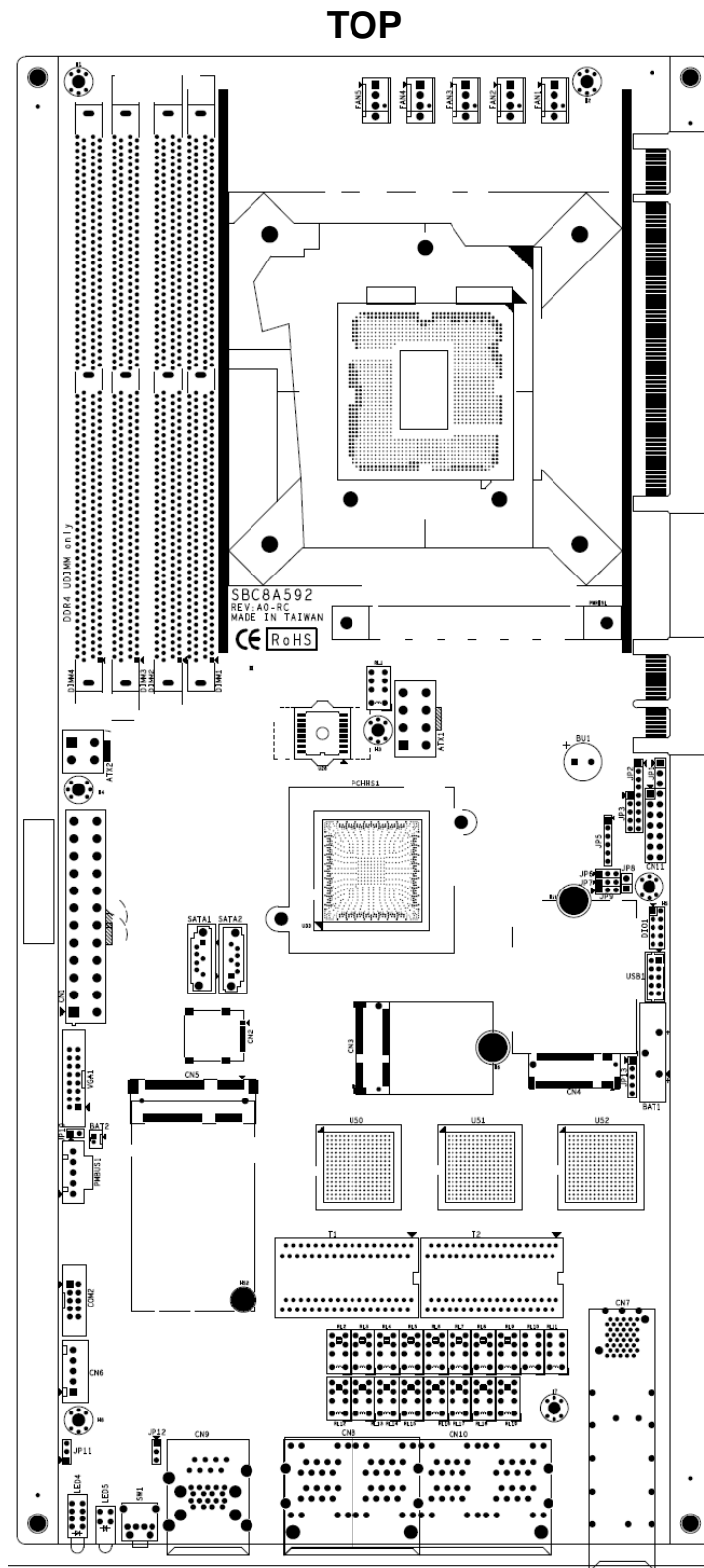

BOTTOM

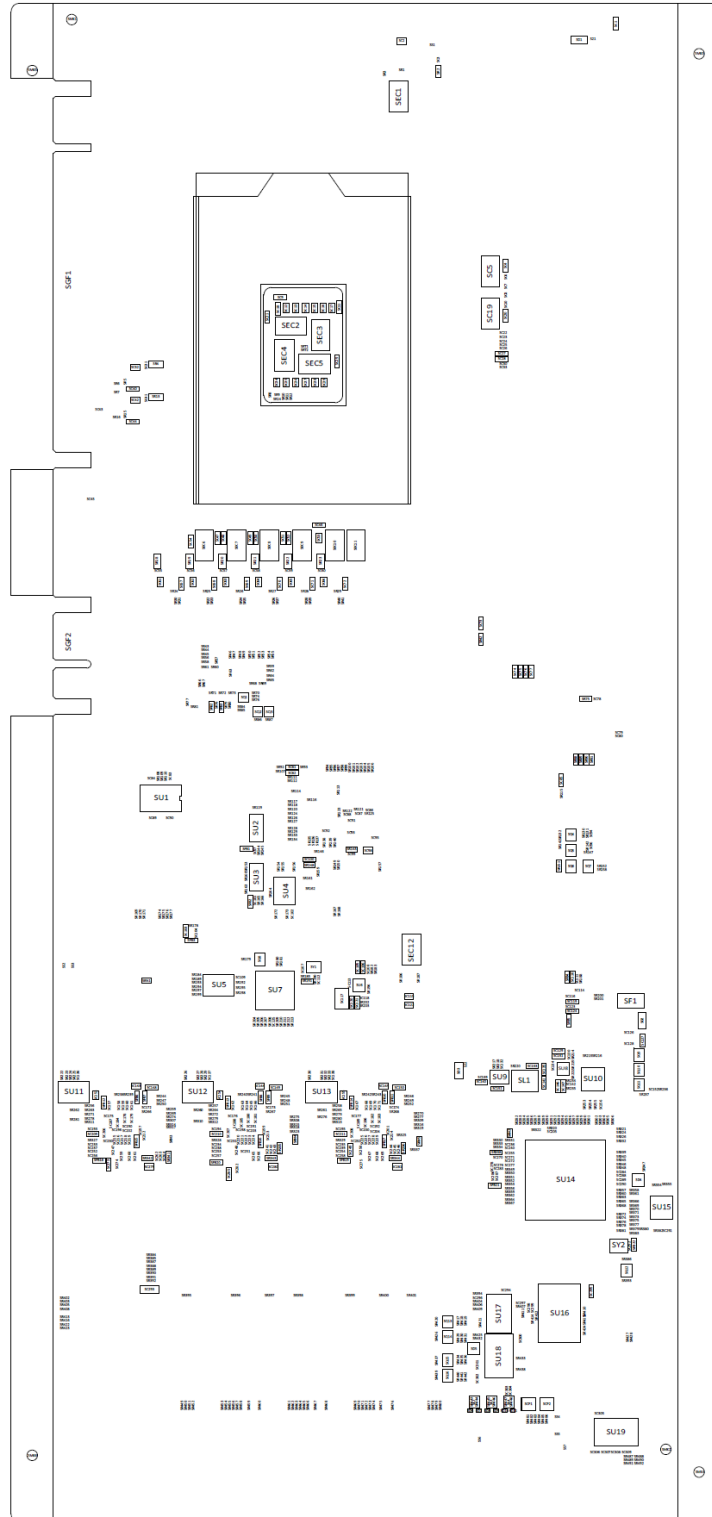

2.3 Jumper Settings

Jumper is a small component consists of jumper clip and jumper pins. Install jumper clip on 2 jumper pins to close. And remove jumper clip from 2 jumper pins to open. Below illustration shows how to set up jumper.

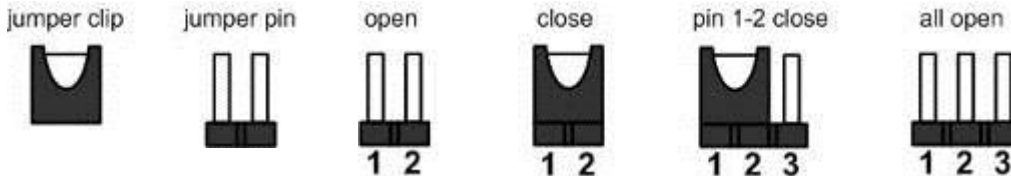



This section provides the information about jumpers and connectors of NA592 Series. Properly configure jumper settings on the main board in this appliance to meet your application purpose. Below we list a summary table of all jumpers and default settings for onboard devices.

Jumper	Definition	Jumper Setting
JP1	Clear CMOS Setting	1-2 : Normal (Default) 2-3 : Clear CMOS
JP2	LPC 80 port (Debug use)	LPC 80 port
JP3	TACT SW1 Selection	1-2 : Power button On/Off 2-3 : Reset (Default) 4-5 : GPI
JP5	CPLD FW debug use	debug use
JP6 JP7 JP9	LAN Bypass Trigger When Power On	(1-2)/(1-2)/(1-2) : Mother board/SEGN1 ~2 Bypass as same as Power Off status (1-2)/(1-2)/(2-3) : Mother board/SEGN1~2 Bypass Disable (Default) (1-2)/(2-3)/(2-3) : Mother board/SEGN1 ~2 Bypass Enable
JP8	Case open	1-2: Normal (Default) Open: case open
JP10	CRT always on	1-2: disable Open: CRT Always On (Default)
JP11	IPMI debug console	debug use
JP12	Auto Power Button Mode Selection	1-2 : Always Power on (Default in non-IPMI sku) 2-3 : Always Power off (Default in IPMI sku)
JP13	MCU FW debug use	debug use

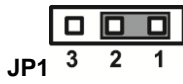
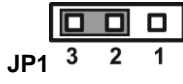
2.3.1 RTC/CMOS Clear Jumper (JP1)



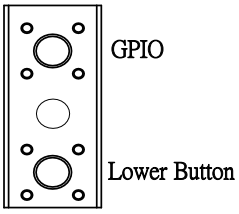
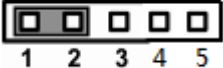
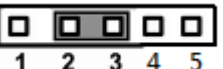



Description	Function	Jumper Setting
RTC/COMS Clear	Normal (Default)	
	Clear RTC/CMOS	

2.3.2 TACT SW1 Function Selection Jumper (JP3/Lower Button)

Description	Function	Jumper Setting
<p>TACT SW1 Function Selection</p> 	Power On/Off	<p>JP3</p> 
	Reset (Default)	<p>JP3</p> 
	GPI	<p>JP3</p> 

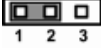
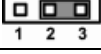

2.3.3 LAN Bypass Control Jumper (JP6/JP7/JP9)

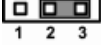
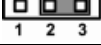
Use this jumper to select the LAN Bypass Function.



Description	Function	Jumper Setting
LAN Bypass Trigger when Power On	All SEG. Bypass as same as Power Off status	<p>JP6  1 2 3</p> <p>JP7  1 2 3</p> <p>JP9  1 2 3</p>
	All SEG Bypass Disable (Default)	<p>JP6  1 2 3</p> <p>JP7  1 2 3</p> <p>JP9  1 2 3</p>
	All SEG Bypass Enable	<p>JP6  1 2 3</p> <p>JP7  1 2 3</p> <p>JP9  1 2 3</p>

2.3.4 Case open (JP8)

The 2-Pin Case open connector is for chassis with a sensor. When the case is opened, the buzzer will be sounded. This function default is disable. Please enable case open warning in the BIOS menu.

Description	Function	Jumper Setting
Case open	Normal (Default)	<p> 1 2 JP8</p>
	Case open	<p> 1 2 JP8</p>

2.3.5 CRT always on (JP10)

Description	Function	Jumper Setting
CRT always on	CRT Always On disable	 1 2 JP10
	CRT Always On enable (Default)	 1 2 JP10

2.3.6 Auto Power Button Model Jumper (JP12)

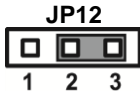
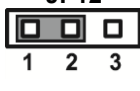
Description	Function	Jumper Setting
Auto Power Button Mode Selection	Always Power off (Default in IPMI sku)	 JP12 1 2 3
	Always Power on (Default in non-IPMI sku)	 JP12 1 2 3

2.4 Connectors

Signals go to other parts of the system through connectors. Loose or improper connection might cause problems, please make sure all connectors are properly and firmly connected. Here is a summary table which shows all connectors on the hardware.

Connectors	Label
ATX 2*4 pin +12V CPU Power Connector	ATX1
ATX 2*2 pin +12V Power Connector	ATX2
RTC coin battery Connector	BAT1
Serial Port2 Connector	COM2
ATX 24 pin Power Connector	CN1
Nano SIM card slot	CN2
M.2 E-key 2230 (PCIeX1 & USB2.0 signal)	CN3
M.2 B-key 2242 (SATA & USB2.0)	CN4
Mini PCIe full connector (PCIeX1/SATA, USB2.0, SIM signal)	CN5
LCM connector	CN6
1X2 SFP(1G) Connector	CN7
USB3.0 and console Connector	CN9
2X4 RJ45 Connector	CN10
Front Panel Bezel Connector	CN11
DDR4 DIMM Socket (Channel A DIMM0)	DIMM1
DDR4 DIMM Socket (Channel A DIMM1)	DIMM2
DDR4 DIMM Socket (Channel B DIMM0)	DIMM3
DDR4 DIMM Socket (Channel B DIMM1)	DIMM4
Digital input/output Connector	DIO1
System FAN	FAN1~3
Serial ATA Connector	SATA1~2
USB2.0 Port Connector	USB1
VGA pin header	VGA1

2.4.1 ATX 2*4 pin +12V CPU Power Connector (ATX1)

+12V power supplied to CPU on the board by connecting the power connector. Please make sure all components and devices are properly installed before connecting the power connector. We recommend connecting both ATX1 and ATX2 to board at the same time to adequately provide power.

Pin	Signal	Pin	Signal
1	Ground (GND)	2	Ground (GND)
3	Ground (GND)	4	Ground (GND)
5	+12V	6	+12V
7	+12V	8	+12V

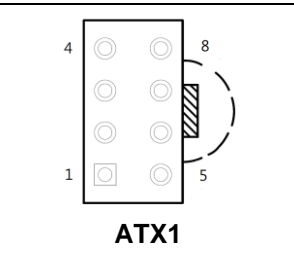

ATX1

2.4.2 ATX 2*2 pin +12V Power Connector (ATX2)

+12V power supplied to CPU on the board by connecting the power connector. Please make sure all components and devices are properly installed before connecting the power connector. We recommend connecting both ATX1 and ATX2 to board at the same time to adequately provide power.

Pin	Signal	Pin	Signal
1	Ground (GND)	2	Ground (GND)
3	+12V	4	+12V

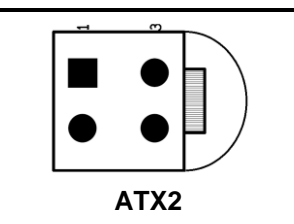

ATX2

2.4.3 Serial Port2 Connector (COM2) Co-lay CN6

Pin	Signal	Pin	Signal
1	Data Carrier Detect (DCD)	2	Data Set Ready (DSR)
3	Receive Date (RXD)	4	Request to Send (RTS)
5	Transmit Data (TXD)	6	Clear to Send (CTS)
7	Data Terminal Ready (DTR)	8	Ring Indicator (RI)
9	Ground (GND)	10	NC

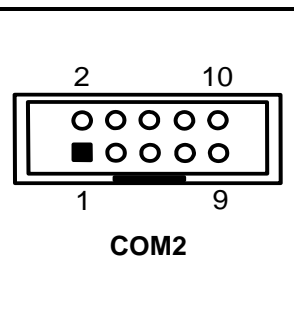

COM2

2.4.4 ATX 24 pin Power Connector (CN1)

Steady and sufficient power can be supplied to all components on the board by connecting the power connector. Please make sure all components and devices are properly installed before connecting the power connector.

Pin	Signal	Pin	Signal
1	+3.3V	2	+3.3V
3	Ground (GND)	4	+5V
5	Ground (GND)	6	+5V
7	Ground (GND)	8	PWR_OK
9	5VSB	10	+12V
11	+12V	12	+3.3V
13	+3.3V	14	-12V
15	Ground (GND)	16	PS_ON
17	Ground (GND)	18	Ground (GND)
19	Ground (GND)	20	-5V
21	+5V	22	+5V
23	+5V	24	Ground (GND)

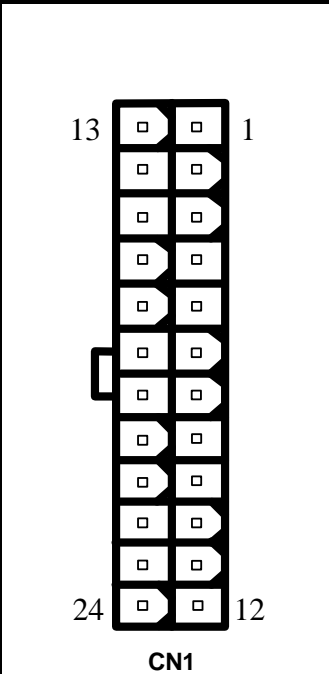

2.4.5 Nano SIM card slot (CN2)

Pin	Signal
1	SIM_PWR
2	SIM_REST
3	SIM_CLK
5	Ground (GND)
6	SIM_VPP
7	SIM_DATA

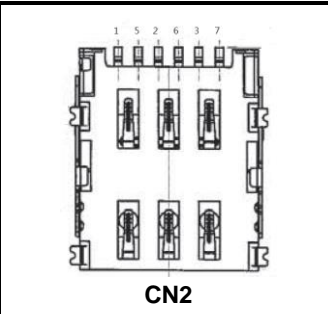

2.4.6 M.2 E-key 2230 (CN3)

Pin	Signal	Pin	Signal
1	Ground (GND)	2	+3.3V
3	USB_D+	4	+3.3V
5	USB_D-	6	NC
7	Ground (GND)	8	NC
9	NC	10	NC
11	NC	12	NC
13	Ground (GND)	14	NC
15	NC	16	NC
17	NC	18	Ground (GND)
19	Ground (GND)	20	Wake_N
21	NC	22	NC
M.2 E-Key			
33	Ground (GND)	32	NC
35	PCIE_TX_P	34	NC
37	PCIE_TX_N	36	NC
39	Ground (GND)	38	NC
41	PCIE_RX_P	40	NC
43	PCIE_RX_N	42	NC
45	Ground (GND)	44	NC
47	PCIE_CLK_P	46	NC
49	PCIE_CLK_N	48	NC
51	Ground (GND)	50	SUS_CLK
53	NC	52	PLTRST_N
55	Wake_N	54	NC
57	Ground (GND)	56	NC
59	NC	58	SMBDAT
61	NC	60	SMBCLK
63	Ground (GND)	62	+3.3V
65	NC	64	+3.3V
67	NC	66	+3.3V
69	Ground (GND)	68	NC
71	NC	70	NC
73	NC	72	+3.3V
75	Ground (GND)	74	NC

2.4.7 M.2 B-key 2242 (CN4)

Pin	Signal	Pin	Signal
1	NC	2	+3.3V
3	Ground (GND)	4	+3.3V
5	Ground (GND)	6	NC
7	USB_D+	8	NC
9	USB_D-	10	SATA_LED
11	Ground (GND)		
M.2 B-Key			
21	NC	20	NC
23	NC	22	NC
25	NC	24	NC
27	Ground (GND)	26	NC
29	NC	28	NC
31	NC	30	NC
33	Ground (GND)	32	NC
35	NC	34	NC
37	NC	36	NC
39	Ground (GND)	38	NC
41	SATA_RX_P	40	SMBCLK
43	SATA_RX_N	42	SMBDAT
45	Ground (GND)	44	NC
47	SATA_TX_N	46	NC
49	SATA_TX_P	48	NC
51	Ground (GND)	50	PLTRST_N
53	NC	52	NC
55	NC	54	NC
57	Ground (GND)	56	NC
59	NC	58	NC
61	NC	60	NC
63	NC	62	NC
65	NC	64	NC
67	NC	66	NC
69	NC	68	SUS_CLK
71	Ground (GND)	70	+3.3V
73	Ground (GND)	72	+3.3V
75	NC	74	+3.3V

2.4.8 Mini Card Connector (CN5)

This is a 52-pin connector which has two sku. One is PCIeX1 and USB2.0. Another is SATA and USB2.0. The sku is fixed and cannot be changed after shipment.

Pin	Signal	Pin	Signal
1	WAKE_N	2	+3.3
3	NC	4	Ground (GND)
5	NC	6	+1.5V
7	NC	8	SIM_PWR
9	Ground (GND)	10	SIM_DATA
11	PCIE_CLK_N	12	SIM_CLK
13	PCIE_CLK_P	14	SIM_RESET
15	Ground (GND)	16	SIM_VPP
17	NC	18	Ground (GND)
19	NC	20	+3.3V
21	Ground (GND)	22	PLTRST_N
23	PCIE_RX_DN (SATA_RX_DP, Optional)	24	+3.3V
25	PCIE_RX_DP (SATA_RX_DN, Optional)	26	Ground (GND)
27	Ground (GND)	28	+1.5V
29	Ground (GND)	30	SMBCLK
31	PCIE_TX_DN (SATA_TX_DN, Optional)	32	SMBDAT
33	PCIE_TX_DP (SATA_TX_DP, Optional)	34	Ground (GND)
35	Ground (GND)	36	USB_D-
37	Ground (GND)	38	USB_D+
39	+3.3V	40	Ground (GND)
41	+3.3V	42	NC
43	Ground (GND)	44	NC
45	NC	46	NC
47	NC	48	+1.5V
49	NC	50	Ground (GND)

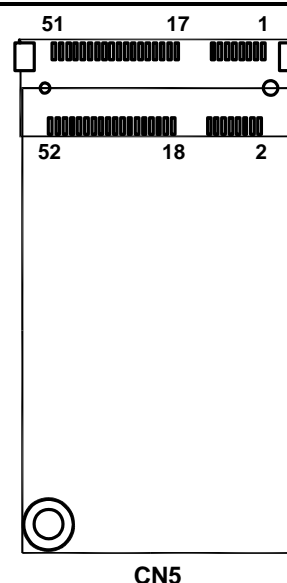

51	NC	52	+3.3V	
----	----	----	-------	--

2.4.9 LCM Connector (CN6)

This is a 5-pin connector for LCM.

Pin	Signal
1	+5V
2	RX (co-lay COM2)
3	NC
4	TX (co-lay COM2)
5	Ground (GND)



CN6

2.4.10 1X2 SFP Connector (CN7)

Pin	Signal	Pin	Signal
T1	Ground (GND)	L1	Ground (GND)
T2	TX_Fault	L2	TX_Fault
T3	TX_Disable	L3	TX_Disable
T4	SDA	L4	SDA
T5	SCL	L5	SCL
T6	MOD_ABS	L6	MOD_ABS
T7	RS0	L7	RS0
T8	RX_LOS	L8	RX_LOS
T9	Ground (GND)	L9	Ground (GND)
T10	Ground (GND)	L10	Ground (GND)
T11	Ground (GND)	L11	Ground (GND)
T12	RD-	L12	RD-
T13	RD+	L13	RD+
T14	Ground (GND)	L14	Ground (GND)
T15	VCCR (+3.3V Level)	L15	VCCR (+3.3V Level)
T16	VCCT (+3.3V Level)	L16	VCCT (+3.3V Level)
T17	Ground (GND)	L17	Ground (GND)
T18	TD+	L18	TD+
T19	TD-	L19	TD-
T20	Ground (GND)	L20	Ground (GND)
A	Down Fiber Port: Active		
B	Up Fiber Port: Active		

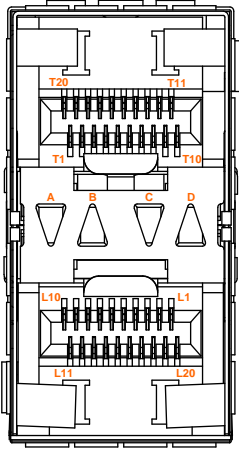

CN7

C	Down Fiber Port: Link	
D	Up Fiber Port: Link	

2.4.11 USB3.0 and console Connector (CN9)

Pin	Signal	Pin	Signal
1	USB_POWER	2	USBP2N
3	USBP2P	4	Ground (GND)
5	SSRX2N	6	SSRX2P
7	Ground (GND)	8	SSTX2N
9	SSTX2P	10	USB_POWER
11	USBP1N	12	USBP1P
13	Ground (GND)	14	SSRX1N
15	SSRX1P	16	Ground (GND)
17	SSTX1N	18	SSTX1P
19	RTS	20	DTR
21	TX	22	Ground (GND)
23	Ground (GND)	24	RX
25	DSR	26	CTS

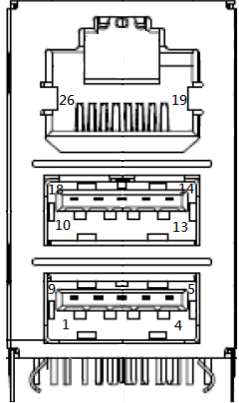

CN9

2.4.12 2*4 RJ45 Connector (CN10)

Pin	Signal	Pin	Signal
1	MDI0+	5	MDI2-
2	MDI0-	6	MDI1-
3	MDI1+	7	MDI3+
4	MDI2+	8	MDI3-
A	100 LAN LED (Green)/ 1000 LAN LED (Amber)		
B	Active LED (Orange)		

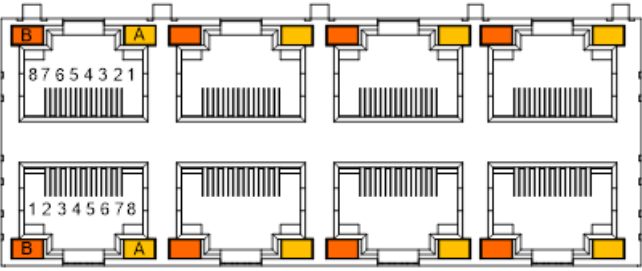

CN10

2.4.13 Front Panel Bezel Connector (CN11)

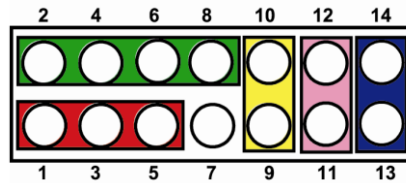

Power LED :

This 3-pin connector (Pin 1, 3, 5) connects a LED indicator to the system power switch on the case. Pin 1 is assigned as +, and Pin 3, Pin 5 as -. The Power LED lights up when the system is powered ON.

External Speaker and Internal Buzzer Connector :

This 4-pin connector (Pin 2, 4, 6, 8) can be connected to the case-mounted speaker unit or internal buzzer. While connecting the CPU card to an internal buzzer, please short pins 2-4; while connecting to an external speaker, you need to set pins 2-4 to Open and connect the speaker cable to pin 8 (+) and pin 2 (-).

ATX Power On/Off Button :

This 2-pin connector (Pin 9, 10) connects the front panel's ATX power button to the CPU card, which allows users to control ATX power supply to be power on/off.

System Reset Switch :

This 2-pin connector (Pin 11, 12) can be connected to the case-mounted reset switch that reboots your computer instead of turning OFF the power switch. It is a better way to reboot your system for a longer life of the system's power supply.

HDD Activity LED :

This connection is linked to hard drive activity LED on the control panel. LED flashes when HDD is being accessed. The 2-pin connector (Pin 13, 14) connects the hard disk drive to the front panel HDD LED, Pin 13 assigned as -, and Pin 14 as +.

2.4.14 Digital input/output Connector (DIO1)

Pin	Signal	Pin	Signal
1	Ground (GND)	2	Ground (GND)
3	GPO3	4	GPI3
5	GPO2	6	GPI2
7	GPO1	8	GPI1
9	GPO0	10	GPI0

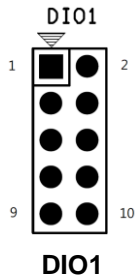

2.4.15 FAN Connectors (FAN1~FAN3)

System fans are always needed to cool down CPU and system temperature. FAN1~FAN3 connectors provide power to these system fan.

Pin	Signal
1	Ground (GND)
2	+12V
3	Rotation Detection In
4	PWM signal

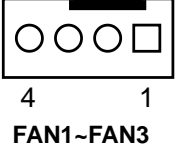

2.4.16 Serial ATA Connectors (SATA1 & SATA2)

These Serial Advanced Technology Attachment (SATA) connectors are for high-speed SATA interface ports. They are computer bus interfaces for connecting to devices such as serial ATA hard disk drives. Each SATA connector supports a single SATA device.

Pin	Signal	Pin	Signal
1	Ground (GND)	2	TX+
3	TX-	4	Ground (GND)
5	RX-	6	RX+
7	Ground (GND)		



2.4.17 USB2.0 Port Connector (USB1)

The 10-pin standard Universal Serial Bus 2.0(USB2.0) connector on this board is for installing versatile USB interface peripherals.

Pin	Signal	Pin	Signal
1	USB_POWER	2	USB_POWER
3	USB_P1_DN	4	USB_P2_DN
5	USB_P1_DP	6	USB_P2_DP
7	Ground (GND)	8	Ground (GND)
9	Ground (GND)	10	Ground (GND)

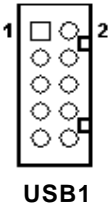

2.4.18 VGA pin header (VGA1)

Pin	Signal	Pin	Signal
1	RED	2	NC
3	GREEN	4	NC
5	BLUE	6	Ground (GND)
7	VCC (+5V Level)	8	DDC DATA
9	Ground (GND)	10	Ground (GND)
11	Ground (GND)	12	Horizontal Sync
13	Ground (GND)	14	Vertical Sync
15	DDC CLK	16	NC

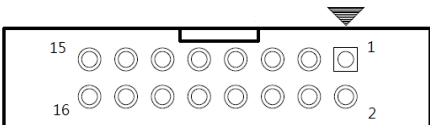

2.5 Hardware Installation

This section provides information of how to install the NA592 Series.

2.5.1 Installing the CPU

Before installing the processor, please access Intel® website for more detail information of Processor Integration Video (LGA1200):

<https://www.intel.sg/content/www/xa/en/support/products/873/processors.html>

The LGA1200 processor socket comes with a cover to protect the processor. Please install the processor into the CPU socket step by step as below:

- Press the load lever to release the load plate, which covers the CPU socket, from its locking position.
- Gently lift the load lever to open the load plate. Remove the plastic cap.

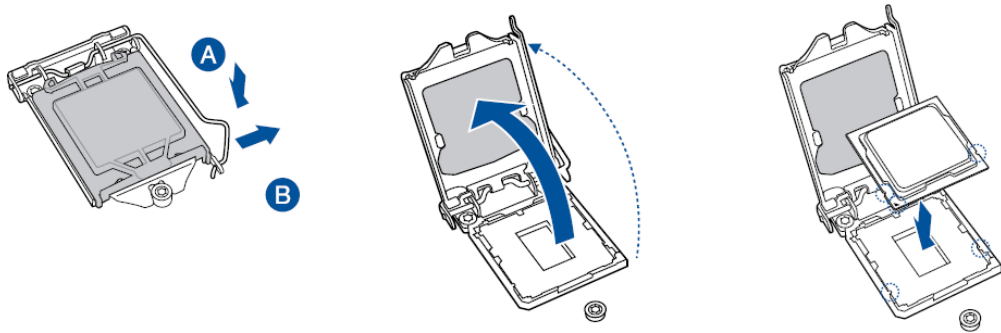

- Use your thumb and your index finger to hold the CPU at the North center edge and the South center edge of the CPU.
- Align the small triangle marker on the CPU to its corresponding triangle marker on the load bracket. Once it is aligned, carefully lower the CPU straight down into the socket. (Do not drop the CPU on the socket or move it horizontally or vertically.)
- Do not rub the CPU against the surface or against any pins of the socket to avoid damaging the CPU or the socket.
- With the CPU inside the socket, inspect the four corners of the CPU to make sure that the CPU is properly installed.
- Use your thumb to gently push the load lever down to the lever lock.
-

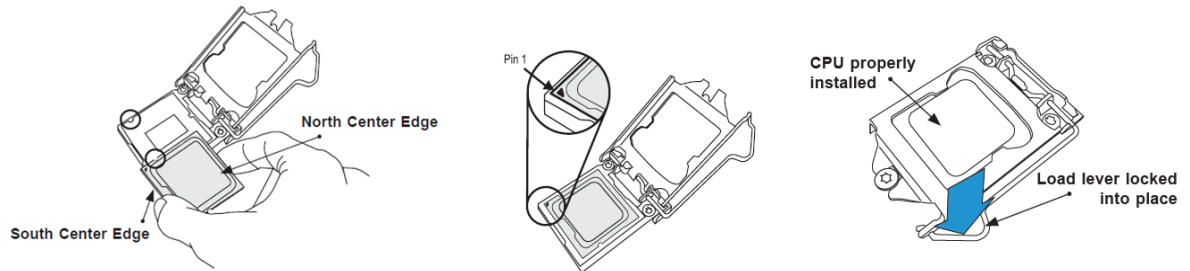

2.5.2 Installing the Memory

The board supports four DDR4 UDIMM memory sockets with maximum memory capacity up to 128GB.

Please follow steps below to install the memory modules:

1. Push down latches on each side of the DIMM socket.
2. Align the memory module with the socket that notches of memory module must match the socket keys for a correct installation.
3. Install the memory module into the socket and push it firmly down until it is fully seated. The socket latches are levered upwards and clipped on to the edges of the DIMM.
4. Install any remaining DIMM modules.

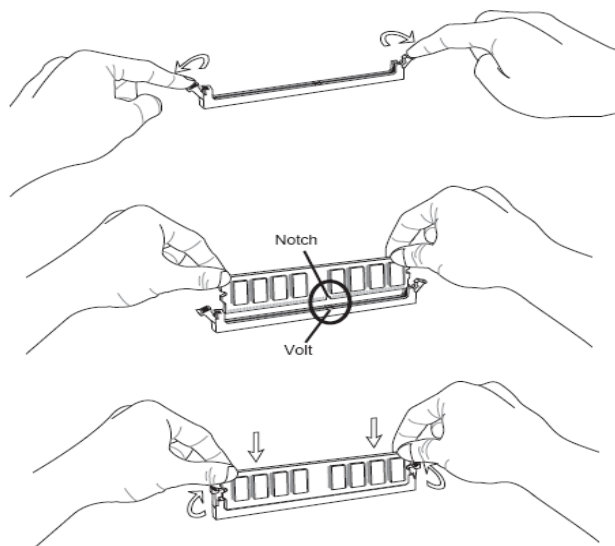

2.5.3 Installing the Hard Disks

The system supports or two 2.5" HDDs or one 3.5" HDD.

- Two 2.5" HDD

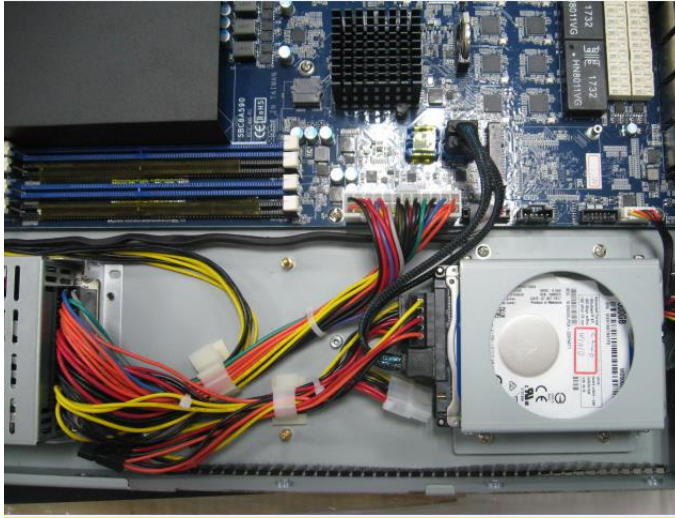

- One 3.5" HDD



This page is intentionally left blank.

Section 3

AMI BIOS Setup Utility

The AMI BIOS provides users with a built-in setup program to modify basic system configuration. All configured parameters are stored in a battery-backed-up RAM (CMOS RAM) to save the setup information whenever the power is turned off. This chapter provides users with detailed description about how to set up basic system configuration through the AMI BIOS setup utility.

3.1 Starting

To enter the setup screens, follow the steps below:

1. Turn on the computer and press the or<ESC> key immediately.
2. After you press the or<ESC> key, the main BIOS setup menu displays. You can access the other setup screens from the main BIOS setup menu, such as the Advanced and Chipset menus.

It is strongly recommended that you should avoid changing the chipset's defaults. Both AMI and your system manufacturer have carefully set up these defaults that provide the best performance and reliability.

3.2 Navigation Keys

The BIOS setup/utility uses a key-based navigation system called hot keys. Most of the BIOS setup utility hot keys can be used at any time during the setup navigation process. These keys include <F1>, <F2>, <Enter>, <ESC>, <Arrow> keys, and so on.



Note: *Some of the navigation keys differ from one screen to another.*

Hot Keys	Description
→← Left/Right	The Left and Right <Arrow> keys allow you to select a setup screen.
↑↓ Up/Down	The Up and Down <Arrow> keys allow you to select a setup screen or sub-screen.
+– Plus/Minus	The Plus and Minus <Arrow> keys allow you to change the field value of a particular setup item.
Tab	The <Tab> key allows you to select setup fields.
F1	The <F1> key allows you to display the general help screen.
F2	The <F2> key allows you to load previous values.
F3	The <F3> key allows you to load optimized defaults.
F4	The <F4> key allows you to save any changes you have made and exit setup. Press the <F4> key to save your changes.
Esc	The <Esc> key allows you to discard any changes you have made and exit the setup. Press the <Esc> key to exit the setup without saving your changes.
Enter	The <Enter> key allows you to display or change the setup option listed for a particular setup item. The <Enter> key can also allow you to display the setup sub- screens.

3.3 Main Menu

When you first enter the setup utility, you will enter the Main setup screen. You can always return to the Main setup screen by selecting the Main tab. System Time/Date can be set up as described below. The Main BIOS setup screen is shown below.

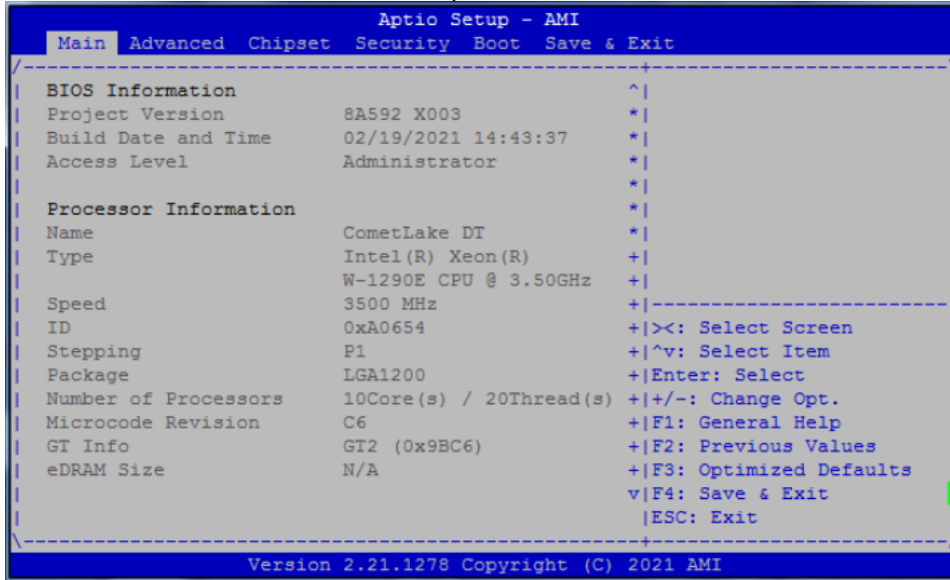

System Date/Time

Use this option to change the system time and date. Highlight System Time or System Date using the <Arrow> keys. Enter new values through the keyboard. Press the <Tab> key or the <Arrow> keys to move between fields. The date must be entered in MM/DD/YY format. The time is entered in HH:MM:SS format.

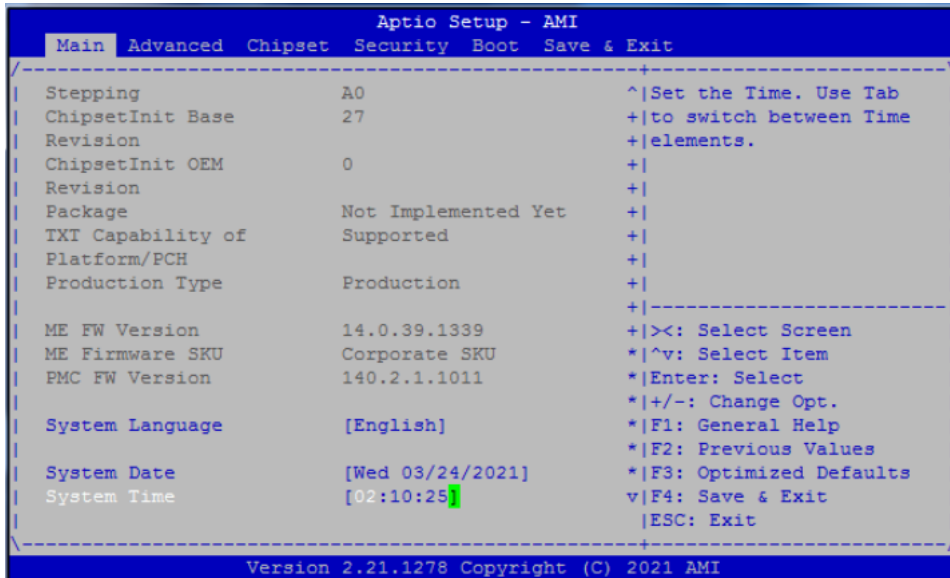

3.4 Advanced Menu

The Advanced menu also allows users to set configuration of the CPU and other system devices. You can select any of the items in the left frame of the screen to go to the sub menus:

```

                             Aptio Setup - AMI
  Main  Advanced  Chipset  Security  Boot  Save & Exit
-----|-----
|> CPU Configuration          |CPU Configuration
|> PCH-FW Configuration      |Parameters
|> Trusted Computing         |
|> NCT6102D Super IO Configuration
|> NCT6102D HW Monitor      |
|> Serial Port Console Redirection
|> USB Configuration        |
|> Network Stack Configuration
|> NVMe Configuration       |
|                             |-----|
|                             |><: Select Screen
|                             |^v: Select Item
|                             |Enter: Select
|                             |+/-: Change Opt.
|                             |F1: General Help
|                             |F2: Previous Values
|                             |F3: Optimized Defaults
|                             |F4: Save & Exit
|                             |ESC: Exit
-----|-----
                             Version 2.21.1278 Copyright (C) 2021 AMI

```

- ▶ CPU Configuration
- ▶ PCH-FW Configuration
- ▶ Trusted Computing
- ▶ NCT6102D Super IO Configuration
- ▶ NCT6102D HW Monitor
- ▶ Serial Port Console Redirection
- ▶ USB Configuration
- ▶ Network Stack Configuration
- ▶ NVMe Configuration

For items marked with “▶”, please press <Enter> for more options.

- CPU Configuration

This screen shows the CPU Configuration, and you can change the value of the selected option.

```
Aptio Setup - AMI
Main  Advanced  Chipset  Security  Boot  Save & Exit
-----
|> CPU Configuration          | CPU Configuration
|> PCH-FW Configuration      | Parameters
|> Trusted Computing         |
|> NCT6102D Super IO Configuration |
|> NCT6102D HW Monitor      |
|> Serial Port Console Redirection |
|> USB Configuration        |
|> Network Stack Configuration |
|> NVMe Configuration       |
|                             |
|                             |
|                             |
|                             |
|                             |
|><: Select Screen
|^v: Select Item
|Enter: Select
|+/-: Change Opt.
|F1: General Help
|F2: Previous Values
|F3: Optimized Defaults
|F4: Save & Exit
|ESC: Exit
-----
Version 2.21.1278 Copyright (C) 2021 AMI
```

```
Aptio Setup - AMI
Advanced
-----
| CPU Configuration          |
| Type                      | Intel(R) Xeon(R)
|                           | W-1290E CPU @ 3.50GHz
| ID                        | 0xA0654
| Speed                     | 3500 MHz
| L1 Data Cache             | 32 KB x 10
| L1 Instruction Cache      | 32 KB x 10
| L2 Cache                  | 256 KB x 10
| L3 Cache                  | 20 MB
| L4 Cache                  | N/A
| VMX                       | Supported
| SMX/TXT                   | Supported
|                             |
|                             |
|                             |
|><: Select Screen
|^v: Select Item
|Enter: Select
|+/-: Change Opt.
|F1: General Help
|F2: Previous Values
|F3: Optimized Defaults
|F4: Save & Exit
|ESC: Exit
-----
Version 2.21.1278 Copyright (C) 2021 AMI
```

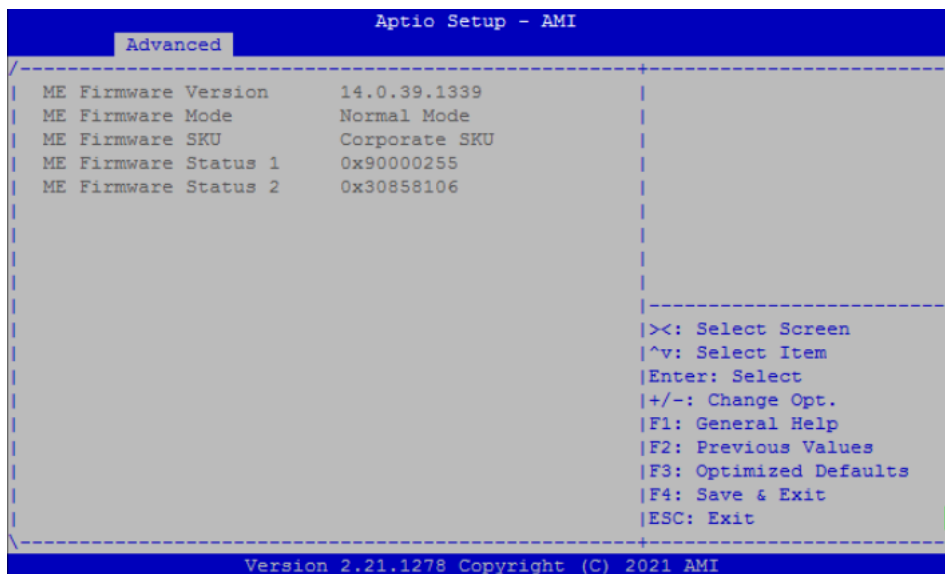
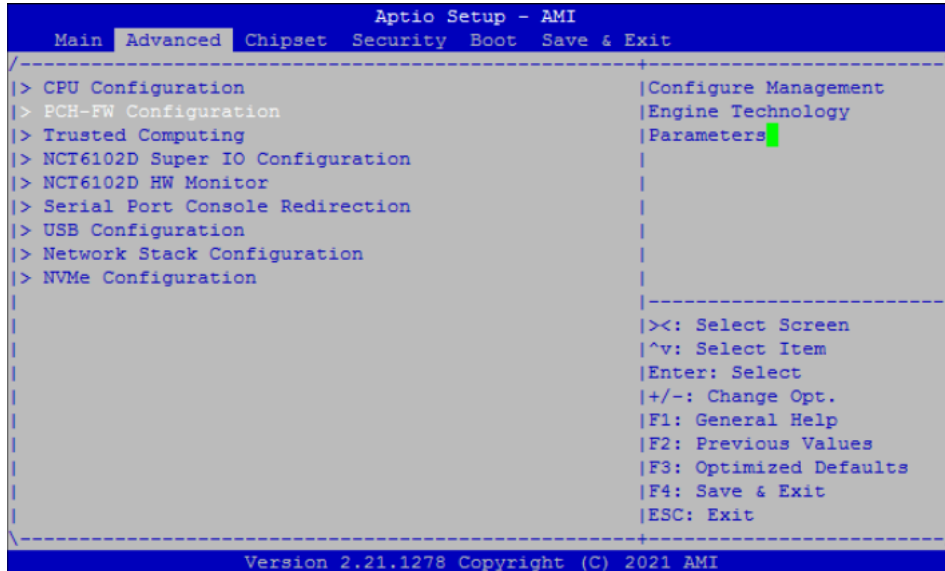

● **PCH-FW Configuration**

You can use this screen to select options for the PCH-FW Configuration, and change the value of the selected option. A description of the selected item appears on the right side of the screen. For items marked with “▶”, please press <Enter> for more options.

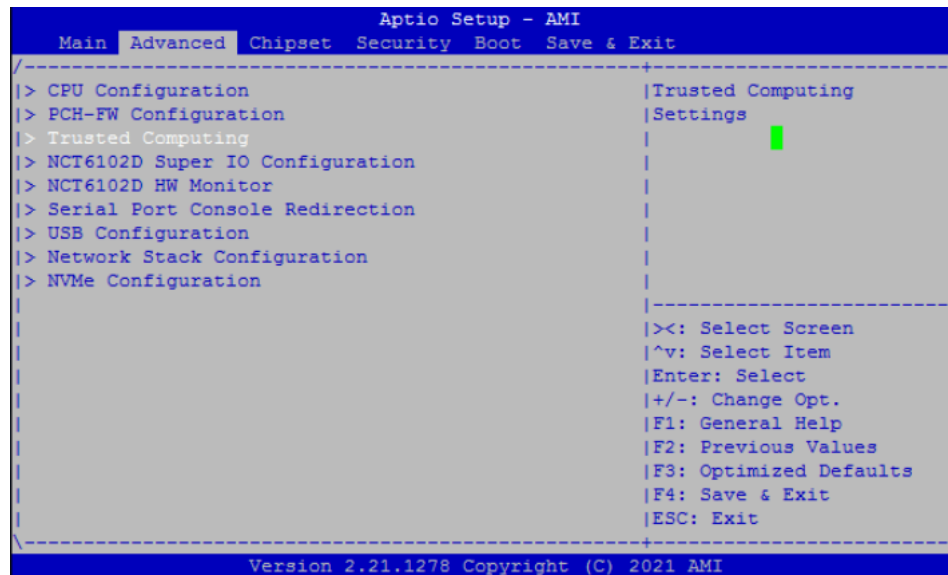

- **Trusted Computing**

This item supports security devices. “Enable” or “Disable” BIOS support for security devices.



If you installed the Security device, such as TPM, you could see the following information for the TPM device and status.

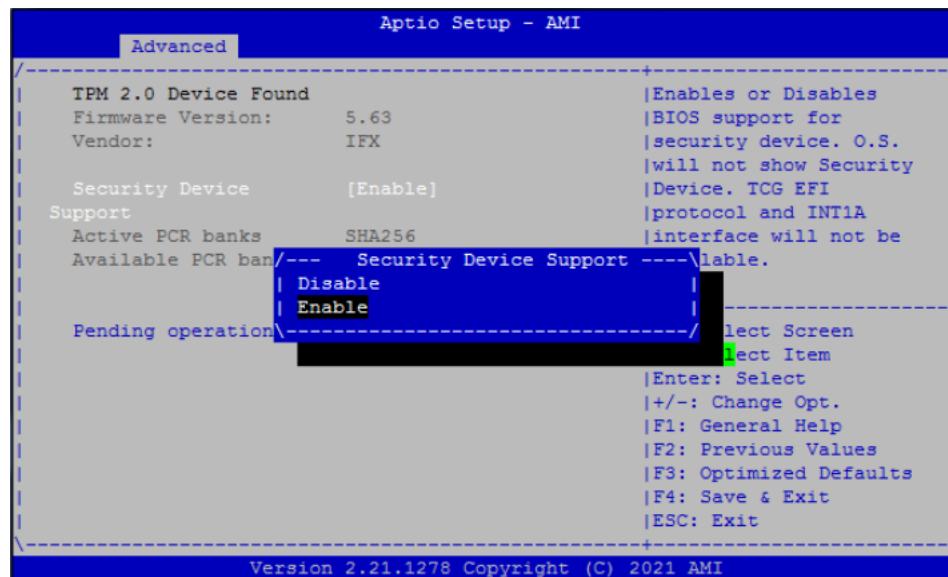

- **NCT6102D Super IO Configuration**

You can use this screen to select options for the NCT6102D Super IO Configuration, and change the value of the selected option. A description of the selected item appears on the right side of the screen. For items marked with “▶”, please press <Enter> for more options.

```

Aptio Setup - AMI
Main  Advanced  Chipset  Security  Boot  Save & Exit
-----
|> CPU Configuration                |System Super IO Chip
|> PCH-FW Configuration            |Parameters.
|> Trusted Computing
|> NCT6102D Super IO Configuration  |
|> NCT6102D HW Monitor
|> Serial Port Console Redirection
|> USB Configuration
|> Network Stack Configuration
|> NVMe Configuration
|
|-----|
|>: Select Screen
|^v: Select Item
|Enter: Select
|+/-: Change Opt.
|F1: General Help
|F2: Previous Values
|F3: Optimized Defaults
|F4: Save & Exit
|ESC: Exit
|-----|
Version 2.21.1278 Copyright (C) 2021 AMI

```

- **Serial Port 1 Configuration**

This option specifies the base I/O port address and Interrupt Request address of serial port 1. The Optimal setting is 3F8h/IRQ4.

```

Aptio Setup - AMI
Advanced
-----
| NCT6102D Super IO Configuration |Set Parameters of
| Super IO Chip NCT6102D          |Serial Port 1 (COMA)
|> Serial Port 1 Configuration
|> Serial Port 2 Configuration
|
| Chassis Opened Warning [Disabled]
| Chassis Opened status [Disabled]
|
| LBP@PowerOn(All SEG) [Disable]
| LBP@PowerOff(All SEG) [Enable]
|
|-----|
|>: Select Screen
|^v: Select Item
|Enter: Select
|+/-: Change Opt.
|F1: General Help
|F2: Previous Values
|F3: Optimized Defaults
|F4: Save & Exit
|ESC: Exit
|-----|
Version 2.21.1278 Copyright (C) 2021 AMI

```

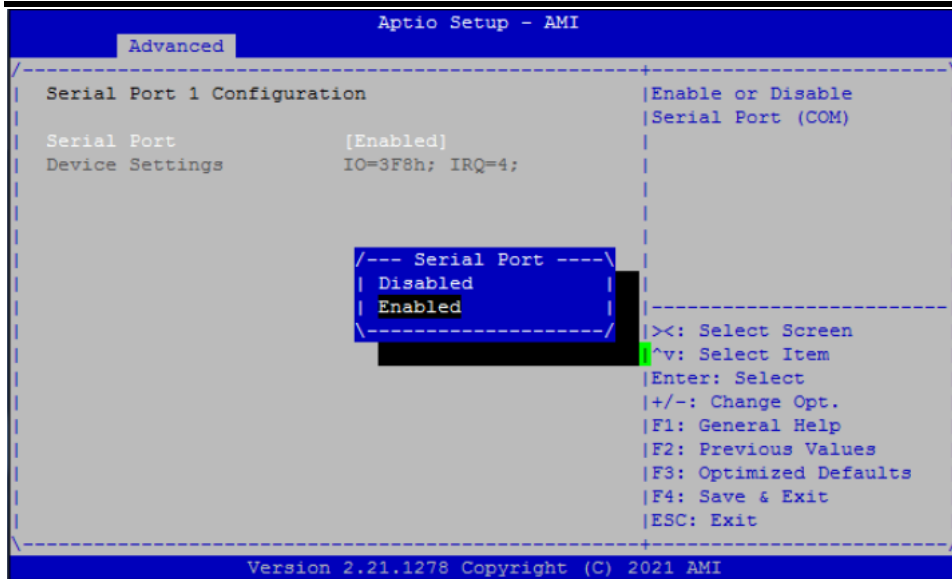

➤ **Serial Port 2 Configuration**

This option specifies the base I/O port address and Interrupt Request address of serial port 2. The Optimal setting is 2F8h/IRQ3.

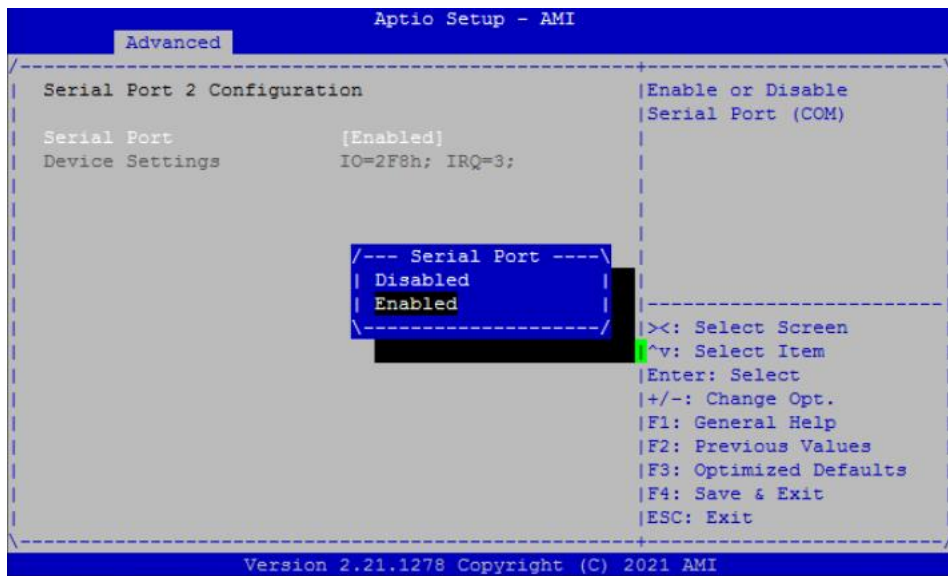
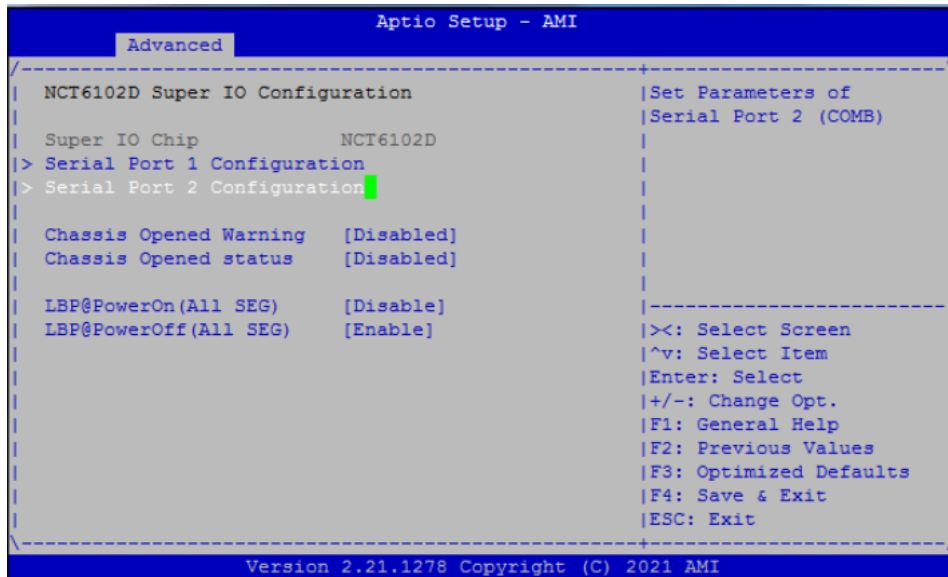

- **NCT6102D H/W Monitor**

This screen monitors are hardware health.

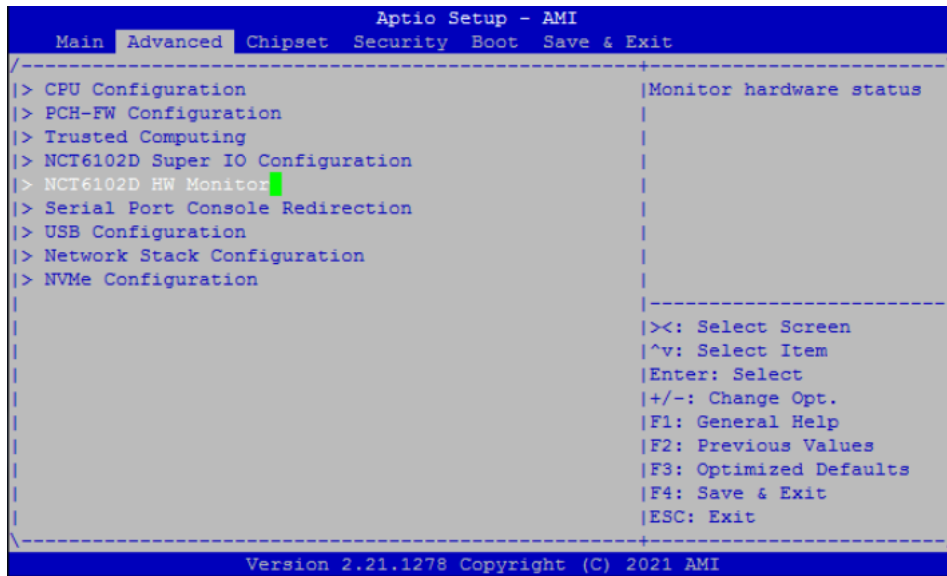

This screen displays the temperature of system and CPU, cooling fan speed in RPM and system voltages (V CORE, +5VSBV and +5V).

```
Aptio Setup - AMI
Advanced
-----
Pc Health Status
SYS_TEMP           : +39 C
CPU_TEMP           : +36 C
SYS Fan/Fan1       : 7627 RPM
CPU Fan/Fan2       : 7627 RPM
AUX Fan/Fan3       : N/A
V CORE             : +1.040 V
+5VSB              : +5.056 V
VBAT               : +3.008 V
+5V                : +5.056 V
-----
|><: Select Screen
|^v: Select Item
|Enter: Select
|+/-: Change Opt.
|F1: General Help
|F2: Previous Values
|F3: Optimized Defaults
|F4: Save & Exit
|ESC: Exit
-----
Version 2.21.1278 Copyright (C) 2021 AMI
```

- **Serial Port Console Redirection**

- **Console Redirection**

Use this item to enable or disable console redirection. The settings specify how the host computer and remote computer (which the user is using) will exchange data. Both computers should have the same or compatible setting.

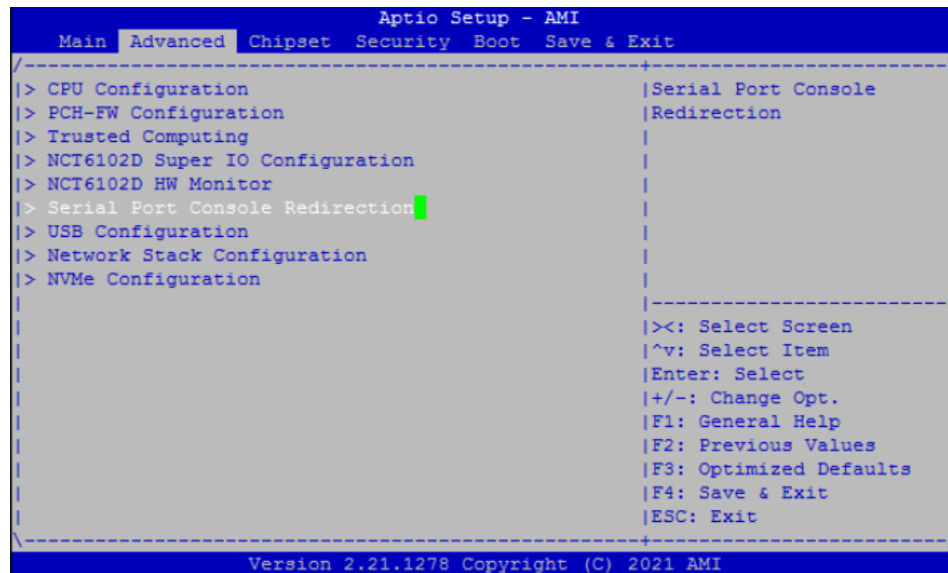

- **Console Redirection Settings**

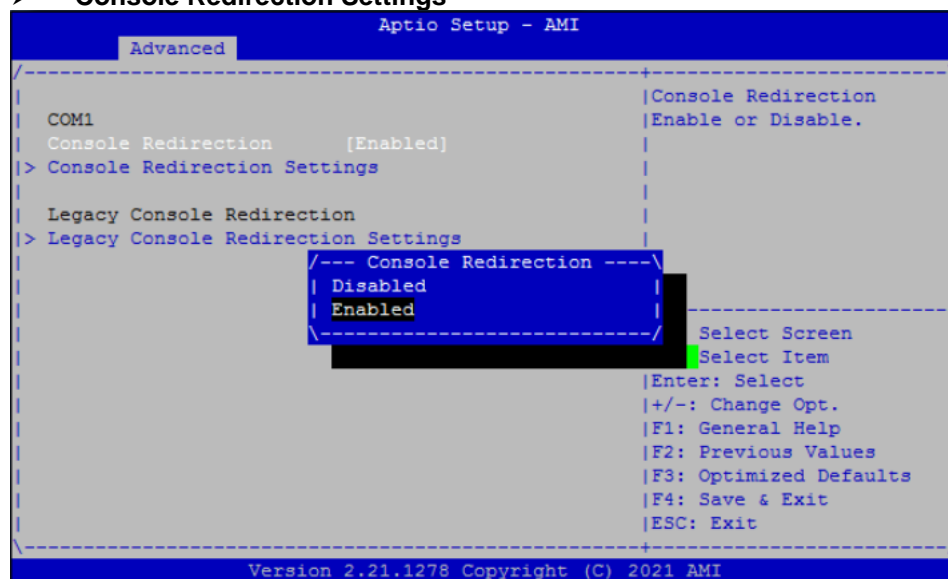

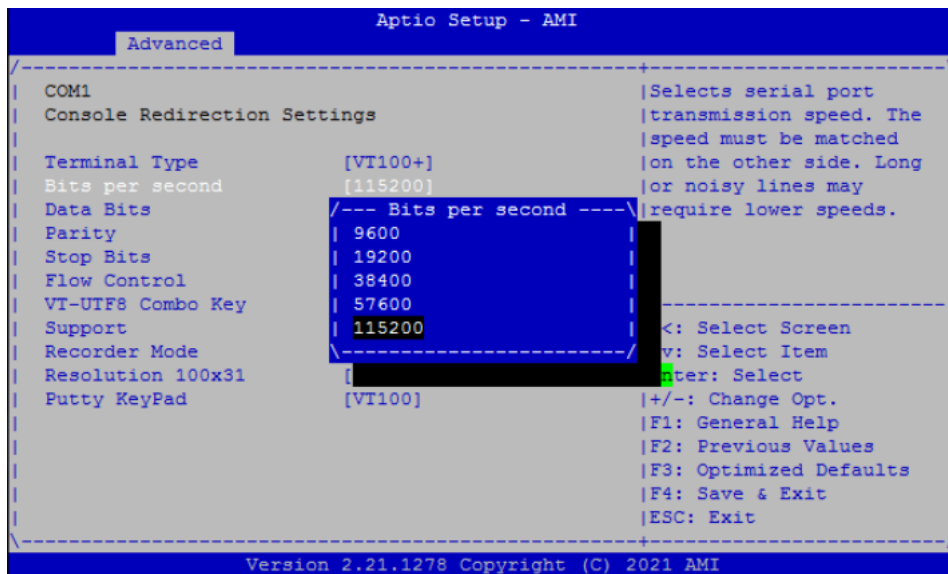
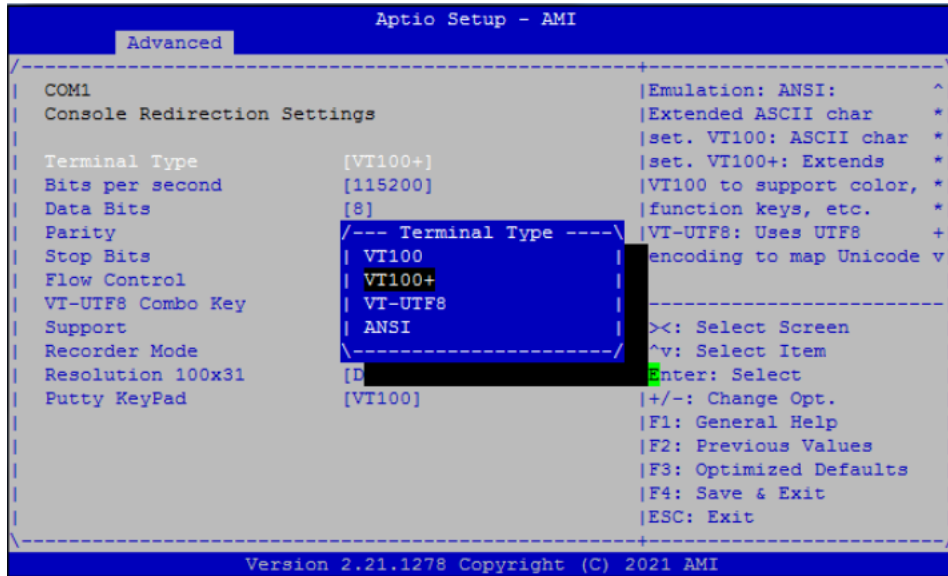

Terminal Type

This item allows you to select the target terminal type. Configuration options: ANSI, VT100, VT100+ and VT-UTF8.

Bits per second

This item allows you to setup the data transfer rate for the console port. The default value is 115200. Available options are "9600", "19200", "38400", "57600" and "115200".

Data Bits

This item allows you to select the data bits. The configuration options: 7 and 8.

Parity

This item allows you to select flow control for console redirection. The configuration options: None, Even, Odd, Mark and Space.

Stop Bits

This item allows you to select the data bits. The configuration options: 1 and 2.

Flow Control

This item allows you to select flow control for console redirection. The configuration options: None and Hardware RTS/CTS.

VT-UTF8 Combo Key Support

Use this item to Enabled and Disabled VT-UTF8 combination key supports for ANSI / VT100 terminals.

Recorder Mode

This item allows you to select the recorder mode. The configuration options: Enabled and Disabled.

Resolution 100x31

Use this item to Enable and Disabled this item.

Putty keypad

This item allows you to select the Putty keypad. The configuration options: VT100/LINUX/XTERMR6/SCO/ESCN/VT400.

- **USB Configuration**

Use this item for further setting USB port configuration.

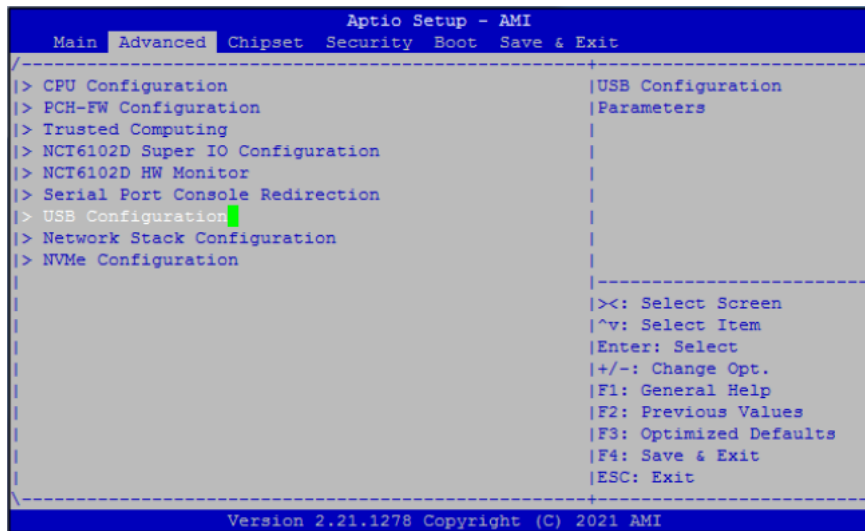

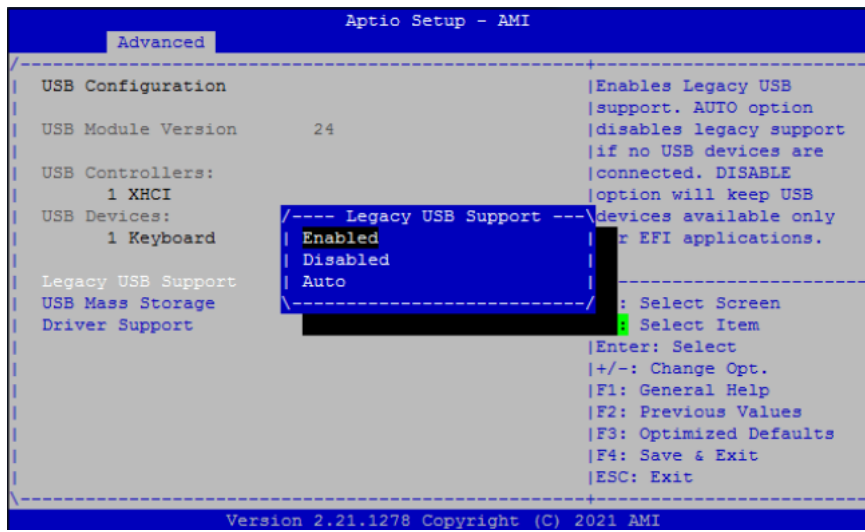

USB Mass Storage Driver Support

Enable this field USB can be storage. This should be enabled this field.

- **Network Stack Configuration**

For Network stack, use Network item to "Disabled" or "Enabled" mode.

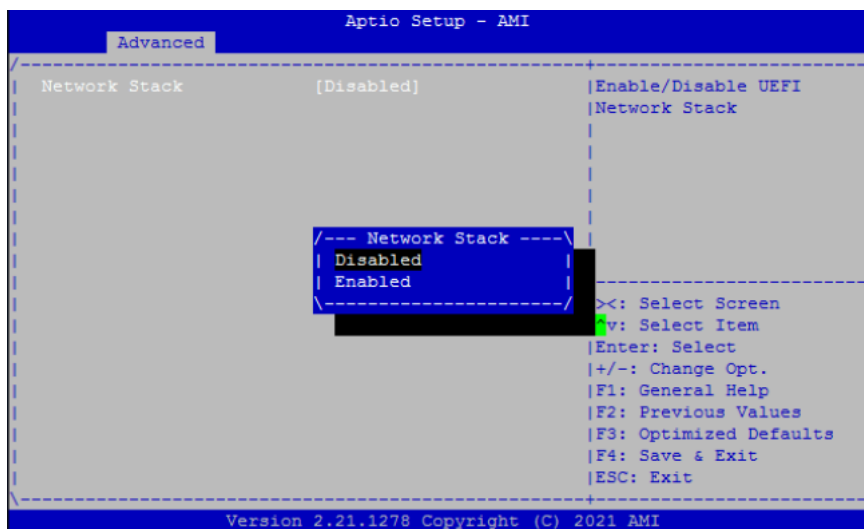
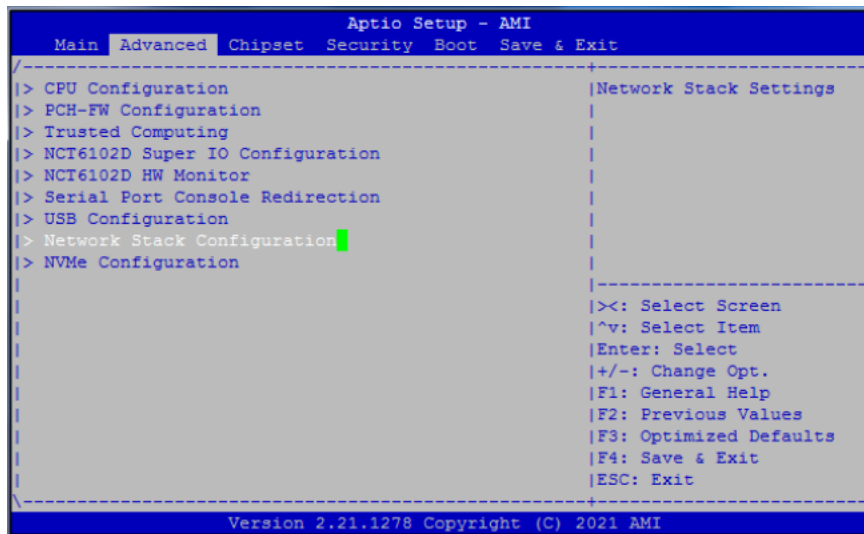

- **NVMe Configuration**

This screen shows the NVMe Configuration, and you can see the NVMe controller and drive information.

```
Aptio Setup - AMI
Main  Advanced  Chipset  Security  Boot  Save & Exit

|> CPU Configuration          |NVMe Device Options
|> PCH-FW Configuration      |Settings
|> Trusted Computing
|> NCT6102D Super IO Configuration
|> NCT6102D HW Monitor
|> Serial Port Console Redirection
|> USB Configuration
|> Network Stack Configuration
|> NVMe Configuration      |
|                             |
|                             |><: Select Screen
|                             |^v: Select Item
|                             |Enter: Select
|                             |+/-: Change Opt.
|                             |F1: General Help
|                             |F2: Previous Values
|                             |F3: Optimized Defaults
|                             |F4: Save & Exit
|                             |ESC: Exit

Version 2.21.1278 Copyright (C) 2021 AMI
```

```
Aptio Setup - AMI
Advanced

NVMe controller and Drive information
Bus:2 Dev:0 Func:0      INTEL SSDPEKKW128G8
Nvme Size              128.0GB

|                             |><: Select Screen
|                             |^v: Select Item
|                             |Enter: Select
|                             |+/-: Change Opt.
|                             |F1: General Help
|                             |F2: Previous Values
|                             |F3: Optimized Defaults
|                             |F4: Save & Exit
|                             |ESC: Exit

Version 2.21.1278 Copyright (C) 2021 AMI
```

- **LBP @PowerOn (All SEG)**

For Power On LAN Bypass setting, use LBP @PowerOn item to “Disabled”, “Enabled” or “Last State” for LAN Bypass all segments.

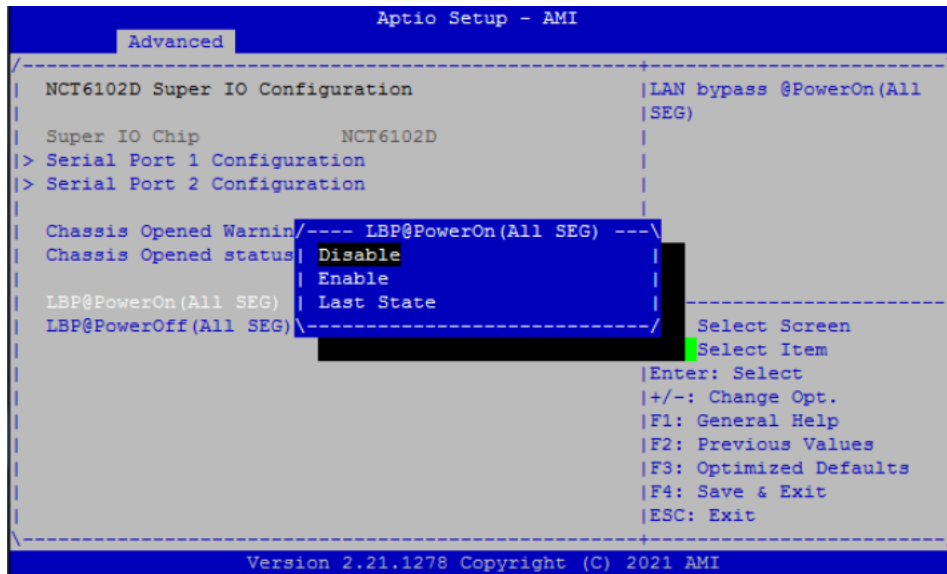

- **LBP @Power Off (All SEG)**

For Power off LAN Bypass setting, use LBP @PowerOff item to “Disabled”, “Enabled” or “Last State” for LAN Bypass all segments.

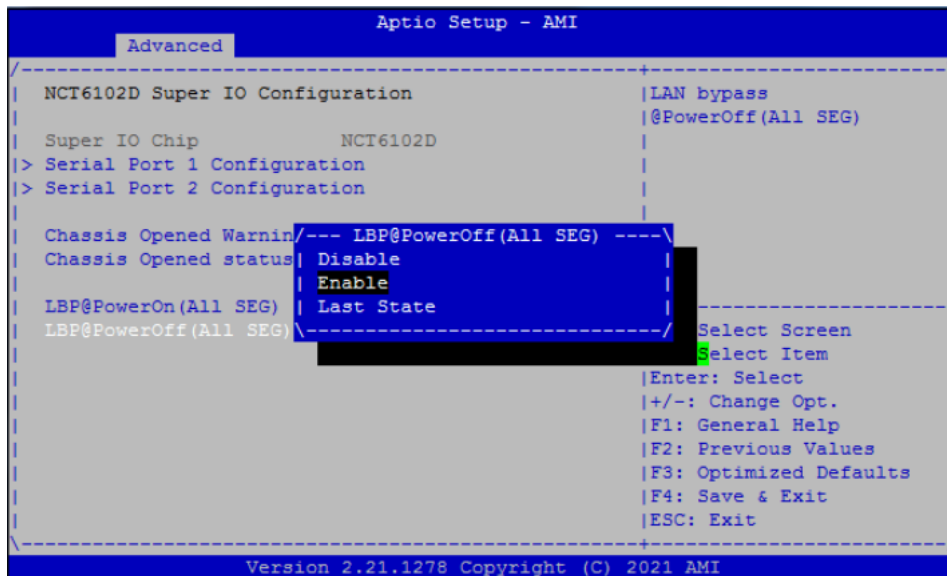

3.5 Chipset Menu

The Chipset menu allows users to change the advanced chipset settings. You can select any of the items in the left frame of the screen to go to the sub menus:

- ▶ System Agent (SA) Configuration
- ▶ PCH-IO Configuration

For items marked with “▶”, please press <Enter> for more options.

```
Aptio Setup - AMI
Main  Advanced  Chipset  Security  Boot  Save & Exit

> System Agent (SA) Configuration
> PCH-IO Configuration

System Agent (SA)
Parameters

-----
|><: Select Screen
|^v: Select Item
|Enter: Select
|+/-: Change Opt.
|F1: General Help
|F2: Previous Values
|F3: Optimized Defaults
|F4: Save & Exit
|ESC: Exit

Version 2.21.1278 Copyright (C) 2021 AMI
```

- **System Agent (SA) Configuration**

- **Memory Configuration**

This screen allows users to configure parameters of North Bridge Chipset.

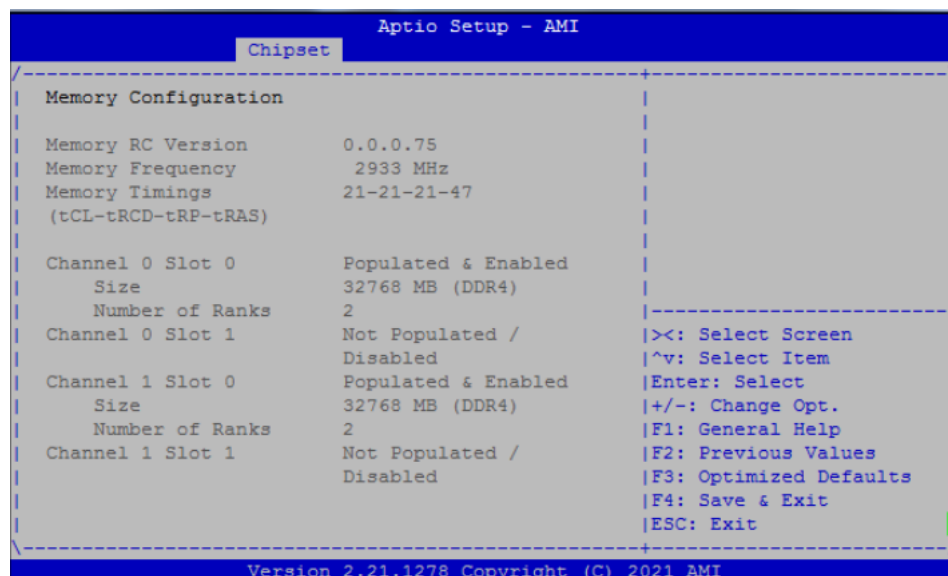
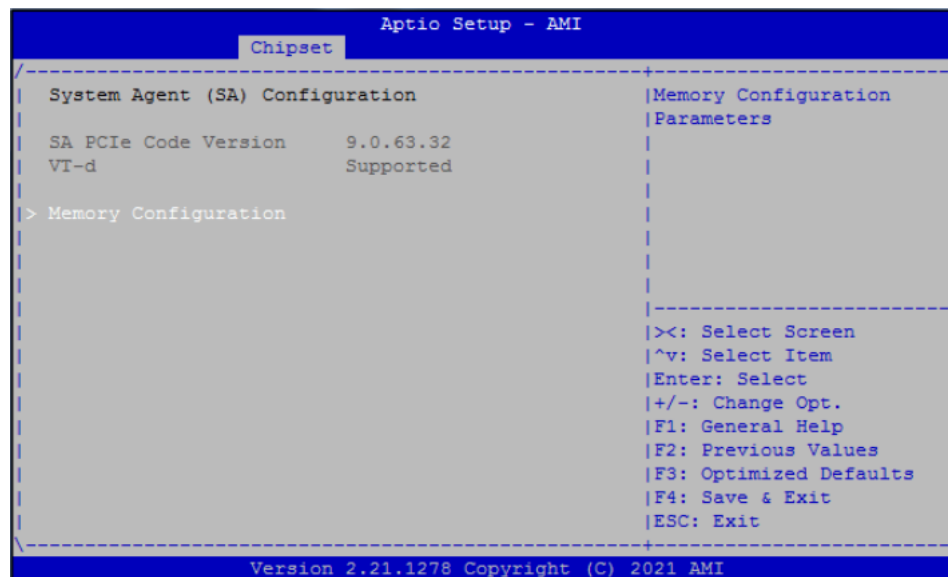

● PCH-IO Configuration

```

Aptio Setup - AMI
Main  Advanced  Chipset  Security  Boot  Save & Exit

|> System Agent (SA) Configuration
|> PCH-IO Configuration
|
|
|
|
|-----|
|<: Select Screen
|^v: Select Item
|Enter: Select
|+/-: Change Opt.
|F1: General Help
|F2: Previous Values
|F3: Optimized Defaults
|F4: Save & Exit
|ESC: Exit
|
|-----|
Version 2.21.1278 Copyright (C) 2021 AMI

```

```

Aptio Setup - AMI
Chipset

SATA And RST Configuration
SATA Controller(s) [Enabled]
SATA Mode Selection [AHCI]
Serial ATA Port 1 WDC WD3200LPCX (320.0GB)
Serial ATA Port 2 WDC WD5000LPCX (500.1GB)
Serial ATA Port 3 KINGSTON RBUSN (128.0GB)
Serial ATA Port 4 Empty
Serial ATA Port 5 Empty
Serial ATA Port 6 Empty
Serial ATA Port 7 Empty
Serial ATA Port 8 Empty
Enable/Disable SATA Device.
|<: Select Screen
|^v: Select Item
|Enter: Select
|+/-: Change Opt.
|F1: General Help
|F2: Previous Values
|F3: Optimized Defaults
|F4: Save & Exit
|ESC: Exit
|
|-----|
Version 2.21.1278 Copyright (C) 2021 AMI

```

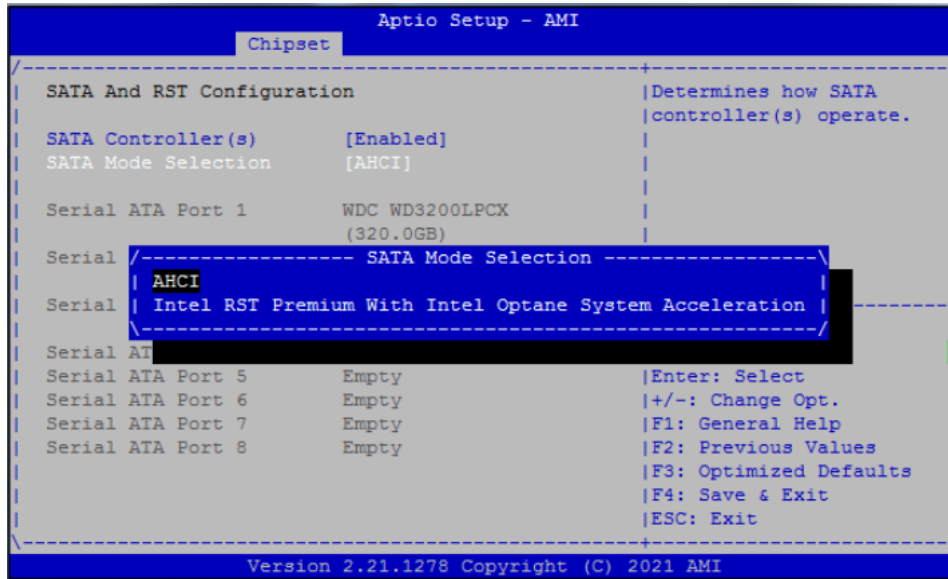

3.6 Security Menu

The Security menu allows users to change the security settings for the system.

- **Administrator Password**

This item indicates whether an administrator password has been set. If the password has been installed, Installed displays. If not, Not Installed displays.

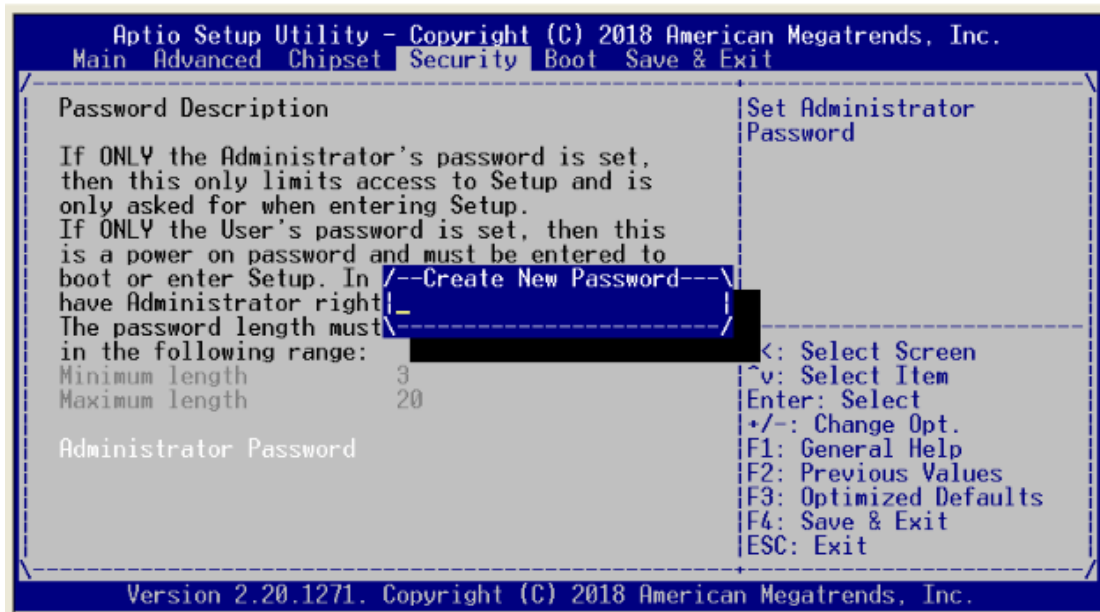

- **User Password**

This item indicates whether a user password has been set. If the password has been installed, Installed displays. If not, Not Installed displays.

3.7 Boot Menu

The Boot menu allows users to change boot options of the system.

- **Setup Prompt Timeout**

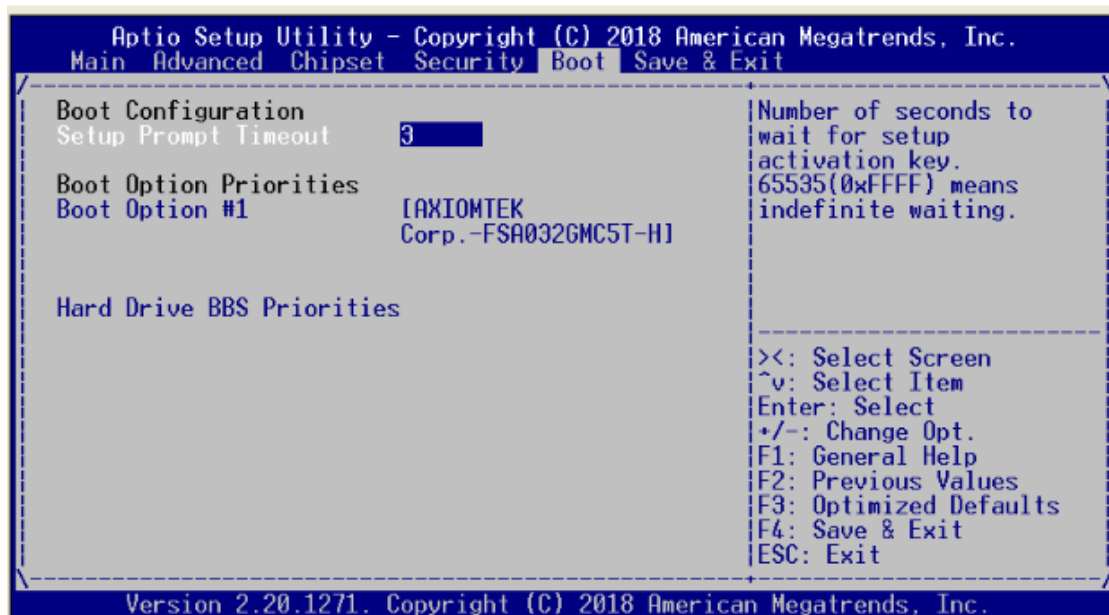

3.8 Save & Exit Menu

The Save & Exit menu allows users to load your system configuration with optimal or fail-safe default values.

- **Save Changes and Exit**

When you have completed the system configuration changes, select this option to leave Setup and return to Main Menu. Select Save Changes and Exit from the Save & Exit menu and press <Enter>. Select Yes to save changes and exit.

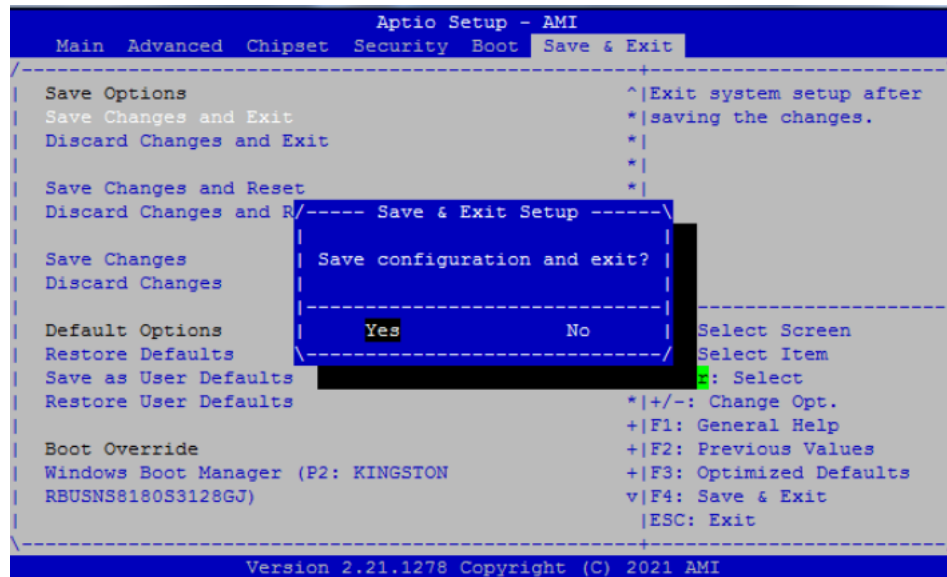

● **Discard Changes and Exit**

Select this option to quit Setup without making any permanent changes to the system configuration and return to Main Menu. Select Discard Changes and Exit from the Save & Exit menu and press <Enter>. Select Yes to discard changes and exit.

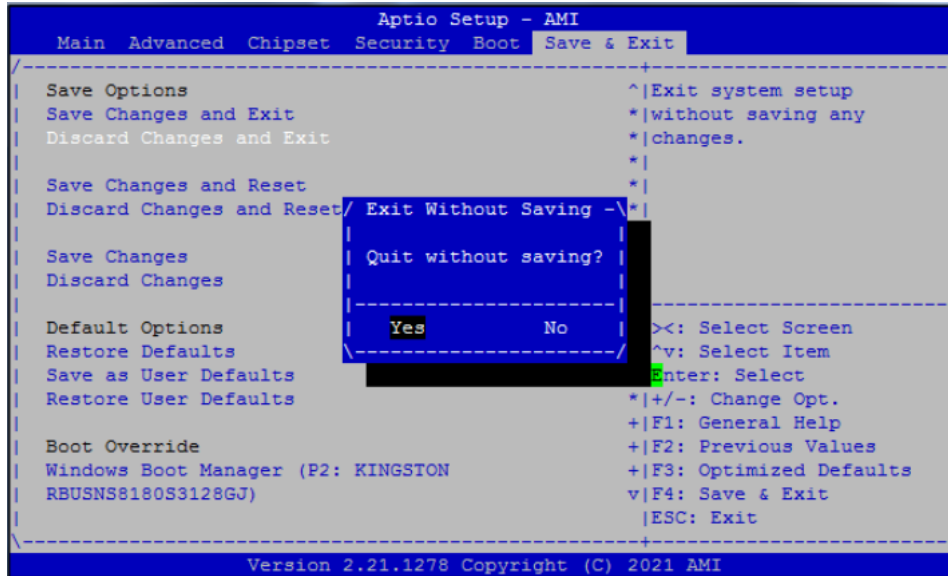

● **Save Changes and Reset**

When you have completed the system configuration changes, select this option to leave Setup and reboot the computer so the new system configuration parameters can take effect. Select Save Changes and Reset from the Save & Exit menu and press <Enter>. Select Yes to save changes and reset.

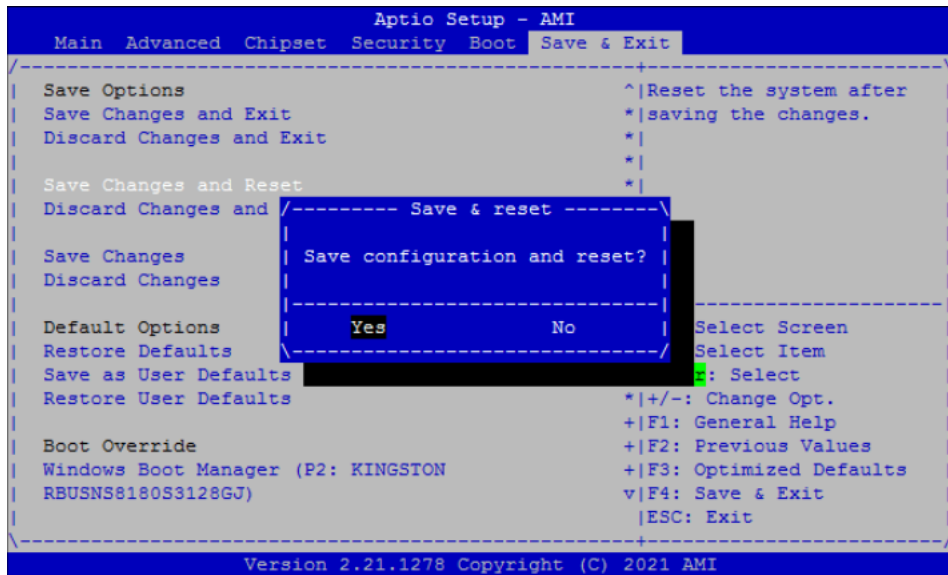

- **Discard Changes and Reset**

Select this option to quit Setup without making any permanent changes to the system configuration and reboot the computer. Select Discard Changes and Reset from the Save & Exit menu and press <Enter>. Select Yes to discard changes and reset.

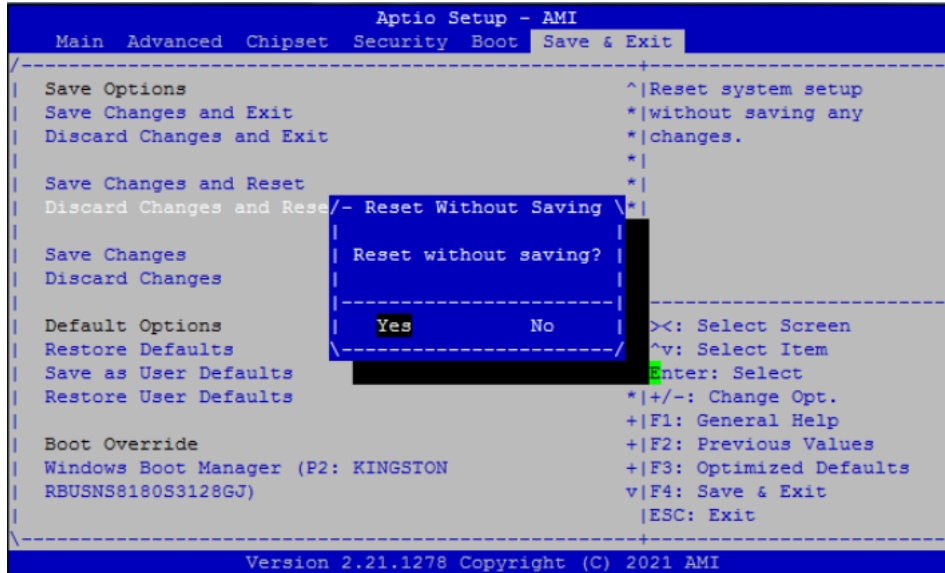

- **Save Changes**

When you have completed the system configuration changes, select this option to save changes. Select Save Changes from the Save & Exit menu and press <Enter>. Select Yes to save changes.

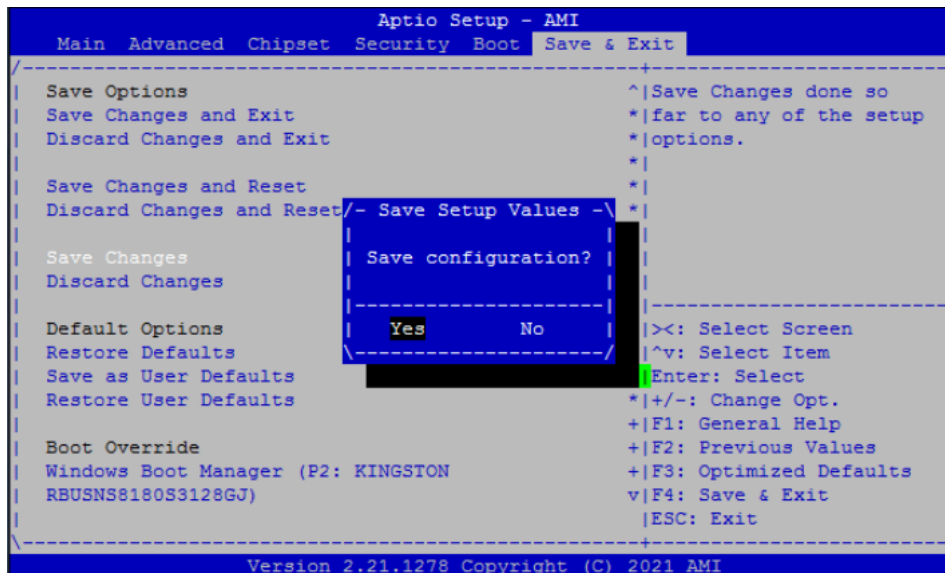

● **Discard Changes**

Select this option to quit Setup without making any permanent changes to the system configuration. Select Discard Changes from the Save & Exit menu and press <Enter>. Select Yes to discard changes.

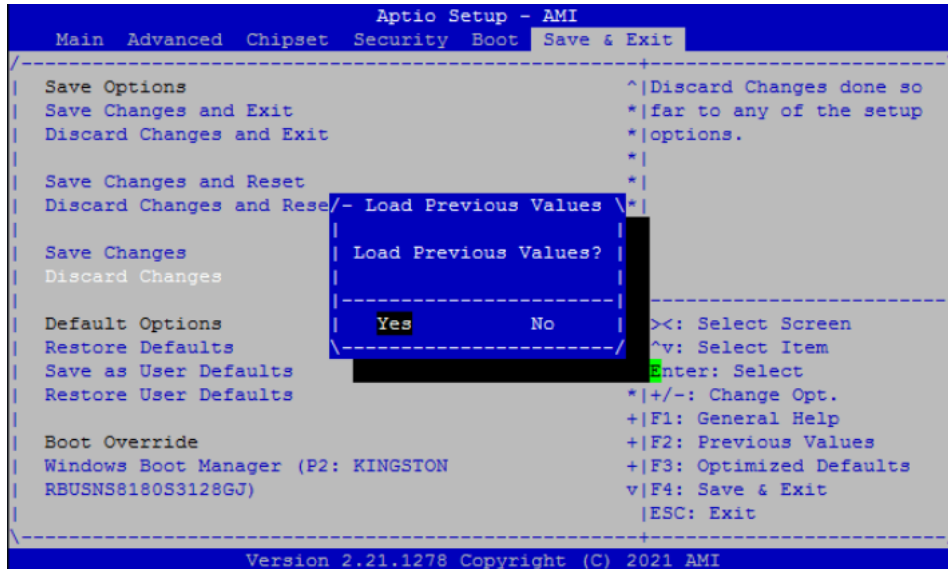

● **Restore Defaults**

It automatically sets all Setup options to a complete set of default settings when you select this option. The Optimal settings are designed for maximum system performance but may not work best for all computer applications. In particular, do not use the Optimal Setup options if your computer is experiencing system configuration problems. Select Restore Defaults from the Save & Exit menu and press <Enter>.

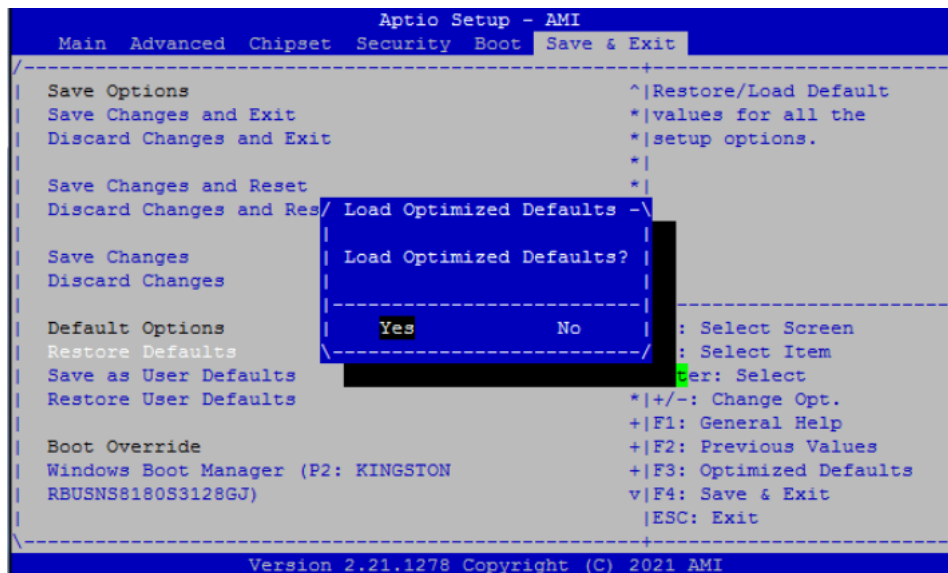

● **Save as User Defaults**

Select this option to save system configuration changes done so far as User Defaults. Select Save as User Defaults from the Save & Exit menu and press <Enter>.

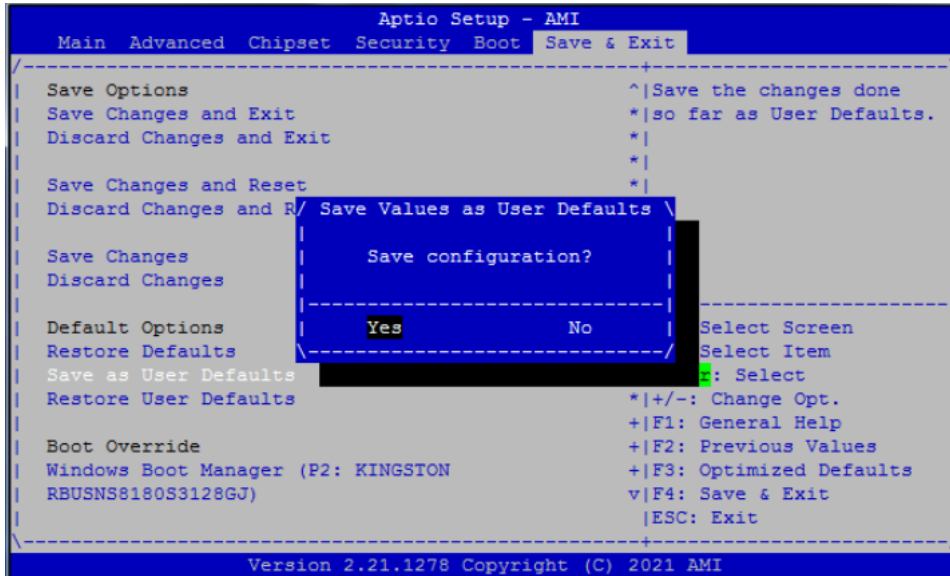

● **Restore User Defaults**

It automatically sets all Setup options to a complete set of User Defaults when you select this option. Select Restore User Defaults from the Save & Exit menu and press <Enter>.

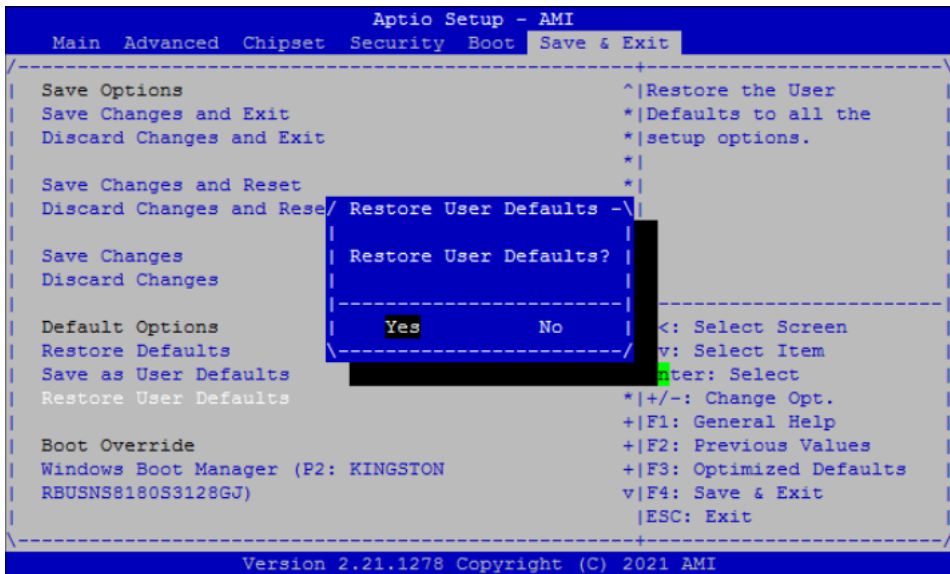

This page is intentionally left blank.

Appendix A

LAN Bypass Configuration

About LAN Bypass

In network security application, it is very important to ensure that network traffic to continue passing through the device even if hardware failure occurs or operating system crashes. LAN bypass gives us a solution for this problem.

The NA592 series LAN bypass function is very flexible. It can be selected at any time and any stage. You can enable LAN bypass for power on state by BIOS, or by software program when entering into the OS.

Moreover, for power off state, you can set up LAN Bypass through BIOS, or use software program when entering into the OS. If you don't do any change, the state will keep the previous power off state.

The NA592 LAN bypass capability with the special designed latch relay circuitry. When LAN bypass function is enabled, a relay closes to act as a bridge to route network data flow between LAN module's LAN port 0 and LAN port 1 (or LAN port 2 and LAN port 3 etc.). Motherboard has 2 pairs of latch-type LAN bypass LAN port 3 and LAN port 4/ LAN port 5 and LAN port 6 see below image. The bypass feature can be activated immediately or according to timer which is configurable from 1 up to 64 seconds. You can write a software program to control bypass operation behavior to fit your requirement. A LAN bypass sample program is provided on website or contact our FAE directly.

LAN Bypass Register Configuration

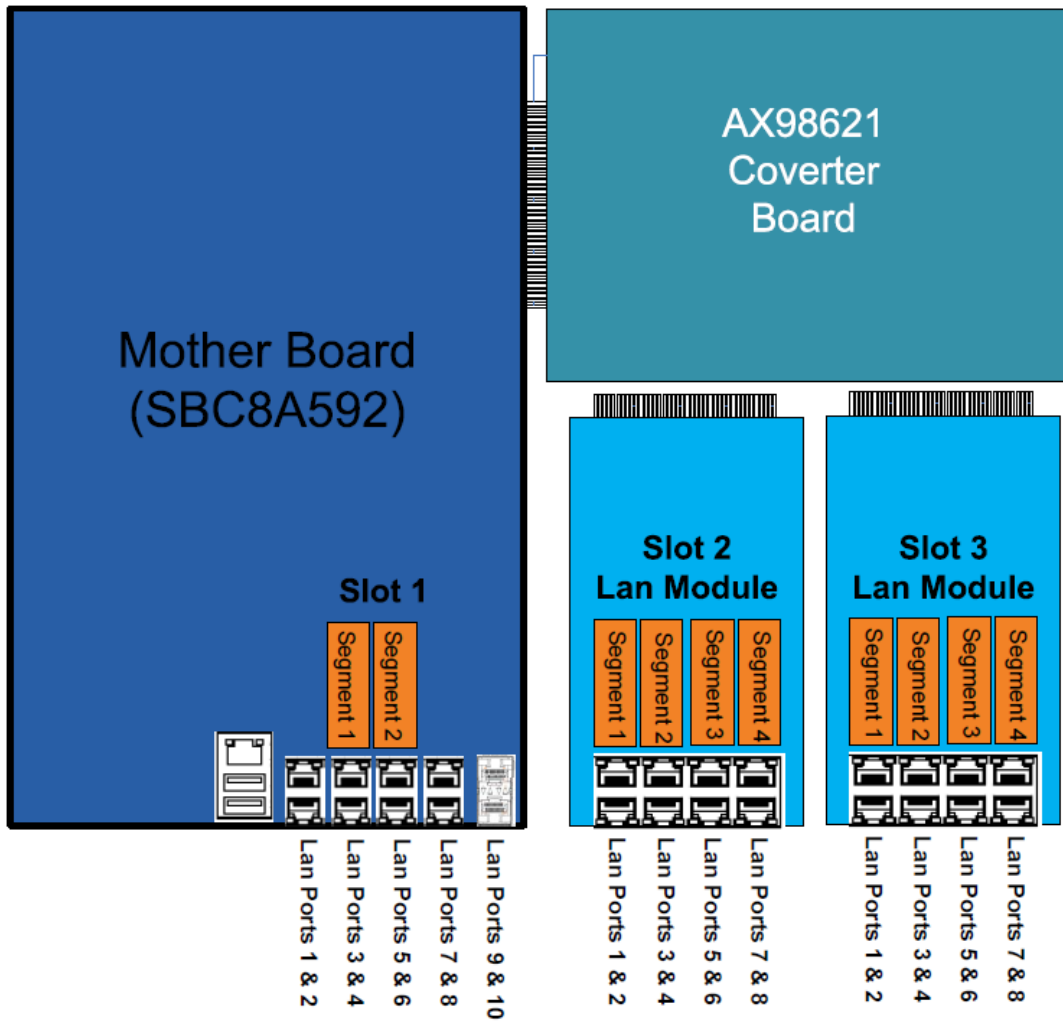

- **Power ON Bypass Control Register**

Address:

Mother board/Slot1	LAN module/Slot2	LAN module/Slot3
0x8E0	0x8E4	0x8E8

7	6	5	4	3	2	1	0
BYM1	BYM0	X	X	SEGN4	SEGN3	SEGN2	SEGN1
W	W	--	--	W	W	W	W

Default value: 00000000

Bit 7~6 BYM1~0

These bits are used to set bypass mode.

00 Not used.

01 Force bypass enable

Relay closes immediately to form LAN bypass on selected segment when power on.

10 Force bypass disable

LAN bypass is disabled immediately on selected segment when power on.

- 11 Timers enable
When power on, the selected segments are controlled by the setting of LAN bypass Timer Control register.

Bit 5~4 Not used.

Bits 3~0 SEGN4~1

Select each segment by setting the corresponding bit to 1. When the bit is set to 0, no action happens upon the segment.

Data read back from this register is not defined and therefore must be ignored. Reading from this register makes no effect on LAN bypass function. All data in this register will be cleared when system is turned off. If you still want to use power on LAN bypass function, turn on the system and make sure to rewrite the register. Otherwise, if you don't rewrite the register, the status will be kept on power off bypass state.

- **Power OFF Bypass Control Register**

Address:

Mother board/Slot1	LAN module/Slot2	LAN module/Slot3
0x8E1	0x8E5	0x8E9

7	6	5	4	3	2	1	0
X	X	X	X	SEGF4	SEGF3	SEGF2	SEGF1
--	--	--	--	W	W	W	W

Default value: 00000000

Bit 7~4 Not used.

Bits3~0 SEGF4~1

Use the corresponding bit to configure each segment. Setting the bit to 1 enables LAN bypass on the segment when power off. Clearing the bit to 0 disables LAN bypass on the segment when power off.

Data read back from this register is not defined and therefore must be ignored. Reading from this register makes no effect on LAN bypass function. When system is turned off, last data written onto this register will be kept. If you want to make any change, turn on the system and make sure to reconfigure the register.

- **LAN Bypass Timer Control Register**

Address:

Mother board/Slot1	LAN module/Slot2	LAN module/Slot3
0x8E2	0x8E6	0x8EA

7	6	5	4	3	2	1	0
TEXP	X	X	X	X	TVAL2	TVAL1	TVAL0
R	--	--	--	--	W	W	W

Default value: 00000000

Bit 7 TEXP (Read Only)
 This bit indicates status of hardware timer.
 0 Timer has not expired
 1 Timer has expired

Bits 6~3 Not used.

Bits 2~0 TVAL2~0
 These bits determine the amount of count value in second(s).
 001 1 (sec)
 010 2 (sec)
 011 4 (sec)
 100 8 (sec)
 101 16 (sec)
 110 32 (sec)
 111 64 (sec)
 000 Timer is not activated.

Writing a value to these bits will reset the hardware timer. The counting process begins again according to the new written value. Software must write count value periodically to ensure that timer will never expire. If timer timeout occurs, relay(s) automatically close to form LAN bypass on selected segment(s) based on the setting of Power On Bypass Control register (SEGN4~SEGN1).

Data (bits 6~0) read back from this register is not defined and therefore must be ignored. A read operation upon this register should not refresh the hardware timer.

- **LAN Bypass Status / Firmware Version Register**

Address:

Mother board/Slot1	LAN module/Slot2	LAN module/Slot3
0x8E3	0x8E7	0x8EB

7	6	5	4	3	2	1	0
VER3	VER2	VER1	VER0	BY4	BY3	BY2	BY1
R	R	R	R	R	R	R	R

Bit3~0 Lan Bypass Seg.1 status → Disable=0; Enable=1
 Bit 7~4 Firmware version
 Without LAN bypass function=1111

Appendix B

WDT Timer for System Reset

WDT (Watchdog Timer)

The hardware supports the WDT (Watchdog Timer) function. While time-out happens after a defaulted period, the WDT will reset the system.



Note: *The sample codes for the above features can be found in the CD, and they are only for customers' reference as remarked.*

This page is intentionally left blank.

Appendix C

LAN Module Expansion







You can install LAN module(s) into NA592 front-accessible expansion slots to meet your application requirement. Here are some LAN module configurations for your selection:

● LAN Modules

Slim Module	Ports	Chipset	Bypass	NA720
GbE Copper Modules				
AX93316-8GI	8	Intel i350AM4	0	v
AX93316-8GIL	8	Intel i350AM4	4	v
AX93336-4GI	4	Intel i210AT	2	v
AX93336-4GIL	4	Intel i350	2	v
GbE Fiber Modules				
AX93322-8FI	8	Intel i350AM4	0	v
AX93322-8MIL	4+4	Intel i350AM4	2	v
AX93336-4FI	4	Intel i350AM4	0	v
10GbE Copper Modules				
AX93317-2GIL	2	Intel X540	1	v
10GbE Fiber Modules				
AX93307-2FI	2	Intel 82599ES	0	v
AX93307-2FIL	2	Intel 82599ES	1	v
AX93327-4FI	4	Intel XL710	0	v

LAN Bypass Control Jumper (JP2/JP3)

Use this jumper to select the LAN Bypass Function.

Description	Function	Jumper
LAN Bypass Trigger when Power On	All SEG. Bypass as same as Power Off status	<p>JP3</p>  <p>JP2</p> 
	All SEG Bypass Disable (Default)	<p>JP3</p>  <p>JP2</p> 
	All SEG Bypass Enable	<p>JP3</p>  <p>JP2</p> 



Note: When the system is turned on, you can select LAN bypass function by Jumper and Bios when power on state, when enter the OS, you can select LAN bypass function at power on/ off state by software, the detail information please refer to the appendix A.

LED Definition

AX93316



LAN bypass LED

- **LAN bypass LED**
While running the LAN By-Pass function, the LED always lights up.
- **Active LED (Single color) for LAN port #1, port#2, port#3, port#4, port #5, port#6, port#7, port#8**
 - The orange LED is on when the LAN port connection is working.
 - The LED flashes when transmitting or receiving any signals to or from the appliance.
 - The LED is dark when the appliance is off.
- **Link LED for LAN port #1, port#2, port#3, port#4, port#5 and port#6, port#7, port#8**
 - The double-color LED light indicates 10/100/1000Mbps transfer rate.
 - When the orange-color LED light is radiating, it should be 1000Mbps transfer rate.
 - When the green-color LED light is radiating, it should be 100Mbps transfer rate.
 - If the Link LED is dark and Active LED is light on or flashing, it should be 10Mbps transfer rate.

When this LED and Link / Active LED both are dark. No networking devices are attached

Transfer Rate	LED Light Color
10Mbps	Dark
100Mbps	Green
1000Mbps	Orange

AX93336-4GIL

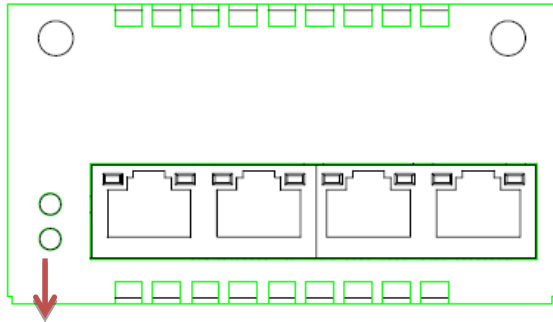

LAN bypass LED

- **LAN bypass LED**
While running the LAN By-Pass function, the LED always lights up.
- **Active LED (Single color) for LAN port #1, port#2, port#3, port#4**
 - The orange LED is on when the LAN port connection is working.
 - The LED flashes when transmitting or receiving any signals to or from the appliance.
 - The LED is dark when the appliance is off.
- **Link LED for LAN port #1, port#2, port#3, port#4**
 - The double-color LED light indicates 10/100/1000Mbps transfer rate.
 - When the orange-color LED light is radiating, it should be 1000Mbps transfer rate.
 - When the green-color LED light is radiating, it should be 100Mbps transfer rate.
 - If the Link LED is dark and Active LED is light on or flashing, it should be 10Mbps transfer rate.

When this LED and Link/Active LED both are dark. No networking devices are attached

Transfer Rate	LED Light Color
10Mbps	Dark
100Mbps	Green
1000Mbps	Orange

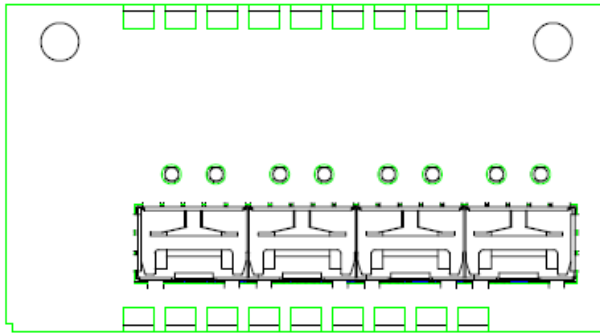

AX93336-4FI

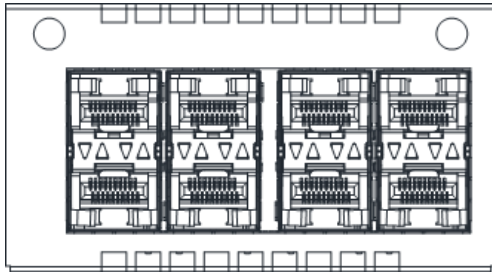

Transfer Rate	LED Light Color
<p>The diagram shows the four fiber ports with their corresponding LEDs. The first LED on the left is highlighted with a red square, indicating a specific transfer rate.</p>	<p>Fiber port Active: Orange</p>
<p>The diagram shows the four fiber ports with their corresponding LEDs. The second LED from the left is highlighted with a red square, indicating a different transfer rate.</p>	<p>Fiber port Link: Orange</p>

AX93322-8FI

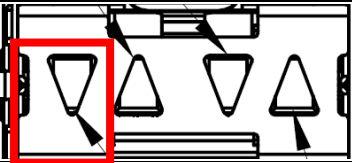
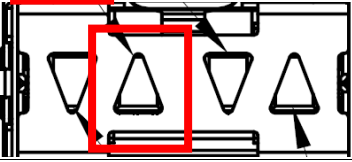
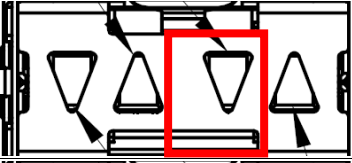

Transfer Rate	LED Light Color
	Down Fiber port Active: Orange
	Up Fiber port Active: Orange
	Down Fiber port Link: Orange
	Up Fiber port Link: Orange

AX93322-8MIL

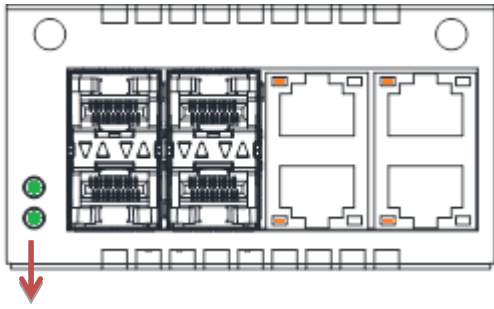

LAN bypass LED

FIBER:

Transfer Rate	LED Light Color
	Down Fiber port Active: Orange
	Up Fiber port Active: Orange
	Down Fiber port Link: Orange
	Up Fiber port Link: Orange

Copper:

- **LAN bypass LED**
While running the LAN By-Pass function, the LED always lights up.
- **Active LED (Single color) for LAN port #1, port#2, port#3, port#4**
 - The orange LED is on when the LAN port connection is working.
 - The LED flashes when transmitting or receiving any signals to or from the appliance.
 - The LED is dark when the appliance is off.
- **Link LED for LAN port #1, port#2, port#3, port#4**
 - The double-color LED light indicates 10/100/1000Mbps transfer rate.
 - When the orange-color LED light is radiating, it should be 1000Mbps transfer rate.
 - When the green-color LED light is radiating, it should be 100Mbps transfer rate.
 - If the Link LED is dark and Active LED is light on or flashing, it should be 10Mbps transfer rate.

When this LED and Link / Active LED both are dark. No networking devices are attached

Transfer Rate	LED Light Color
10Mbps	Dark
100Mbps	Green
1000Mbps	Orange

AX93317

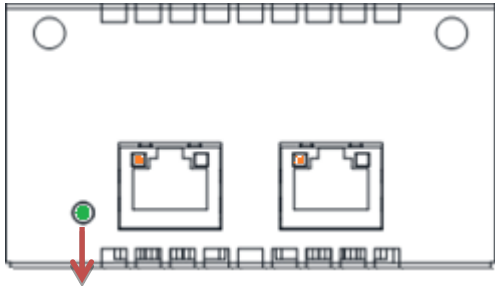

LAN bypass LED

- **LAN bypass LED**
While running the LAN By-Pass function, the LED always lights up.
- **Active LED (Single color) for LAN port #1, port#2**
 - The orange LED is on when the LAN port connection is working.
 - The LED flashes when transmitting or receiving any signals to or from the appliance.
 - The LED is dark when the appliance is off.
- **Link LED for LAN port #1, port#2**
 - The double-color LED light indicates 1000/10000Mbps transfer rate.
 - When the orange-color LED light is radiating, it should be 10000Mbps transfer rate.
 - When the green-color LED light is radiating, it should be 1000Mbps transfer rate.

When this LED and Link/Active LED both are dark. No networking devices are attached

Transfer Rate	LED Light Color
1000Mbps	Green
10000Mbps	Orange

AX93307

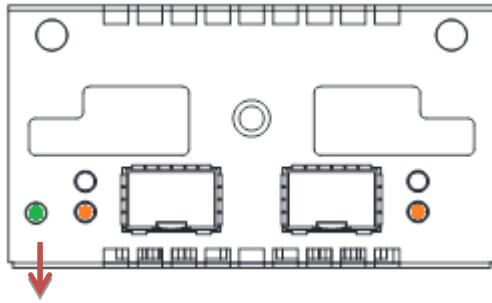

LAN bypass LED

- **LAN bypass LED**
While running the LAN By-Pass function, the LED always lights up.
- **Active LED (Single color) for LAN port #1, port#2**
 - The orange LED is on when the LAN port connection is working.
 - The LED flashes when transmitting or receiving any signals to or from the appliance.
 - The LED is dark when the appliance is off.
- **Link LED for LAN port #1, port#2**
 - The double-color LED light indicates 1000/10000Mbps transfer rate.
 - When the orange-color LED light is radiating, it should be 10000Mbps transfer rate.
 - When the green-color LED light is radiating, it should be 1000Mbps transfer rate.

Transfer Rate	LED Light Color
1000Mbps	Green
10000Mbps	Orange

Appendix D

Warning

- This is a class A Product. In a domestic Environment this Product may cause radio interference in which case the user may be required to take adequate measures.

- It will be danger if battery is incorrectly replaced. Replacing only with the same or equivalent type is highly recommended by the manufacturer. Dispose of used batteries according to the manufacturer's instructions.

- **Warning for Hard Disk Drive Selection:**
TUV approved Hard Disk Drive is preferred for TUV compliance Hard Disk Drive-Optional, (NWGQ2), generic, Input Voltage rated 5V DC/1.0A, 12V DC/1.8A maximum. Minimum clearance from uninsulated live parts 4.0 mm.

- The equipment is to be installed in an environment with maximum ambient temperature must not exceed 40°C
- The openings on the enclosure are for air convection hence protected the equipment from overheating. DO NOT COVER THE OPENINGS.
- Lay this equipment on a reliable surface when install. A drop or fall could cause injury.
- The equipment shall be installed according to specification as nameplate. Make sure the voltage of the power source when connect the equipment to the power outlet.
- The current of load and output power of loads shall be not over the specification.
- This equipment must be connected to the reliable earthling before using.



Electric shock hazard inside the redundant power supply.
The exchange of modules shall be done by service person.

This page is intentionally left blank.