

USER'S MANUAL

MANO522 Series

**Intel® Socket 1151 Core™ i7/ i5/ i3
Processors Mini ITX Motherboard**

User's Manual



www.axiomtek.com

Disclaimers

This manual has been carefully checked and believed to contain accurate information. Axiomtek Co., Ltd. assumes no responsibility for any infringements of patents or any third party's rights, and any liability arising from such use.

Axiomtek does not warrant or assume any legal liability or responsibility for the accuracy, completeness or usefulness of any information in this document. Axiomtek does not make any commitment to update the information in this manual.

Axiomtek reserves the right to change or revise this document and/or product at any time without notice.

No part of this document may be reproduced, stored in a retrieval system, or transmitted, in any form or by any means, electronic, mechanical, photocopying, recording, or otherwise, without the prior written permission of Axiomtek Co., Ltd.

CAUTION

If you replace wrong batteries, it causes the danger of explosion. It is recommended by the manufacturer that you follow the manufacturer's instructions to only replace the same or equivalent type of battery, and dispose of used ones.

©Copyright 2020 Axiomtek Co., Ltd.

All Rights Reserved

November 2020, Version A2

Printed in Taiwan

ESD Precautions

Computer boards have integrated circuits sensitive to static electricity. To prevent chipsets from electrostatic discharge damage, please take care of the following jobs with precautions:

- Do not remove boards or integrated circuits from their anti-static packaging until you are ready to install them.
- Before holding the board or integrated circuit, touch an unpainted portion of the system unit chassis for a few seconds. It discharges static electricity from your body.
- Wear a wrist-grounding strap, available from most electronic component stores, when handling boards and components.

Trademarks Acknowledgments

Axiomtek is a trademark of Axiomtek Co., Ltd.

Intel[®] and Celeron[®] are trademarks of Intel Corporation.

Windows[®] is a trademark of Microsoft Corporation.

AMI is a trademark of American Megatrend Inc.

IBM, PC/AT, PS/2, VGA are trademarks of International Business Machines Corporation.

Other brand names and trademarks are the properties and registered brands of their respective owners.

Table of Contents

Disclaimers	ii
ESD Precautions.....	iii
Chapter 1 Introduction.....	1
1.1 Features.....	1
1.2 Specifications.....	2
1.3 Utilities Supported	3
1.4 Block Diagram.....	4
Chapter 2 Board and Pin Assignments.....	5
2.1 Board Layout.....	5
2.2 Rear I/O.....	6
2.3 Jumper Settings	7
2.3.1 Clear CMOS (JP1)	8
2.3.2 AT/ATX Power Mode Select (JP3)	8
2.3.3 COM1 RS-232/422/485 Mode Select (JP4, JP6, JP7)	9
2.3.4 COM1 Data/Power Select (JP5)	9
2.3.5 LVDS Backlight PWM/DC Mode Select (JP8).....	9
2.3.6 LVDS VDD Select (JP9).....	9
2.3.7 Case Open Select (JP10)	10
2.4 Connectors.....	11
2.4.1 SIM Card Slot (CN5)	12
2.4.2 mSATA Connector (CN6)	12
2.4.3 SATA 3.0 Connectors (CN7~CN8)	13
2.4.4 Front Panel Header (CN12)	13
2.4.5 USB 2.0 Port (CN13).....	14
2.4.6 ATX Power Input Connectors (CN16 and CN17).....	15
2.4.7 Fan Connectors (CN18 and CN19).....	16
2.4.8 GPIO Header (CN20).....	16
2.4.9 COM D-Sub Connector (CN21)	17
2.4.10 COM Headers (CN22~CN23 and CN36~CN37).....	17
2.4.11 LAN and USB 3.0 Connectors (CN26 and CN27)	18
2.4.12 Audio Jack (CN28)	18
2.4.13 Front Audio Header (CN29)	19
2.4.14 HDMI Connector (CN30).....	19
2.4.15 LVDS Signal Header (CN31).....	20
2.4.16 LVDS Backlight Control Header (CN32)	21
2.4.17 M.2 Key E Connector (CN34)	22
2.4.18 VGA Connector (CN35).....	23

Chapter 3	Hardware Description	25
3.1	Microprocessors	25
3.2	BIOS.....	25
3.3	System Memory	25
Chapter 4	AMI BIOS Setup Utility	27
4.1	Starting.....	27
4.2	Navigation Keys	27
4.3	Main Menu	29
4.4	Advanced Menu	30
4.5	Chipset Menu	43
4.6	Security Menu	49
4.7	Boot Menu.....	50
4.8	Save & Exit Menu.....	52
Appendix A	Watchdog Timer.....	55
A.1	About Watchdog Timer	55
A.2	Sample Program	55
Appendix B	TPM Settings.....	57

This page is intentionally left blank.

Section 1

Introduction

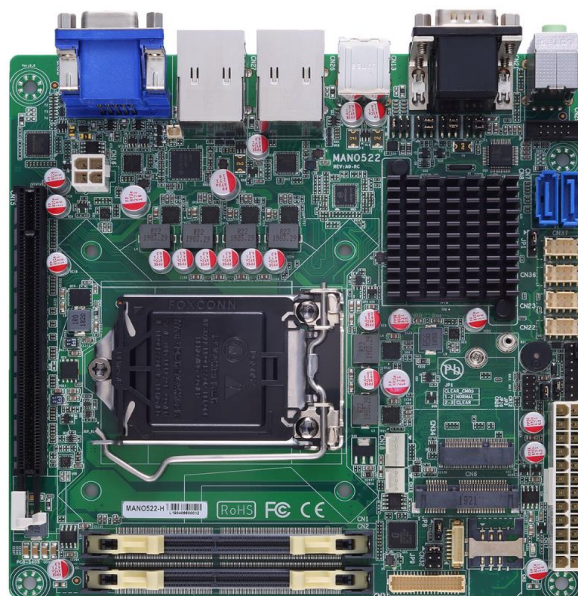

The MANO522 Mini-ITX motherboard supports the new 14nm 8th Generation Intel® Core™ i7/ i5/ i3 and Pentium® processors in LGA1151 package. Featuring the new Intel® H310 Express chipset with two DDR4 2400/2666MHz memory support, this motherboard is built to perform best stability and reliability for industrial applications.

It comes with two SATA 3.0, four USB 3.0, two USB 2.0 and one RS-232/422/485 port providing robust storage and I/O options. Users also can increase board functionality with PCI-Express x16 and mSATA slot. The high quality MANO522 allows four display interfaces via HDMI, one VGA and LVDS in quadruplicate views, making it an ideal solution for gaming, workstation, digital signage, medical and other IoT&M2M applications.

1.1 Features

- LGA1151 Socket for 8th Generation Intel® Core™ i7/ i5/ i3 and Pentium® processors (Coffee Lake)
- 2 DDR4 2400/2666MHz memory with maximum capacity up to 64GB
- 1 PCI-Express x16
- 1 mSATA (support SATA, USB 2.0 signal) and 1 SIM card slots
- 1 M.2 Key E, size: 22x30 for WiFi (support PCIE x1, USB 2.0 signal)
- 2 SATA-600
- 4 USB 3.0 and 2 USB 2.0

1.2 Specifications

- **CPU**
 - LGA1151 Socket for 8th Generation Intel® Core™ i7/ i5/ i3 and Pentium® processors.
- **Chipset**
 - Intel® H310.
- **BIOS**
 - AMI BIOS via SPI interface.
- **System Memory**
 - Two 260-pin SO-DIMM sockets.
 - Maximum up to 64GB DDR4 memory.
 - Support 2400/2666MHz.
- **Onboard Multi I/O**
 - Controller: ITE8786.
 - Six serial ports:
 - COM1 supports RS-232/422/485; COM2~COM6 support RS-232 only.
 - COM1~COM2 on the rear I/O; COM3~COM6 in wafer connectors.
- **USB Interface**
 - Four USB 3.0 ports (on the rear I/O).
 - Two USB 2.0 ports (on the rear I/O).
- **Ethernet**
 - LAN1: 1000/100/10Mbps Gigabit/Fast Ethernet supports Wake-on-LAN, PXE with Intel® i219LM.
 - LAN2: 1000/100/10Mbps Gigabit/Fast Ethernet supports Wake-on-LAN, PXE with Intel® i211AT.
- **Serial ATA**
 - Two SATA 3.0 port (6Gb/s).
 - One mSATA slot.
- **Audio**
 - Realtek ALC662 5.1 channel HDA codec.
 - Support MIC-in/line-out (on the rear I/O).
 - Support MIC-in/line-out/line-in in box headers (internal).
- **Display**
 - One HDMI with resolution max. up to 3840x2160 @30Hz.
 - One VGA with resolution max. up to 1920 x 1200 @60Hz.
 - One 24-bit dual channel LVDS and one 8-pin inverter connector. LVDS resolution is max. up to 1920x1200.
- **Expansion Interface**
 - One PCI-Express x16 slot.
 - One SIM card slot.
 - One M.2 Key E slot

- **Power Input**
 - One ATX power input connector.
 - One 12V ATX power input connector for CPU power.
- **Operating Temperature**
 - 0°C ~ 60°C.
- **Storage Temperature**
 - -20°C ~ 65°C.
- **Form Factor**
 - Mini ITX (6.7" x 6.7", 17.0cm x 17.0cm).



All specifications and images are subject to change without notice.

Note

1.3 Utilities Supported

- Chipset driver
- Graphics driver
- Intel ME driver
- Ethernet driver
- Audio driver
- Intel_Rapid_Storage_Technology driver

1.4 Block Diagram

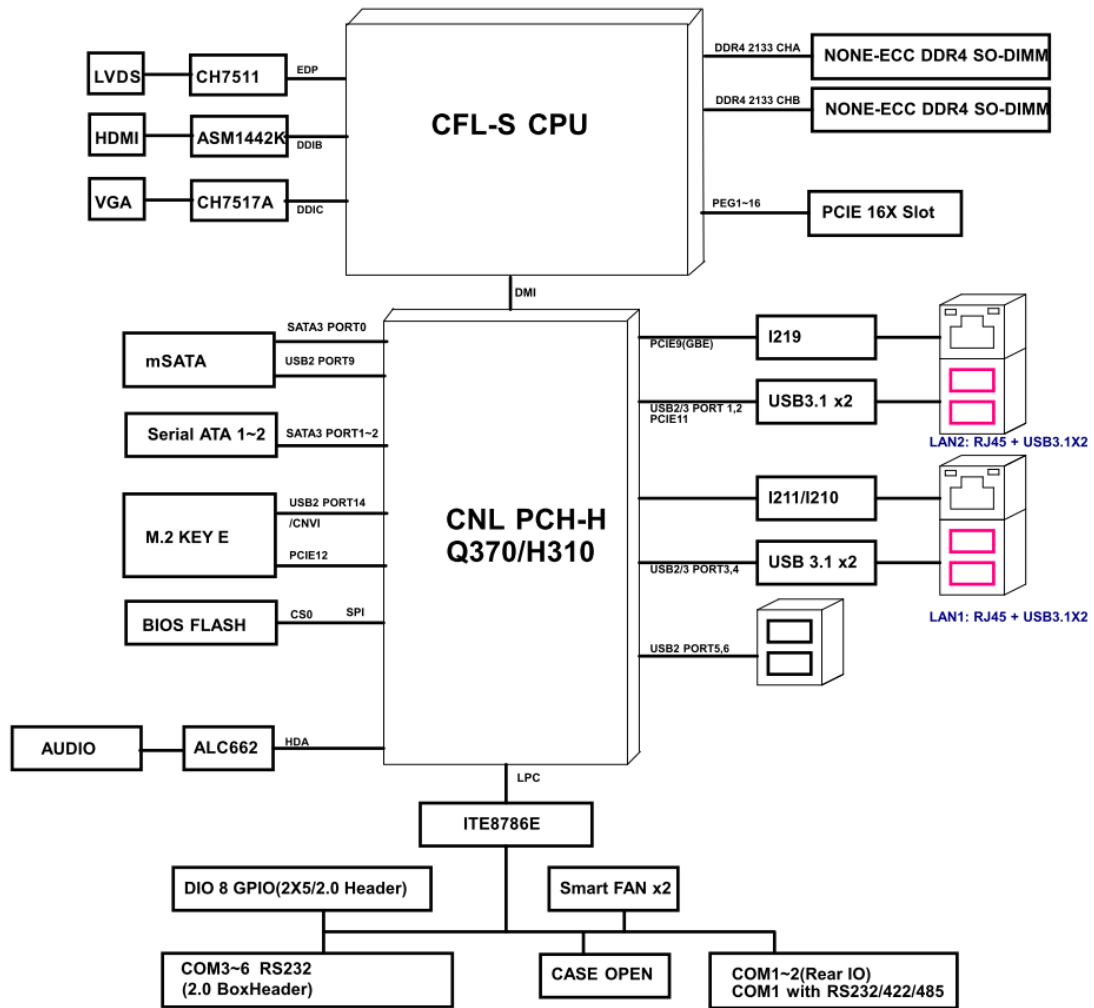

Section 2

Board and Pin Assignments

2.1 Board Layout

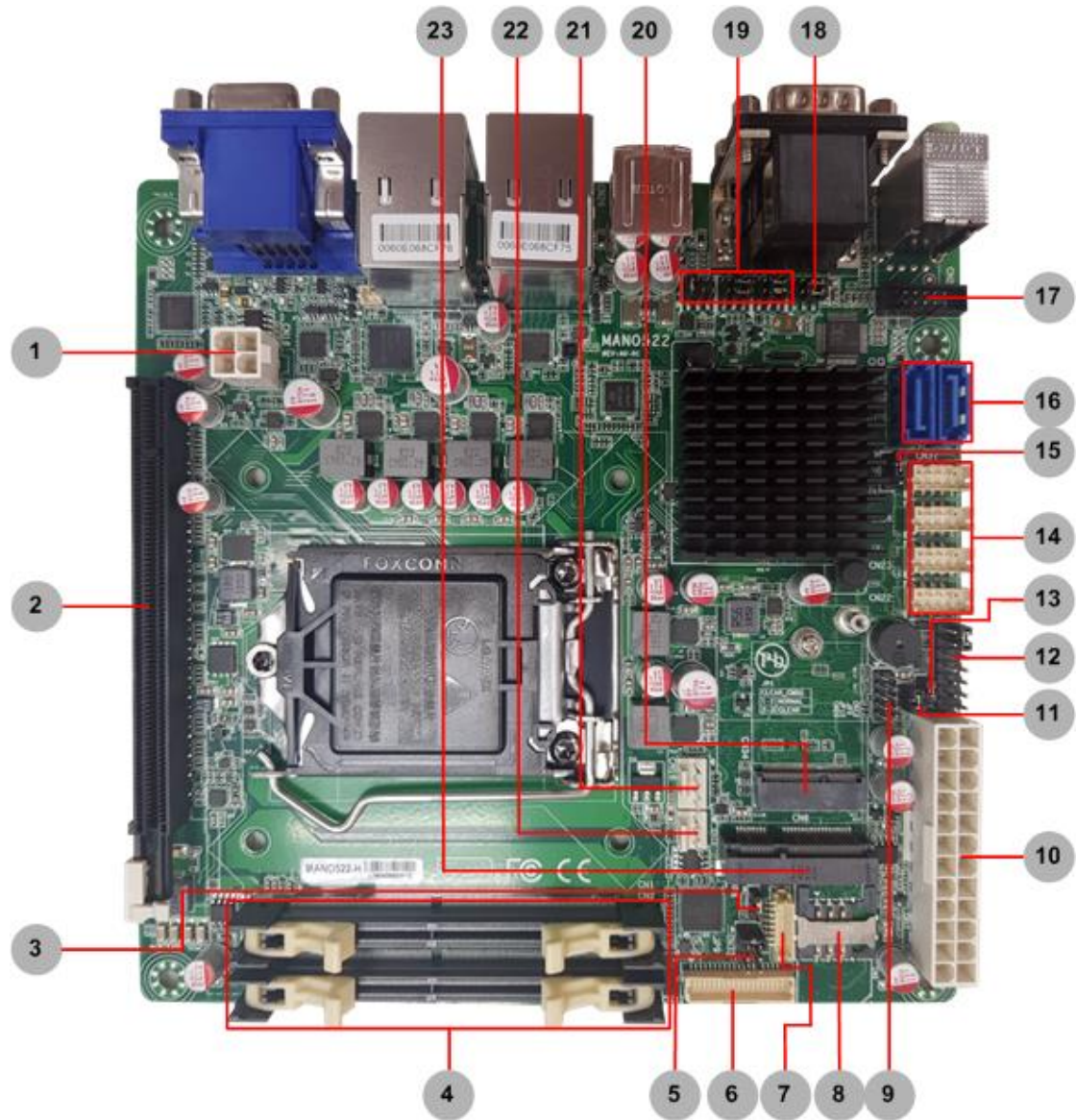

2.2 Rear I/O

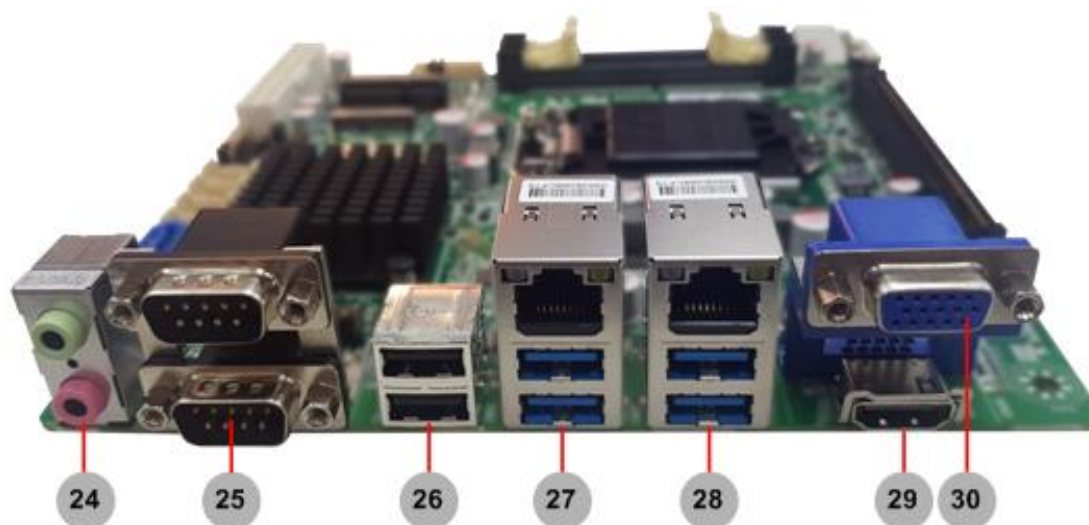

Jumpers/Headers/Connectors			
1	4-pin ATX Power Input Connector (CN16)	16	SATA 3.0 Connectors (CN7~CN8)
2	PCI-Express x16 Slot (CN15)	17	Front Audio Header (CN29)
3	LVDS Backlight PWM/DC Mode Select Jumper (JP8)	18	COM1 Data/Power Select Jumper (JP5)
4	DDR4 SO-DIMM Connectors (CN1, CN2)	19	COM1 RS-232/422/485 Mode Select Jumpers (JP4, JP6, JP7)
5	LVDS VDD Select Jumper (JP9)	20	M.2 Key E Connector (CN34)
6	LVDS Signal Header (CN31)	21	CPU Fan Connector (CN18)
7	LVDS Backlight Control Header (CN32)	22	System Fan Connector (CN19)
8	SIM Card Slot (CN5)	23	mSATA Connector (CN6)
9	GPIO Header (CN20)	24	Audio Jack (CN28)
10	24-pin ATX Power Input Connector (CN17)	25	COM1 and COM2 D-Sub Connector (CN21)
11	Case Open Select Jumper (JP10)	26	USB 2.0 Port (CN13)
12	Front Panel Header (CN12)	27	LAN1 and USB 3.0 Connector (CN26)
13	AT/ATX Power Mode Select Jumper (JP3)	28	LAN2 and USB 3.0 Connector (CN27)
14	COM3~COM6 Headers (CN22~CN23, CN36~CN37)	29	HDMI Connector (CN30)
15	Clear CMOS Jumper (JP1)	30	VGA Connector (CN35)



Note

To identify the first pin of a header or jumper, please refer to the following information:

- Usually, there is a thick line or a triangle near the header or jumper pin 1.

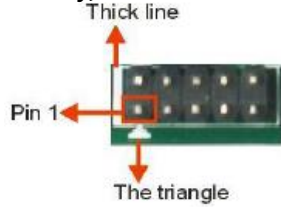

- Square pad, which you can find on the back of the motherboard, is usually used for pin 1.



2.3 Jumper Settings

Jumper is a small component consisting of jumper clip and jumper pins. Install jumper clip on 2 jumper pins to close. And remove jumper clip from 2 jumper pins to open. The following illustration shows how to set up jumper.

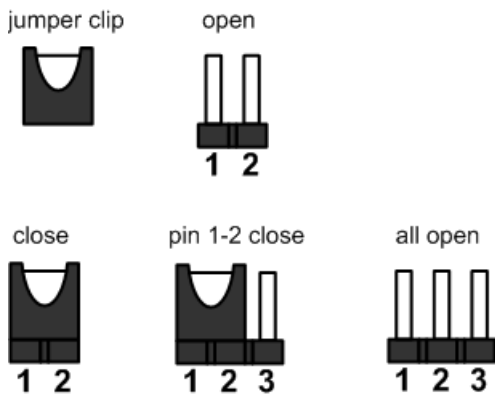

Before applying power to MANO522 Series, please make sure all of the jumpers are in factory default position. Below you can find a summary table of all jumpers and onboard default settings.



Note

Once the default jumper setting needs to be changed, please do it under power-off condition.

Jumper	Description	Setting
JP1	Clear CMOS Default: Normal Operation	1-2 Close
JP3	AT/ATX Power Mode Select Default: ATX Mode	1-2 Close
JP4	COM1 RS-232/422/485 Mode Select Default: RS-232	1-2 Close
JP6		3-5, 4-6 Close
JP7		3-5, 4-6 Close
JP5	COM1 Data/Power Select Default: RS-232 Data	COM1 Pin 1: DCD# 3-5 Close
		COM1 Pin 9: RI# 4-6 Close
JP8	LVDS Backlight PWM/DC Mode Select Default: PWM	1-2 Close
JP9	LVDS VDD Select Default: +3.3V	1-2 Close
JP10	Case Open Select Default: Close	1-2 Close

2.3.1 Clear CMOS (JP1)

This jumper allows you to clear the Real Time Clock (RTC) RAM in CMOS. You can clear the CMOS memory of date, time, and system setup parameters by erasing the CMOS RTC RAM data. The onboard button cell battery powers the RAM data in CMOS, which includes system setup information such as system passwords.

To erase the RTC RAM:

1. Turn OFF the computer and unplug the power cord.
2. Remove the onboard battery.
3. Move the jumper clip from pins 1-2 (default) to pins 2-3. Keep the clip on pins 2-3 for about 5~10 seconds, then move the clip back to pins 1-2.
4. Re-install the battery.
5. Plug the power cord and turn ON the computer.
6. Hold down the key during the boot process and enter BIOS setup to re-enter data.

Function	Setting
Normal operation (Default)	1-2 close
Clear CMOS	2-3 close



2.3.2 AT/ATX Power Mode Select (JP3)

This 3-pin (pitch=2.0mm) jumper allows you to select AT or ATX power mode.

Function	Setting
ATX mode (Default)	1-2 close
AT mode	2-3 close



2.3.3 COM1 RS-232/422/485 Mode Select (JP4, JP6, JP7)

These are 3x2-pin (pitch=2.0mm) jumpers for setting COM1 port to operate in RS-232, RS-422 or RS-485 communication mode.

Function	Setting
RS-232 mode (Default)	JP4 1-2 close JP6 3-5, 4-6 close JP7 3-5, 4-6 close
RS-422 mode	JP4 3-4 close JP6 1-3, 2-4 close JP7 1-3, 2-4 close
RS-485 mode	JP4 5-6 close JP6 1-3, 2-4 close JP7 1-3, 2-4 close

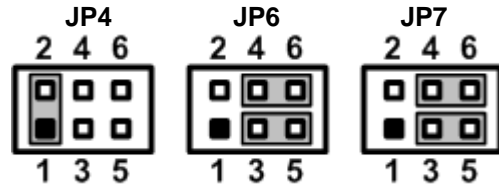

2.3.4 COM1 Data/Power Select (JP5)

This is a 3x2-pin (pitch=2.0mm) jumper. The COM1 port has +5V power capability on DCD and +12V on RI by setting JP5.

Function	Setting
Power: Set COM1 pin 1 to +5V	1-3 close
Data: Set COM1 pin 1 to DCD (Default)	3-5 close
Power: Set COM1 pin 9 to +12V	2-4 close
Data: Set COM1 pin 9 to RI (Default)	4-6 close

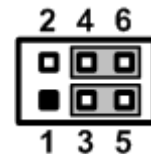

2.3.5 LVDS Backlight PWM/DC Mode Select (JP8)

This 3-pin (pitch=2.0mm) jumper enables you to select PWM or voltage control mode for LVDS backlight control header (CN32). These two control modes are for adjusting the brightness of LVDS panel.

Function	Setting
Controlled by PWM (Default)	1-2 close
Controlled by DC Voltage	2-3 close



2.3.6 LVDS VDD Select (JP9)

The motherboard supports voltage selection for flat panel displays. Use this 3x2-pin (pitch=2.54mm) jumper to set up VDD power of the LVDS connector. To prevent hardware damage, before connecting please make sure that the input voltage of LVDS panel is correct.

Function	Setting
+3.3V (Default)	1-2 close
+5V	3-4 close
+12V	5-6 close

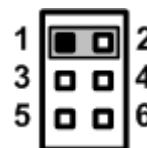

2.3.7 Case Open Select (JP10)

The motherboard has one 2-pin (pitch=2.54mm) jumper for chassis intrusion detection feature.

Function	Setting
Close (Default)	1-2 close
Active case open	1-2 open



2.4 Connectors

Signals go to other parts of the system through connectors. Loose or improper connection might cause problems, please make sure all connectors are properly and firmly connected. Here is a summary table showing connectors on the hardware.

Connector	Description
CN1	DIMM1: DDR4 SO-DIMM Connector
CN2	DIMM2: DDR4 SO-DIMM Connector
CN5	SIM Card Slot
CN6	mSATA Connector
CN7~CN8	SATA 3.0 Connectors
CN12	Front Panel Header
CN13	USB 2.0 port
CN15	PCI-Express x16 Slot
CN16~CN17	ATX Power Input Connectors
CN18~CN19	Fan Connectors
CN20	GPIO Header
CN21	COM1 and COM2 D-Sub Connector
CN22~CN23, CN36~CN37	COM3, COM4, COM5 and COM6 Headers
CN26~CN27	LAN and USB 3.0 Connectors
CN28	Audio Jack
CN29	Front Audio Header
CN30	HDMI Connector
CN31	LVDS Signal Header
CN32	LVDS Backlight Control Header
CN34	M.2 Key E Connector
CN35	VGA Connector

2.4.1 SIM Card Slot (CN5)

The CN5 is for inserting SIM Card which is mainly used in 3G/4G wireless network application. In order to work properly, the SIM Card must be used together with 3G/4G module which is inserted to CN6.

Pin	Signal	Pin	Signal
1	PWR_UIM	5	N/C
2	REST_UIM	6	DAT_UIM
3	CLK_UIM	7	VPP_UIM
4	N/C	8	GND

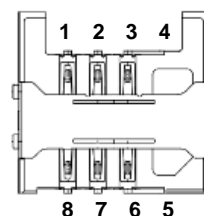

2.4.2 mSATA Connector (CN6)

Pin	Signal	Pin	Signal
1	N/C	2	+3.3VAUX
3	N/C	4	GND
5	N/C	6	+1.5V
7	N/C	8	UIM_PWR
9	GND	10	UIM_DAT
11	N/C	12	UIM_CLK
13	N/C	14	UIM_REST
15	GND	16	UIM_VPP
17	N/C	18	GND
19	N/C	20	N/C
21	GND	22	PERST#
23	SATA0_RX_DP	24	+3.3VAUX
25	SATA0_RX_DN	26	GND
27	GND	28	+1.5V
29	GND	30	SMB_CLK
31	SATA0_TX_DN	32	SMB_DATA
33	SATA0_TX_DP	34	GND
35	GND	36	USB#6_D-
37	GND	38	USB#6_D+
39	+3.3VAUX	40	GND
41	+3.3VAUX	42	N/C
43	GND	44	N/C
45	N/C	46	N/C
47	N/C	48	+1.5V
49	N/C	50	GND
51	N/C	52	+3.3VAUX

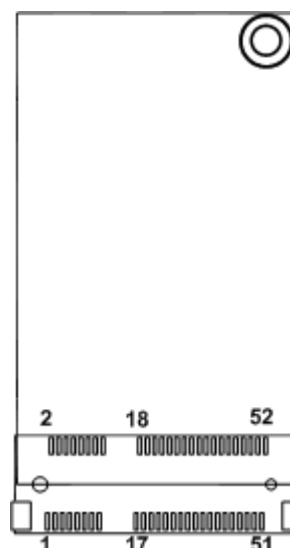

2.4.3 SATA 3.0 Connectors (CN7~CN8)

These Serial Advanced Technology Attachment (Serial ATA or SATA) connectors are for SATA 3.0 interfaces allowing up to 6.0Gb/s data transfer rate. They are computer bus interfaces for connecting to devices such as hard disk drives.

Pin	Signal
1	GND
2	SATA_TX+
3	SATA_TX-
4	GND
5	SATA_RX-
6	SATA_RX+
7	GND

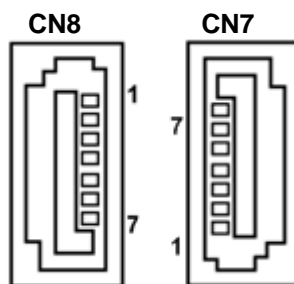

2.4.4 Front Panel Header (CN12)

The CN12 is a 7x2-pin (pitch=2.54mm) header for front panel interface.

Pin	Signal
1	Power LED+
2	SPK-
3	GND
4	BUZZER-
5	Power LED-
6	N/C
7	N/C
8	SPK+
9	PWR-
10	PWR+
11	RESET-
12	RESET+
13	HD LED-
14	HD LED+

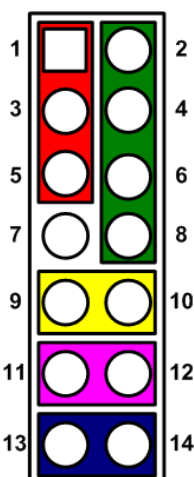

Power LED

Pin 1 connects anode(+) of LED and pin 5 connects cathode(-) of LED. The power LED lights up when the system is powered on.

External Speaker and Internal Buzzer

Pin 2, 4, 6 and 8 connect the case-mounted speaker unit or internal buzzer. While connecting the board to an internal buzzer, please set pin 2 and 4 closed; while connecting to an external speaker, you need to set pins 2 and 4 opened and connect the speaker cable to pin 8(+) and pin 2(-).

Power On/Off Button

Pin 9 and 10 connect the power button on front panel to the board, which allows users to turn on or off power supply.

System Reset Switch

Pin 11 and 12 connect the case-mounted reset switch that reboots your computer without turning off the power switch. It is a better way to reboot your system for a longer life of system power supply.

HDD Activity LED

This connection is linked to hard drive activity LED on the control panel. LED flashes when HDD is being accessed. Pin 13 and 14 connect the hard disk drive to the front panel HDD LED, pin 13 is assigned as cathode(-) and pin 14 is assigned as anode(+).

2.4.5 USB 2.0 Port (CN13)

The motherboard comes with one double-deck Universal Serial Bus (compliant with USB 2.0 (480Mbps)) connector on the rear I/O for installing USB peripherals such as keyboard, mouse, scanner, etc.

Pin	Signal	Pin	Signal
1	USB VCC (+5V level)	5	USB VCC (+5V level)
2	USB #1_D-	6	USB #8_D-
3	USB #1_D+	7	USB #8_D+
4	GND	8	GND

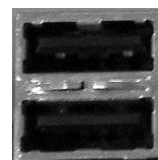
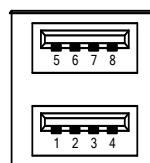

2.4.6 ATX Power Input Connectors (CN16 and CN17)

Steady and sufficient power can be supplied to all components on the board by connecting power connector. Please make sure all components and devices are properly installed before connecting the power connector.

External power supply plug fits into the connector in only one orientation. Properly press down power supply plug until it completely and firmly fits into this connector. Loose connection may cause system instability.

CN16 is a 4-pin connector for DC +12V power input.

Pin	Signal
1	GND
2	GND
3	+ 12V IN
4	+ 12V IN

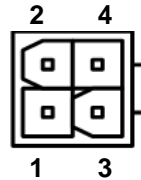

CN17 is a 24-pin connector for DC power input.

Pin	Signal	Pin	Signal
1	3.3V	13	3.3V
2	3.3V	14	-12V
3	GND	15	GND
4	+5V	16	PS_ON
5	GND	17	GND
6	+5V	18	GND
7	GND	19	GND
8	PWR OK	20	-5V
9	5VSB	21	+5V
10	+12V	22	+5V
11	+12V	23	+5V
12	3.3V	24	GND

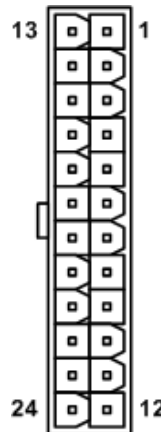

2.4.7 Fan Connectors (CN18 and CN19)

The motherboard has two fan connectors. You can find fan speed option within BIOS Setup Utility if fan is installed. For further information, see BIOS Setup Utility: Advanced\Hardware Monitor\PC Health Status in section 4.4.

CN18 (CPU fan, 4x1-pin pitch=2.54mm):

Pin	Signal
1	GND
2	+12V
3	FAN Speed Detection
4	FAN Speed Control

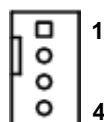

CN19 (System fan, 3x1-pin pitch=2.54mm):

Pin	Signal
1	GND
2	+12V
3	FAN Speed Detection

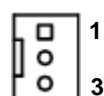

2.4.8 GPIO Header (CN20)

The CN20 is a 5x2-pin (pitch=2.00mm) header for digital I/O interface.

Pin	Signal	Pin	Signal
1	+5V	2	SIO_GPI70 (0xA06 Bit0, H)
3	SIO_GPO74 (0xA06 Bit4, H)	4	SIO_GPI71 (0xA06 Bit1, H)
5	SIO_GPO75 (0xA06 Bit5, H)	6	SIO_GPI72 (0xA06 Bit2, H)
7	SIO_GPO76 (0xA06 Bit6, H)	8	SIO_GPI73 (0xA06 Bit3, H)
9	SIO_GPO77 (0xA06 Bit7, H)	10	GND

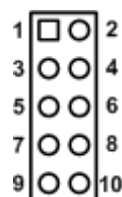

2.4.9 COM D-Sub Connector (CN21)

The CN21 is a double-deck D-Sub connector for COM1 and COM2 serial port interfaces where only COM1 is selectable for RS-232/422/485 mode by jumper settings (see section 2.3.3). The pin assignments of RS-232/422/485 are listed in table below.

COM1:

Pin	RS-232	RS-422	RS-485
1	DCD# ^[1]	TX-	485-
2	RXD	TX+	485+
3	TXD	RX+	N/C
4	DTR#	RX-	N/C
5	GND	GND	GND
6	DSR#	N/C	N/C
7	RTS#	N/C	N/C
8	CTS#	N/C	N/C
9	RI# ^{[1][2]}	N/C	N/C

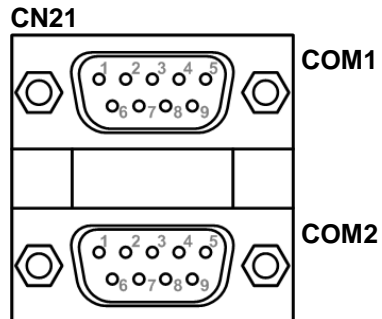

COM2:

Pin	Signal	Pin	Signal
1	DCD	2	RXD
3	TXD	4	DTR
5	GND	6	DSR
7	RTS	8	CTS
9	RI ^[1]		



Note

^[1]: Pin 1 of COM1 can be DCD/+5V and pin 9 of COM1 can be RI/+12V by selecting JP5 (see section 2.3.4).

^[2]: Pin RI on COM1 and COM2 do not support wake on ring.

2.4.10 COM Headers (CN22~CN23 and CN36~CN37)

The motherboard comes with four 5x2-pin (pitch=2.00mm) headers (CN22~CN23 for COM3~COM4, CN36~CN37 for COM5~COM6).

Pin	Signal	Pin	Signal
1	DCD	2	DSR
3	RXD	4	RTS
5	TXD	6	CTS
7	DTR	8	RI ^[1]
9	GND	10	N/C

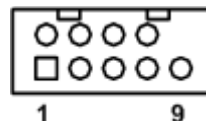

Note

^[1]: Pin RI on COM3, COM4, COM5 and COM6 do not support wake on ring.

2.4.11 LAN and USB 3.0 Connectors (CN26 and CN27)

The motherboard comes with two high performance plug and play Ethernet interfaces (RJ-45) which are fully compliant with the IEEE 802.3 standard. Connection can be established by plugging one end of the Ethernet cable into this RJ-45 connector and the other end to a 1000/100/10 Base-T hub.

The Universal Serial Bus (compliant with USB 3.0) connectors on the rear I/O are for installing USB peripherals such as keyboard, mouse, scanner, etc.

Pin	LAN Signal	Pin	LAN Signal
L1	Tx+ (Data transmission positive)	L2	Tx- (Data transmission negative)
L3	Rx+ (Data reception positive)	L4	RJ-1 (For 1000 Base-T only)
L5	RJ-1 (For 1000 Base-T only)	L6	Rx- (Data reception negative)
L7	RJ-1 (For 1000 Base-T only)	L8	RJ-1 (For 1000 Base-T only)
A	Speed LED	B	Active LED

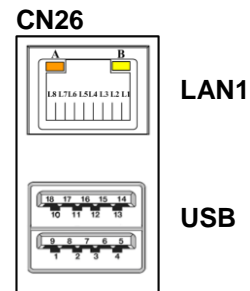

Note

- Speed LED turns orange for 1000Mbps or green for 100Mbps.
- CN26/CN27 supports Wake-on-LAN.

Pin	USB Signal	Pin	USB Signal
1	USB3_POWER	2	USB -
3	USB +	4	GND
5	USB3_SSRX	6	USB3_SSRX+
7	GND	8	USB3_SSTX
9	USB3_SSTX+		

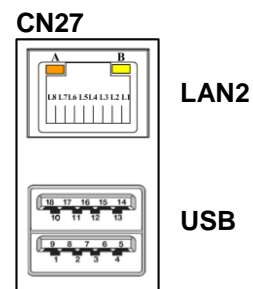

2.4.12 Audio Jack (CN28)

The motherboard provides HD audio jack on the rear I/O. Install audio driver, and then attach audio devices to CN28.

Pin Color	Signal
Green	Line-out
Pink	MIC-in



2.4.13 Front Audio Header (CN29)

This is a 5x2-pin (pitch=2.00mm) connector for convenient connection and control of audio devices.

Pin	Signal	Pin	Signal
1	MIC_IN	2	GND
3	LINE_IN_L	4	GND
5	LINE_IN_R	6	GND
7	AUD_OUT_L	8	GND
9	AUD_OUT_R	10	GND

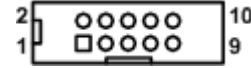

2.4.14 HDMI Connector (CN30)

The HDMI (High-Definition Multimedia Interface) is a compact digital interface which is capable of transmitting high-definition video and high-resolution audio over a single cable.

Pin	Signal	Pin	Signal
1	HDMI OUT_DATA2+	2	GND
3	HDMI OUT_DATA2-	4	HDMI OUT_DATA1+
5	GND	6	HDMI OUT_DATA1-
7	HDMI OUT_DATA0+	8	GND
9	HDMI OUT_DATA0-	10	HDMI OUT_Clock+
11	GND	12	HDMI OUT_Clock-
13	N/C	14	GND
15	HDMI OUT_SCL	16	HDMI OUT_SDA
17	GND	18	+5V
19	HDMI_HTPLG		

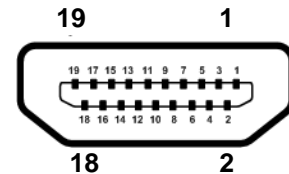

2.4.15 LVDS Signal Header (CN31)

This is a 2x20-pin (pitch=1.0mm) connector which is compliant with JST SM40B-SRDS-G-TF for LVDS LCD interface. It is strongly recommended to connect it with matching connector, SHDR-40VS-B.

Pin	Signal	Pin	Signal
1	VDD ^[*]	2	VDD ^[*]
3	VDD ^[*]	4	VDD ^[*]
5	VDD ^[*]	6	VDD ^[*]
7	N/C	8	N/C
9	GND(Detect) ^[**]	10	GND
11	LVDS_B_DATA3-	12	LVDS_B_DATA0-
13	LVDS_B_DATA3+	14	LVDS_B_DATA0+
15	GND	16	GND
17	LVDS_B_CLK-	18	LVDS_B_DATA1-
19	LVDS_B_CLK +	20	LVDS_B_DATA1+
21	GND	22	GND
23	LVDS_A_DATA0-	24	LVDS_B_DATA2-
25	LVDS_A_DATA0+	26	LVDS_B_DATA2+
27	GND	28	GND
29	LVDS_A_DATA1-	30	LVDS_A_DATA3-
31	LVDS_A_DATA1+	32	LVDS_A_DATA3+
33	LVDS_PRSENT#	34	GND
35	LVDS_A_DATA2-	36	LVDS_A_CLK-
37	LVDS_A_DATA2+	38	LVDS_A_CLK +
39	GND(Detect) ^[**]	40	GND

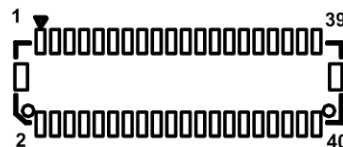

Note

^[*]: Panel power VDD is 3.3V by default, 5V or 12V is selectable by jumper JP9, see section 2.3.6.

^[**]: Grounding of this pin is required to ensure normal LVDS output.

2.4.16 LVDS Backlight Control Header (CN32)

This is an 8x1-pin (pitch=1.25mm) header which is compliant with Hirose DF13-8P-1.25V for inverter. We strongly recommend you to use the matching connector, DF13-8S-1.25C, to avoid malfunction.

Pin	Signal
1	+12V
2	+12V
3	+5V
4	LVDS_BKL_EN
5	GND
6	GND
7	GND
8	LVDS_BKL_CTL ^[1]



Note

^[1]: This signal is selectable by jumper JP8, see section 2.3.5.

2.4.17 M.2 Key E Connector (CN34)

The motherboard comes with one M.2 Key E connector (Wi-Fi & Bluetooth).

Pin	Signal	Pin	Signal	Pin	Signal
1	GND	26	N/C	51	GND
2	+3.3V	27	N/C	52	BUF_PLT_RST
3	USB#14_D+	28	N/C	53	NGFF_CLKREQ3
4	+3.3V	29	N/C	54	BT_KILL1
5	USB#14_D-	30	N/C	55	PCH_WAKE
6	N/C	31	N/C	56	WLAN_KILL1
7	GND	32	CNV_RGI_DT ^[1]	57	GND
8	N/C	33	GND	58	N/C
9	CNV_WR_1_DN ^[1]	34	CNV_RGI_RSP ^[1]	59	CNV_WT_1_DN ^[1]
10	PCM_CRF_RST ^[1]	35	PCIE12_TX_DP ^[1]	60	N/C
11	CNV_WR_1_DP ^[1]	36	CNV_BRI_DT ^[1]	61	CNV_WT_1_DP ^[1]
12	N/C	37	PCIE12_TX_DN	62	N/C
13	GND	38	CL_RST ^[1]	63	GND
14	PCMOUT_CLKREQ0 ^[1]	39	GND	64	M2_REFCLK
15	CNV_WR_0_DN ^[1]	40	CL_DATA ^[1]	65	CNV_WT_0_DN ^[1]
16	N/C	41	PCIE12_RX_DP	66	N/C
17	CNV_WR_0_DP ^[1]	42	CL_CLK ^[1]	67	CNV_WT_0_DP ^[1]
18	GND	43	PCIE12_RX_DN	68	N/C
19	GND	44	CNV_PA_BLANKING ^[1]	69	GND
20	UART_BT_WAKE ^[1]	45	GND	70	N/C
21	CNV_WR_CLK_DN ^[1]	46	CNV_MFUART2_TXD ^[1]	71	CNV_WT_CLK_DN ^[1]
22	CNV_BRI_RSP ^[1]	47	CLKOUT_PCIE_P3	72	+3.3V
23	CNV_WR_CLK_DP ^[1]	48	CNV_MFUART2_RXD ^[1]	73	CNV_WT_CLK_DP ^[1]
24	N/C	49	CLKOUT_PCIE_N3	74	+3.3V
25	N/C	50	PCH_SUSCLK	75	GND

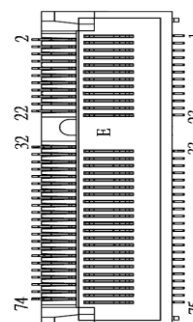

Note

^[1]: These pins are for CNVI module.

2.4.18 VGA Connector (CN35)

The CN35 is a high rise 15-pin D-Sub connector which is commonly used for VGA display. This VGA interface configuration can be configured via software utility.

Pin	Signal	Pin	Signal
1	Red	2	Green
3	Blue	4	NC
5	GND	6	DETECT
7	GND	8	GND
9	VCC	10	GND
11	NC	12	DDC DATA
13	Horizontal Sync	14	Vertical Sync
15	DDC CLK		

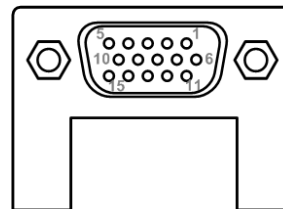

This page is intentionally left blank.

Section 3

Hardware Description

3.1 Microprocessors

The MANO522 Series supports Intel® Core™ i7/ i5/ i3 and Pentium® processors, which enable your system to operate under Windows® 10 and Linux environments. The system performance depends on the microprocessor. Make sure all correct settings are arranged for your installed microprocessor to prevent the CPU from damages.

3.2 BIOS

The MANO522 Series uses AMI Plug and Play BIOS with a single SPI Flash.

3.3 System Memory

The MANO522 supports two 260-pin DDR4 SO-DIMM sockets for maximum memory capacity up to 64GB DDR4 SDRAMs. The memory module comes in sizes of 2GB, 4GB, 8GB, 16GB and 32GB.



Note

- ***For single memory channel configuration, install memory module in channel 0 (CN1) DDR4 SO-DIMM socket.***
- ***For dual memory channel configuration, install memory modules of the same size, chip width, density and rank in both channel 0 (CN1) and channel 1 (CN2) DDR4 SO-DIMM sockets.***

This page is intentionally left blank.

Section 4

AMI BIOS Setup Utility

The AMI UEFI BIOS provides users with a built-in setup program to modify basic system configuration. All configured parameters are stored in a flash chip to save the setup information whenever the power is turned off. This chapter provides users with detailed description about how to set up basic system configuration through the AMI BIOS setup utility.

4.1 Starting

To enter the setup screens, follow the steps below:

1. Turn on the computer and press during the Power On Self Test (POST) to enter BIOS setup, otherwise, POST will continue with its test routines.
2. Once you enter the BIOS, the main BIOS setup menu displays. You can access the other setup screens from the main BIOS setup menu, such as the Advanced and Chipset menus.



Note

If your computer cannot boot after making and saving system changes with BIOS setup, you can restore BIOS optimal defaults by setting JP1 (see section 2.3.1).

It is strongly recommended that you should avoid changing the chipset's defaults. Both AMI and your system manufacturer have carefully set up these defaults that provide the best performance and reliability.

4.2 Navigation Keys

The BIOS setup/utility uses a key-based navigation system called hot keys. Most of the BIOS setup utility hot keys can be used at any time during the setup navigation process. These keys include <F1>, <F2>, <Enter>, <ESC>, <Arrow> keys, and so on.



Note

Some of the navigation keys differ from one screen to another.

Hot Keys	Description
→← Left/Right	The Left and Right <Arrow> keys allow you to select a setup screen.
↑↓ Up/Down	The Up and Down <Arrow> keys allow you to select a setup screen or sub screen.
Enter	The <Enter> key allows you to display or change the setup option listed for a particular setup item. The <Enter> key can also allow you to display the setup sub screens.
+– Plus/Minus	The Plus and Minus <Arrow> keys allow you to change the field value of a particular setup item.
F1	The <F1> key allows you to display the General Help screen.
F2	The <F2> key allows you to Load Previous Values.
F3	The <F3> key allows you to Load Optimized Defaults.
F4	The <F4> key allows you to save any changes you have made and exit Setup. Press the <F4> key to save your changes.
Esc	The <Esc> key allows you to discard any changes you have made and exit the Setup. Press the <Esc> key to exit the setup without saving your changes.

4.3 Main Menu

When you first enter the setup utility, you will enter the Main setup screen. You can always return to the Main setup screen by selecting the Main tab. System Time/Date can be set up as described below. The Main BIOS setup screen is shown below.

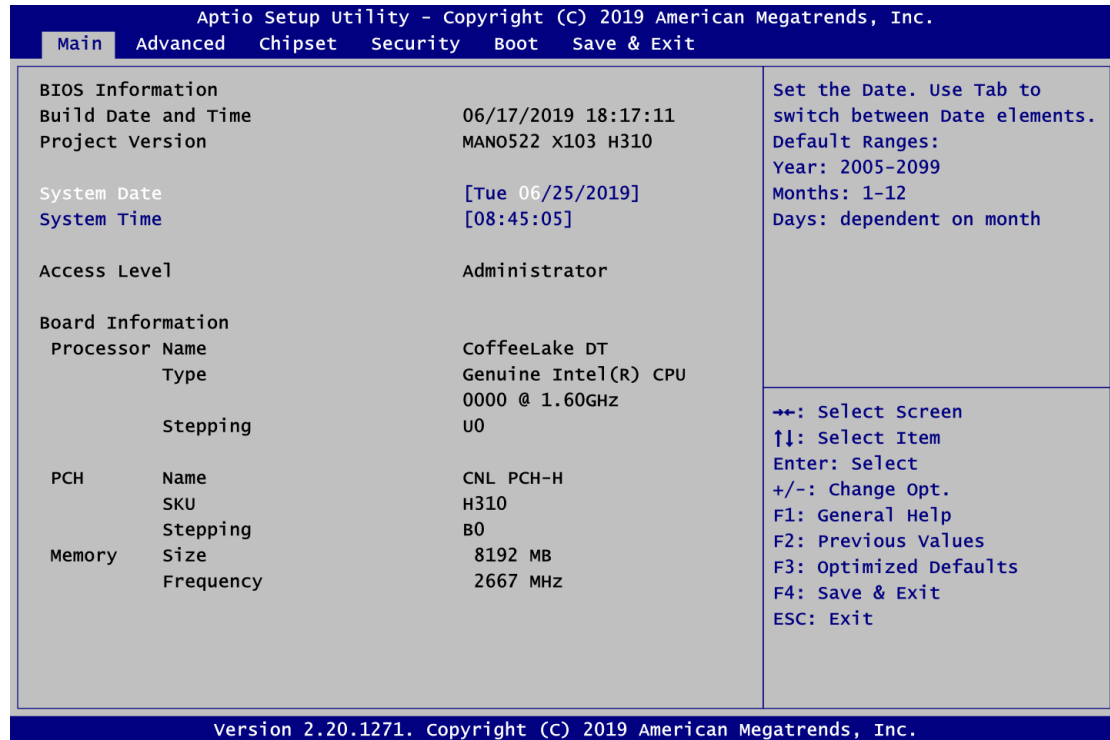

BIOS Information

Display the BIOS information.

System Date/Time

Use this option to change the system time and date. Highlight System Time or System Date using the <Arrow> keys. Enter new values through the keyboard. Press the <Tab> key or the <Arrow> keys to move between fields. The date must be entered in MM/DD/YY format. The time is entered in HH:MM:SS format.

Access Level

Display the access level of current user.

Board Information

Display the board information.

4.4 Advanced Menu

The Advanced menu also allows users to set configuration of the CPU and other system devices. You can select any of the items in the left frame of the screen to go to the sub menus:

- ▶ IT8786 Super IO Configuration
- ▶ Hardware Monitor
- ▶ Smart Fan Function
- ▶ Trusted Computing
- ▶ S5 RTC Wake Settings
- ▶ ACPI Settings
- ▶ CPU Configuration
- ▶ SATA And RST Configuration
- ▶ PCH-FW Configuration
- ▶ USB Configuration

For items marked with “▶”, please press <Enter> for more options.

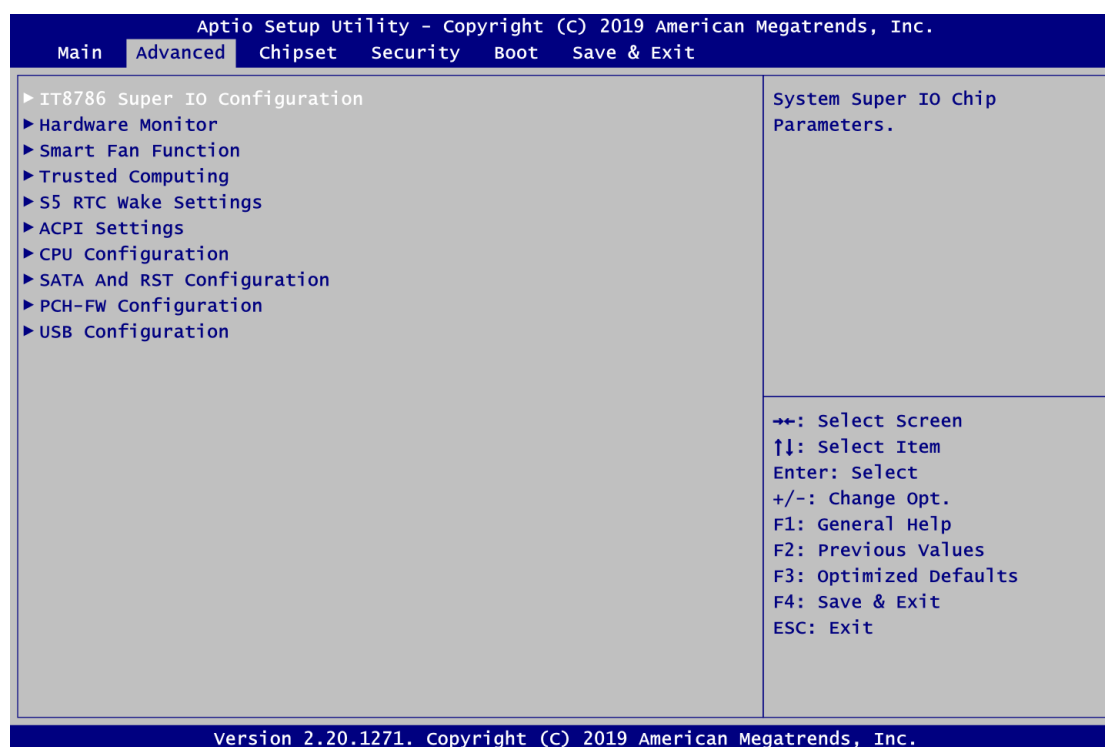

- **IT8786 Super IO Configuration**

You can use this screen to select options for the Super IO Configuration, and change the value of the selected option. A description of the selected item appears on the right side of the screen. For items marked with "▶", please press <Enter> for more options.

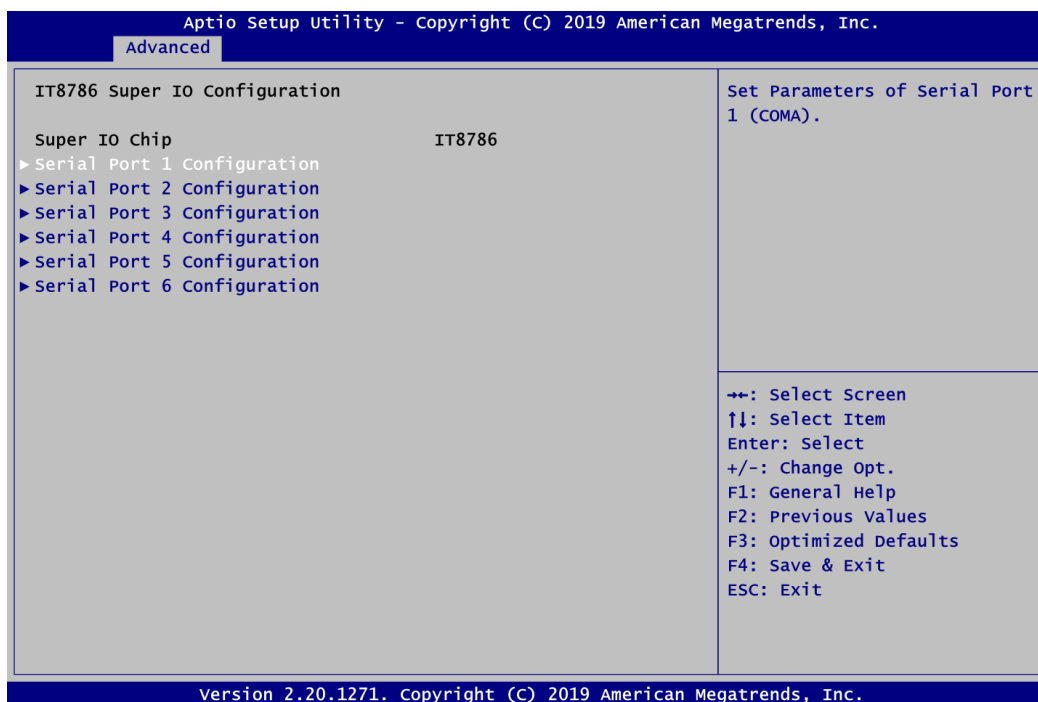

Serial Port 1~6 Configuration

Use these items to set parameters related to serial port 1~6.

- **Serial Port 1~6 Configuration**

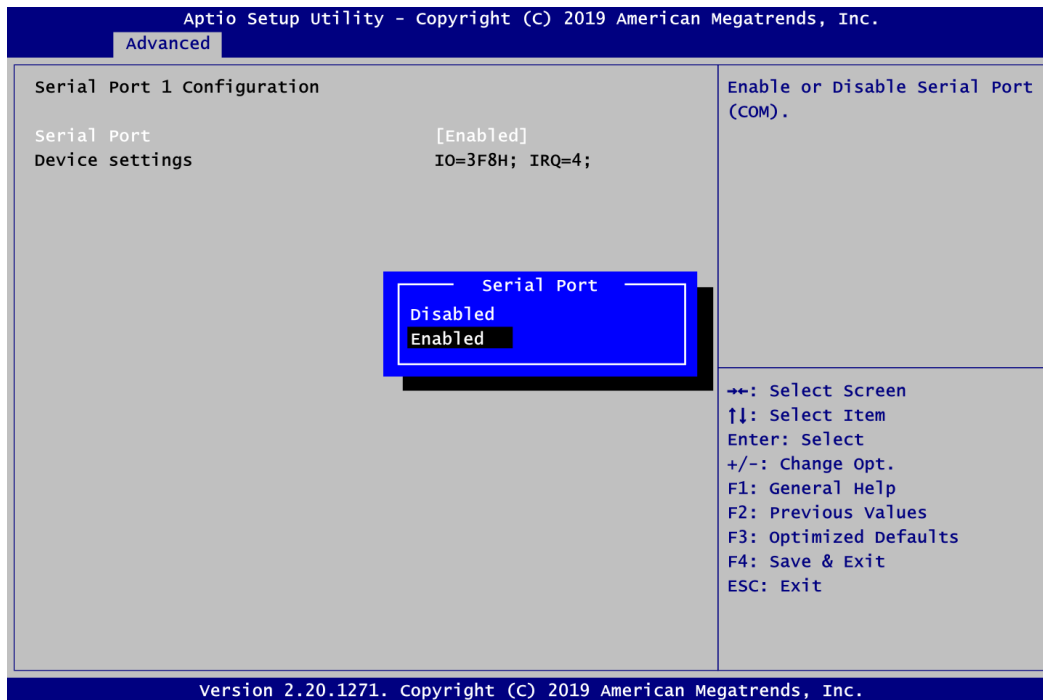

Serial Port

Enable or disable serial port 1~6. The optimal settings for base I/O address and for interrupt request address are:

- Serial port 1: 3F8h, IRQ4
- Serial port 2: 2F8h, IRQ3
- Serial port 3: 3E8h, IRQ7
- Serial port 4: 2E8h, IRQ6
- Serial port 5: 2F0h, IRQ6
- Serial port 6: 2E0h, IRQ7

- **Hardware Monitor**

This screen monitors hardware health status.

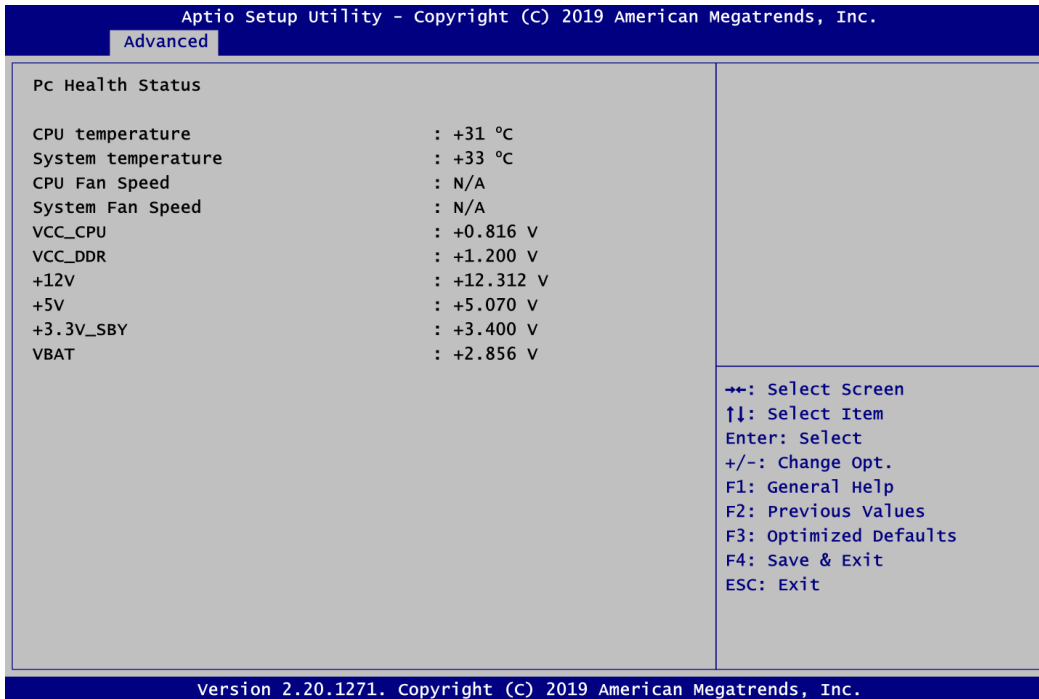

This screen displays the temperature of system and CPU, cooling fans speed in RPM and system voltages (VCC_CPU, VCC_DDR, +12V, +5V, +3.3V standby and VBAT).

● **Smart Fan Function**

This screen allows you to select CPU fan and system fan mode.

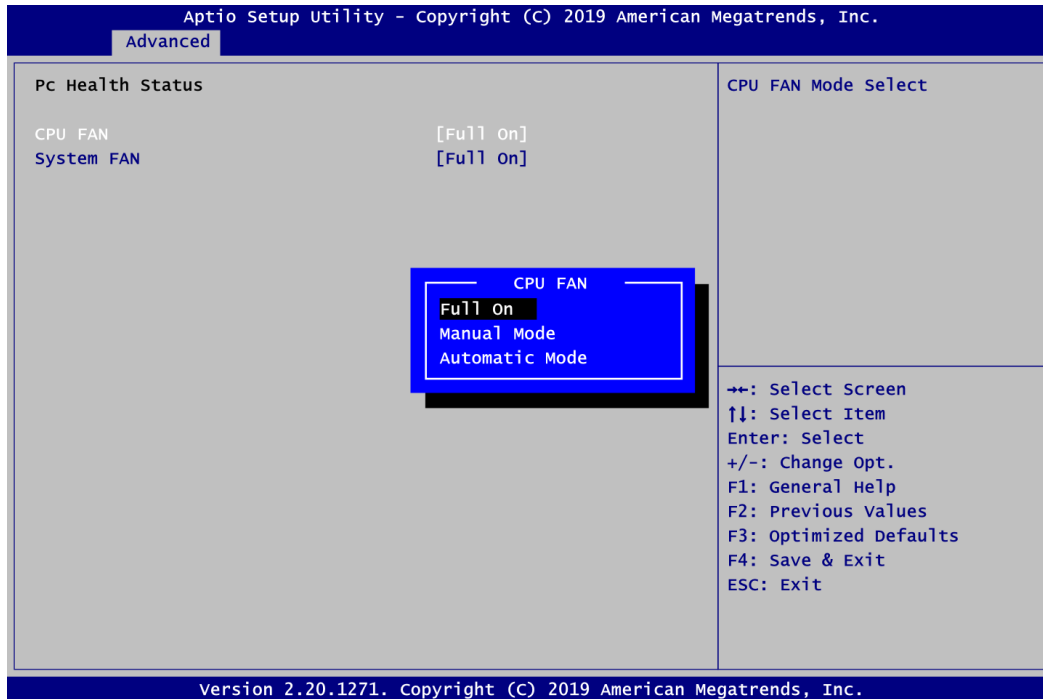

CPU FAN\System FAN

This item allows you to select the fan speed option(s) of CPU fan and system fan (see section 2.4.7) which can be set to Full on, Manual and Automatic Mode.

- Full On: The fan always runs at full speed.
- Manual Mode: Use the start PWM value to set fan speed manually. The range is from 0 to 255.

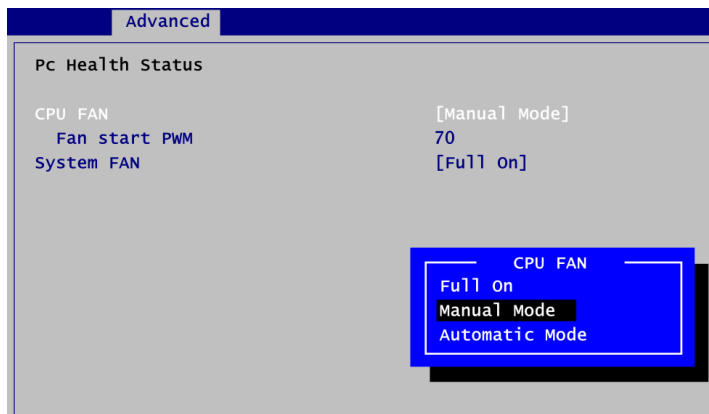

- Automatic Mode: The following selections appear only in Automatic Mode. The initial spinning speed of fan is determined according to start PWM value. The PWM Slope is used to control how fast the fan speeds up or slows down; larger value means faster. When temperature gets higher, the fan increases its speed according to PWM Slope.

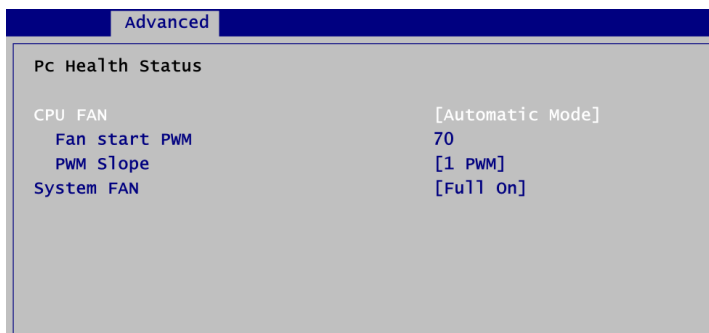

● **Trusted Computing**

This screen provides function for specifying the TPM settings.

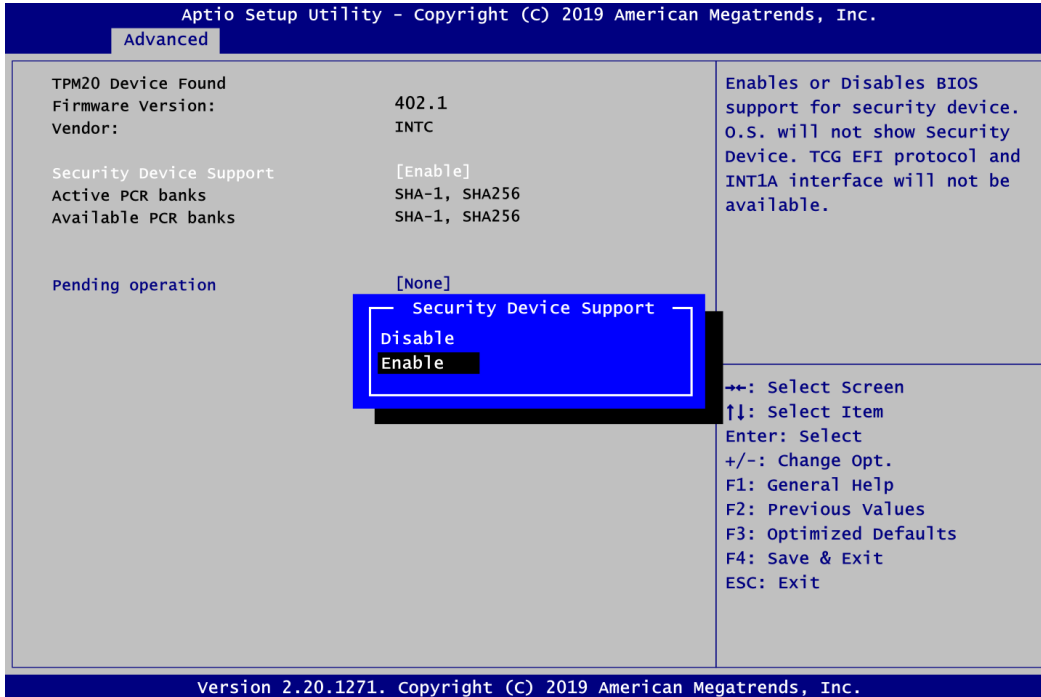

Security Device Support

Enable or disable BIOS support for security device, see image below. OS will not show security device. TCG EFI protocol and INT1A interface will not be available.

Pending operation

Schedule an operation for the security device, see image below.

- None
- TPM Clear: Clear all data secured by TPM.

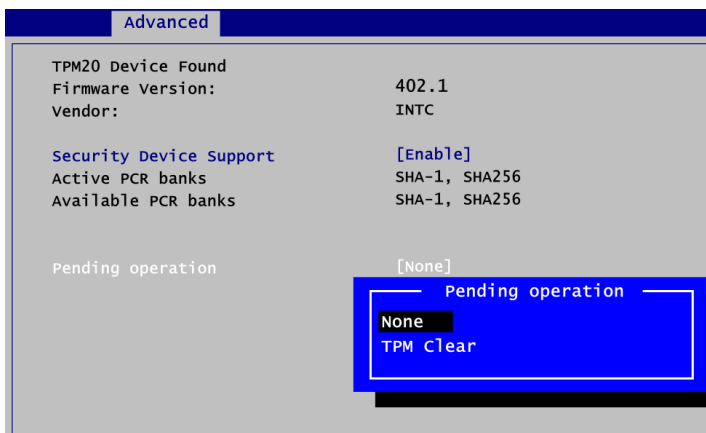

● **S5 RTC Wake Settings**

This screen allows user to enable system to wake from S5 using RTC alarm.

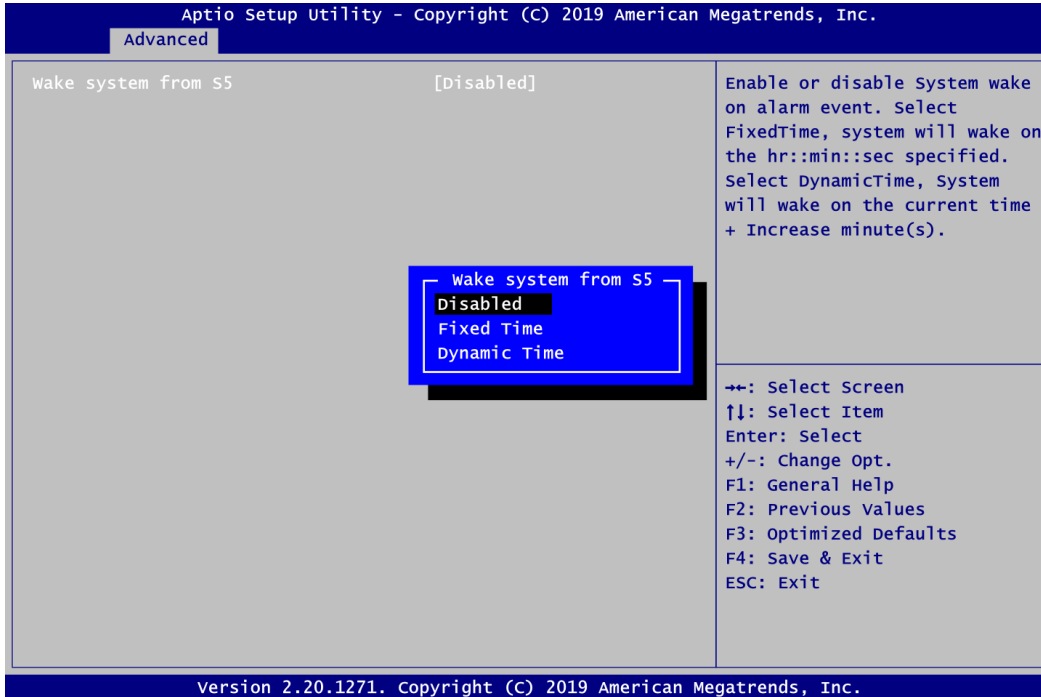

Wake system from S5

Enable or disable system wake on alarm event. It allows you to wake up the system in a certain time. Select Fixed Time to set the system to wake on the specified time, see image below. Use ↑ ↓ to switch among the items: Hour, Minute and Second, and type the value in the selected item as you wish. For example, if you want the system to boot up automatically at 12:15:36, then you should enter 12, 15, and 36 from top to bottom.

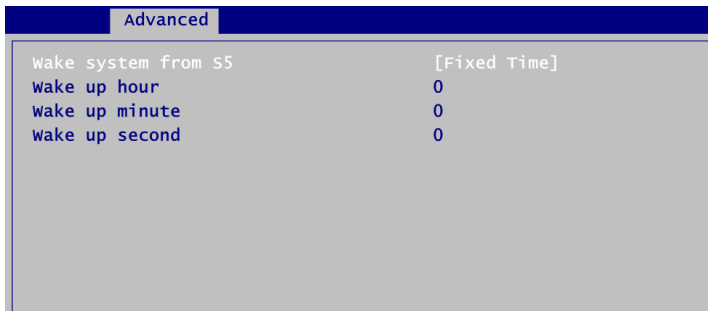

Select Dynamic Time, system will wake on the current time + increase minute(s).

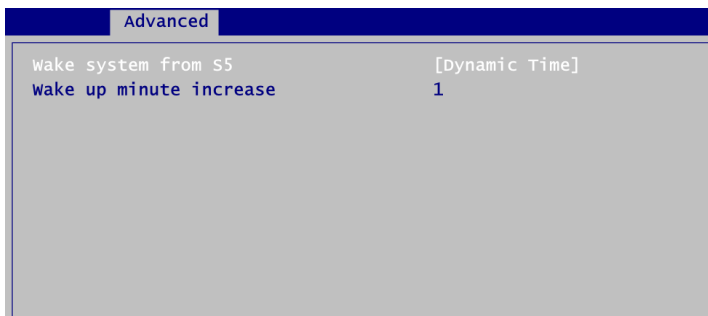

- **ACPI Settings**

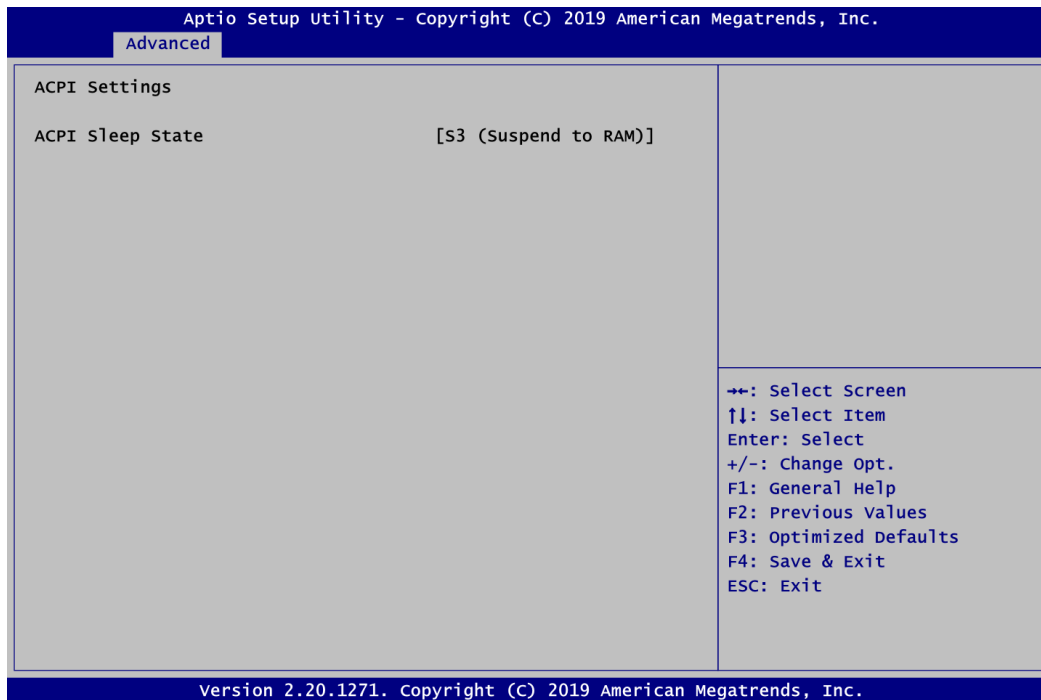

ACPI Sleep State

When the suspend button is pressed, the ACPI (Advanced Configuration and Power Interface) sleep state is S3 (Suspend to RAM).

- **CPU Configuration**

This screen shows CPU information, and you can change the value of the selected option.

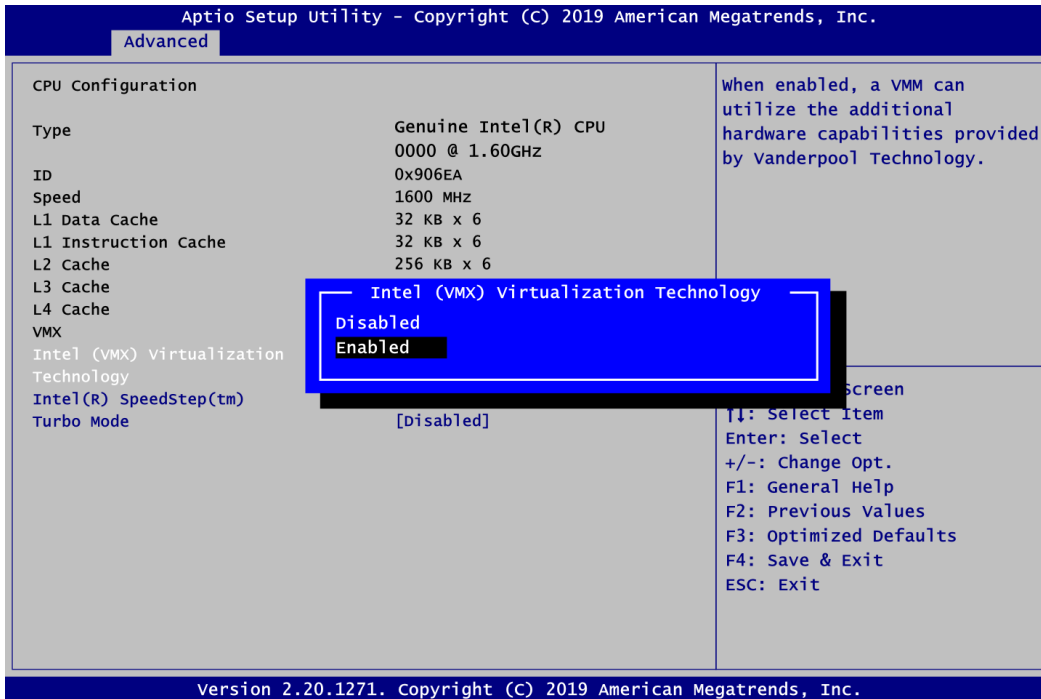

Intel (VMX) Virtualization Technology

Enable or disable Intel Virtualization Technology. When enabled, a VMM (Virtual Machine Mode) can utilize the additional hardware capabilities. It allows a platform to run multiple operating systems and applications independently, hence enabling a single computer system to work as several virtual systems.

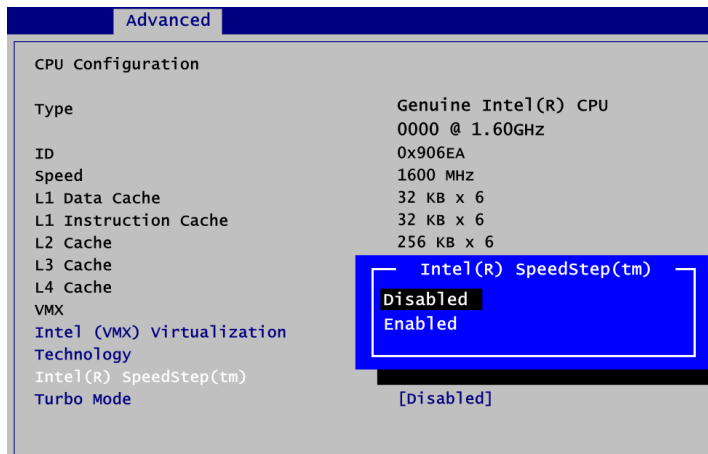

Intel(R) SpeedStep(tm)

The processor will control the frequency dynamically.

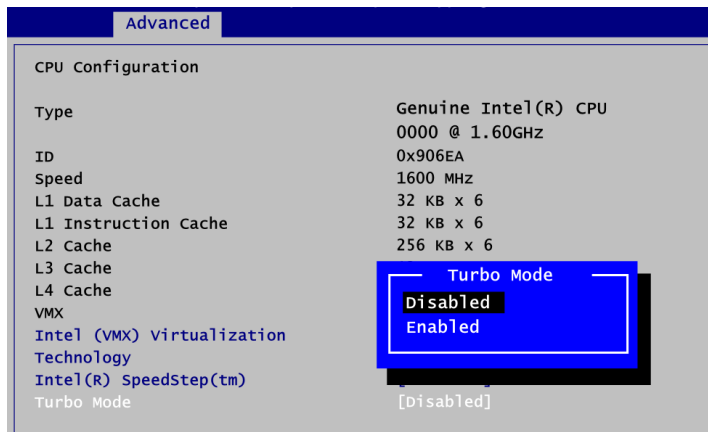

Turbo Mode

Enable or disable processor Turbo Mode. The processor can run up to maximum turbo frequency when the system loading becomes higher.

- **SATA and RST Configuration**

During system boot up, BIOS automatically detects the presence of SATA devices. In the SATA Configuration menu, you can see the hardware currently installed in SATA ports.

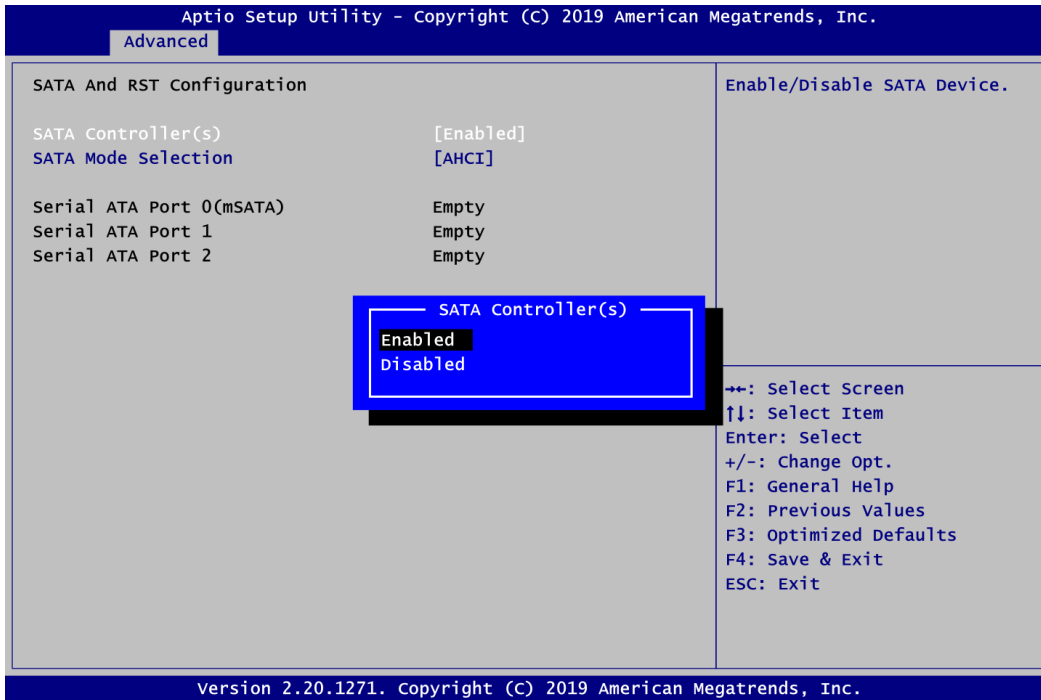

SATA Controller(s)

Enable or disable the SATA Controller feature. The default is Enabled.

SATA Mode Selection

The SATA operation mode is AHCI (Advanced Host Controller Interface).

- **PCH-FW Configuration**

This screen displays ME Firmware information.

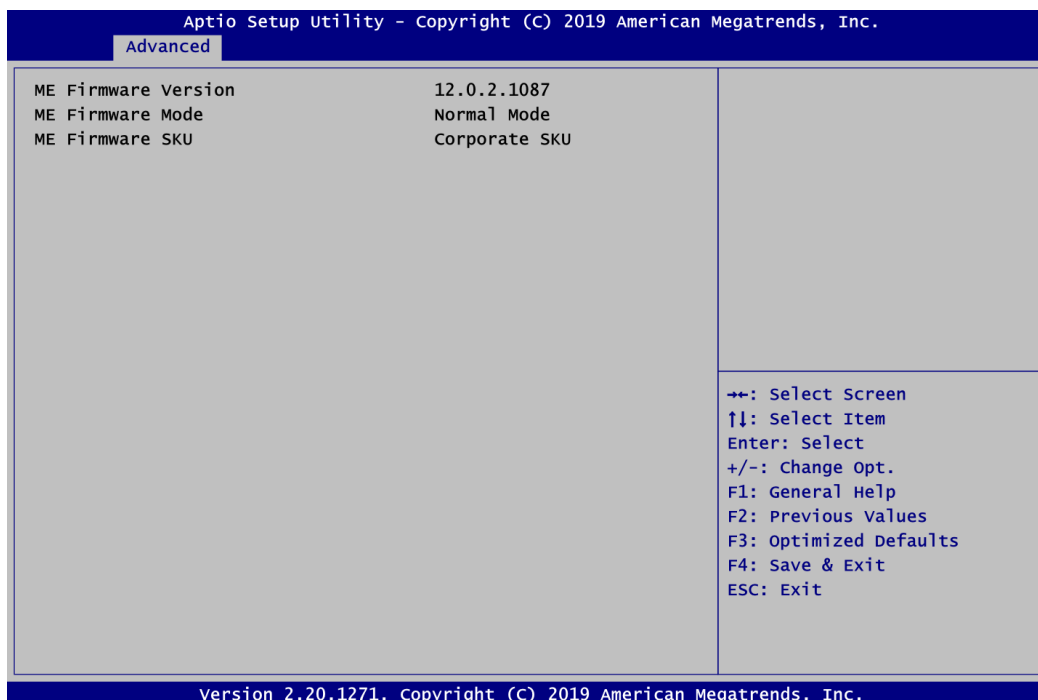

- **USB Configuration**

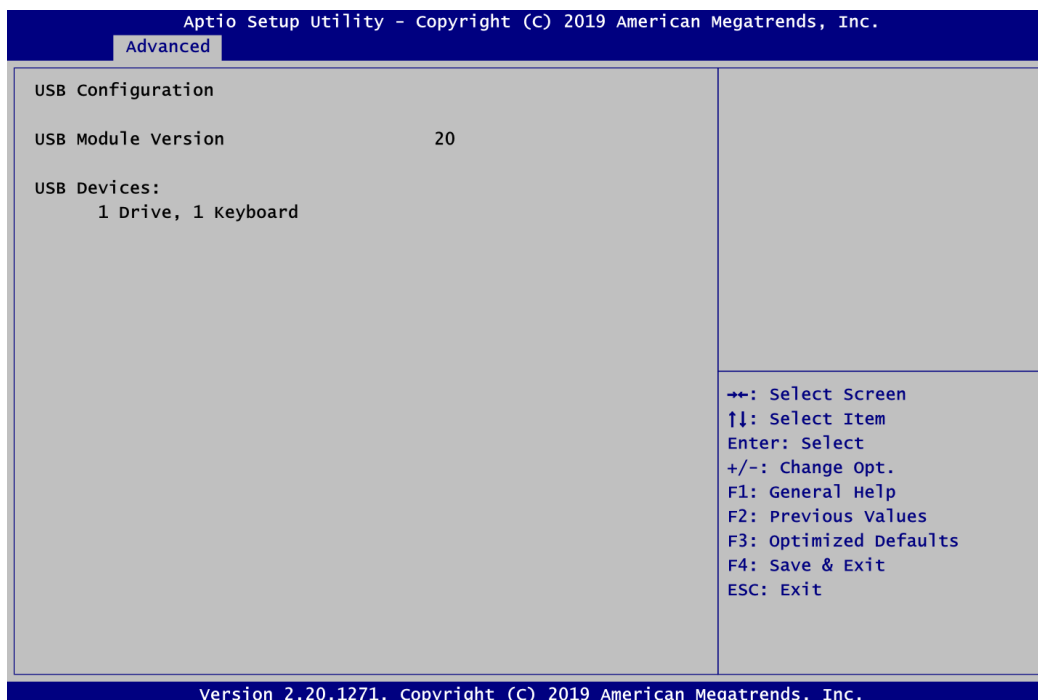

USB Devices

Display all detected USB devices.

4.5 Chipset Menu

The Chipset menu allows users to change the advanced chipset settings. You can select any of the items in the left frame of the screen to go to the sub menus:

- ▶ System Agent (SA) Configuration
- ▶ PCH-IO Configuration

For items marked with “▶”, please press <Enter> for more options.

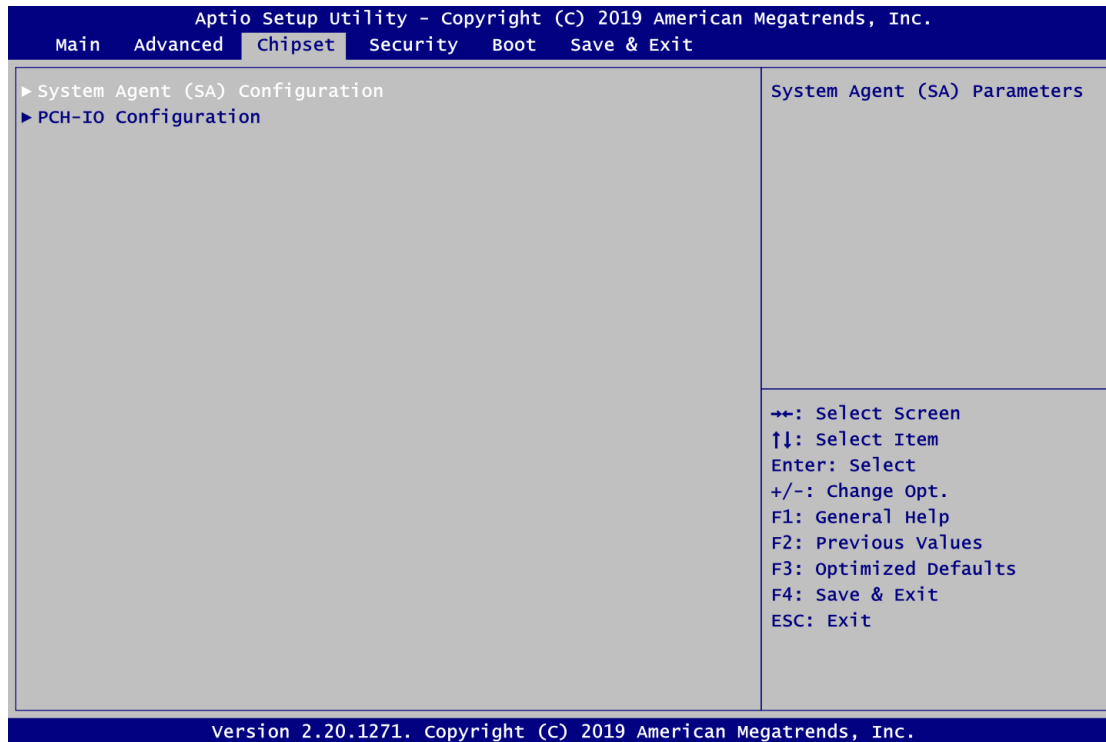

- **System Agent (SA) Configuration**

This screen allows users to configure System Agent (SA) parameters. For items marked with “▶”, please press <Enter> for more options.

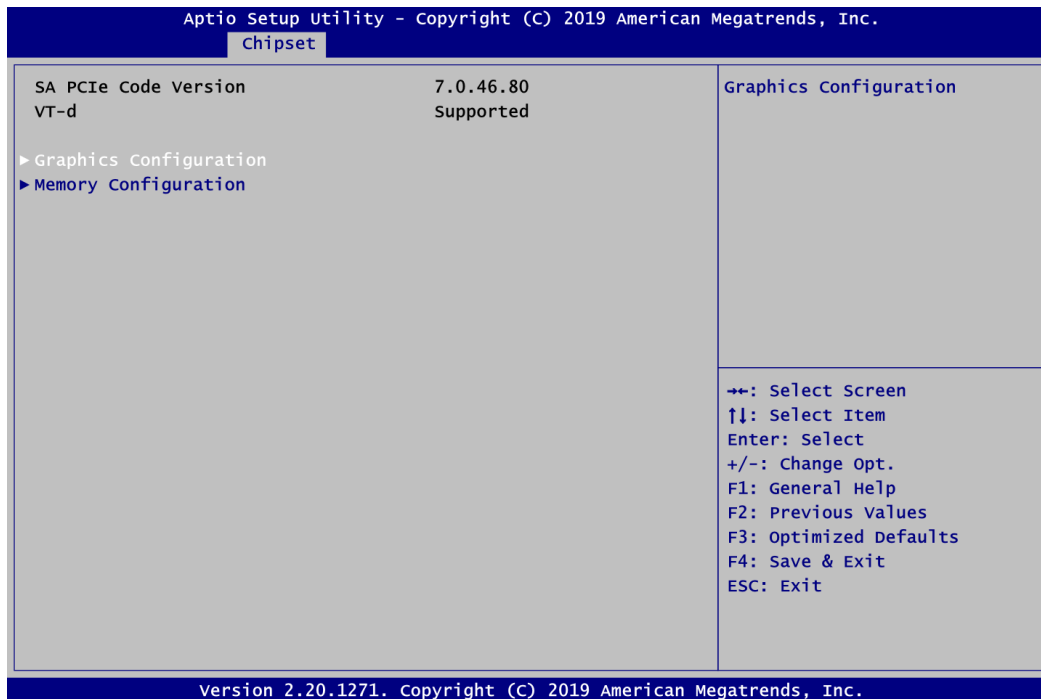

Graphics Configuration

Open sub menu for parameters related to graphics configuration.

Memory Configuration

Open sub menu for information related to system memory.

● **Graphics Configuration**

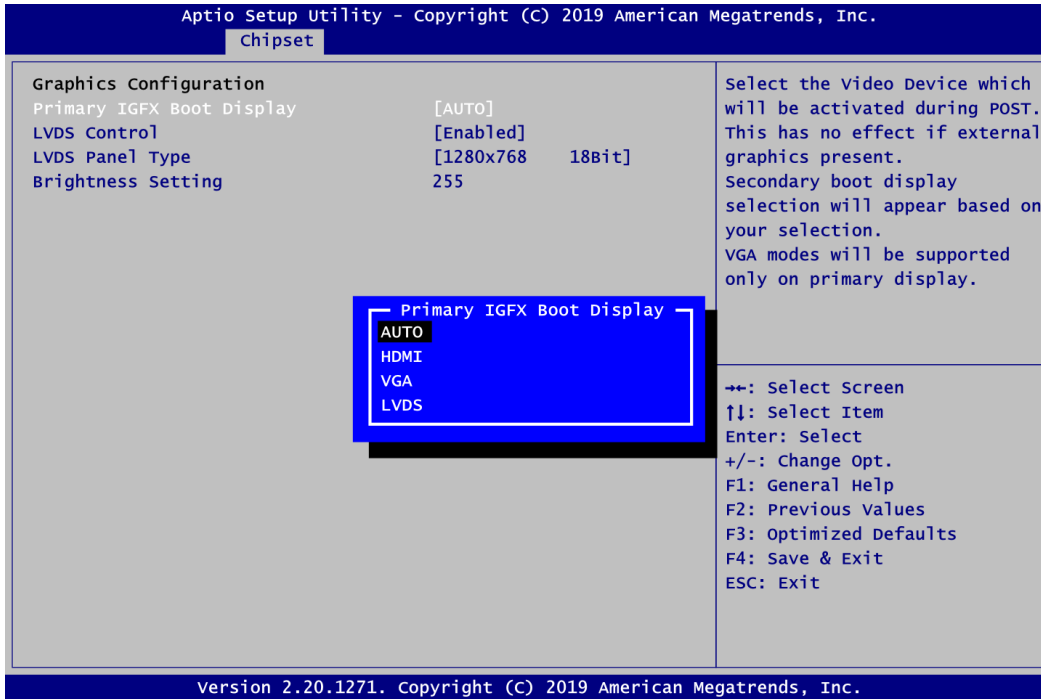

Primary IGFX Boot Display

Select the video device which will be activated during POST (Power-On Self Test). The default is Auto. The secondary boot display selection will appear based on your selection.

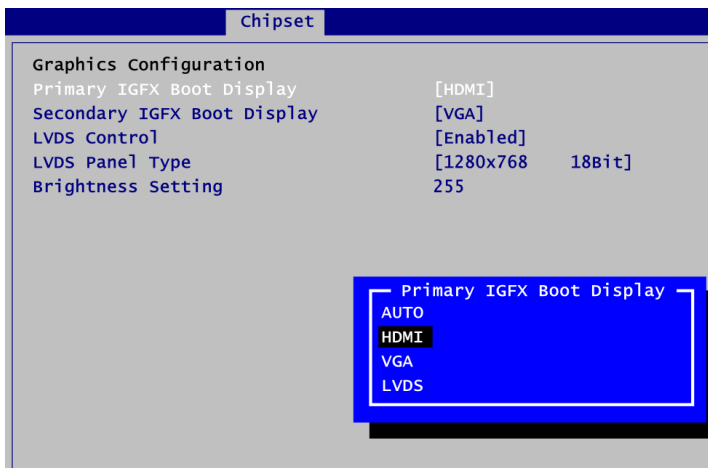

Secondary IGFX Boot Display

After selecting other than “AUTO” on “Primary IGFX Boot Display”, the Secondary IGFX Boot Display will show up and the options are Disabled, HDMI and VGA.

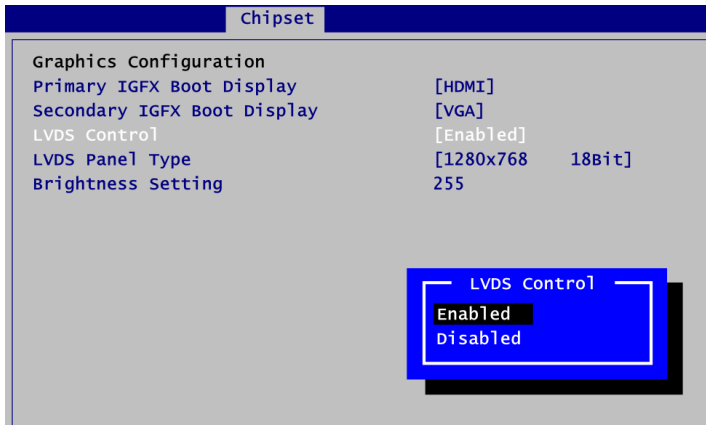

LVDS Control

Enable or disable LVDS Control. When installing Linux OS and if HDMI or VGA display is connected to your system, make sure to set this option to Disabled.

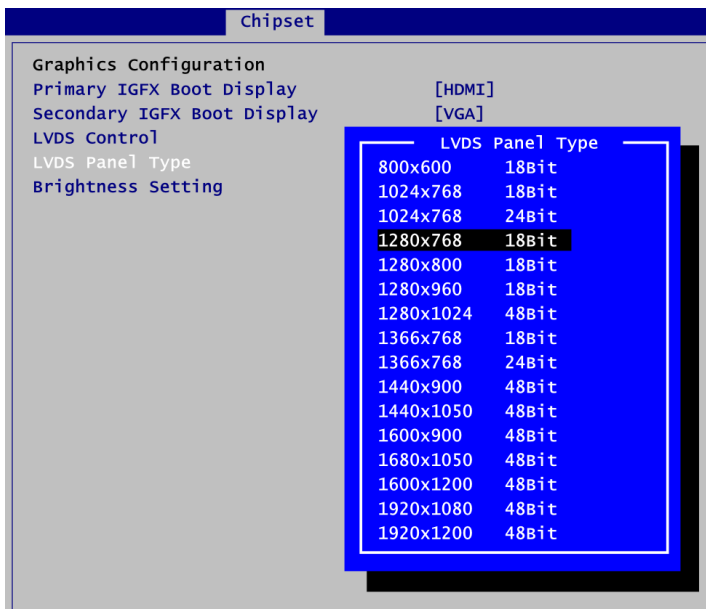

LVDS Panel Type

Select the appropriate LVDS panel resolution; see the selection options in image above.

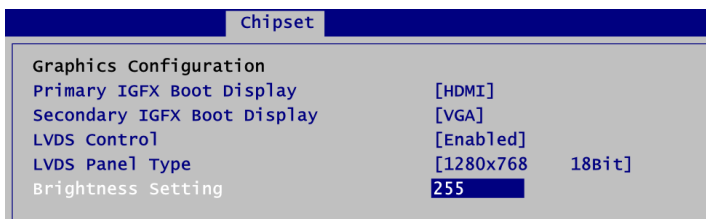

Brightness Setting

This option appears only when LVDS panel is connected. It allows user to adjust the brightness level of the LVDS panel.

- Range: 0~255
- Default: 255

- **Memory Configuration**

This screen shows the system memory information.

Aptio Setup Utility - Copyright (C) 2019 American Megatrends, Inc.	
Chipset	
Memory Configuration	
Memory RC Version	0.7.1.65
Memory Size	4096 MB
Channel 0 Slot 0	Populated & Enabled
Size	4096 MB (DDR4)
Number of Ranks	1
Manufacturer	Kingston
Channel 1 Slot 0	Not Populated / Disabled
++: Select Screen ↑↓: Select Item Enter: Select +/-: Change Opt. F1: General Help F2: Previous Values F3: Optimized Defaults F4: Save & Exit ESC: Exit	
Version 2.20.1271. Copyright (C) 2019 American Megatrends, Inc.	

- **PCH-IO Configuration**

This screen allows you to set PCH parameters.

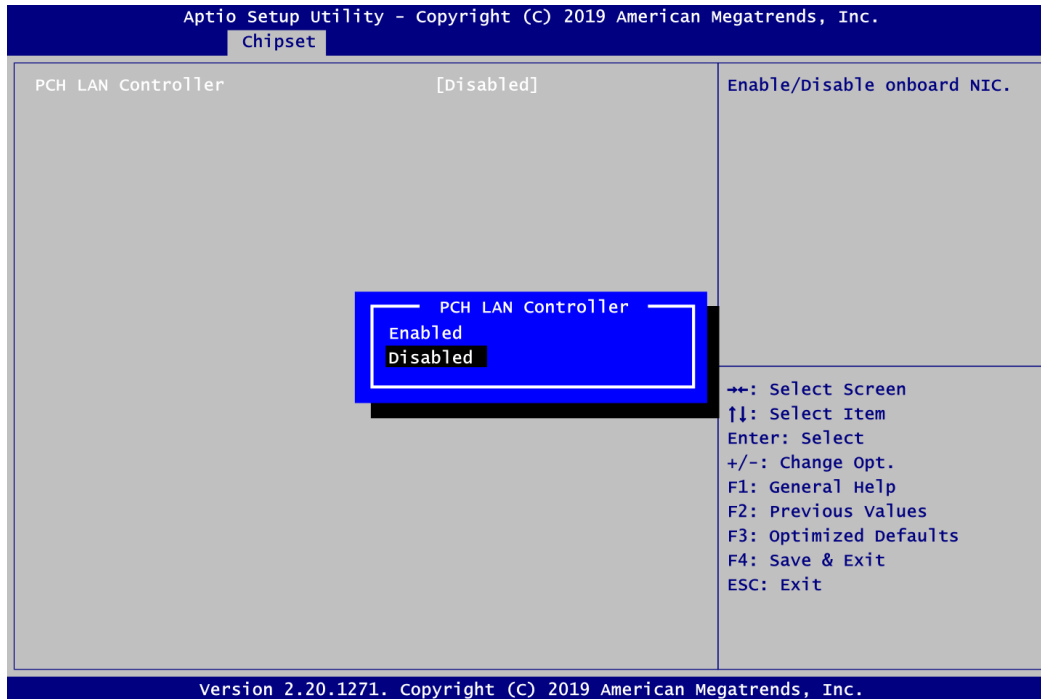

PCH LAN Controller

Enable or disable onboard PCH LAN controller.

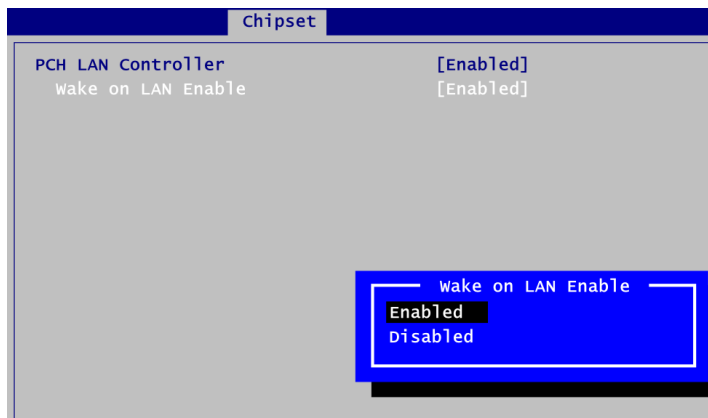

Wake on LAN

After enabling PCH LAN Controller, enabling or disabling integrated LAN to wake the system.

4.6 Security Menu

The Security menu allows users to change the security settings for the system.



- **Setup Administrator Password**
Set setup administrator password.
- **User Password**
Set user password.

4.7 Boot Menu

The Boot menu allows users to change boot options of the system.

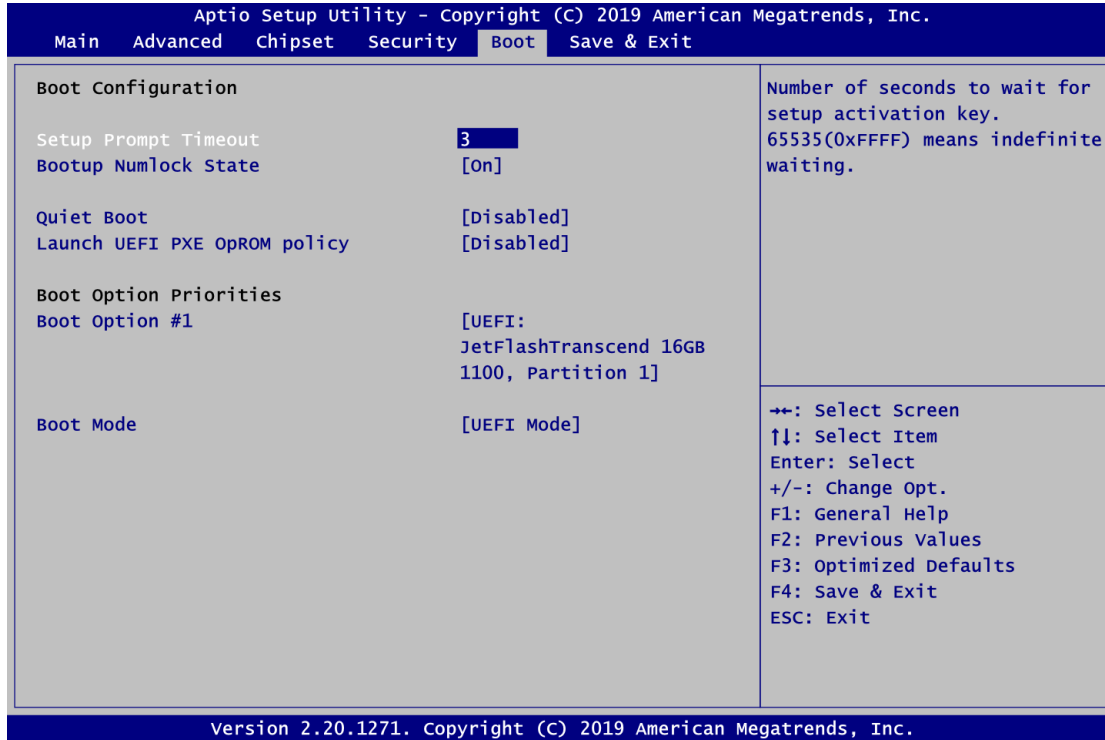

- **Setup Prompt Timeout**
Number of seconds to wait for setup activation key. 65535(0xFFFF) means indefinite waiting.
- **Bootup NumLock State**
Use this item to select the power-on state for the keyboard NumLock.
- **Quiet Boot**
Select to display either POST output messages or a splash screen during boot-up.

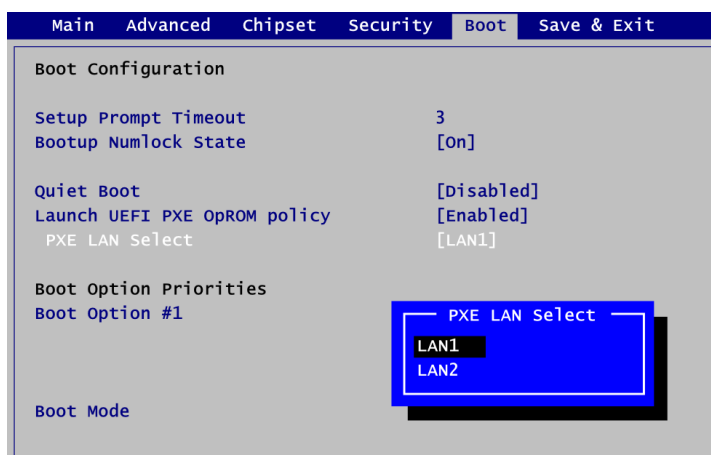

- **Launch UEFI PXE OpROM policy**
Control the execution of UEFI PXE OpROM. When enabled, you may select LAN1 or LAN2 as PXE LAN port.
- **Boot Option Priorities**
These are settings for boot priority. Specify the boot device priority sequence from the available devices.
- **Boot Mode**
Use this option for boot mode settings.
 - UEFI Boot: Select support to boot any UEFI-capable OS.
 - Legacy Boot: Select support to boot non UEFI-capable OS that expects a legacy BIOS interface.

4.8 Save & Exit Menu

The Save & Exit menu allows users to load your system configuration with optimal or fail-safe default values.

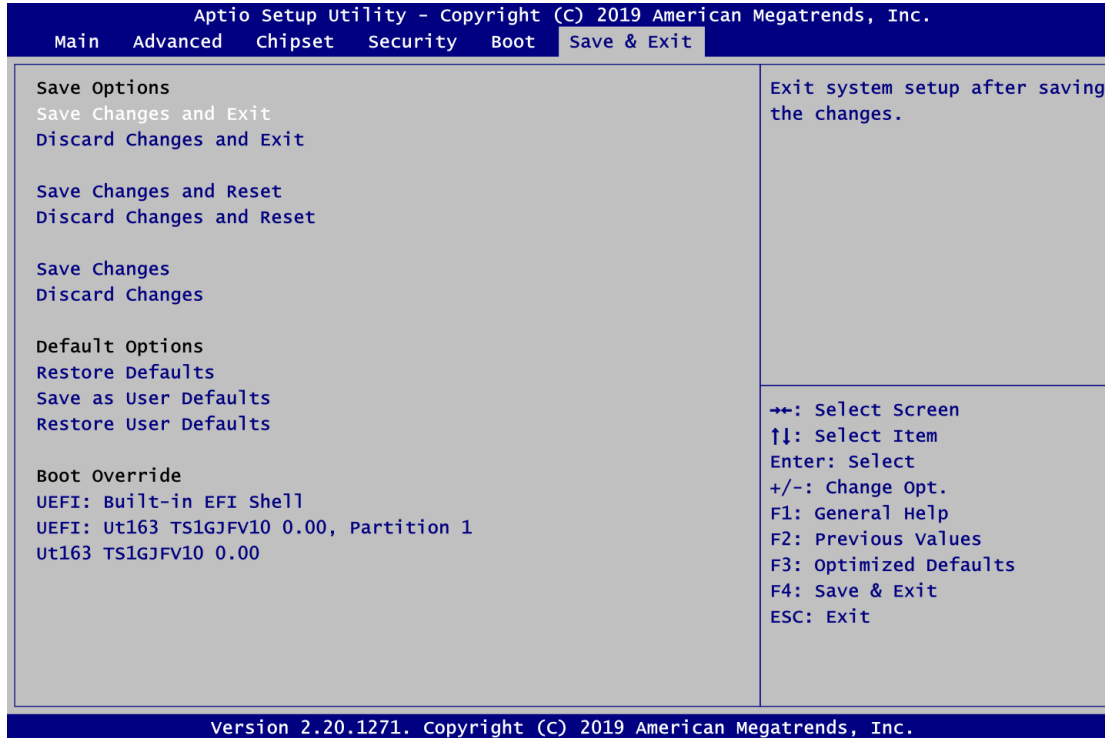

- Save Changes and Exit**
When you have completed the system configuration changes, select this option to leave Setup and return to Main Menu. Select Save Changes and Exit from the Save & Exit menu and press <Enter>. Select Yes to save changes and exit.
- Discard Changes and Exit**
Select this option to quit Setup without making any permanent changes to the system configuration and return to Main Menu. Select Discard Changes and Exit from the Save & Exit menu and press <Enter>. Select Yes to discard changes and exit.
- Save Changes and Reset**
When you have completed the system configuration changes, select this option to leave Setup and reboot the computer so the new system configuration parameters can take effect. Select Save Changes and Reset from the Save & Exit menu and press <Enter>. Select Yes to save changes and reset.
- Discard Changes and Reset**
Select this option to quit Setup without making any permanent changes to the system configuration and reboot the computer. Select Discard Changes and Reset from the Save & Exit menu and press <Enter>. Select Yes to discard changes and reset.
- Save Changes**
When you have completed the system configuration changes, select this option to save changes. Select Save Changes from the Save & Exit menu and press <Enter>. Select Yes to save changes.

- **Discard Changes**
Select this option to quit Setup without making any permanent changes to the system configuration. Select Discard Changes from the Save & Exit menu and press <Enter>. Select Yes to discard changes.
- **Restore Defaults**
It automatically sets all Setup options to a complete set of default settings when you select this option. Select Restore Defaults from the Save & Exit menu and press <Enter>.
- **Save as User Defaults**
Select this option to save system configuration changes done so far as User Defaults. Select Save as User Defaults from the Save & Exit menu and press <Enter>.
- **Restore User Defaults**
It automatically sets all Setup options to a complete set of User Defaults when you select this option. Select Restore User Defaults from the Save & Exit menu and press <Enter>.
- **Boot Override**
Select a drive to immediately boot that device regardless of the current boot order.

This page is intentionally left blank.

Appendix A

Watchdog Timer

A.1 About Watchdog Timer

Software stability is major issue in most application. Some embedded systems are not watched by human for 24 hours. It is usually too slow to wait for someone to reboot when computer hangs. The systems need to be able to reset automatically when things go wrong. The watchdog timer gives us solution.

The watchdog timer is a counter that triggers a system reset when it counts down to zero from a preset value. The software starts counter with an initial value and must reset it periodically. If the counter ever reaches zero which means the software has crashed, the system will reboot.

A.2 Sample Program

1. Enter **ADU**, and press <F4> to select the **superior ITE**
2. **PORT** setting **002E**, **002F**
3. Address **07h** setting **07 GPIO**
4. Address **72h** to set the countdown, for example Sec: **C0**, Min: **40**
5. Address **73h** set the countdown time, for example 10sec: **0A**

This page is intentionally left blank.

Appendix B

TPM Settings

1. Setup BitLocker Drive Encryption main storage. Press <Win + R> and type "Control Panel", then select BitLocker Drive Encryption.

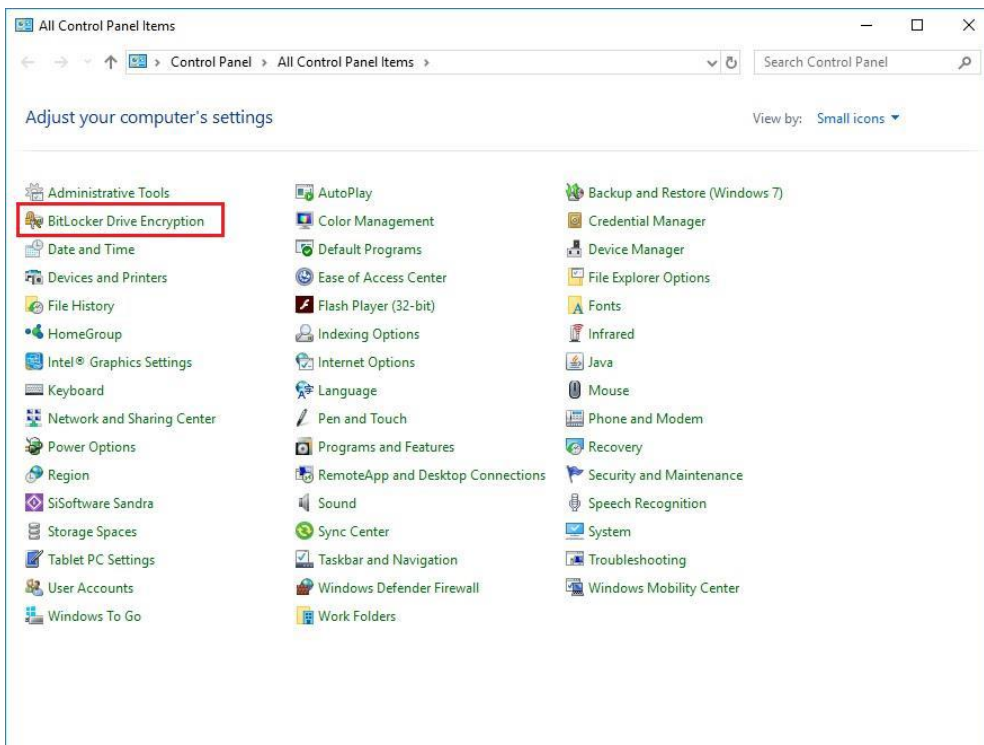
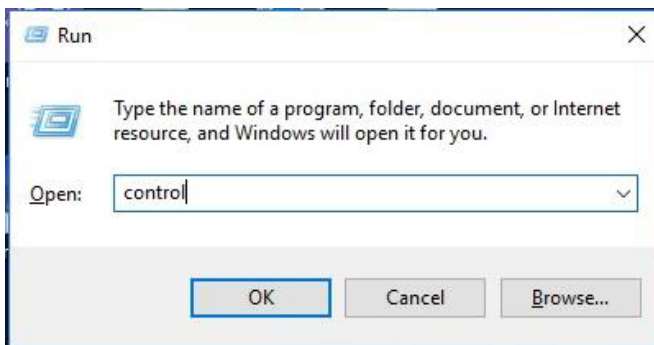

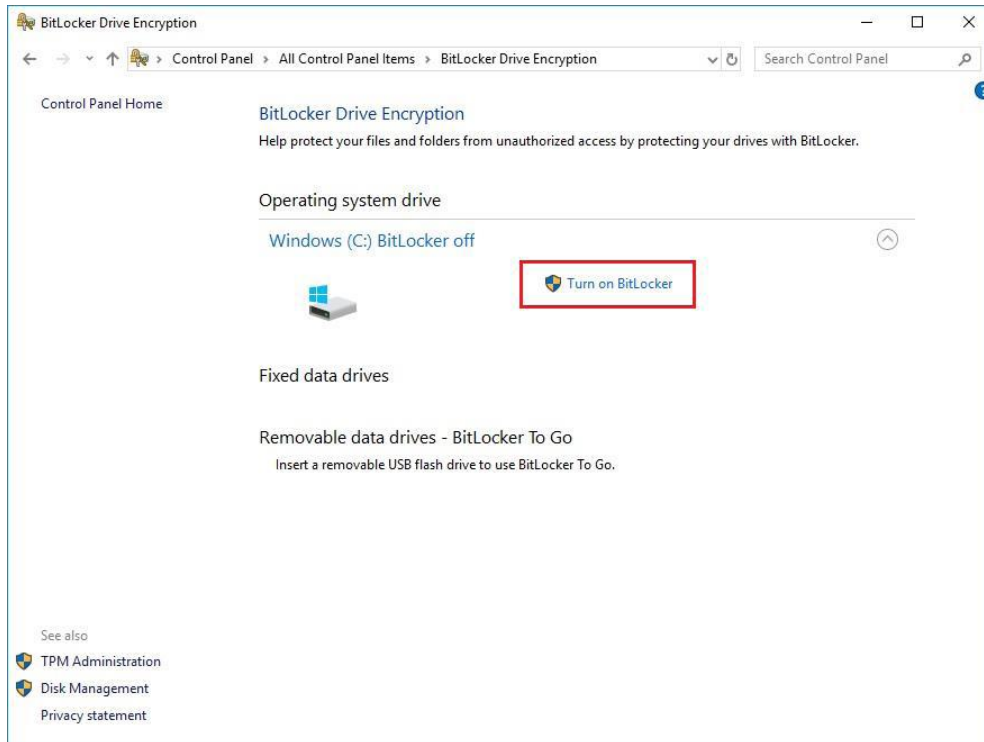

2. Insert an external storage device, for example USB Storage. Back up BitLocker recovery key in a new file and save it to the USB Storage.

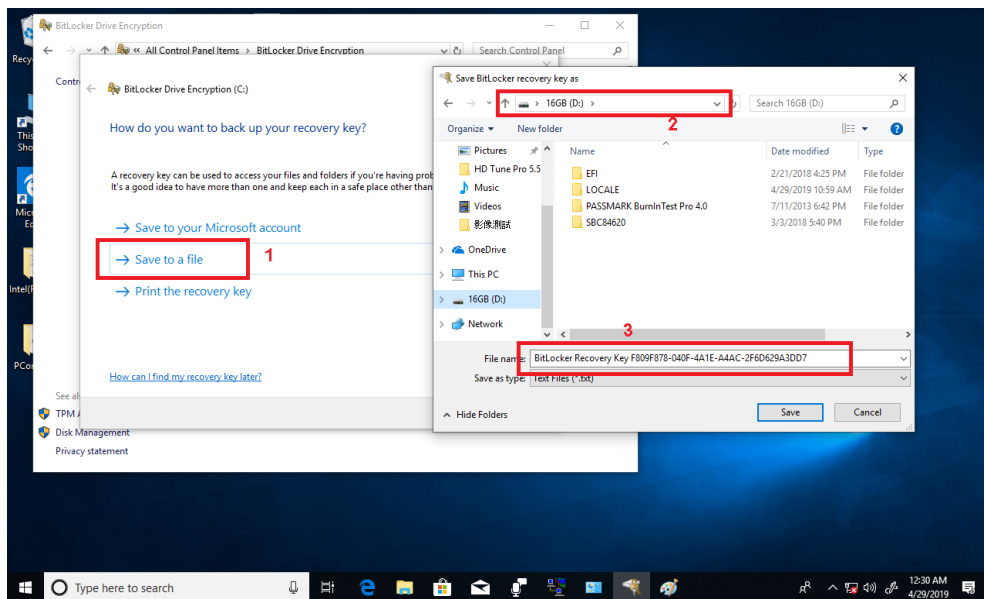

3. Please follow the steps below to encrypt your storage device:

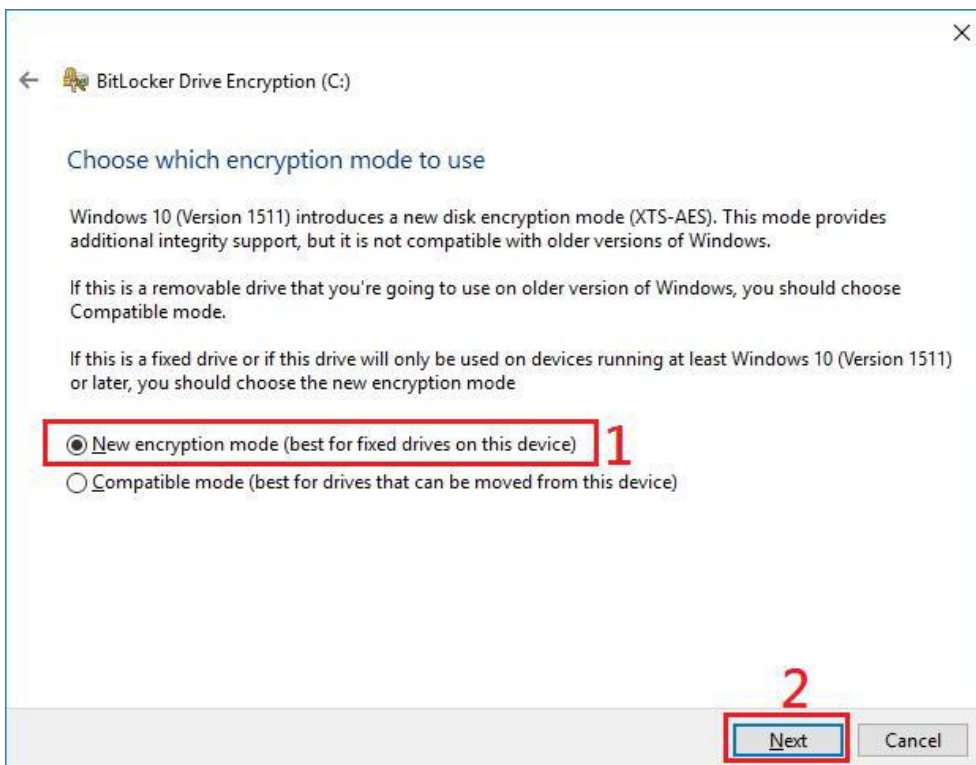
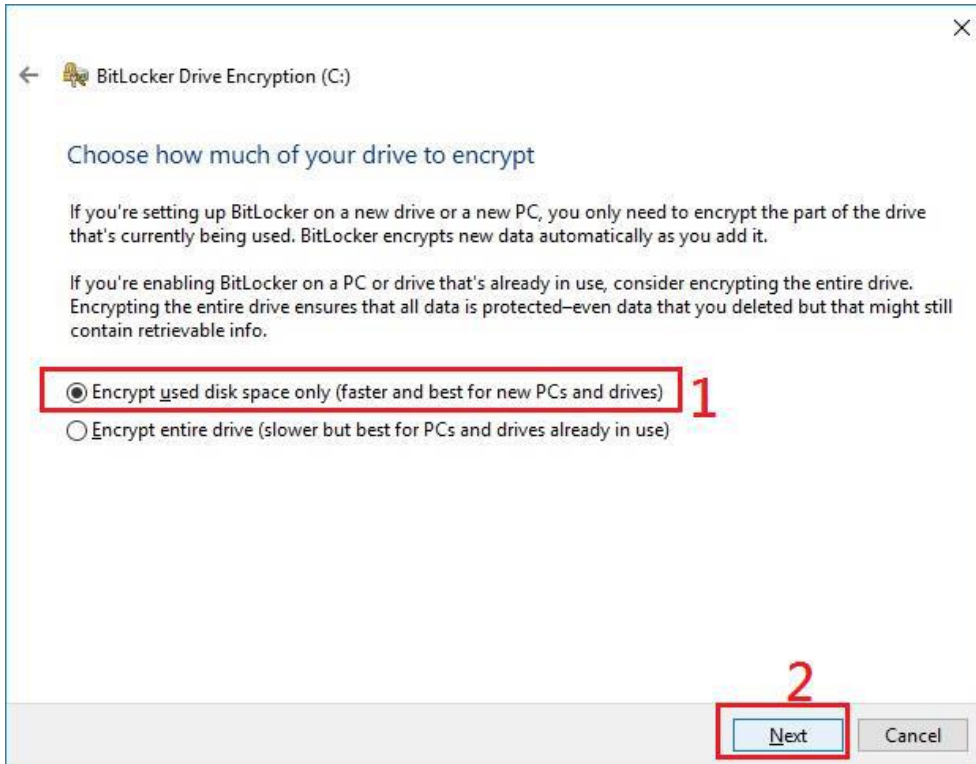

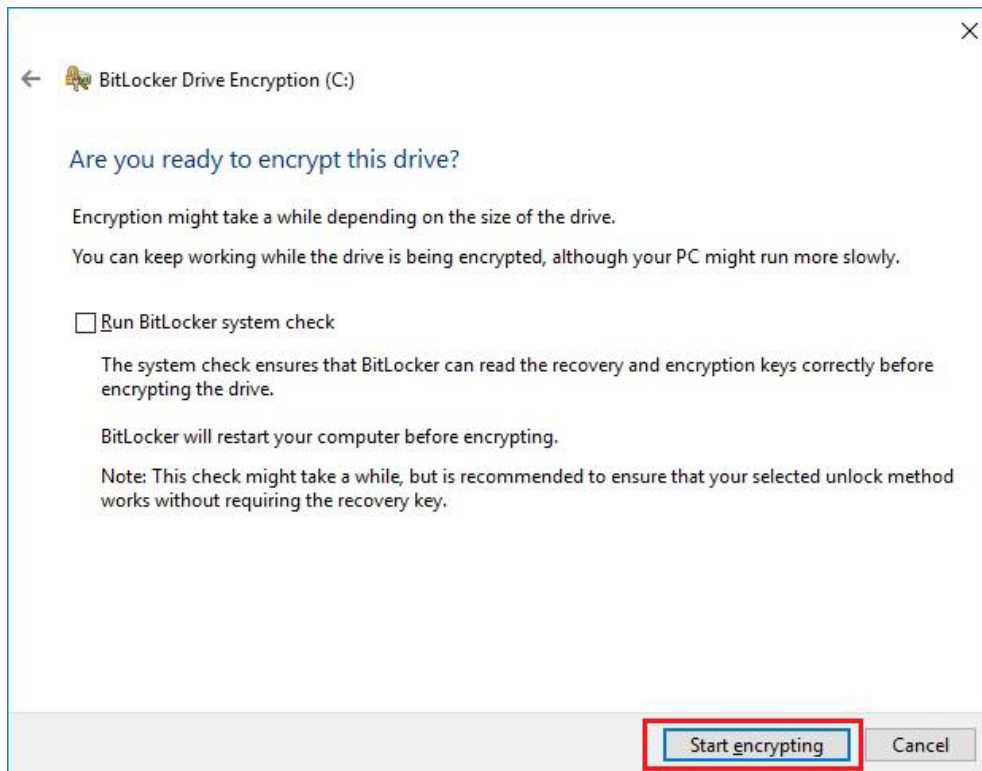

Now, the system prompts that the operating system drive encryption is in progress, and the encryption progress is checked.

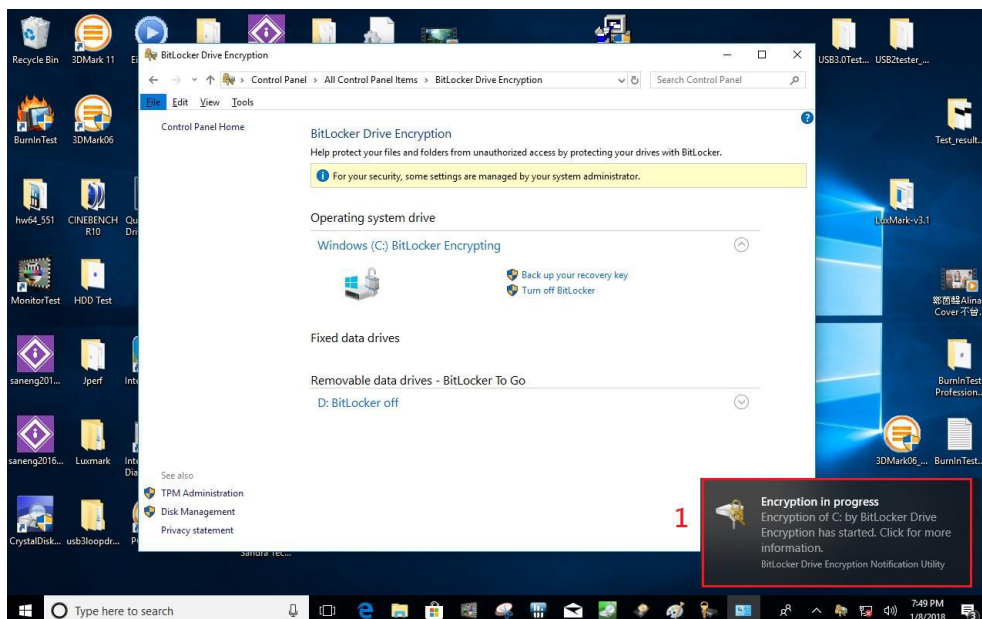

Select and click the icon in the lower right corner to complete the encryption.

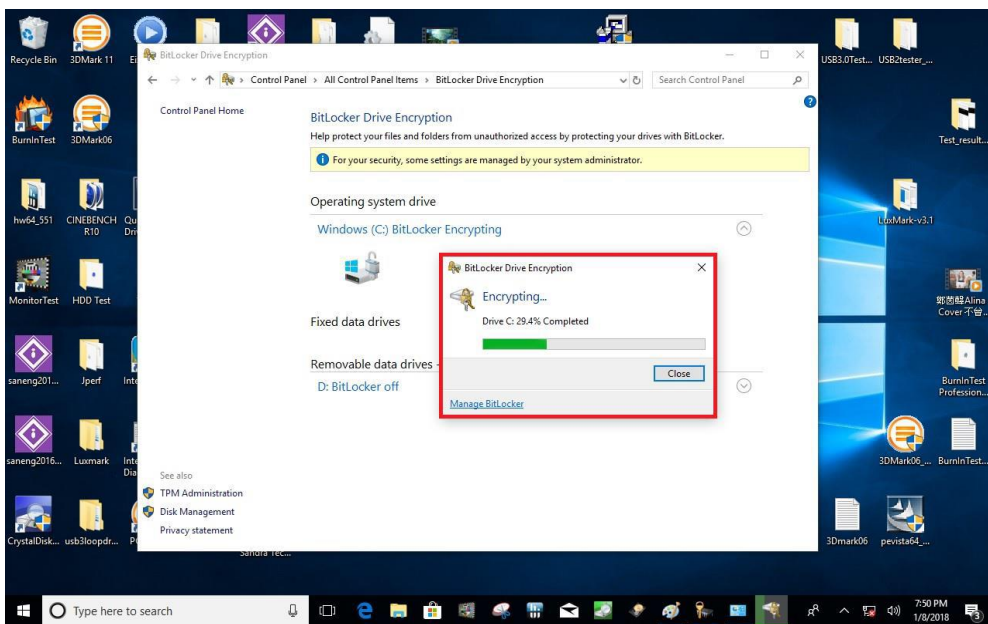
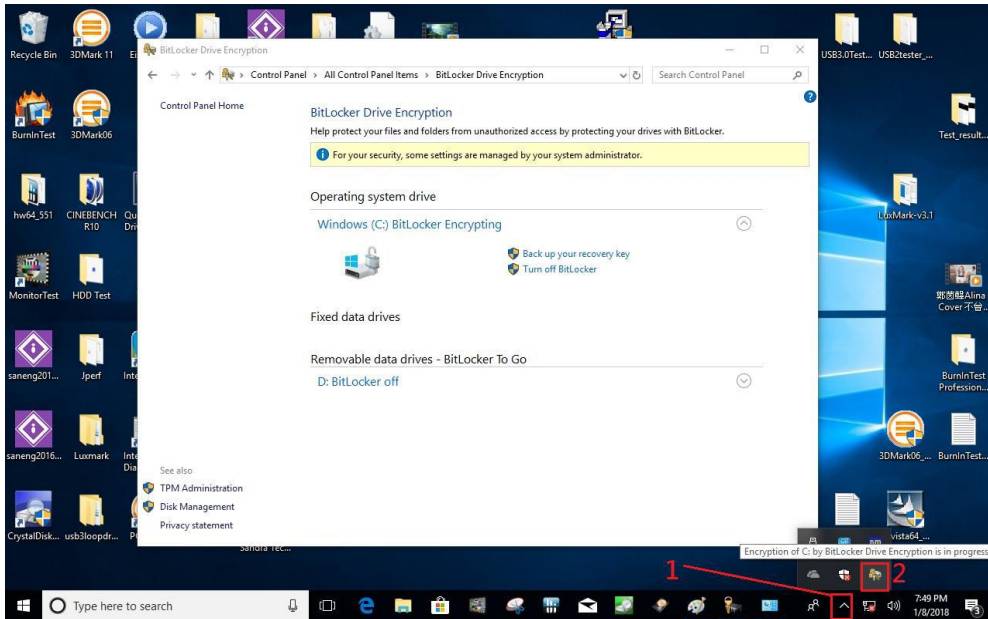

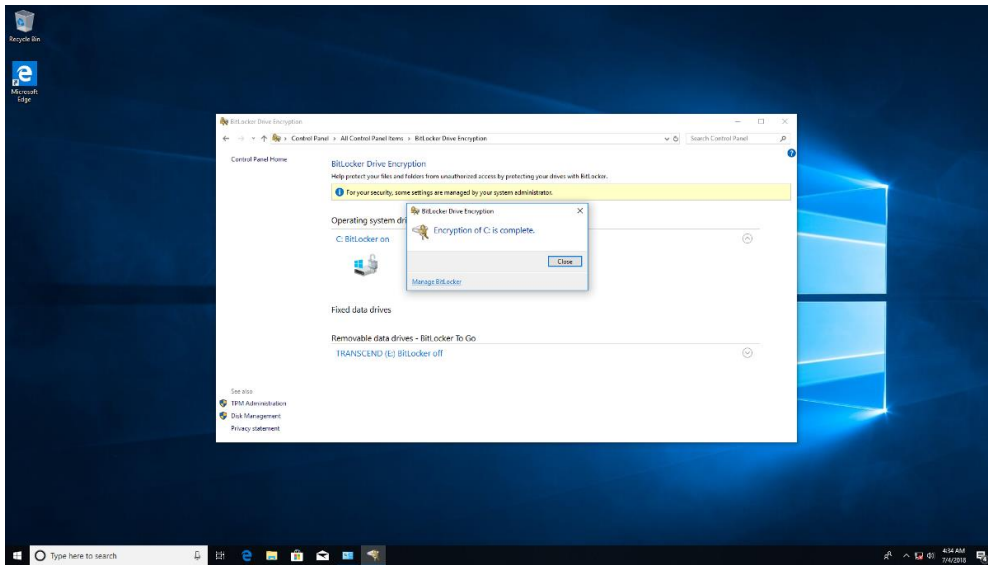

4. Confirm the completion of encryption.

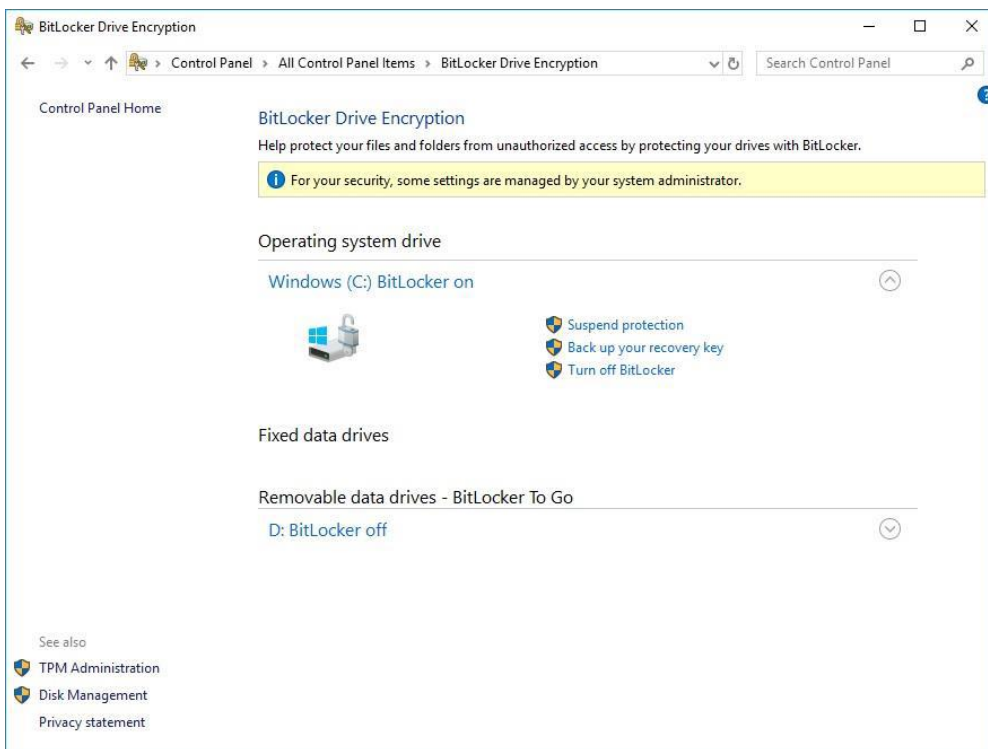

5. Disable TPM function in BIOS Setup Utility.

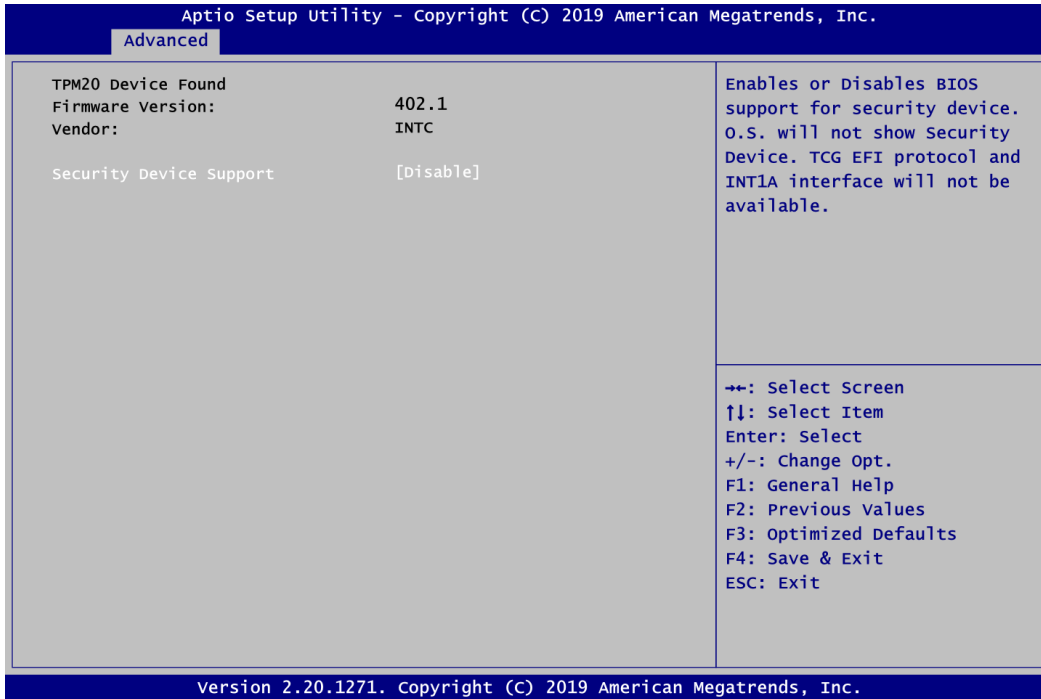

6. When the system is powered on and you see the following screen, it means the TPM module function is working fine. Note that BitLocker cannot be executed if your system does not have TPM function.



System with no TPM function support is as below:



Note

1. **TPM information is not found in Device Manager.**

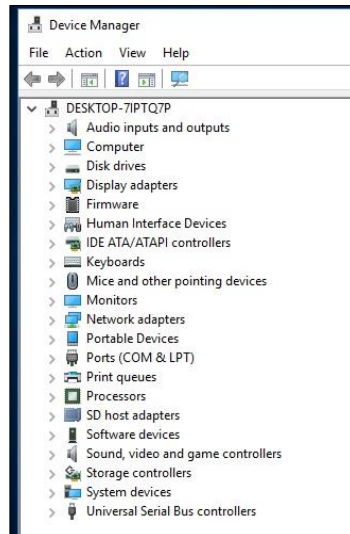

2. **When trying to turn on BitLocker, the following error message shows up.**

