

IPC974-519-FL

**Industrial and Fanless Computers
User's Manual**



USER'S MANUAL

www.axiomtek.com

Disclaimers

This manual has been carefully checked and believed to contain accurate information. Axiomtek Co., Ltd. assumes no responsibility for any infringements of patents or any third party's rights, and any liability arising from such use.

Axiomtek does not warrant or assume any legal liability or responsibility for the accuracy, completeness or usefulness of any information in this document. Axiomtek does not make any commitment to update the information in this manual.

Axiomtek reserves the right to change or revise this document and/or product at any time without notice.

No part of this document may be reproduced, stored in a retrieval system, or transmitted, in any form or by any means, electronic, mechanical, photocopying, recording, or otherwise, without the prior written permission of Axiomtek Co., Ltd.

©Copyright 2022 Axiomtek Co., Ltd.

All Rights Reserved

November 2022, Version A7

Printed in Taiwan

Safety Precautions

Before getting started, please read the following important safety precautions.

1. The IPC974-519-FL does not come equipped with an operating system. An operating system must be loaded first before installing any software into the computer.
2. Be sure to ground yourself to prevent static charge when installing the internal components. Use a grounding wrist strap and place all electronic components in any static-shielded devices. Most electronic components are sensitive to static electrical charge.
3. Disconnect the power cord from the IPC974-519-FL before making any installation. Be sure both the system and the external devices are turned OFF. Sudden surge of power could ruin sensitive components. Make sure the IPC974-519-FL is properly grounded.
4. Make sure the voltage of the power source is correct before connecting the equipment to the power outlet.
5. Turn OFF the system power before cleaning. Clean the system using a cloth only. Do not spray any liquid cleaner directly onto the screen.
6. Do not leave this equipment in an uncontrolled environment where the storage temperature is below -20°C or above 80°C . It may damage the equipment.
7. Do not open the system's back cover. If opening the cover for maintenance is a must, only a trained technician is allowed to do so. Integrated circuits on computer boards are sensitive to static electricity. To avoid damaging chips from electrostatic discharge, observe the following precautions:
 - Before handling a board or integrated circuit, touch an unpainted portion of the system unit chassis for a few seconds. This will help to discharge any static electricity on your body.
 - When handling boards and components, wear a grounding wrist strap, available from most electronic component stores.

Classification

1. Degree of protection against electric shock: not classified
2. Degree of protection against the ingress of water: IPX40
3. Equipment not suitable for use in the presence of a flammable anesthetic mixture with air or with oxygen or nitrous oxide.
4. Mode of operation: Continuous
5. Type of protection against electric shock: Class I equipment

General Cleaning Tips

You may need the following precautions before you begin to clean the computer. When you clean any single part or component for the computer, please read and understand the details below fully.

When you need to clean the device, please rub it with a piece of dry cloth.

1. Be cautious of the tiny removable components when you use a vacuum cleaner to absorb the dirt on the floor.
2. Turn the system off before you start to clean up the component or computer.
3. Never drop the components inside the computer or get circuit board damp or wet.
4. Be cautious of all kinds of cleaning solvents or chemicals when you use them for the sake of cleaning. Some individuals may be allergic to the ingredients.
5. Try not to put any food, drink or cigarette around the computer.

Cleaning Tools:

Although many companies have created products to help improve the process of cleaning computers and peripherals, users can also use household items to clean their computers and peripherals. Below is a listing of items available for cleaning computers or computer peripherals.

Keep in mind that some components in your computer may only be cleaned using a product designed for cleaning components of the same types. Please read the instructions that come with a cleaning product to avoid misuse.

- Cloth: A piece of cloth is the best tool to use when rubbing up a component. Although paper towels or tissues can be used on most hardware as well, it is recommended to use a piece of cloth.
- Water or rubbing alcohol: You may moisten a piece of cloth a bit with some water or rubbing alcohol and rub it on the computer. Unknown solvents may be harmful to the plastics parts.
- Vacuum cleaner: Vacuuming dust, dirt, hair, cigarette particles, and other particles out of a computer can be one of the best methods of cleaning a computer. Over time these items can restrict the airflow in a computer and cause circuitry to corrode.
- Cotton swabs: Cotton swabs moistened with rubbing alcohol or water are excellent tools for wiping hard to reach areas in your keyboard, mouse, and other locations.
- Foam swabs: If possible, use lint free swabs such as foam swabs.



Note: It is strongly recommended that you should shut down the system before you start to clean any single components.

Please follow the steps below:

1. Close all application programs;
2. Close operating software;
3. Turn off power switch;
4. Remove all device;
5. Pull out power cable.

Scrap Computer Recycling

Please inform the nearest Axiomtek distributor as soon as possible for suitable solutions in case computers require maintenance or repair; or for recycling in case computers are out of order or no longer in use.

Trademark Acknowledgments

Axiomtek is a trademark of Axiomtek Co., Ltd.

Intel® and Pentium® are registered trademarks of Intel Corporation.

Windows 10, Windows 10 IoT Enterprise, Windows 7, are trademarks of Microsoft Corporation.

Other brand names and trademarks are the properties and registered brands of their respective owners.

Table of Contents

Safety Precautions	iii
Classification	iv
General Cleaning Tips	iv
Scrap Computer Recycling.....	vi
SECTION 1 INTRODUCTION.....	1
1.1 General Description	1
1.2 System Specifications	2
1.2.1 Main CPU Board.....	2
1.2.2 I/O System	3
1.3 M/B Block Diagram & System Dimensions	7
1.4 Outlets	9
1.5 Packing List.....	11
1.6 Jumper Settings.....	12
1.6.1 Restore BIOS Optimal Defaults (JP3)	12
1.7 Connectors.....	13
1.7.1 MINI CARD SLOT (CN4).....	14
1.7.2 LAN+USB3.0 (CN8 \ CN9)	15
1.7.3 VGA Connector (CN10)	16
1.7.4 USB 2.0 Connector (CN11).....	17
1.7.5 Audio Connector (CN12)	17
1.7.6 DC-in Phoenix Power Connector (CN15).....	17
1.7.7 HDMI Connector (CN13).....	18
1.7.8 SATA Power connector (SCN1 \ SCN2)	18
1.7.9 SATA Connector (SATA1~SATA4).....	19
1.7.10 Power On/OFF Button(SW1).....	19
1.7.11 AT/ATX Switch (SW3).....	19
1.7.12 Reset Button(SW2)	20
1.7.13 Remote Power Switch Connector (PWRBT1)	20
1.7.14 Flexible IO - COM I/O Card Connector (AX93511)	20
1.7.15 Flexible IO – Isolated COM & DIO I/O Card (AX93512).....	21
1.7.16 Flexible IO – Isolated COM x4 I/O Card (AX93516).....	24
1.7.17 Flexible IO – USB3.0x2 & COMx2(RS232/422/485) & LAN1(AX93519)	25
1.7.18 Riser Card- PCIe x16 Gen3 & 3 PCIe x4 Gen 3(AX96410).....	28
1.7.19 Riser Card- PCIe x16 Gen3 & 1 PCIe x4 Gen 3 & 2 PCI(AX96411)	30
SECTION 2 HARDWARE INSTALLATION	33
2.1 Installing the Processor	33
2.2 Installing the Memory Module.....	35
2.3 Installing the Hard Disk Drive	37
2.4 Installing the PCI or PCIe Card.....	39
2.4.1 Installing PCI or PCIe add-in card	40
2.4.2 Installing graphics card	42
2.4.3 The length limitation of an add-in card	45
2.4.4 Installing the Fan Module	51

2.5	Installing the WIFI Module	53
2.6	Installing USB dongle kit.....	54
2.7	Installing foot pad.....	55
2.8	Wall mounting.....	56
SECTION 3 AMI BIOS UTILITY		57
3.1	Starting	57
3.2	Navigation Keys	58
3.3	Main Menu	59
3.4	Advanced Menu	60
3.5	Chipset Menu	75
3.6	Security Menu	82
3.7	Boot Menu	83
3.8	Save & Exit Menu	84
APPENDIX A WATCHDOG TIMER		87
A.1	About Watchdog Timer.....	87
A.2	How to Use Watchdog Timer.....	87
APPENDIX B HDD HOT-SWAPPABLE.....		93
	Using HDD hot-swappable function	93
	Removing Hot-Swappable storage.....	94
APPENDIX C CONFIGURING SATA FOR RAID.....		97

SECTION 1

INTRODUCTION



This chapter contains general information and detailed specifications of the IPC974-519-FL. Chapter 1 includes the following sections:

- General Description
- System Specifications
- Dimensions
- I/O Outlets
- Jumper Settings
- Connectors
- Package List

1.1 General Description

The IPC974-519-FL is a fanless system that supports the LGA1151 socket for Intel® Xeon and 6th/7th generation Core™ i7/i5/i3 processors. The IPC974-519-FL supports Windows® 7 and Windows® 10, with a rugged design that makes it suitable for the most enduring operation.

- The IPC974-519-FL supports two hard-drive bays, which allow customers to easily add storage and maintain the system.
- Embedded O.S. supported

The IPC974-519-FL not only supports Windows® 7 and Windows® 10, but also supports embedded OS, such as Windows® 7 embedded. For storage device, the IPC974-519-FL supports four HDD drive bays

1.2 System Specifications

1.2.1 Main CPU Board

- CPU

Socket LGA1151 for 6th /7th Generation Intel® Core™ i7/i5/i3 and Xeon processors, up to 80W. CPU support is listed as below.

Processor	Core	Thread	Base frequency	TDP
i5-6400T	4	4	2.20 GHz	35 W
i5-6500TE	4	4	2.30 GHz	35 W
E3-1268LV5	4	8	2.40 GHz	35 W
G4400TE	2	2	2.40 GHz	35 W
i7-6700TE	4	8	2.40 GHz	35 W
G3930TE	2	2	2.70 GHz	35 W
i3-6100TE	2	4	2.70 GHz	35 W
i5-7500T	4	4	2.70 GHz	35 W
i7-6700T	4	8	2.80 GHz	35 W
i7-7700T	4	8	2.90 GHz	35 W
i3-7101TE	2	4	3.40 GHz	35 W
i5-6400	4	4	2.70 GHz	65 W
i5-6500	4	4	3.20 GHz	65 W
i5-7500	4	4	3.40 GHz	65 W
G4400	2	2	3.30 GHz	54 W
i7-6700	4	8	3.40 GHz	65 W
i7-7700	4	8	3.60 GHz	65 W
i3-6100	2	4	3.70 GHz	51 W
i3-7101E	2	4	3.90 GHz	54 W
E3-1275V6	4	8	3.80 GHz	73 W
E3-1225V5	4	4	3.30 GHz	80 W
E3-1275V5	4	8	3.60 GHz	80 W

- System Chipset

- Intel® C236 chipset

- BIOS

- AMI BIOS, with Smart View and Customer CMOS Backup.

- **System Memory**
 - Two DDR4-2133/2400 un-buffered ECC SO-DIMM max. up to 32GB
- **Features**
 - Fanless operation
 - Compact & front IO design
 - Supports four expansion slots
 - DC to DC power supply; supports 24VDC (uMin=19V/uMax=30V)
 - TPM2.0
 - Supports system power on delay function
 - Supports Intel® RAID 0,1,5

1.2.2 I/O System

- **Standard I/O Interface -- Font**
 - One ATX power on/off switch
 - One 4-pin terminal block
 - One ATX/AT Mode switch
 - One Reset switch
 - One 2-pin connector output for remote power on/off switch
 - DC to DC power supply, supports 24VDC (uMin=19V/uMax=30V) with phoenix power plug
 - Four USB 3.0 ports
 - Two USB 2.0 ports
 - HDD access/power LED
 - Two G.E. LAN ports (i219LM and i211AT)
 - One Ground Terminal
 - Flexible IO
 - AX93511 4 x RS-232/422/485 module (default RS-232)
 - AX93512 2 x RS-232/422/485 w/ isolated 1.5KVDC protection and 8-in/8-out isolated 1.5KVDC DIO
 - AX93516 4 x RS232/422/485 w/isolated 2KVDC module
 - AX93519 2 x RS232/422/485 + 2 USB3.0 + 1 G.E. LAN(i211AT)
-  **Note: The RS-485 auto flow control only supports below formats to communicate data:**
- 8 data bits + 1 stop bit
 - 8 data bits + 1 parity bit + 1 stop bit

8 data bits + 1 parity bit + 2 stop bits

8 data bits + 2 stop bits

7 data bits + 1 parity bit (even or odd) + 2 stop bits

- One VGA supports resolution up to 1920 x 1200 @60Hz
- One HDMI 1.4b supports resolution up to 4096 x 2160 @24Hz
- 1 x Audio (Line-out)

Expansion Slot

- 1 x on board full-size PCI Express Mini Card slot with USB/PCIe interface w/SIM slot
- AX96410: 1 PCIe16 + 3 PCIe4
- AX96411: 1 PCIe16 + 1 PCIe4 + 2 PCI



Note: The maximum power rating for expansion slots at 60 °C cannot exceed the following value:

The maximum power loading of +3.3V+5V+12V<150W

The maximum power loading of +3.3V+5V+12V<480W (w/AX98268 300W power board)



Note: 12V maximum loading 10A(120W), the remaining 30W is shared by 3.3V & 5V.



Note: The system power rating may thus be changed base on differing device combinations.

1.2.3 System Specification

● Drive Capacity

- 1 x HDD drive bay (default, supports 2 x 2.5" HDD/SSD)
- 1 x HDD drive bay (optional, supports 2 x 2.5" HDD/SSD)
(height 7mm or 9.5mm)



Note: Since Gen. 2 SSD with JMicron controller has compatibility issue with Intel PCH, it is strongly recommended to use Gen. 3 SSD on IPC974-519.

● Power Input

- 24VDC (uMin=19V/uMax=30V) with phoenix power plug
- Inrush current 40A or less

- Operation Temperature

Processor	Core	Thread	Base frequency	TDP	Operating temperature (Ambient with air flow & W.T. HDD or W.T. SSD)
i5-6400T	4	4	2.20 GHz	35 W	-10°C-70°C
i5-6500TE	4	4	2.30 GHz	35 W	-10°C-70°C
E3-1268LV5	4	8	2.40 GHz	35 W	-10°C-70°C
G4400TE	2	2	2.40 GHz	35 W	-10°C-70°C
i7-6700TE	4	8	2.40 GHz	35 W	-10°C-70°C
G3930TE	2	2	2.70 GHz	35 W	-10°C-60°C
i3-6100TE	2	4	2.70 GHz	35 W	-10°C-60°C
i5-7500T	4	4	2.70 GHz	35 W	-10°C-60°C
i7-6700T	4	8	2.80 GHz	35 W	-10°C-60°C
i7-7700T	4	8	2.90 GHz	35 W	-10°C-60°C
i3-7101TE	2	4	3.40 GHz	35 W	-10°C-60°C
i5-6400	4	4	2.70 GHz	65 W	-10°C-60°C
i5-6500	4	4	3.20 GHz	65 W	-10°C-60°C
i5-7500	4	4	3.40 GHz	65 W	-10°C-60°C
G4400	2	2	3.30 GHz	54 W	-10°C-50°C
i7-6700	4	8	3.40 GHz	65 W	-10°C-50°C
i7-7700	4	8	3.60 GHz	65 W	-10°C-50°C
i3-6100	2	4	3.70 GHz	51 W	-10°C-50°C
i3-7101E	2	4	3.90 GHz	54 W	-10°C-50°C
E3-1275V6	4	8	3.80 GHz	73 W	-10°C-50°C
E3-1225V5	4	4	3.30 GHz	80 W	-10°C-50°C
E3-1275V5	4	8	3.60 GHz	80 W	-10°C-50°C

- **Storage Temperature**

- -20°C ~ 80°C

- **Humidity**

- 10% ~ 90% (Non-condensing)

- **Dimensions**

- 188.14 mm (7.40") (W) x 192 mm (7.54) (H) x 317 mm (12.46") (D)
- 188.14 mm (7.40") (W) x 192 mm (7.54) (H) x 349.5 mm (13.73") (D)
(w/ external fan module)



Note: All specifications and images are subject to change without notice.



Note: The performance of the system could be adversely affected at an over spec operating temperature or with an unrecommended processor.



Note: If the operating temperature is above 35°C, it is recommended to use a wide temperature SSD on the device.



Note: If the operating temperature is above 35°C, it is recommended to use a wide temperature Wi-Fi module on the device.

1.3 M/B Block Diagram & System Dimensions

The following diagram shows you M/B block diagram of IPC974-519-FL.

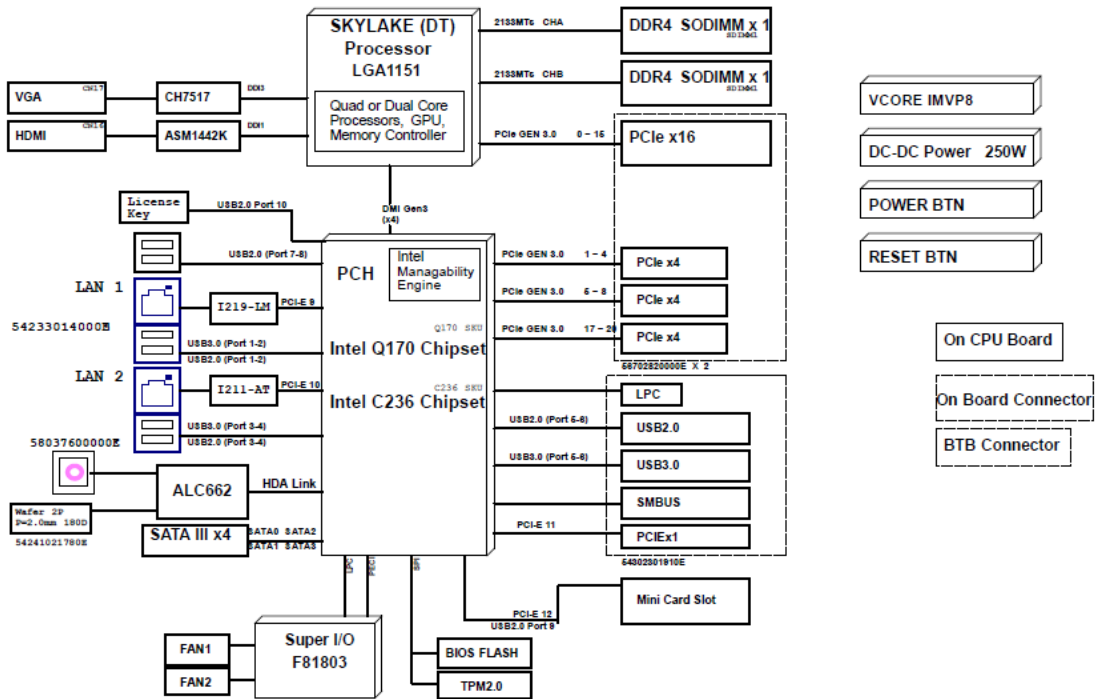

The following diagrams show you the system dimensions.

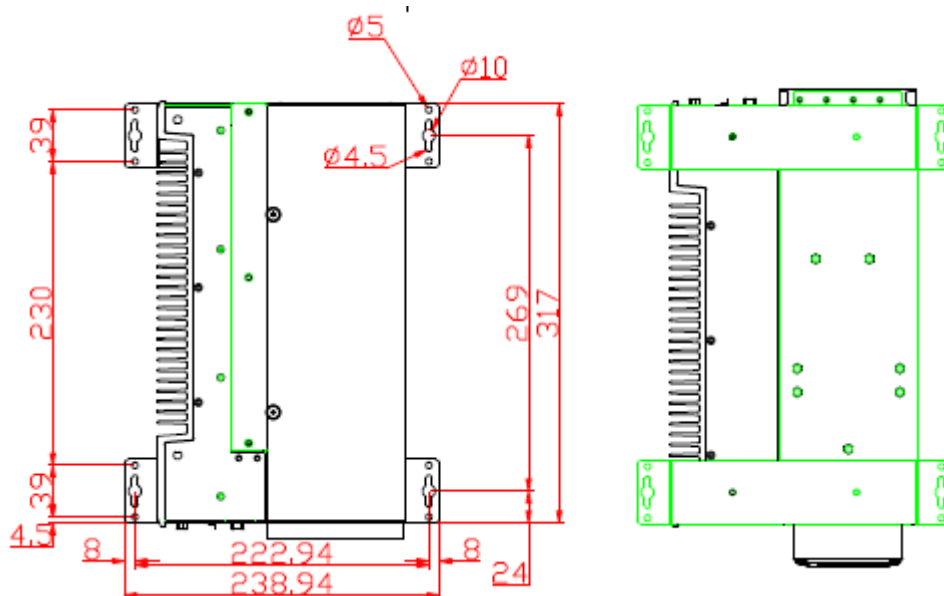

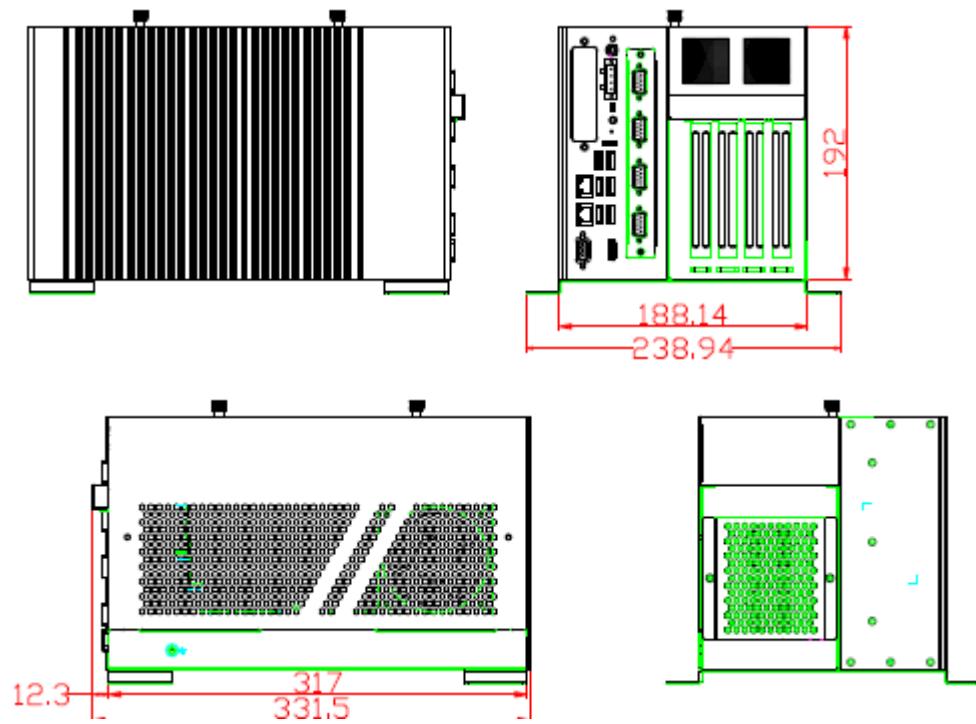

The following diagrams show you the system dimensions with external fan module.

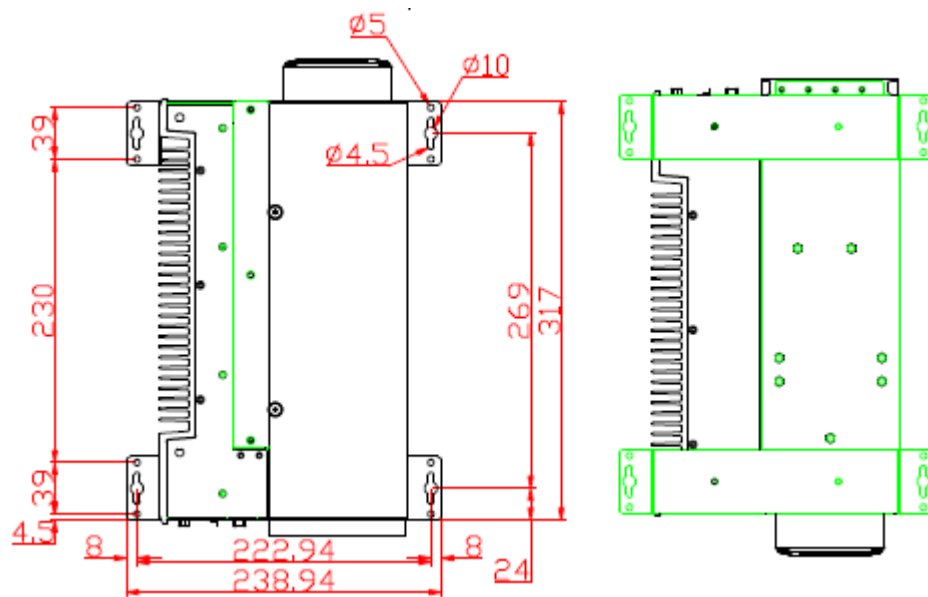

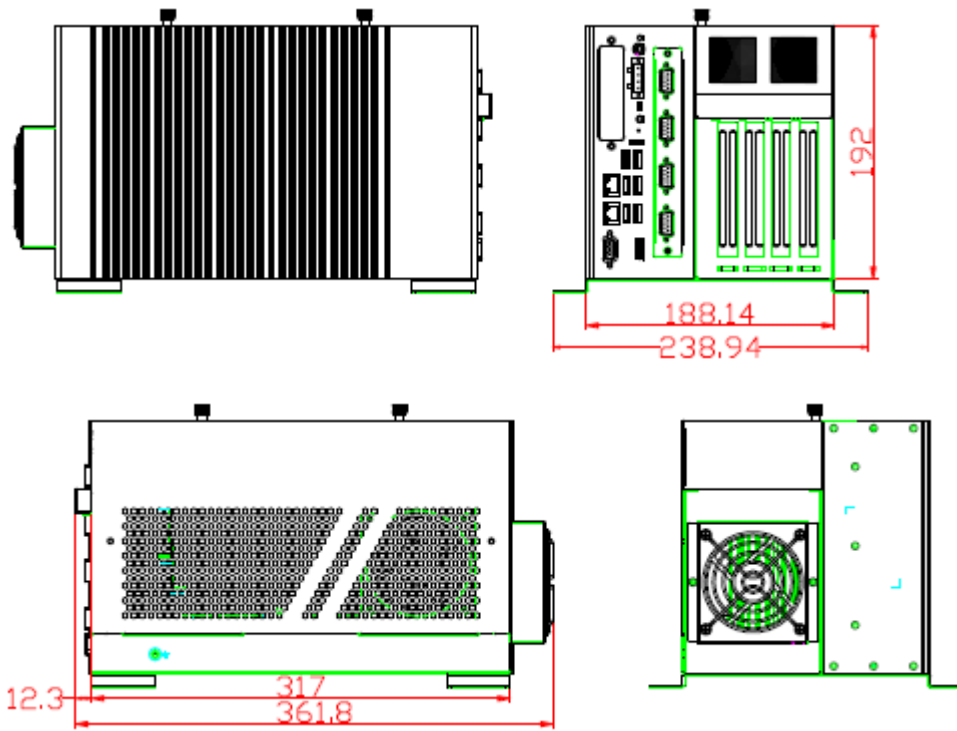

1.4 Outlets

The following figures show you outlets on the front and top panels of the IPC974-519-FL.



No.	Description
1	2 x Antenna opening
2	1 x HDD drive bay(default, support 2 x 2.5" HDD/SSD)
3	1 x HDD drive bay(optional, support 2 x 2.5" HDD/SSD)
4	HDD access/power LED
5	Power on/off switch
6	Extension Window (1)Blank cover (default) (2)1 x Wifi kit and/or (3) 1 x USB dongle kit (4)AX92902+AX93287: 1 x 10/100/1000 Mbps Ethernet module (Intel®i210-AT) (5) AX92903: CANBus module (6) AX92906: 1 x RS-232 module
7	4-pin terminal block
8	AT/ATX mode switch
9	Line out
10	Reset switch
11	2-pin connector output for remote power on/off switch
12	2 x USB 2.0
13	1 x 10/100/1000Mbps ethernet(i211-AT) 2 x USB3.0
14	1 x 10/100/1000Mbps ethernet(i219LM) 2 x USB3.0
15	VGA
16	HDMI
17	Extension System I/O Module (1) AX93511: 4 x RS-232/422/485 module (default RS-232) (2) AX93512: 2 x RS-232/422/485 with isolated 1.5kVDC & 8-in/8-out with isolated 1.5kVDC DIO module (3) AX93516: 4 x RS-232/422/485 with isolated 2kVDC module (4) AX93519: 1 x 10/100/1000 Mbps (Intel® i211-AT) Ethernet, 2 x RS-232/422/485, and 2 x USB 3.0 module (5)Blank I/O cover
18	Expansion Interface
10	(1) AX96410: 1 PCIe x16 + 3 PCIe x4 (2) AX96411: 1 PCIe x16 + 1 PCIe x4 + 2 PCI
19	1 x Terminal ground

1.5 Packing List

The package bundled with your IPC974-519-FL should contain the following items:

- IPC974-519-FL unit x 1
- Screw pack x 1
- Foot pad x 4
- CPU grease x 1
- Terminal block x 1
- Remote switch cable x 1
- Extension holder bracket kit x 1
- HDD spacer x 1

If you cannot find this package or any items are missing, please contact Axiomtek distributors immediately.

1.6 Jumper Settings

Properly configure jumper settings on the SBC87511/SBC87512 to meet your application purpose. Below you can find a summary table of all jumpers and onboard default settings.



Note:How to setup Jumpers

Illustrations below show that a cap on a jumper is to “close” the jumper, whereas that off a jumper is to “open” the jumper.



Jumper	Descriptions	Setting
JP3	Clear RTC : Normal	Short 1-2

1.6.1 Restore BIOS Optimal Defaults (JP3)

Put jumper clip to pin 2-3 for a few seconds then move it back to pin 1-2. Doing this procedure can restore BIOS optimal defaults.

Function	Setting
Normal operation (Default)	1-2 close
Restore BIOS optimal defaults	2-3 close

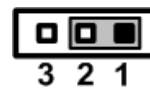

1.7 Connectors

Connectors connect the board with other parts of the system. Loose or improper connection might cause problems. Make sure all connectors are properly and firmly connected.

Here is a table summarizing all connectors on the board.

Connector	Label
MINI Card slot	CN4
LAN1+USB3.0	CN8
LAN2+USB3.0	CN9
VGA connector	CN10
USB 2.0 connector	CN11
Audio connector	CN12
DC-in Phoenix power connector	CN15
HDMI connector	CN13
SATA Power connector	SCN1、SCN2
SATA III connector	SATA1~4
DDR4 SO-DIMM (260 Pin)	SDIMM1、SDIMM2
Power button	SW1
AT/ATX Power select	SW3
Reset button	SW2
Remote SW	PWRBT1
Flexible IO – COM x4(RS232/422/485)	AX93511
Flexible IO – Isolated COM x4(RS232/422/485)	AX93516
Flexible IO – Isolated COM x2(RS232/422/485) & 8in/8out DIO	AX93512
Flexible IO – COM x2(RS232/422/485), USB3.0 x2 & LAN1	AX93519
Riser Card – PCIe x16 Gen3 & 3 PCIe x4 Gen 3	AX96410
Riser Card – PCIe x16 Gen3 & 1 PCIe x4 Gen 3 & 2 PCI	AX96411

1.7.1 MINI CARD SLOT (CN4)

A PCI-Express Mini Card connector is located on the top side . It follows the mini PCIe 1.2 standard.

Pins	Signals	Pins	Signals
1	WAKE#	2	+3.3VSB
3	No use	4	GND
5	No use	6	+1.5V
7	CLKREQ#	8	No use
9	GND	10	No use
11	REFCLK-	12	No use
13	REFCLK+	14	No use
15	GND	16	No use
17	No use	18	GND
19	No use	20	W_DISABLE#
21	GND	22	PERST#
23	PE_RXN3/	24	+3.3VSB
25	PE_RXP3/	26	GND
27	GND	28	+1.5V
29	GND	30	SMB_CLK
31	PE_TXN3/	32	SMB_DATA
33	PE_TXP3/	34	GND
35	GND	36	USB_D8-
37	GND	38	USB_D8+
39	+3.3VSB	40	GND
41	+3.3VSB	42	No use
43	GND	44	No use
45	No use	46	No use
47	No use	48	+1.5V
49	No use	50	GND
51	No use	52	+3.3VSB

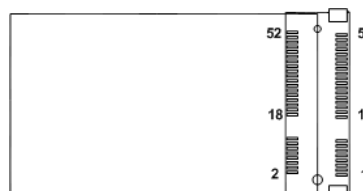

1.7.2 LAN+USB3.0 (CN8、CN9)

The system has two RJ-45 connectors: LAN1 and LAN2. Ethernet connection can be established by plugging one end of the Ethernet cable into this RJ-45 connector and the other end (phone jack) to a 1000/100/10-Base-T hub.

Pins	1000 Base-T	100/10 Base-T	Descriptions
L1	BI_DA+	TX+	Bidirectional or Transmit Data+
L2	BI_DA-	TX-	Bidirectional or Transmit Data-
L3	BI_DB+	RX+	Bidirectional or Receive Data+
L4	BI_DC+	N.C.	Bidirectional or Not Connected
L5	BI_DC-	N.C.	Bidirectional or Not Connected
L6	BI_DB-	RX-	Bidirectional or Receive Data-
L7	BI_DD+	N.C.	Bidirectional or Not Connected
L8	BI_DD-	N.C.	Bidirectional or Not Connected
A	Active Link LED (Yellow) Off: No link Blinking: Data activity detected		
B	Speed LED 1000: Orange 100: Green 10: OFF		

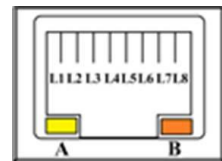

The Universal Serial Bus connectors are compliant with USB 3.0 (5Gb/s), and ideally for installing USB peripherals such as scanner, camera and USB devices, etc.

Pins	Signal USB Port 0	Pins	Signal USB Port 1
1	USB_VCC (+5V level standby power)	10	USB_VCC (+5V level standby power)
2	USB_Data2-	11	USB_Data3-
3	USB_Data2+	12	USB_Data3+
4	GND	13	GND
5	SSRX2-	14	SSRX3-
6	SSRX2+	15	SSRX3+
7	GND	16	GND
8	SSTX2-	17	SSTX3-
9	SSTX2+	18	SSTX3+

1.7.3 VGA Connector (CN10)

The Connector is a 15-pin D-Sub connector which is commonly used for connecting a CRT monitor.

Pins	Signals	Pins	Signals
1	Red	2	Green
3	Blue	4	N.C.
5	GND	6	DETECT
7	GND	8	GND
9	+5V	10	GND
11	N.C.	12	DDC DATA
13	Horizontal Sync	14	Vertical Sync
15	DDC CLK		

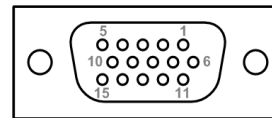

1.7.4 USB 2.0 Connector (CN11)

The Universal Serial Bus connectors are compliant with USB 2.0 (480Mbps), providing ideal interfaces ideal for installing USB peripherals such as a keyboard, mouse, scanner, etc.

Pin	Signal USB Port 0	Pin	Signal USB Port 1
1	USB VCC (+5V level)	5	USB VCC (+5V level)
2	USB D-	6	USB D-
3	USB D+	7	USB D+
4	Ground (GND)	8	Ground (GND)

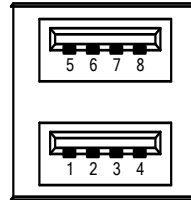

1.7.5 Audio Connector (CN12)

This audio jacks are ideal for Audio Line-out.

Pins	Signals
1	Line Out



1.7.6 DC-in Phoenix Power Connector (CN15)

The system supports the 24VDC (uMin=19V/uMax=30V) Phoenix DC-in connector for system power input.

Pins	Signals
1	DC+
2	DC+
3	DC-
4	DC-

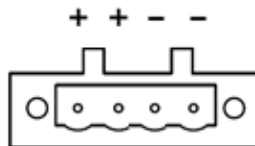

1.7.7 HDMI Connector (CN13)

The HDMI (High-Definition Multimedia Interface) is a compact digital interface which is capable of transmitting high-definition video and high-resolution audio over a single cable.

Pins	Signals	Pins	Signals
1	HDMI OUT_DATA2+	11	GND
2	GND	12	HDMI OUT Clock-
3	HDMI OUT_DATA2-	13	N.C.
4	HDMI OUT_DATA1+	14	N.C.
5	GND	15	HDMI OUT_SCL
6	HDMI OUT_DATA1-	16	HDMI OUT_SDA
7	HDMI OUT_DATA0+	17	GND
8	GND	18	+5V
9	HDMI OUT_DATA0-	19	HDMI_HTPLG
10	HDMI OUT Clock+		

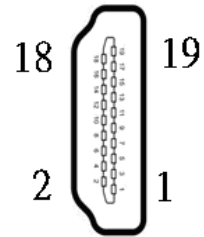

1.7.8 SATA Power connector (SCN1 、SCN2)

Use SCN1 、SCN2 for interfacing to SATA 2.5" HDD power supply.

Pins	Signals
1	+5V level
2	GND
3	GND
4	+5V level

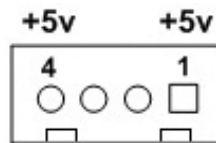

1.7.9 SATA Connector (SATA1~SATA4)

These Serial Advanced Technology Attachment (Serial ATA or SATA) connectors are used as high-speed SATA interfaces. They are computer bus interfaces for connecting to devices such as hard disk drives. This board has two SATA 3.0 ports with 6Gb/s performance.

Pins	Signals
1	GND
2	SATA_TX+
3	SATA_TX-
4	GND
5	SATA_RX-
6	SATA_RX+
7	GND

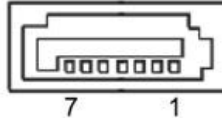

1.7.10 Power On/OFF Button(SW1)

The power button is on the I/O side. It allows users to control system power on/off.

Function	Description
On	Turn on/off system
Off	Keep system status



1.7.11 AT/ATX Switch (SW3)

If you set AT/ATX switch to AT mode, the system will be automatically powered on without pressing the soft power button during power input; we can use this switch to achieve auto power on demand.



1.7.12 Reset Button(SW2)

The Reset button allows users to reset system.

Function	Description
On	Reset system
Off	Keep system status



1.7.13 Remote Power Switch Connector (PWRBT1)

The system has one 2-pin connector output for remote power on/off switch.

Function	Description
Short(1-2)	Turn on/off system
Open	Keep system status

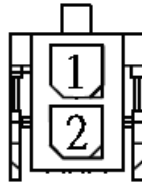

1.7.14 Flexible IO - COM I/O Card Connector (AX93511)

The system has four serial ports. COM1~COM4 are RS-232/422/485 ports.

*RS-232/422/485 can be configured via BIOS settings

※COM1,COM2,COM3,COM4

Pins	RS-232	RS-422	RS-485
1	DCD, Data Carrier Detect	TX-	Data-
2	RXD, Receive Data	TX+	Data+
3	TXD, Transmit Data	RX+	No use
4	DTR, Data Terminal Ready	RX-	No use
5	GND, Ground	No use	No use
6	DSR, Data Set Ready	No use	No use
7	RTS, Request To Send	No use	No use
8	CTS, Clear To Send	No use	No use
9	RI, Ring Indicator	No use	No use

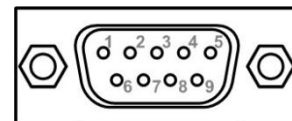

1.7.15 Flexible IO – Isolated COM & DIO I/O Card (AX93512)

The system has two serial ports. COM1~COM2 are RS-232/422/485 with isolated 1.5KVDC protection and DIO1~DIO2 8-in/8-out isolated 1.5KVDC DIO ports.

*RS-232/422/485 can be configured via BIOS settings

※COM1,COM2,DIO1,DIO2

CN1 (COM1)& CN2(COM2)			
Pins	RS-232	RS-422	RS-485
1	DCD, Data Carrier Detect	TX-	Data-
2	RXD, Receive Data	TX+	Data+
3	TXD, Transmit Data	RX+	No use
4	DTR, Data Terminal Ready	RX-	No use
5	GND, Ground	No use	No use
6	DSR, Data Set Ready	No use	No use
7	RTS, Request To Send	No use	No use
8	CTS, Clear To Send	No use	No use
9	RI, Ring Indicator	No use	No use
10	GND_EARTH	No use	No use

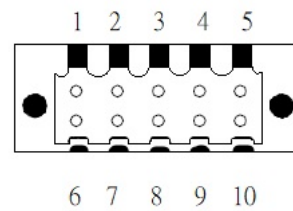

CN3(DIO1)		CN4(DIO2)	
Pin	Function	Pin	Function
1	Common1 PWR+	1	Common2 PWR+
2	DO10	2	DO20
3	DO11	3	DO21
4	DO12	4	DO22
5	DO13	5	DO23
6	Common1 PWR-	6	Common2 PWR-
7	External1 Power	7	External2 Power
8	DI10	8	DI20
9	DI11	9	DI21
10	DI12	10	DI22
11	DI13	11	DI23
12	Isolation1 GND	12	Isolation2 GND

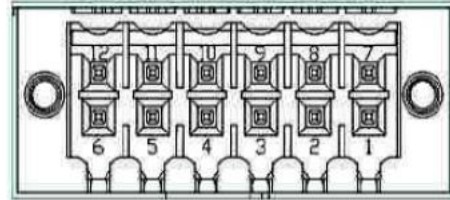

Digital I/O Specification (per port)

- **Isolated Digital Input**

The figure shows how to connect between external input source and the system.

Each of the isolated digital input channels accepts 0~30 VDC with sink type and source type.

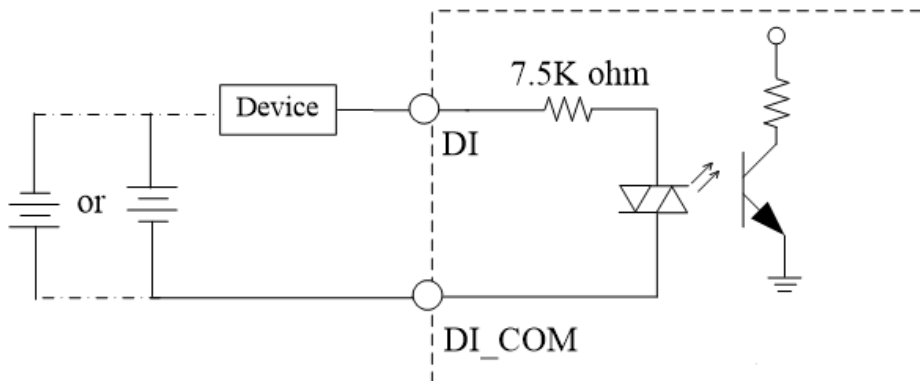

- **Isolated Digital Output**

The figure shows how to connect between an output channel and the system.

If an external voltage 5~30 VDC is applied to an isolated output channel, the current will flow from the external voltage source to the system.

Please note that the current through each DO channel should not exceed 200 mA.

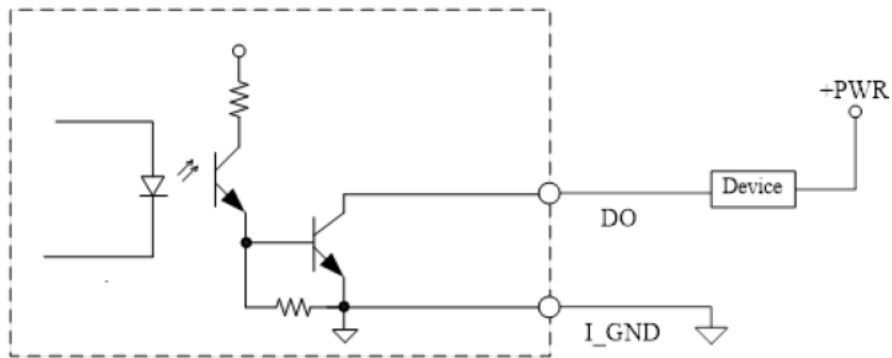

1.7.16 Flexible IO – Isolated COM x4 I/O Card (AX93516)

The system has four serial ports. COM1~COM4 are RS-232/422/485 with isolated 2KV ports. *RS-232/422/485 can be configured via BIOS settings

※COM1,COM2,COM3,COM4

Pins	RS-232	RS-422	RS-485
1	DCD, Data Carrier Detect	TX-	Data-
2	RXD, Receive Data	TX+	Data+
3	TXD, Transmit Data	RX+	No use
4	DTR, Data Terminal Ready	RX-	No use
5	GND, Ground	No use	No use
6	DSR, Data Set Ready	No use	No use
7	RTS, Request To Send	No use	No use
8	CTS, Clear To Send	No use	No use
9	RI, Ring Indicator	No use	No use
10	GND_EARTH	No use	No use

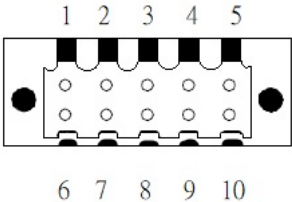

1.7.17 Flexible IO – USB3.0x2 & COMx2(RS232/422/485) & LAN1(AX93519)

The Universal Serial Bus connectors are compliant with USB 3.0 (5Gb/s), providing ideal interfaces for installing USB peripherals such as scanners, cameras and other USB devices.

Pins	Signal USB Port 0	Pins	Signal USB Port 1
1	USB_VCC (+5V level standby power)	1	USB_VCC (+5V level standby power)
2	USB_Data2-	2	USB_Data3-
3	USB_Data2+	3	USB_Data3+
4	GND	4	GND
5	SSRX2-	5	SSRX3-
6	SSRX2+	6	SSRX3+
7	GND	7	GND
8	SSTX2-	8	SSTX3-
9	SSTX2+	9	SSTX3+



The system has two serial ports. COM1~COM2 are RS-232/422/485 ports.

*RS-232/422/485 can be configured via BIOS settings

※COM1,COM2

Pins	RS-232	RS-422	RS-485
1	DCD, Data Carrier Detect	TX-	Data-
2	RXD, Receive Data	TX+	Data+
3	TXD, Transmit Data	RX+	No use
4	DTR, Data Terminal Ready	RX-	No use
5	GND, Ground	No use	No use
6	DSR, Data Set Ready	No use	No use
7	RTS, Request To Send	No use	No use
8	CTS, Clear To Send	No use	No use
9	RI, Ring Indicator	No use	No use

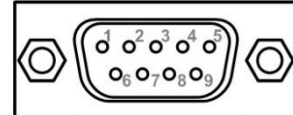

The system has two RJ-45 connectors: LAN1 Ethernet connection can be established by plugging one end of the Ethernet cable into this RJ-45 connector and the other end (phone jack) to a 1000/100/10-Base-T hub.

Pins	1000 Base-T	100/10 Base-T	Descriptions
L1	BI_DA+	TX+	Bidirectional or Transmit Data+
L2	BI_DA-	TX-	Bidirectional or Transmit Data-
L3	BI_DB+	RX+	Bidirectional or Receive Data+
L4	BI_DC+	N.C.	Bidirectional or Not Connected
L5	BI_DC-	N.C.	Bidirectional or Not Connected
L6	BI_DB-	RX-	Bidirectional or Receive Data-
L7	BI_DD+	N.C.	Bidirectional or Not Connected
L8	BI_DD-	N.C.	Bidirectional or Not Connected
A	Active Link LED (Yellow) Off: No link Blinking: Data activity detected		
B	Speed LED 1000: Orange 100: Green 10: OFF		

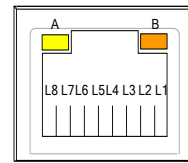

1.7.18 Riser Card- PCIe x16 Gen3 & 3 PCIe x4 Gen 3(AX96410)

Specification

- 1 PCIe x16 Gen3 + 3 PCIe x4 Gen3
- 1 x on board USB2.0 wafer
- 1 x system fan connectors
- 1 x 24V power connector (black, ATX1, for Axiomtek's device only)
- 1 x 12V power connector (white, ATX2, for Axiomtek's device only)



Note: Please refer to chapter 1.2.2 for the maximum power rating limitation of expansion slots.

Internal USB Wafer connector (CN1)

These are 5x1-Pin P=2.0mm headers for USB 2.0 interface.

Pins	Signals
1	+5V_DUAL
2	USB-
3	USB+
4	GND
5	GND

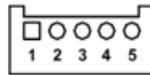

Fan Connectors (FAN1~FAN2)

This motherboard has two fan connectors. Find fan speed option(s) at BIOS Setup Utility: Advanced\HW Monitor\PC Health Status.

The FAN1~2 (4x1-Pin P=2.54mm) is for the system fan connectors.

Pins	Signals
1	GND
2	+12V
3	FAN Speed Detection
4	FAN Speed Control



Expansion Power Input Connectors (ATX1 And ATX2)

This ATX2 connector for slot card use. (White color)

Pins	Signals
1	GND
2	GND
3	+12V
4	+12V

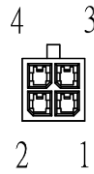

※ ATX1 is reserved for Axiomtek's device use only.

Temperature Sensor Source Select (JP1)

Use these jumpers (3x1-Pin P=2.54mm) to set temperature sensor source to operate form external or onboard mode.

Onboard Sensor (Default) 1-2 close

Function	Setting
1	On Board Thermistor
2	GND
3	Reserved



※ Pin 3 is reserved for Axiomtek's device use only..

1.7.19 Riser Card- PCIe x16 Gen3 & 1 PCIe x4 Gen 3 & 2 PCI(AX96411)

Specification

- 1 PCIe x16 Gen3 + 1 PCIe x4 Gen3 + 2 PCI
- 1 x on board USB2.0 wafer
- 1 x system fan connectors
- 1 x 24V power connector (black, ATX1, for Axiomtek's device only)
- 1 x 12V power connector (white, ATX2, for Axiomtek's device only)



Note: Please refer to chapter 1.2.2 for the maximum power rating limitation of expansion slots.



Note: AX96411 can't support -12V voltage.

Internal USB Wafer connector (CN1)

These are 5x1-Pin P=2.0mm headers for USB 2.0 interface.

Pins	Signals
1	+5V_DUAL
2	USB-
3	USB+
4	GND
5	GND

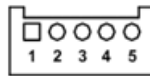

Fan Connectors (FAN1~FAN2)

This motherboard has two fan connectors. Find fan speed option(s) at BIOS Setup Utility: Advanced\HW Monitor\PC Health Status.

The FAN1~2 (4x1-Pin P=2.54mm) is for the system fan connectors.

Pins	Signals
1	GND
2	+12V
3	FAN Speed Detection
4	FAN Speed Control



Expansion Power Input Connectors (ATX1 And ATX2)

This ATX2 connector is for slot card use. (White color)

Pins	Signals
1	GND
2	GND
3	+12V
4	+12V

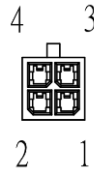

※ ATX1 is reserved for Axiomtek's device use only.

Temperature Sensor Source Select (JP1)

Use these jumpers (3x1-Pin P=2.54mm) to set temperature sensor source to operate form external or onboard mode.

Onboard Sensor (Default) 1-2 close

Function	Setting
1	On Board Thermistor
2	GND
3	Reserved



※ Pin 3 is reserved for Axiomtek's device use only.

This page is intentionally left blank.

SECTION 2

HARDWARE INSTALLATION

The IPC974-519-FL is convenient for your various hardware configurations, such as CPU (Central Processing Unit), memory module, HDD (Hard Disk Drive) and PCIe/PCI card. Chapter 2 will show you how to install these hardware parts.

2.1 Installing the Processor

The Intel® Xeon and Core™ i7/i5/i3 processors are available as a boxed processor for the IPC974-519-FL system. Intel® recommends the processors should be installed by a qualified computer professional, since this electronic device may cause serious damage to the installer, system and processor if installed improperly.

Important Notes Before attempting to install a new processor, carefully review the documentation that came with your system and make sure that you will not be voiding your warranty by opening the computer or replacing your processor.

Instructions:

1. Make sure that your system can accommodate the Intel® Core™ i7/i5/i3/Celeron® Processors that you want to install. Check for CPU card, BIOS, and thermal compatibility by consulting the manufacturer's documentation for the system, or by contacting the vendor if necessary. This processor should only be installed in systems supporting the Intel® Xeon and Core™ i7/i5/i3/Celeron® Processors.
2. Obtain access to your processor socket as described in the documentation for your system.
3. If the cooling solution prevents you from accessing the processor socket, you may need to remove it. Instructions on how to remove your cooling solution should be provided in the documentation that came with the system.

Procedure of Installation:

- Step 1** Turn off the system.
- Step 2** Disconnect the power connector.
- Step 3** Loosen screws to remove the heatsink cover from the chassis.



- Step 4** After opening the heatsink cover, you can locate the CPU socket as marked. Align pins of the CPU with pin holes of the socket. Beware of the CPU's orientation by aligning the arrow mark on the CPU with the arrow key on the socket. Remove the Mylar before you install the CPU into the socket.

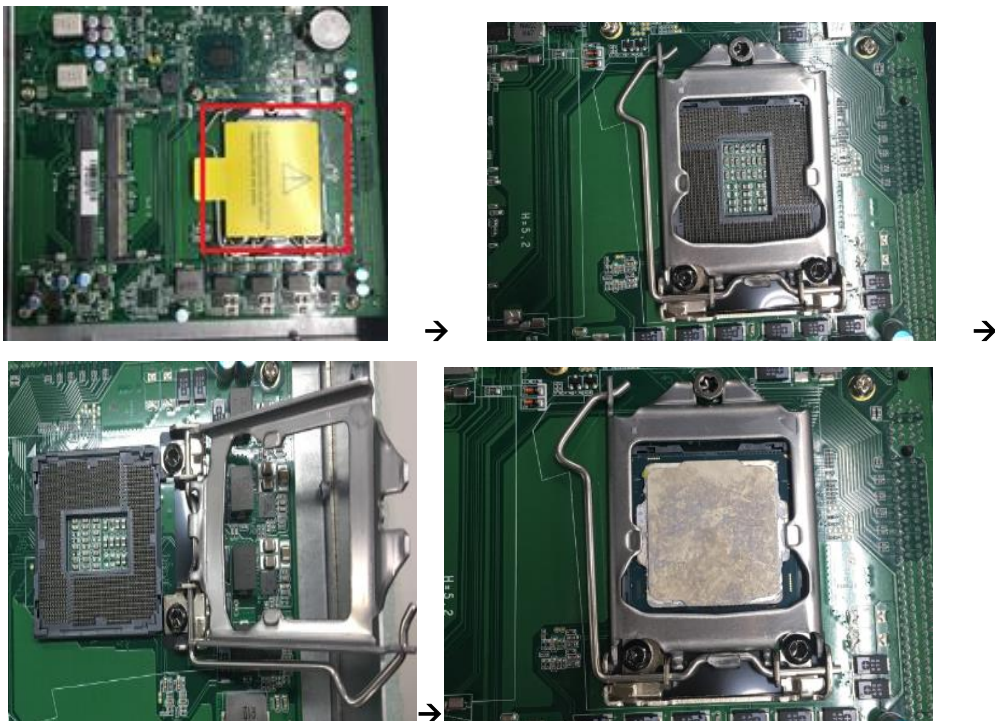

Step 5 Apply thermal grease on top of the CPU



Step 6 After installing all components, close the heatsink cover back to the chassis and fasten all screws.



2.2 Installing the Memory Module

Step 1 Turn off the system.

Step 2 Disconnect the power connector.

Step 3 Loosen screws to remove the heatsink cover from the chassis.



- Step 4** Install the SO-DIMM (small outline dual in-line memory module) into the socket and push it firmly down until it is fully seated. The socket latches are clipped onto the edges of the memory module.



- Step 5** After installing the memory modules, close the heatsink cover back to the chassis and fasten all screws. The installation is complete.

2.3 Installing the Hard Disk Drive

The IPC974-519-FL offers a convenient drive bay module for users to install HDD. The system offers up to four 2.5" Hard Disk Drives for installation. Please follow the steps:

- Step 1** Turn off the system.
- Step 2** Disconnect the power connector.
- Step 3** Unscrew the three screws and separate the bracket from the HDD tray.



- Step 4** Open the HDD tray.

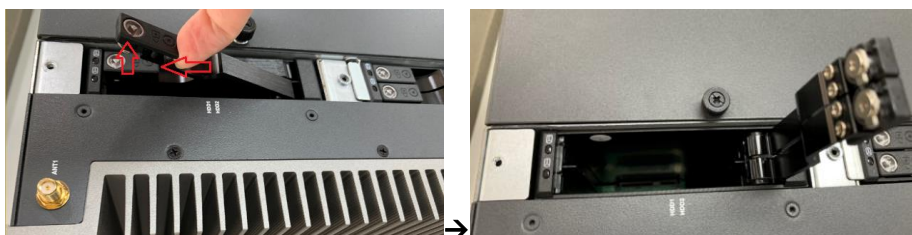

- Step 5** Align the connector of the HDD/SSD with the SATA slot of main board. Then, insert the HDD into the HDD tray.



Note: When using 7mm height HDD/SDD, please take the HDD spacer out of the accessory box and follow the following steps to stick it on HDD/SSD.

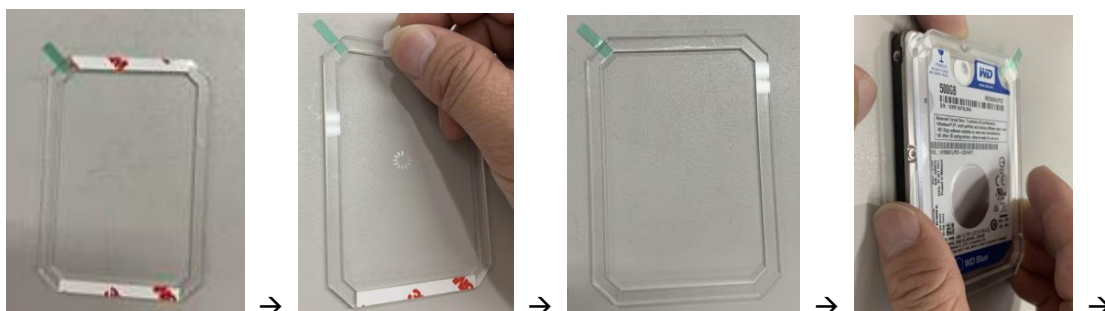

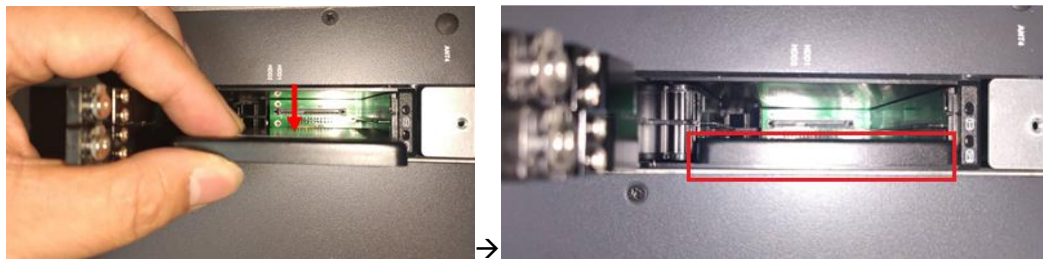
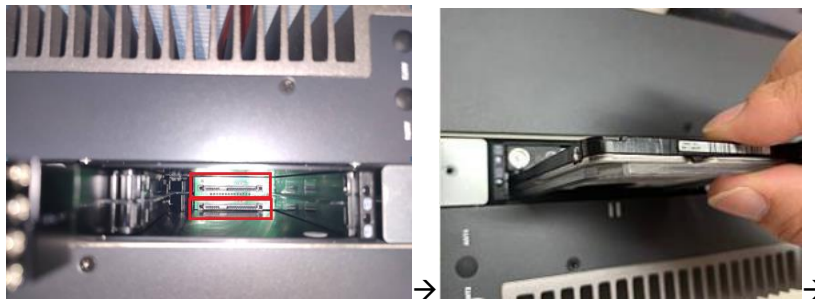

Step 6 Screw the bracket. The installation is complete.





Note: The description of 2.5" HDD Tray (2in1) is as shown below.

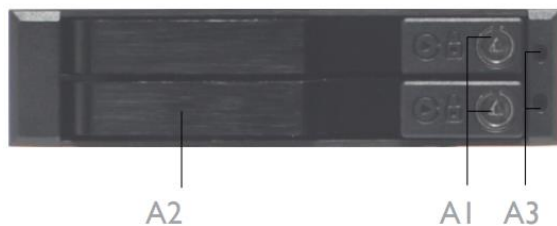

A1 : Triangular key lock
 A2 : Aluminum bezel
 A3 : Power & HDD access LED indication
 Power ON : Solid Green
 Accessing : Orange blinking

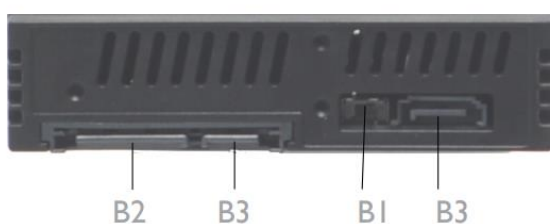

B1 : LED Switch ON : working status(see A3)
 LED Switch OFF : Solid Green for
 Power on and HDD accessing
 B2 : 15pin SATA Power connector.
 B3 : 7pin SATA data signal connector

2.4 Installing the PCI or PCIe Card

IPC974-519-FL provides four PCI or PCIe slots for expansion. The procedure of installing the fan module and PCI / PCIe expansion card into system is instructed below.

- Step 1** Turn off the system.
- Step 2** Disconnect the power connector.
- Step 3** Unscrew the thumbscrew and separate the cover from the expansion box.



2.4.1 Installing PCI or PCIe add-in card

Step 1 Locate the PCI or PCIe slots which you want to add the card in, and remove the holder bracket and slot bracket.



Step 2 Align the PCI or PCIe card with the slot, press the card into the slot until it is firmly seated and screw it.

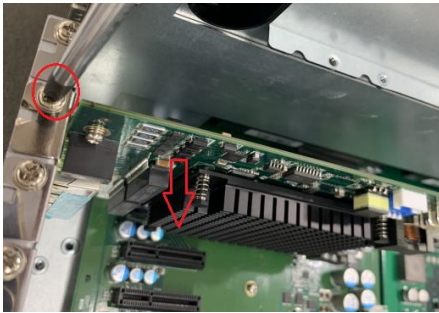

Step 3 Fasten the below bracket in chassis with standard height (111mm) add-in cards.

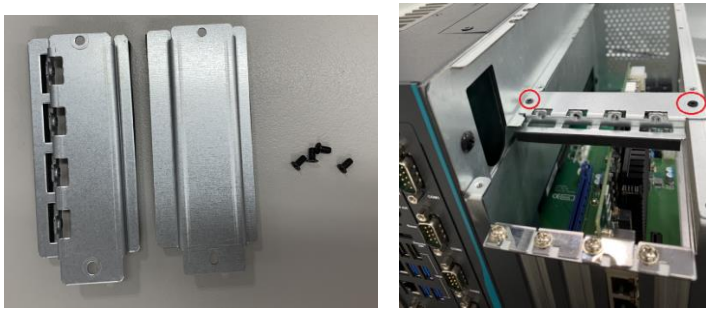

Step 4 IPC974-519 reserves two locations for the second holder bracket; please screw it against the length of the add-in card.



Step 5 IPC974-519 offers 3 types of extension holder brackets; please take the brackets and screws from the accessory box.



Step 6 Remove the holder bracket and connect the extension holder bracket. The procedure is illustrated below.

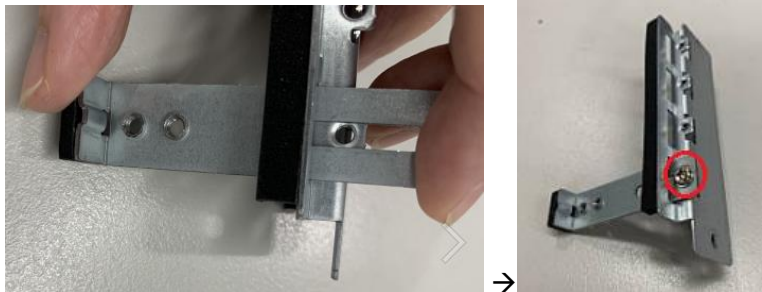

Or

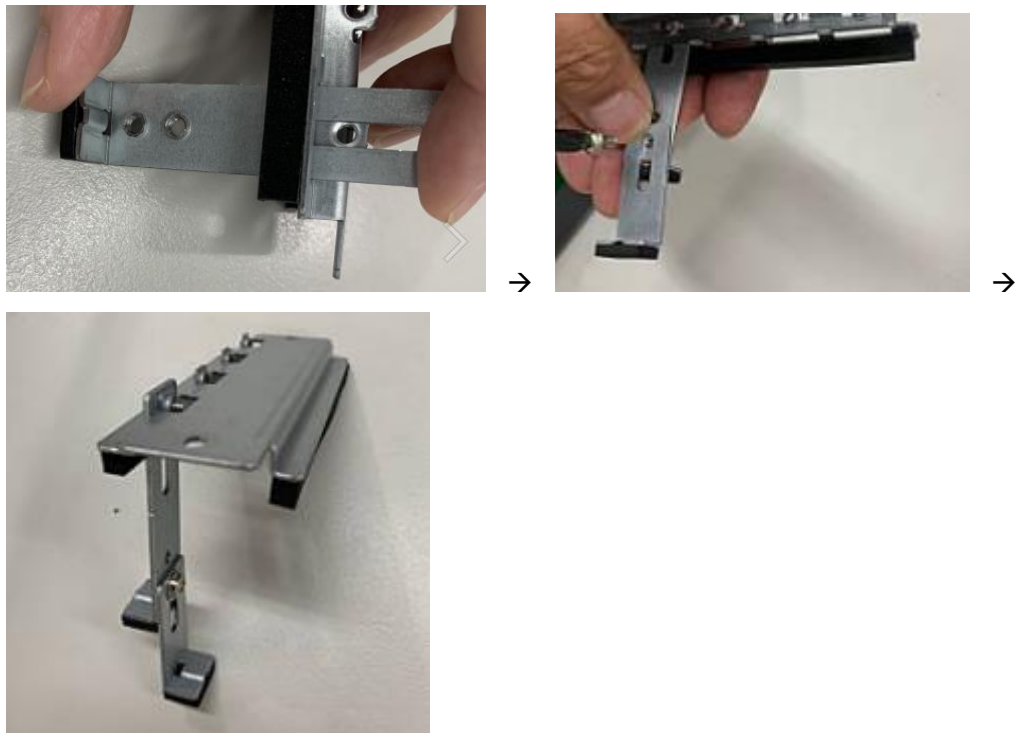

Step 7 Fasten the first holder bracket in the chassis, adjust the screw position of the extension bracket to fix the add-in card, and then screw it.

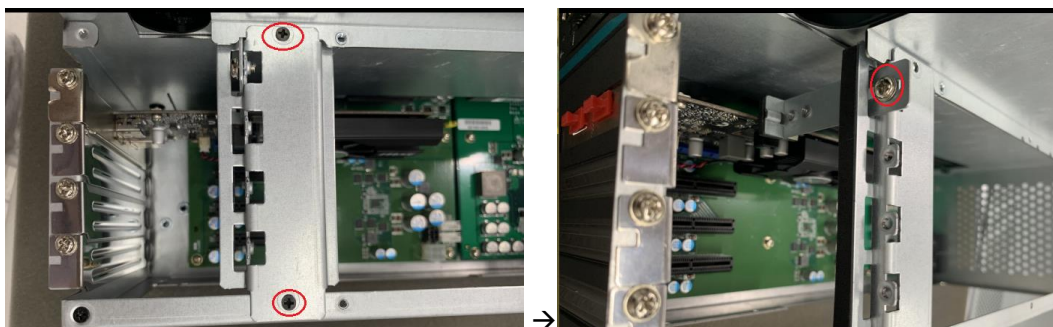

Step 8 Close the cover back to the chassis and fasten all screws. The installation is complete.



2.4.2 Installing graphics card

Step 1 Remove the PCIe x16 holder bracket and slot bracket.

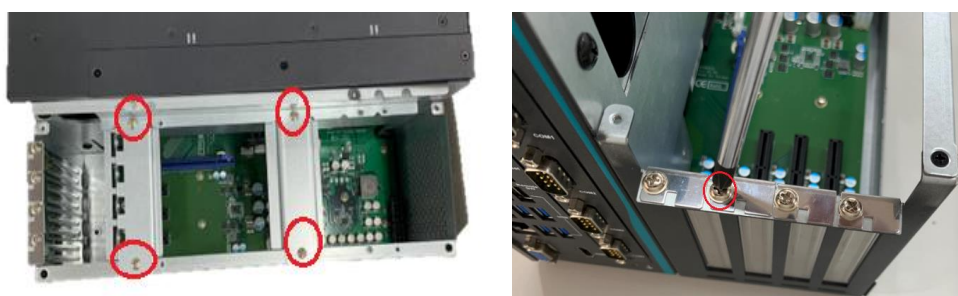

- Step 2** Plug two graphics card power cables in AX98268. (Please refer to the note of maximum power loading limitation.)

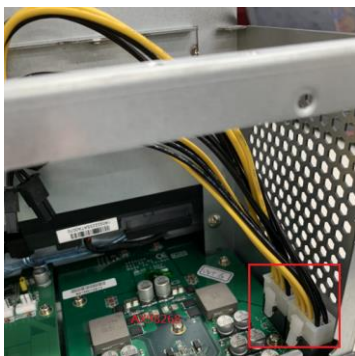

- Step 3** Align graphics card with the slot, press the card into the slot until it is firmly seated and screw it.



- Step 4** Plug two graphics cables into AX98268 power board and graphics card.

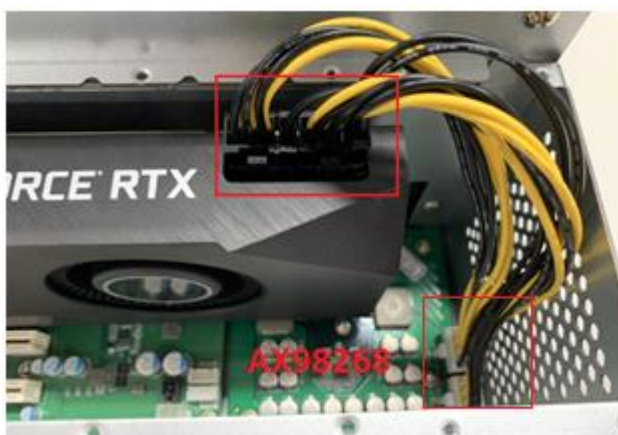

Step 5 Fasten the holder bracket in chassis.

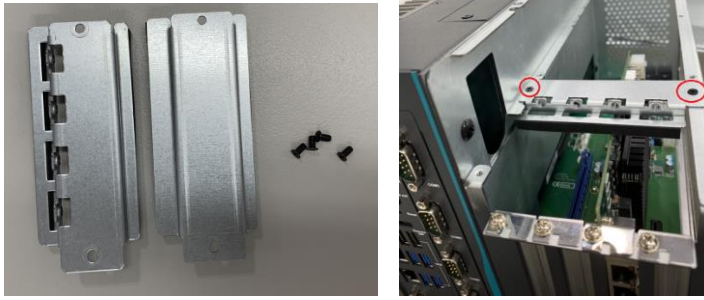

Step 6 Close the cover back to the chassis and fasten all screws. The installation is complete.



Note: The maximum power rating for expansion slots at 60 °C cannot exceed the following value:

The maximum power loading of +3.3V+5V+12V<150W

The maximum power loading of +3.3V+5V+12V<480W (w/AX98268 300W power board)

2.4.3 The length limitation of an add-in card

IPC974-519 supports four full-size PCI/PCIe add-in cards. The following figures show the limitation of an add-in card in different configuration.

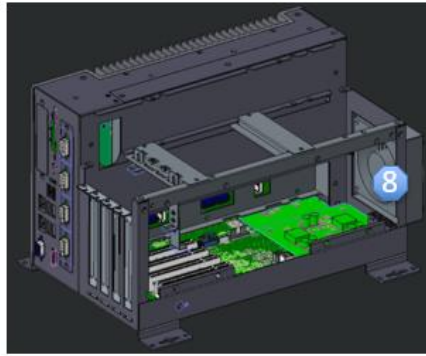
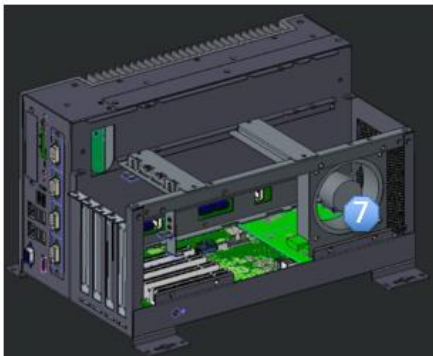
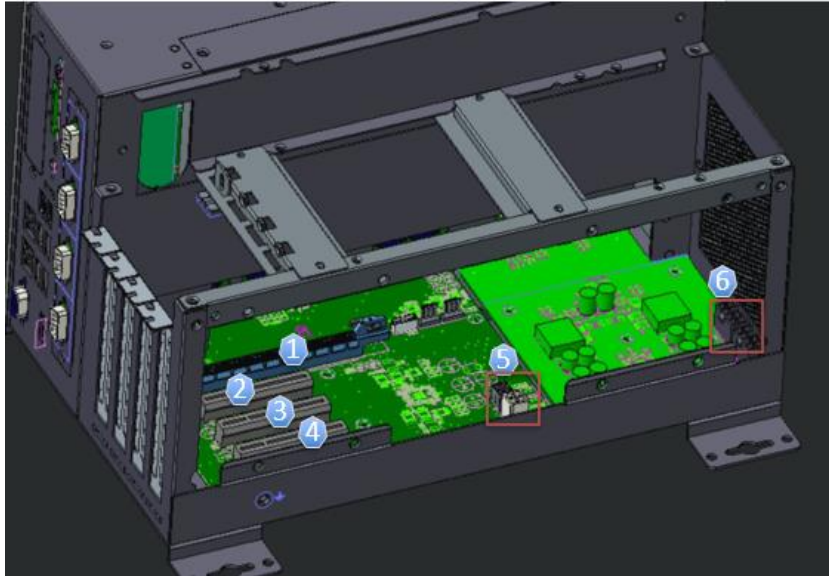

No.	Description	No.	Description
1	Slot 1: PCIe x 16	5	Power connector of AX96410 or AX96411(riser)
2	Slot 2: PCIe x4	6	Power connector of AX98268(power board)
3	Slot 3: PCIe x4 slot or PCI	7	Internal fan module
4	Slot 4: PCIe x4 slot or PCI	8	External fan module

 **Note:** Please note that below dimension is the maximum length for add-on card with I/O bracket.

 **Note:** Considering heat dissipation potential, a space of 20mm must be left between add-on card and system.

Fan module is un-installed.

	Slot 1 (PCIe x16)	Slot 2 (PCIe x4)	Slot 3 (PCI x4 or PCI)	Slot 4 (PCI x4 or PCI)
height	49.48-114.78 (mm)	49.48-114.78 (mm)	49.48-114.78 (mm)	49.48-114.78 (mm)
width	20.32(mm)	20.32(mm)	20.32(mm)	20.32(mm)

The following shows each slot's max. length for add-in card in the system with different configurations.

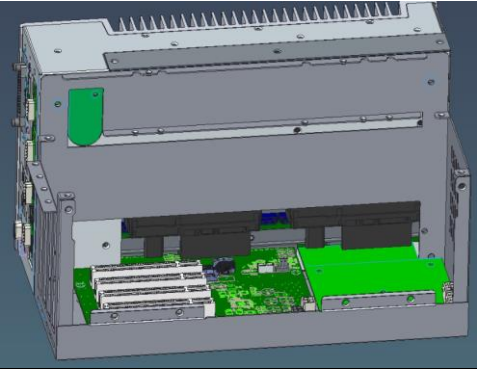
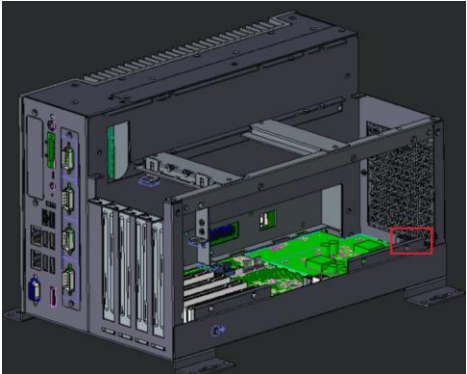
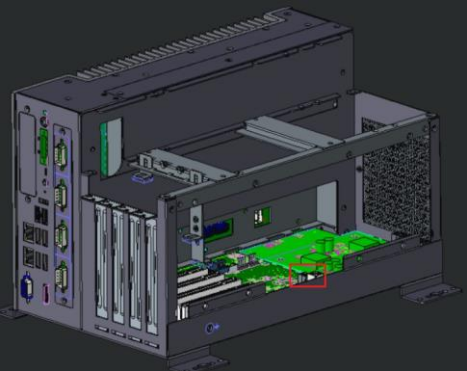
1) Both AX98268 and riser card's power cables are un-installed.	325.00(mm)	325.00(mm)	325.00(mm)	325.00(mm)	
2) Only AX98268's power board is installed.	325.00(mm)	325.00(mm)	310.00(mm)	310.00(mm)	
3) Only riser card's power cable is installed.	325.00(mm)	325.00(mm)	325.00(mm)	185.00 (mm)	

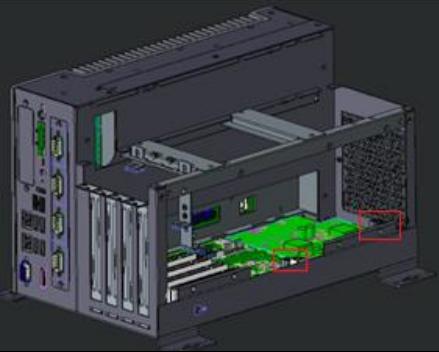
4)	325.00(mm)	325.00(mm)	310.00(mm)	185.00 (mm)
Both AX98268 and riser card's power cables are installed.				

Internal fan module is installed.

	Slot 1 (PCIe x16)	Slot 2 (PCIe x4)	Slot 3 (PCI x4 or PCI)	Slot 4 (PCI x4 or PCI)
height	49.48- 114.78 (mm)	49.48- 114.78 (mm)	49.48-114.78 (mm)	49.48-114.78 (mm)
width	20.32(mm)	20.32(mm)	20.32(mm)	20.32(mm)

The following shows each slot's max. length for add-in card in the system with different configurations.

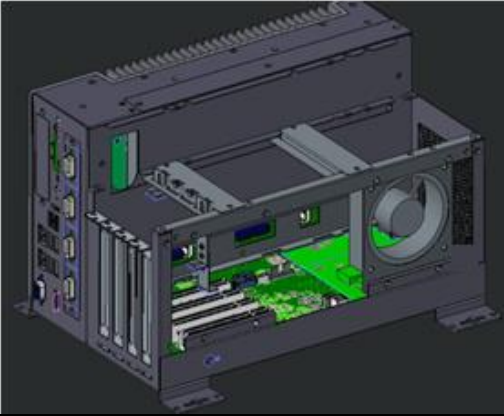
1)	325.00(mm)	325.00(mm)	191.14(mm)	191.14(mm)
Both AX98268 and riser card's power cables are un-installed.				
2)	325.00(mm)	325.00(mm)	191.14(mm)	191.14(mm)

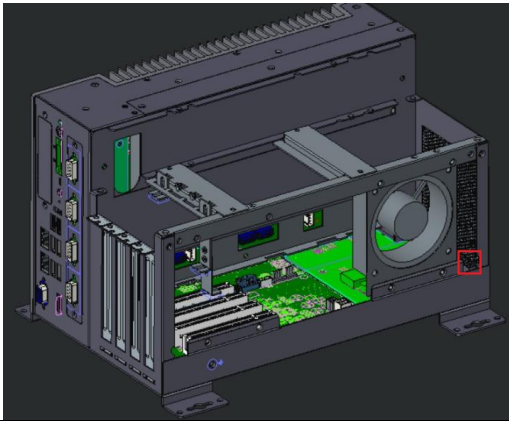
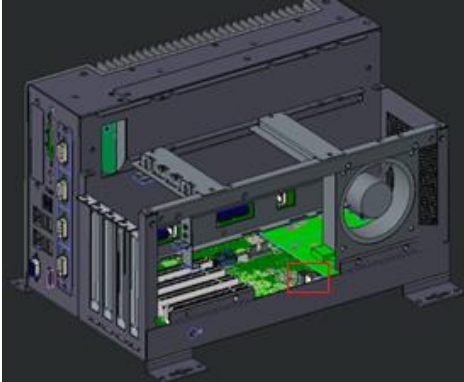
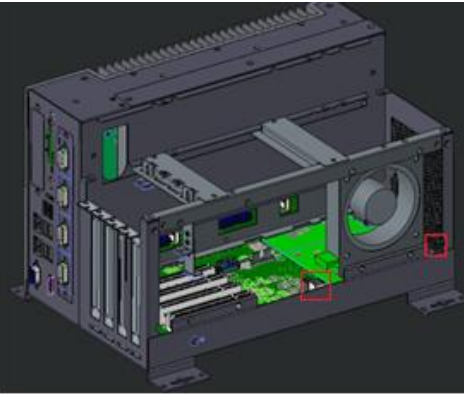
<p>Only AX98268's power board is installed.</p>				
<p>3) Only Riser card's power cable is installed.</p>	<p>325.00(mm)</p>	<p>325.00(mm)</p>	<p>185.00(mm)</p>	<p>185.00(mm)</p>
<p>4) Both AX98268 and riser card's power cables are installed.</p>	<p>325.00(mm)</p>	<p>325.00(mm)</p>	<p>191.14 (mm)</p>	<p>185.00(mm)</p>
				
				

External fan module is installed.

	Slot 1 (PCIe x16)	Slot 2 (PCIe x4)	Slot 3 (PCI x4 or PCI)	Slot 4 (PCI x4 or PCI)
height	49.48-114.78 (mm)	49.48-114.78 (mm)	49.48-114.78 (mm)	49.48-114.78 (mm)
width	20.32(mm)	20.32(mm)	20.32(mm)	20.32(mm)
<p>The following shows each slot's max. length for add-in card in the system with</p>				

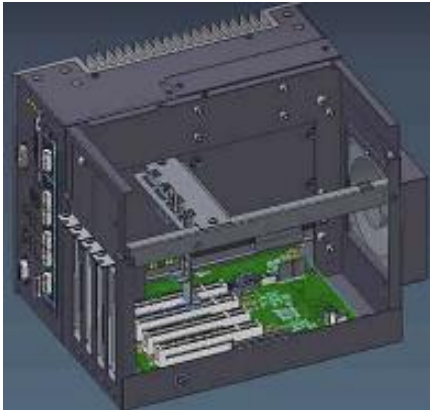
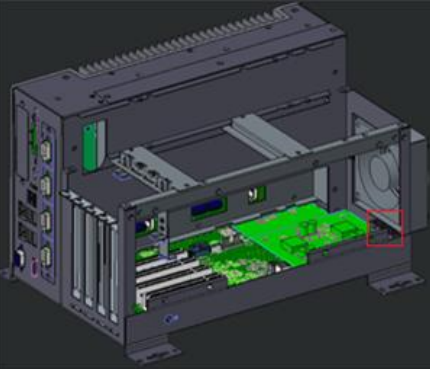
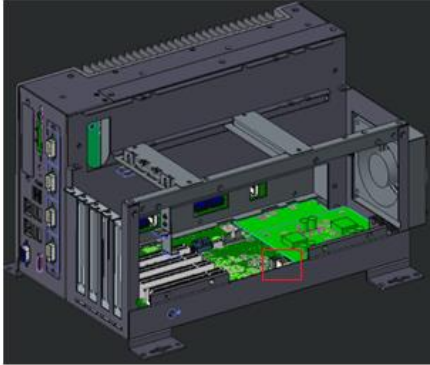
different configurations.				
<p>1)</p> <p>Both AX98268 and riser card's power cables are un-installed.</p>	325.00(mm)	325.00(mm)	325.00(mm)	325.00(mm)
				
<p>2)</p> <p>Only AX98268's power board is installed.</p>	325.00(mm)	325.00(mm)	310.00(mm)	310.00(mm)
				
<p>3)</p> <p>Only Riser card's power cable is installed.</p>	325.00(mm)	325.00(mm)	325.00(mm)	185.00(mm)
				
<p>4)</p>	325.00(mm)	325.00(mm)	310.00(mm)	185.00(mm)

Both AX98268 and riser card's power cables are installed.

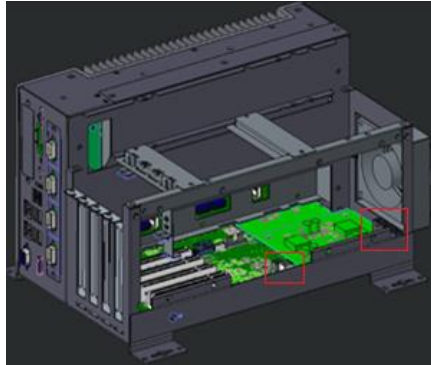

2.4.4 Installing the Fan Module

The IPC974-519-FL provides either an internal fan module or an external fan module for optional selection. The procedure of installing the fan module into system is instructed below.

Step 1 Turn off the system.

Step 2 Disconnect the power connector.

Step 3 Unscrew the thumbscrew and separate the cover from the expansion box.



Step 4 Screw the fan and plug the fan cable to fan connector on the riser.

Internal fan module

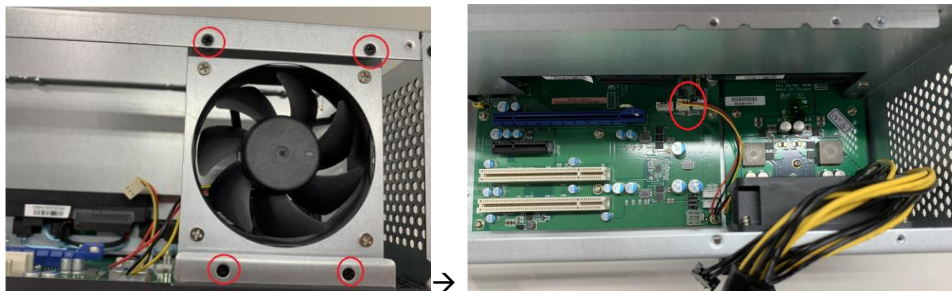

External fan module

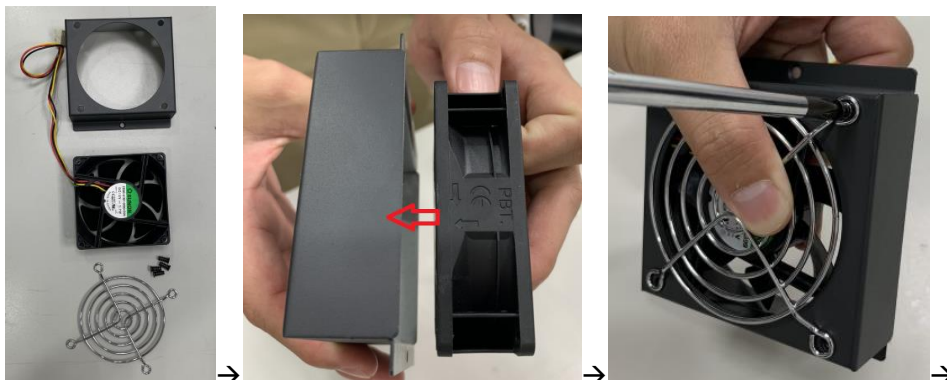

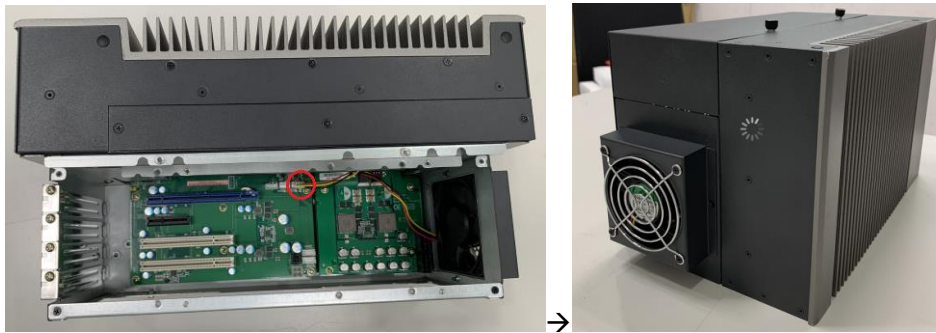
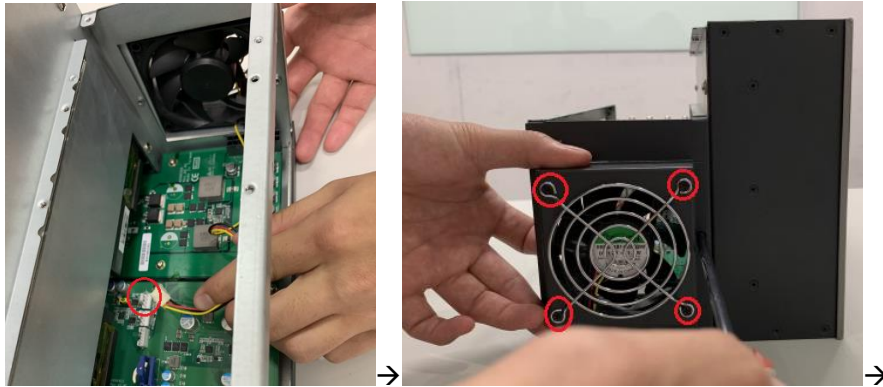

2.5 Installing the WIFI Module

The IPC974-519-FL comes with a Mini card slot and a USB connector for users to install a wireless LAN card. Please refer to the following instructions and illustrations for the installation of the wireless LAN.

Step 1 Turn off the system.

Step 2 Disconnect the power connector.

Step 3 Loosen screws to remove the heatsink cover from the chassis.



Step 4 Insert the wireless LAN card into the slot and push it down firmly. Then screw the card tightly to the mainboard.

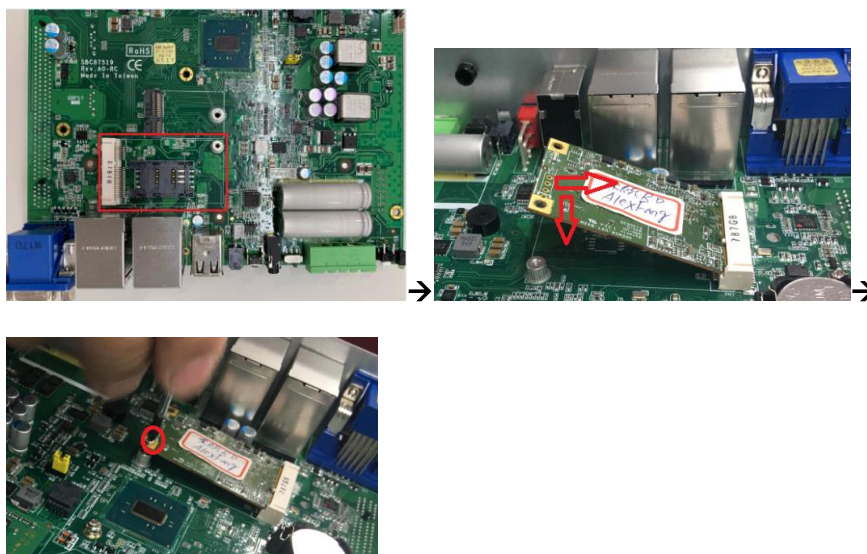

Step 5 Remove the antenna plug from the top of back cover, and then install the antenna on the antenna connector. The installation is complete.



 **Note:** Please use the supplied extended bracket when using a half-size Mini card.

2.6 Installing USB dongle kit

Step 1 Turn off the system.

Step 2 Disconnect the power connector.

Step 3 Loosen screws to remove the heatsink cover from the chassis.



Step 4 Complete the USB dongle kit as the below procedure illustrates.



Step 5 Insert the USB stick into the USB dongle kit and screw it.

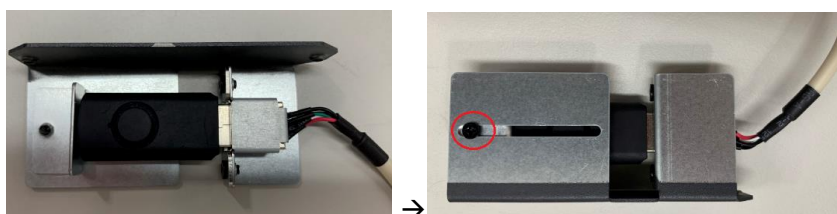

Step 6 Put the USB dongle kit inside the mini card window and screw it. The installation is complete.

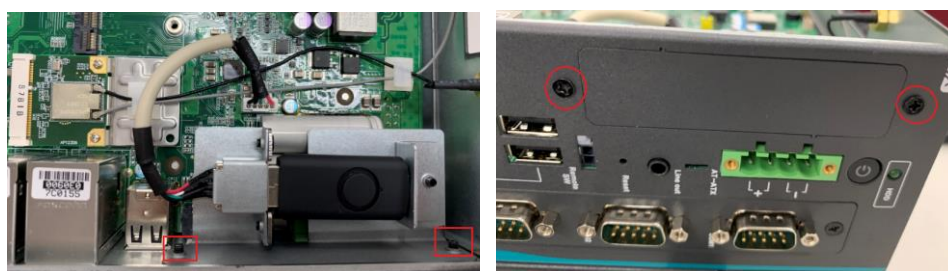

2.7 Installing foot pad

Step 1 Turn off the system.

Step 2 Disconnect the power connector.

Step 3 Take the foot pads from the accessory box. Screw the foot pads into system.

The installation is complete.



2.8 Wall mounting

IPC974-519-FL provides versatile wall mount kits for optional mounting.

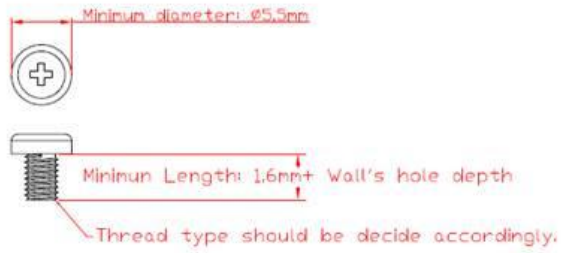
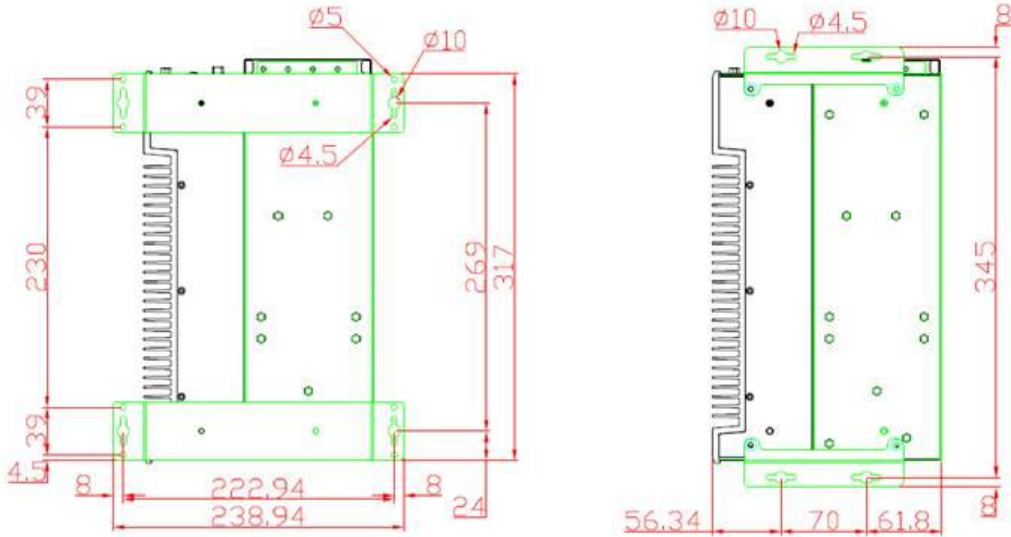

Step 1 Turn off the system.

Step 2 Disconnect the power connector.

Step3 Remove foot pads.

Step4 Assemble the wall mount bracket to the chassis, and fix the screws.

Step5 Wall mounting installation is complete.

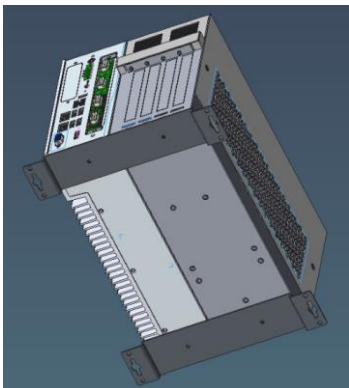

SECTION 3

AMI BIOS UTILITY

The AMI UEFI BIOS provides users with a built-in setup program to modify basic system configuration. All configured parameters are stored in a 16MB flash chip to save the setup information whenever the power is turned off. This chapter provides users with detailed description about how to set up basic system configuration through the AMI BIOS setup utility.

3.1 Starting

To enter the setup screens, follow the steps below:

1. Turn on the computer and press the key immediately.
2. After you press the key, the main BIOS setup menu displays. You can access the other setup screens from the main BIOS setup menu, such as the Advanced and Chipset menus.



Note: If your computer cannot boot after making and saving system changes with Setup, you can restore BIOS optimal defaults by setting JP1 (see section 1.6.2).

It is strongly recommended that you should avoid changing the chipset's defaults. Both AMI and your system manufacturer have carefully set up these defaults that provide the best performance and reliability.

3.2 Navigation Keys

The BIOS setup/utility uses a key-based navigation system called hot keys. Most of the BIOS setup utility hot keys can be used at any time during the setup navigation process. These keys include <F1>, <F2>, <Enter>, <ESC>, <Arrow> keys, and so on.



Note: Some of the navigation keys differ from one screen to another.

Hot Keys	Description
→← Left/Right	The Left and Right <Arrow> keys allow you to select a setup screen.
↑↓ Up/Down	The Up and Down <Arrow> keys allow you to select a setup screen or sub-screen.
+– Plus/Minus	The Plus and Minus <Arrow> keys allow you to change the field value of a particular setup item.
Tab	The <Tab> key allows you to select setup fields.
F1	The <F1> key allows you to display the General Help screen.
F2	The <F2> key allows you to Load Previous Values.
F3	The <F3> key allows you to Load Optimized Defaults.
F4	The <F4> key allows you to save any changes you have made and exit Setup. Press the <F4> key to save your changes.
Esc	The <Esc> key allows you to discard any changes you have made and exit the Setup. Press the <Esc> key to exit the setup without saving your changes.
Enter	The <Enter> key allows you to display or change the setup option listed for a particular setup item. The <Enter> key can also allow you to display the setup sub- screens.

3.3 Main Menu

The first time you enter the setup utility, you will be in the Main setup screen. You can always return to the Main setup screen by selecting the Main tab. System Time/Date can be set up as described below. The Main BIOS setup screen is shown below.

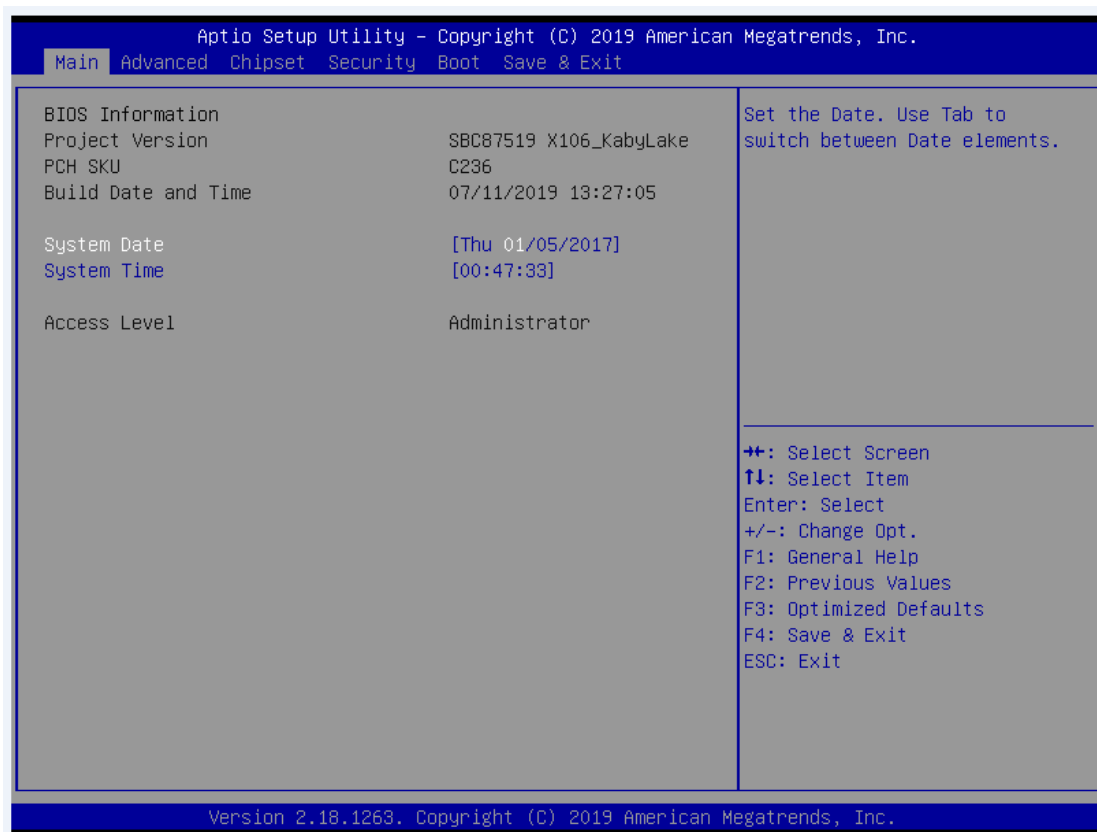

➤ System Date/Time

Use this option to change the system time and date. Highlight System Time or System Date using the <Arrow> keys. Enter new values through the keyboard. Press the <Tab> key or the <Arrow> keys to move between fields. The date must be entered in MM/DD/YY format. The time is entered in HH:MM:SS format.

3.4 Advanced Menu

- **Launch PXE OpROM**

Use this item to enable or disable the boot ROM function of the onboard LAN chip when the system boots up.

The Advanced menu also allows users to set configuration of the CPU and other system devices. You can select any of the items in the left frame of the screen to go to the sub menus:

- ▶ Hardware Monitor
- ▶ Ethercat Configuration
- ▶ Trusted Computing
- ▶ CPU Configuration
- ▶ SATA Configuration
- ▶ PCH-FW Configuration
- ▶ USB Configuration
- ▶ Module Configuration
- ▶ Serial Port(1-4) Configuration
- ▶ CSM Configuration
- ▶ AMT Configuration
- ▶ Platform Misc Configuration
- ▶ Utility Configuration

For items marked with “▶”, please press <Enter> for more options.

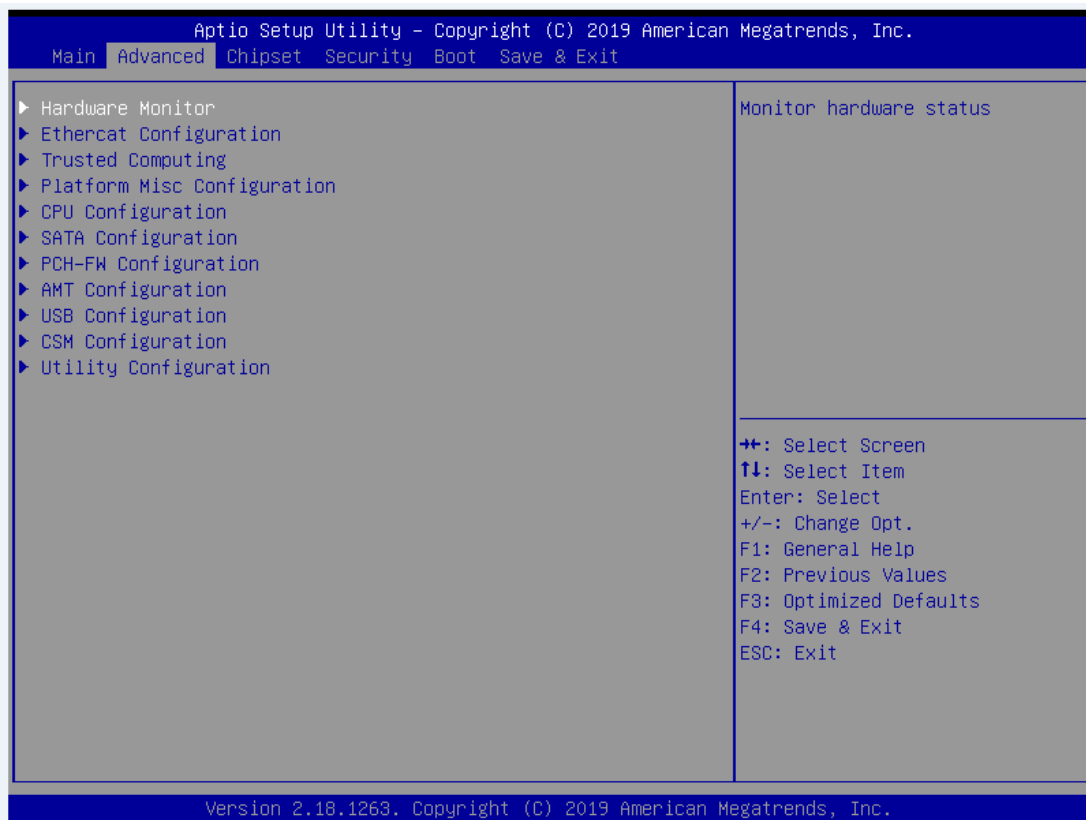

- **Hardware Monitor**

This screen monitors hardware health.

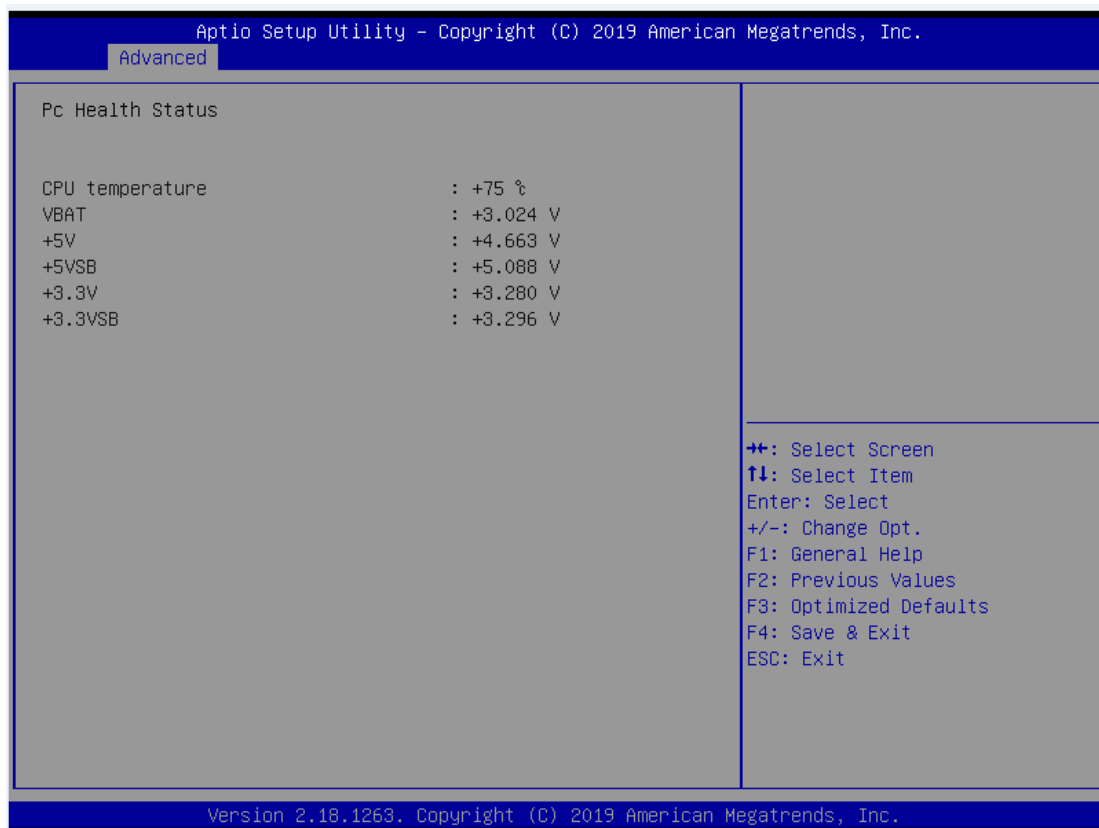

- **Ethercat Configuration**

Setting "Disable" mode in the following 5 times to support Ethercat.

ACPI configuration can be configured in ACPI Settings. A description of the selected item appears on the right side of the screen.

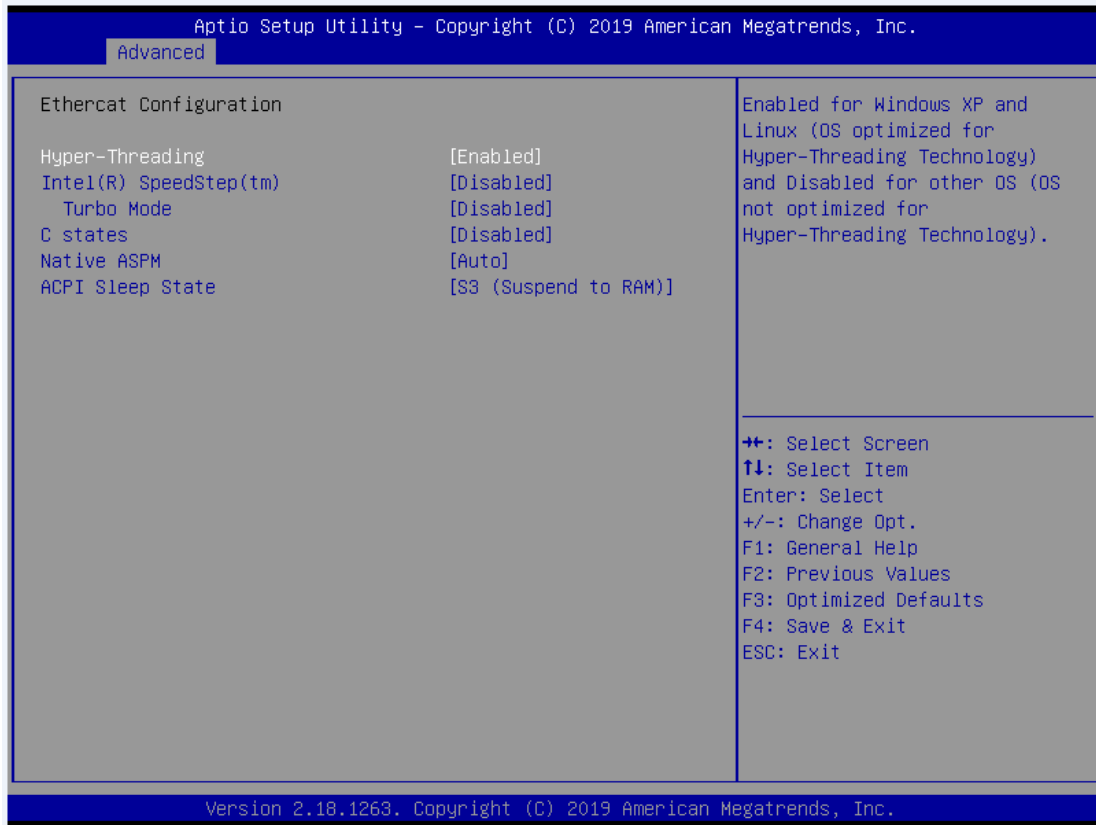

- **ACPI Sleep State**

Select the highest ACPI sleep state the system will enter when the suspend button is pressed. Configuration options are Suspend S3 only (Suspend to RAM).

- **Trusted Computing**

Select the Security Device Support to enable or disable the TPM function.

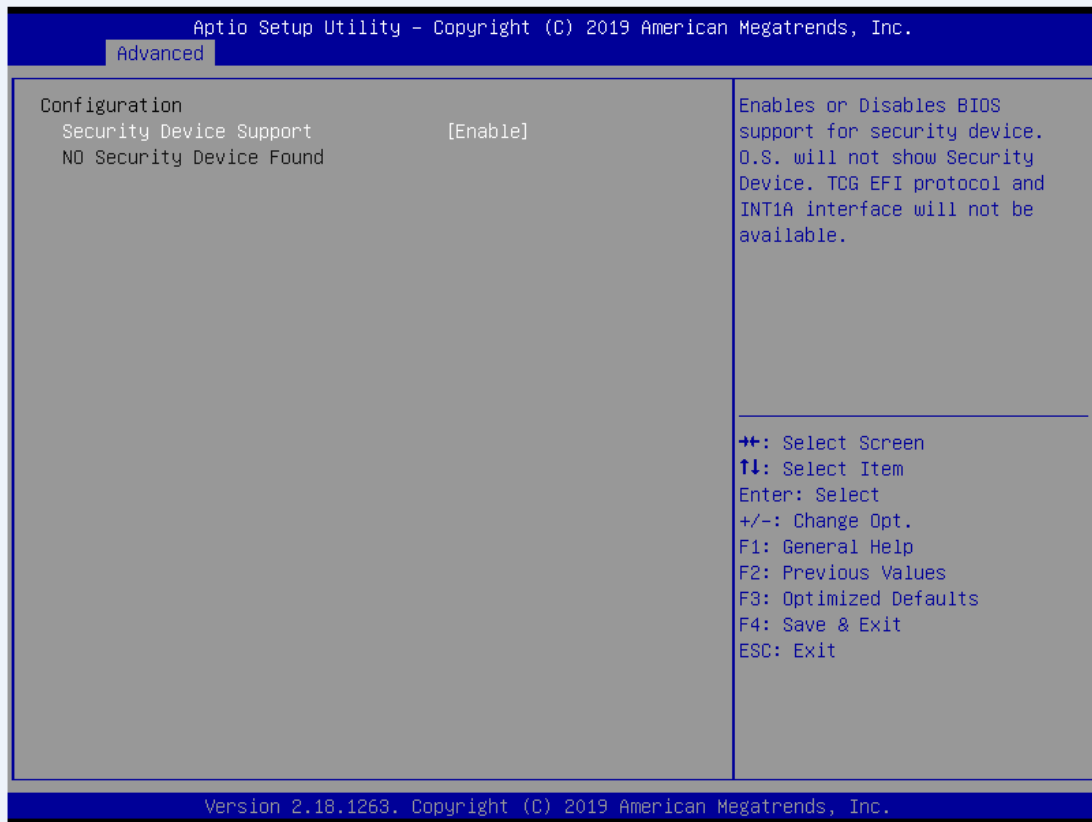

- **CPU Configuration**

This screen shows the CPU Configuration, and you can change the value of the selected option.

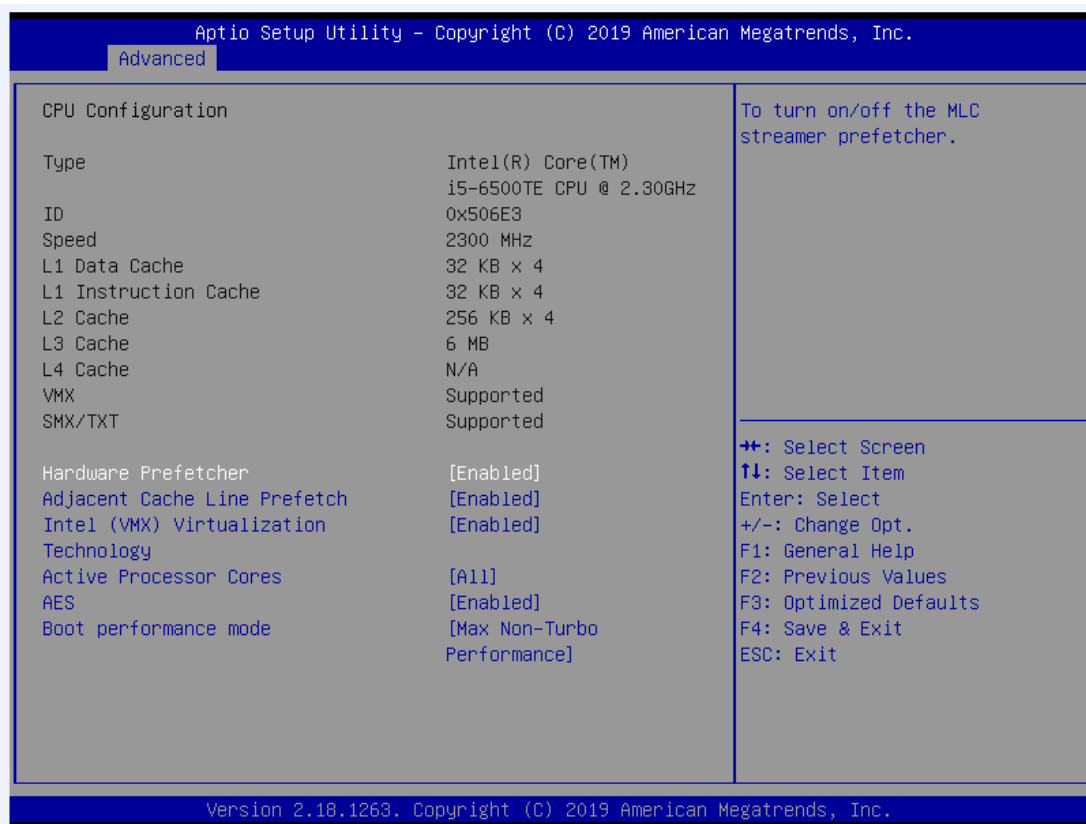

➤ **Intel Virtualization Technology**

This item allows a hardware platform to run multiple operating systems separately and simultaneously, enabling one system to virtually function as several systems.

● **SATA Configuration**

You can read the current installed hardware configurations from those SATA ports in the SATA Configuration menu. During system boot up, BIOS will detect the present SATA devices automatically.

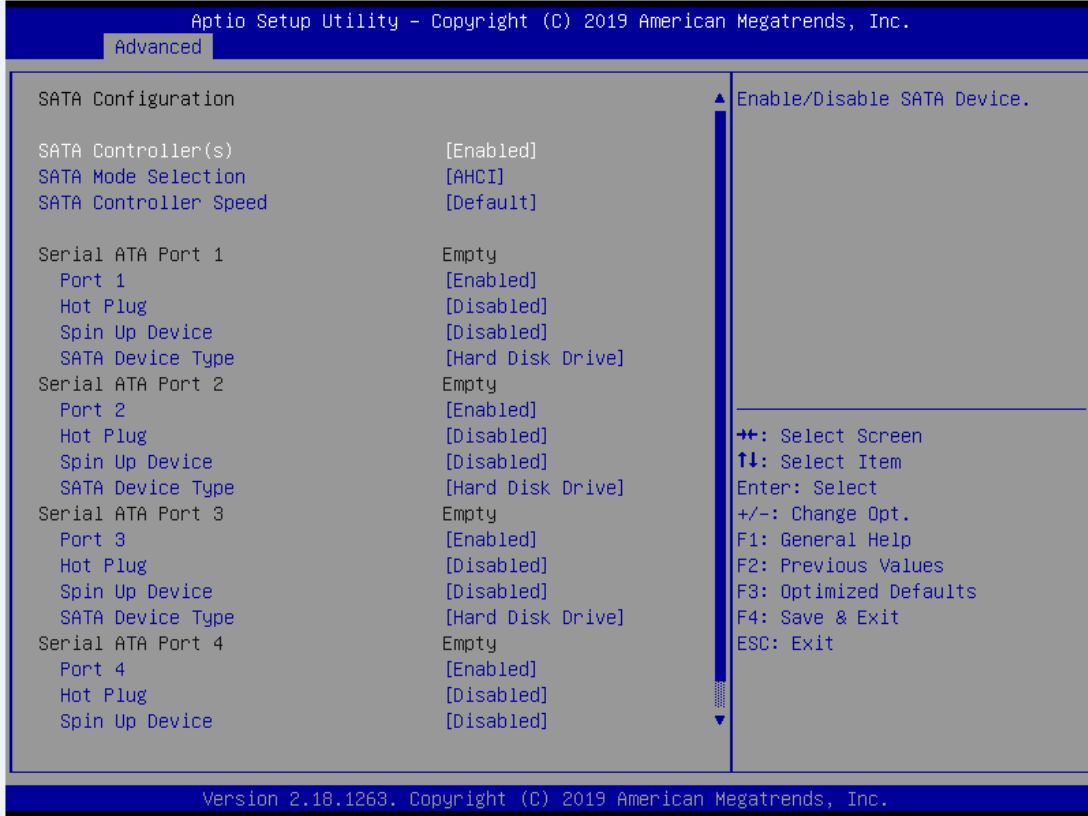

- **FCH-FW Configuration**

Display ME firmware information

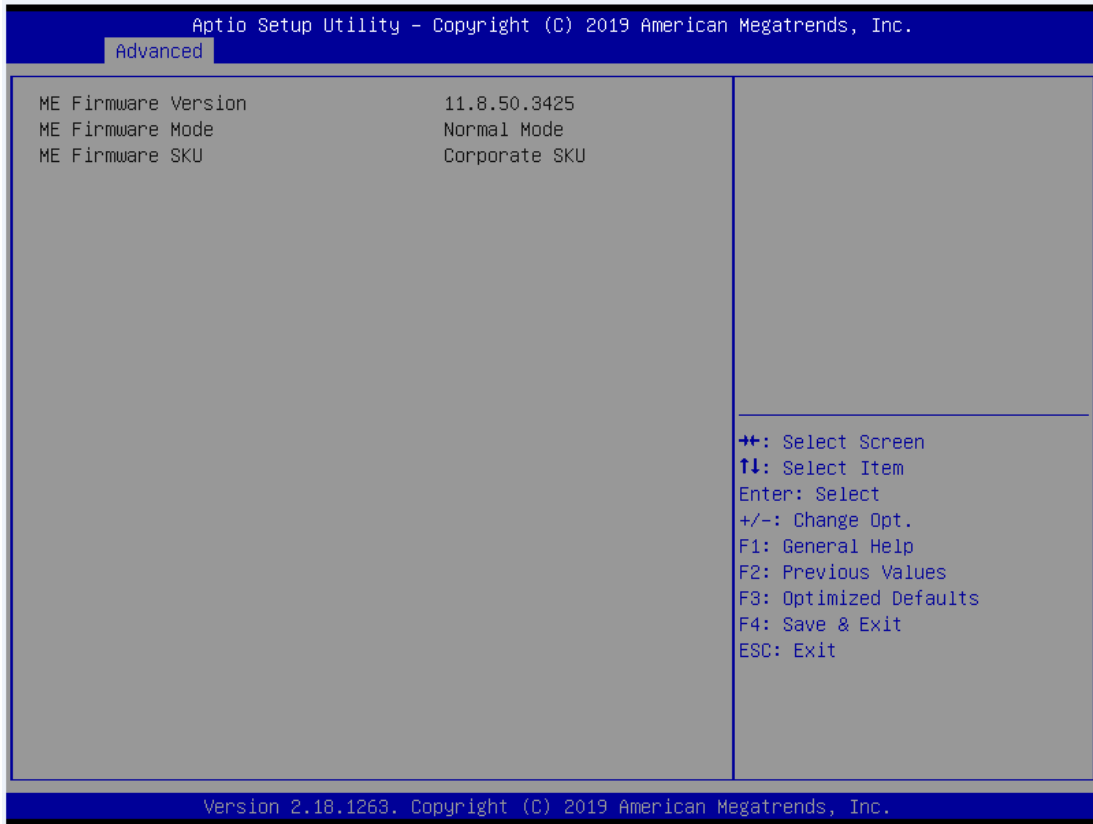

● **USB Configuration**

USB configuration can be configured here by selecting and changing each item. A description of the selected item appears on the right side of the screen.

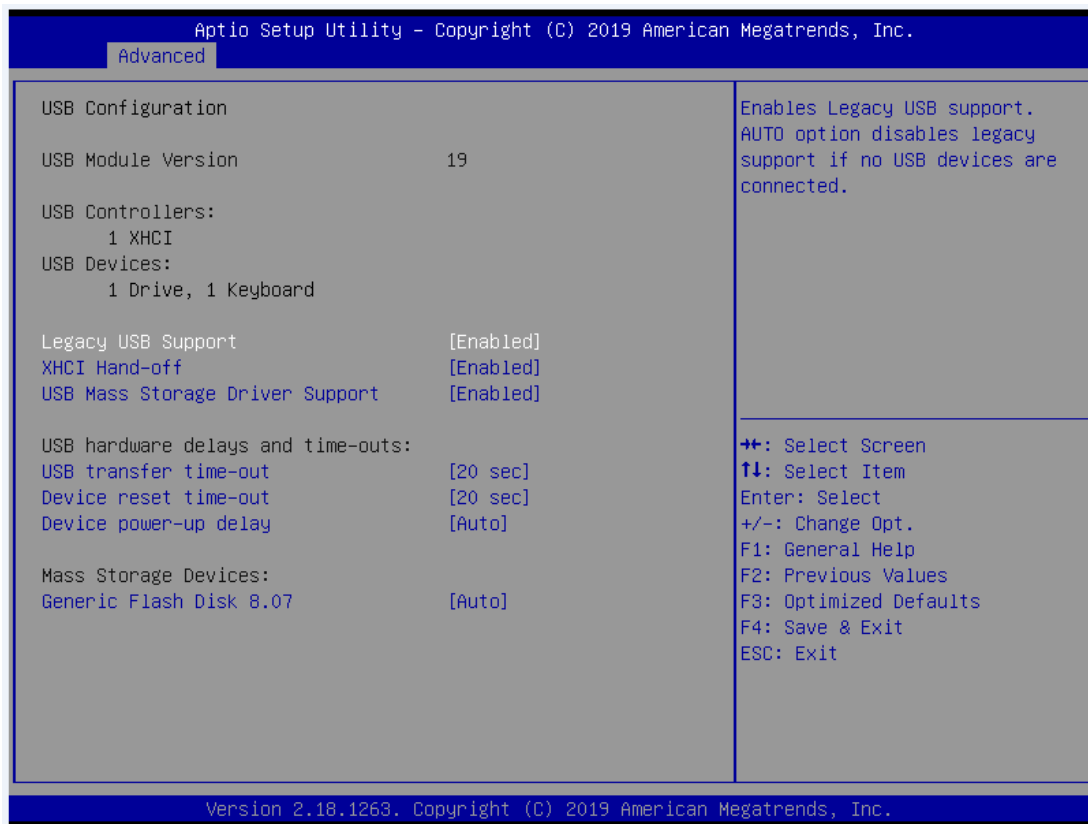

➤ **USB Devices**

Display all detected USB devices.

- **Module Configuration**

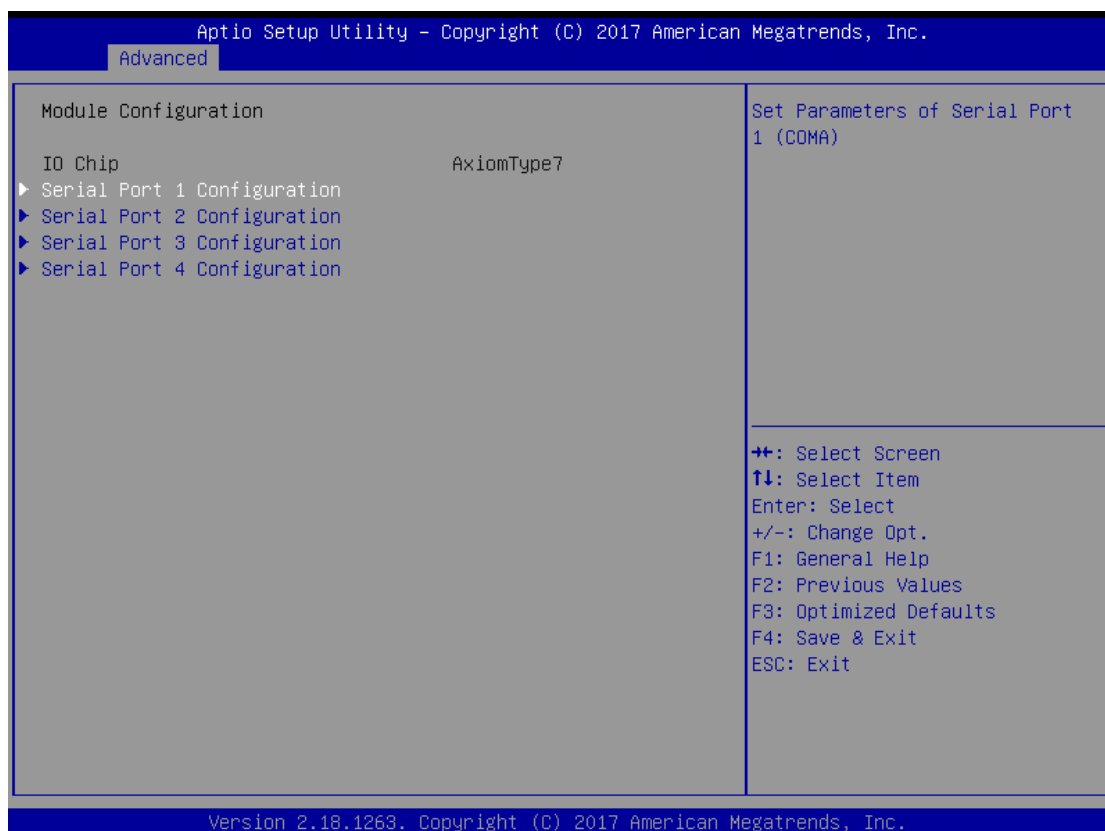

- **Serial Port 1~4 Configuration**

Use this item to set parameters of serial port 1 to 4.

- **Serial Port (1~4) Configuration**

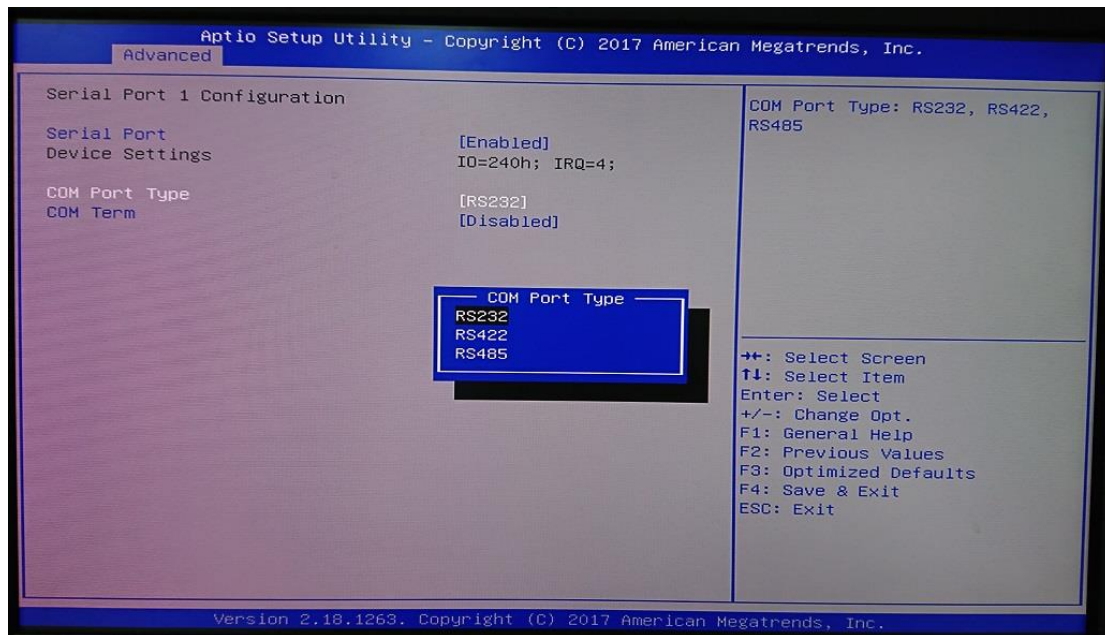

- **COM Port Type**

Use this item to set parameters of RS232/422/485.

● **CSM Configuration**

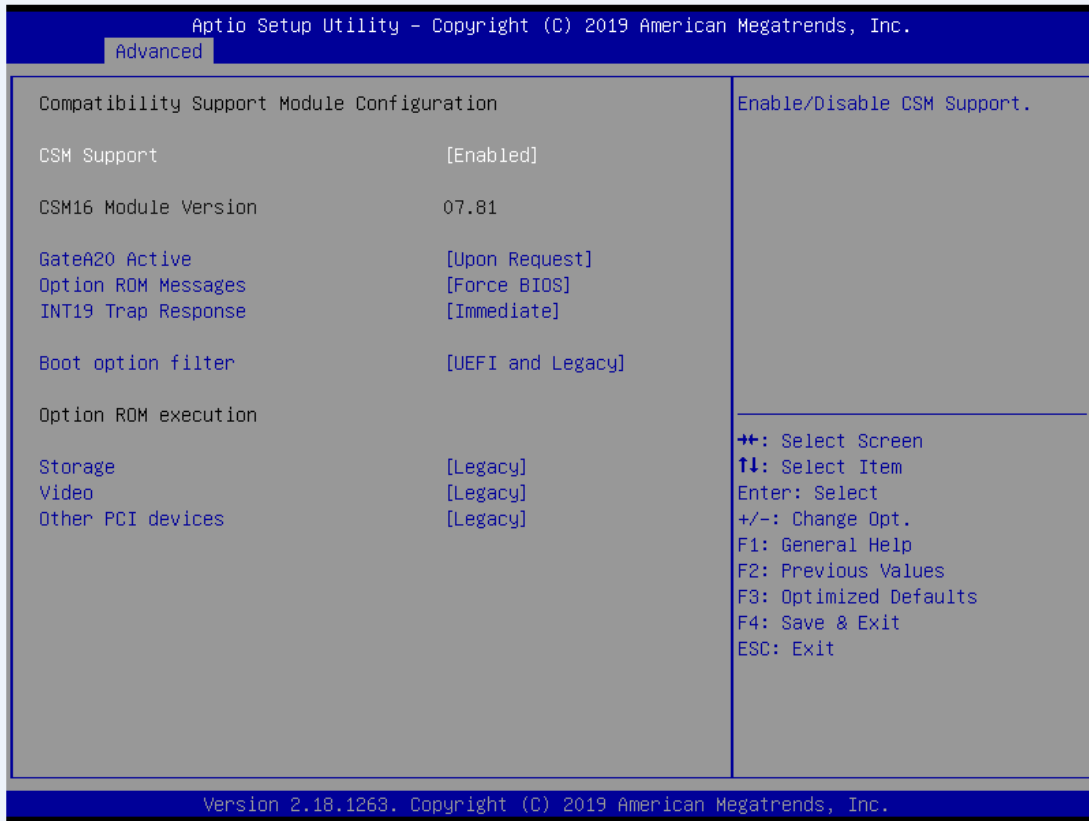

- **AMT Configuration**

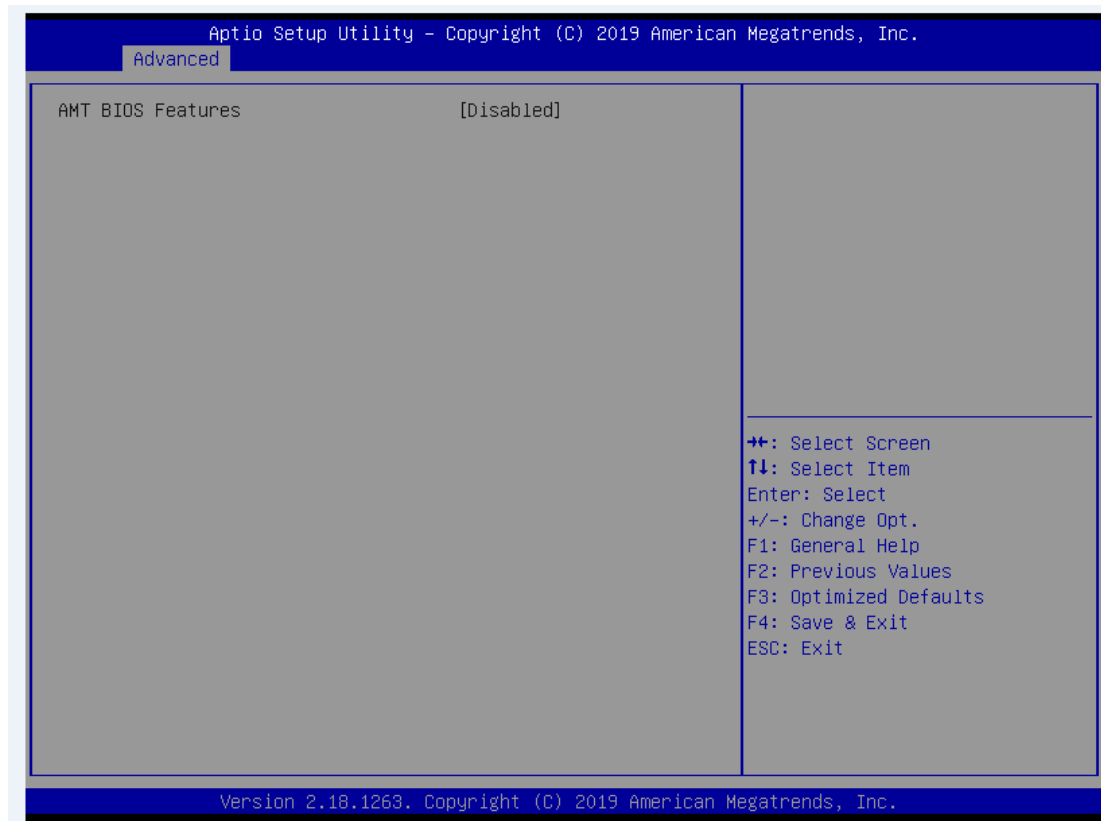

● Platform Misc Configuration

Aptio Setup Utility - Copyright (C) 2019 American Megatrends, Inc.	
Advanced	
Platform Misc Configuration	
Native PCIE Enable	[Disabled]
	Bit - PCIe Native * control 0 - ~ Hot Plug 1 - SHPC Native Hot Plug control 2 - ~ Power Management Events 3 - PCIe Advanced Error Reporting control 4 - PCIe Capability Structure control 5 - Latency Tolerance Reporting control
	++: Select Screen ↑↓: Select Item Enter: Select +/-: Change Opt. F1: General Help F2: Previous Values F3: Optimized Defaults F4: Save & Exit ESC: Exit
Version 2.18.1263. Copyright (C) 2019 American Megatrends, Inc.	

- **Utility Configuration**



3.5 Chipset Menu

The Chipset menu allows users to change the advanced chipset settings. You can select any of the items in the left frame of the screen to go to the sub menus:

► System Agent (SA) Configuration

This screen shows System Agent information and provides functions for specifying related parameters. For items marked with “►”, please press <Enter> for more options.

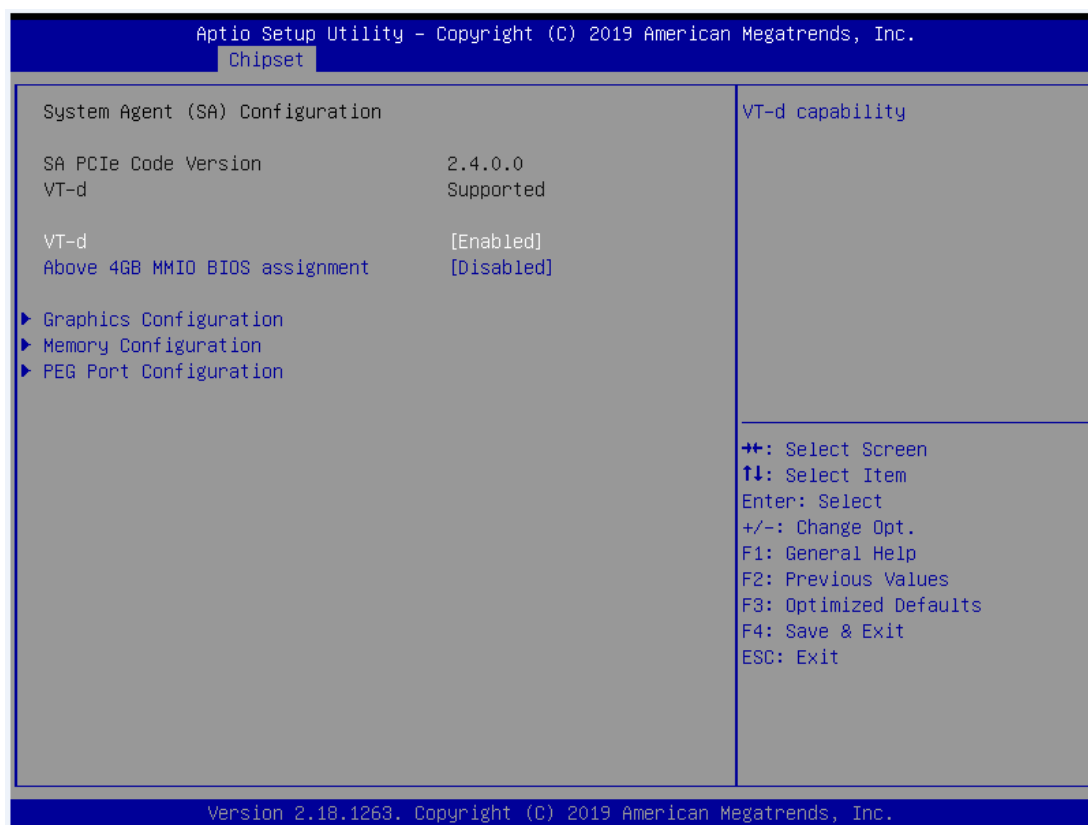

➤ Graphics Configuration

Use this item for graphics configuration settings.

➤ Memory Configuration

Use this item for memory configuration settings.

- **Graphics Configuration**

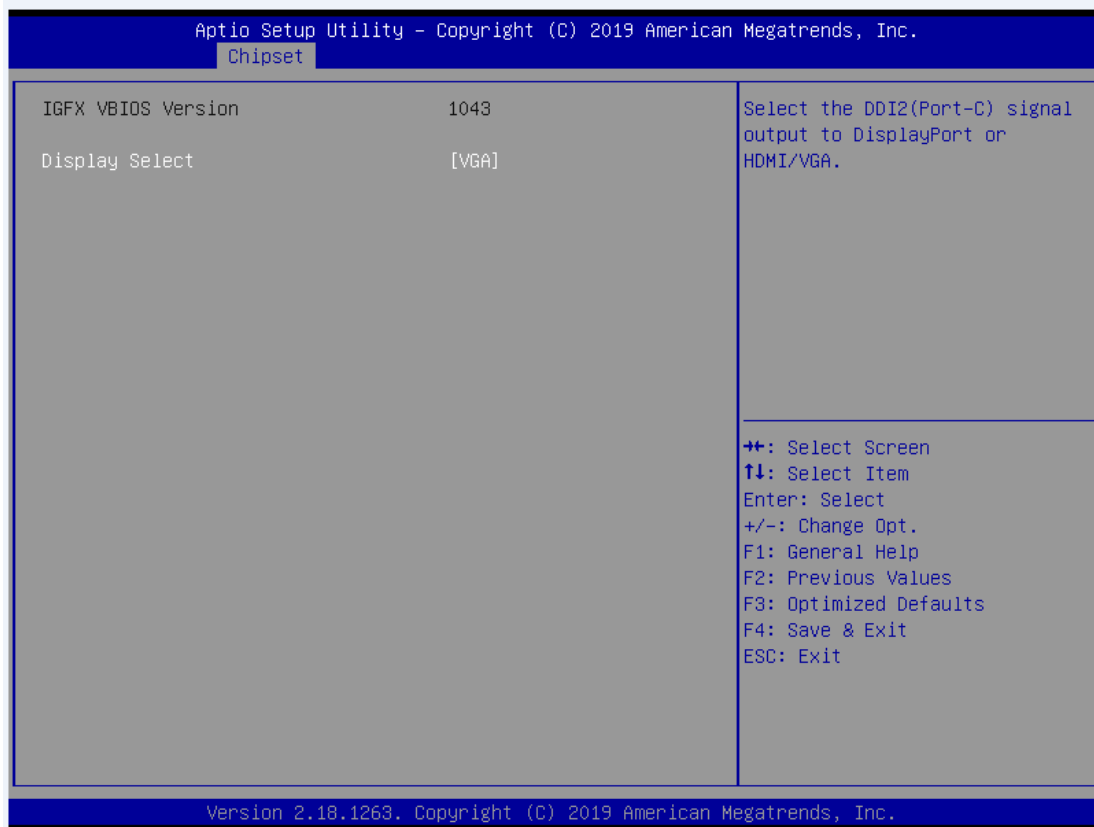

- **Display Select**

Allows you to select which graphics controller to use as the primary boot device.

- **Memory Configuration**

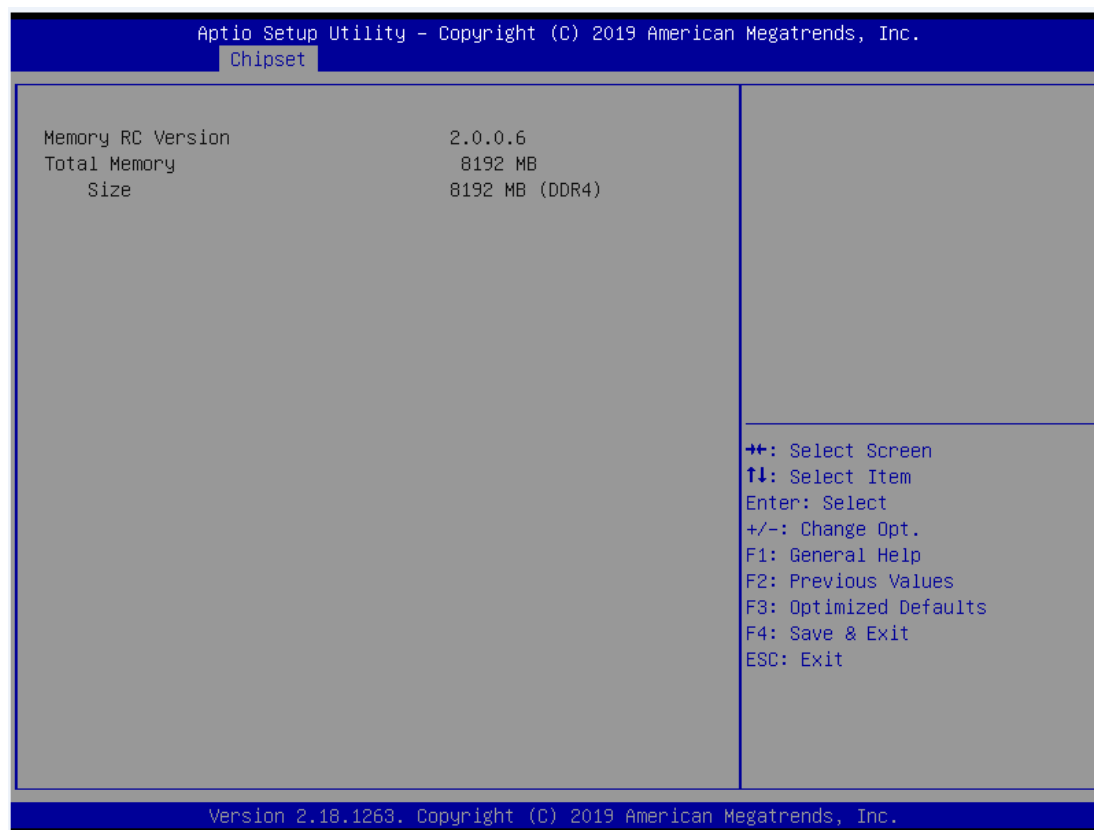

- **PEG Port Configuration**

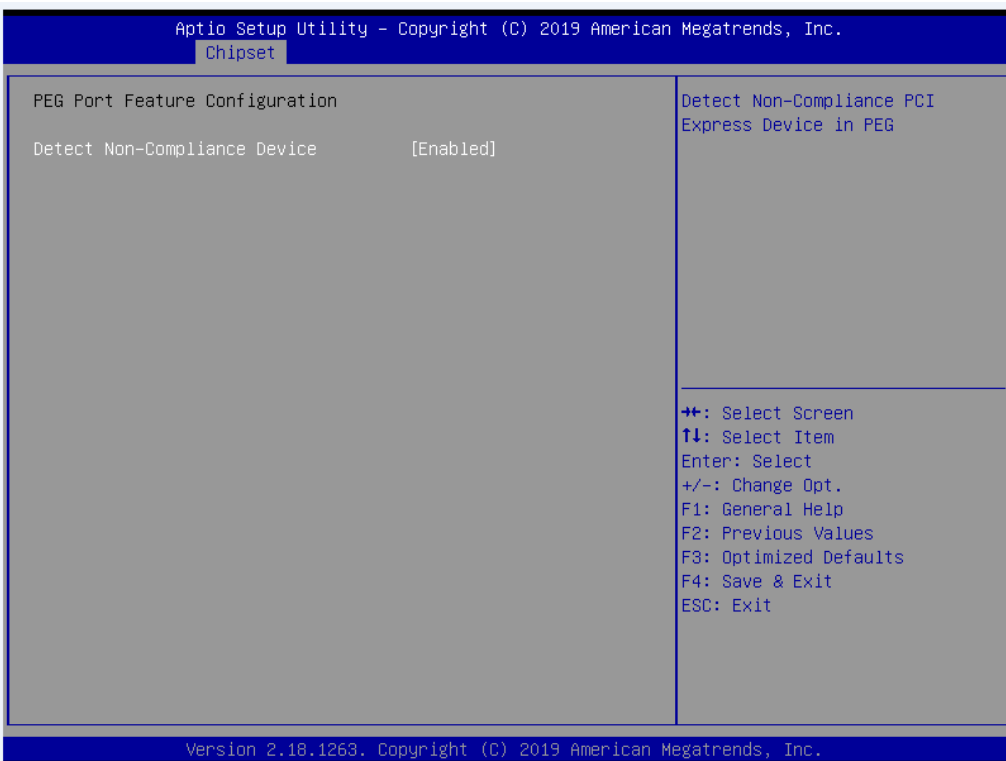
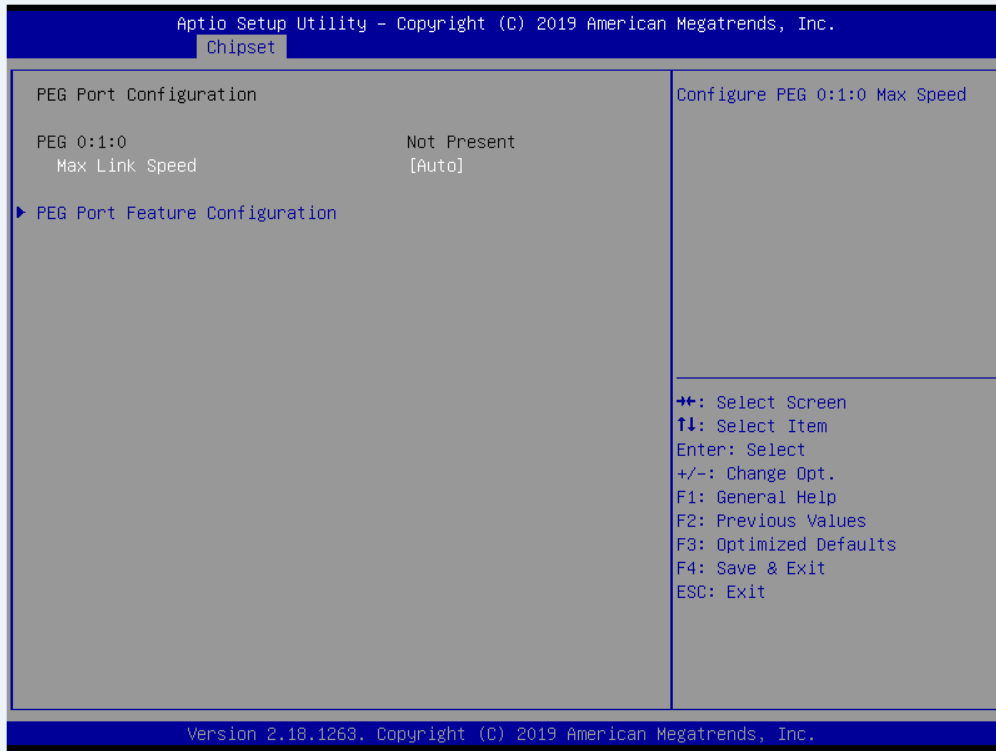

- **PEG Port Feature Configuration**

Use this item for PEG Port configuration setting.

► PCH-IO Configuration

For items marked with “►”, please press <Enter> for more options.

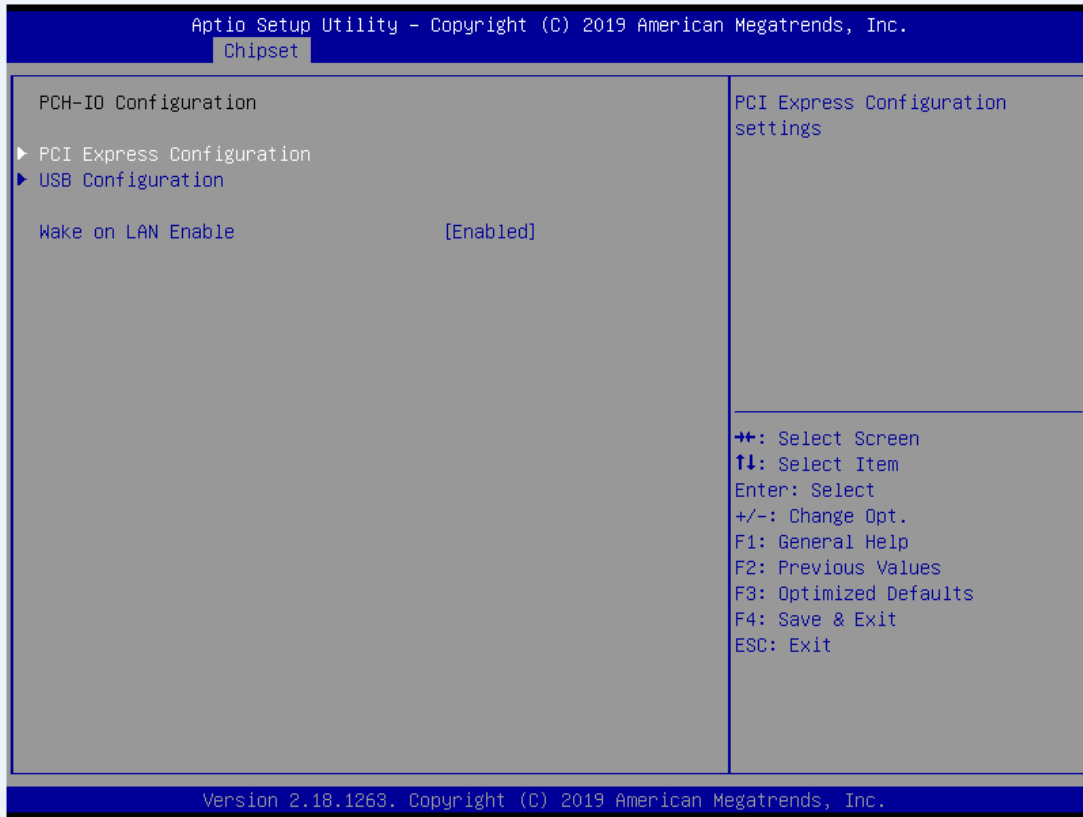

● **PCI Express Configuration**

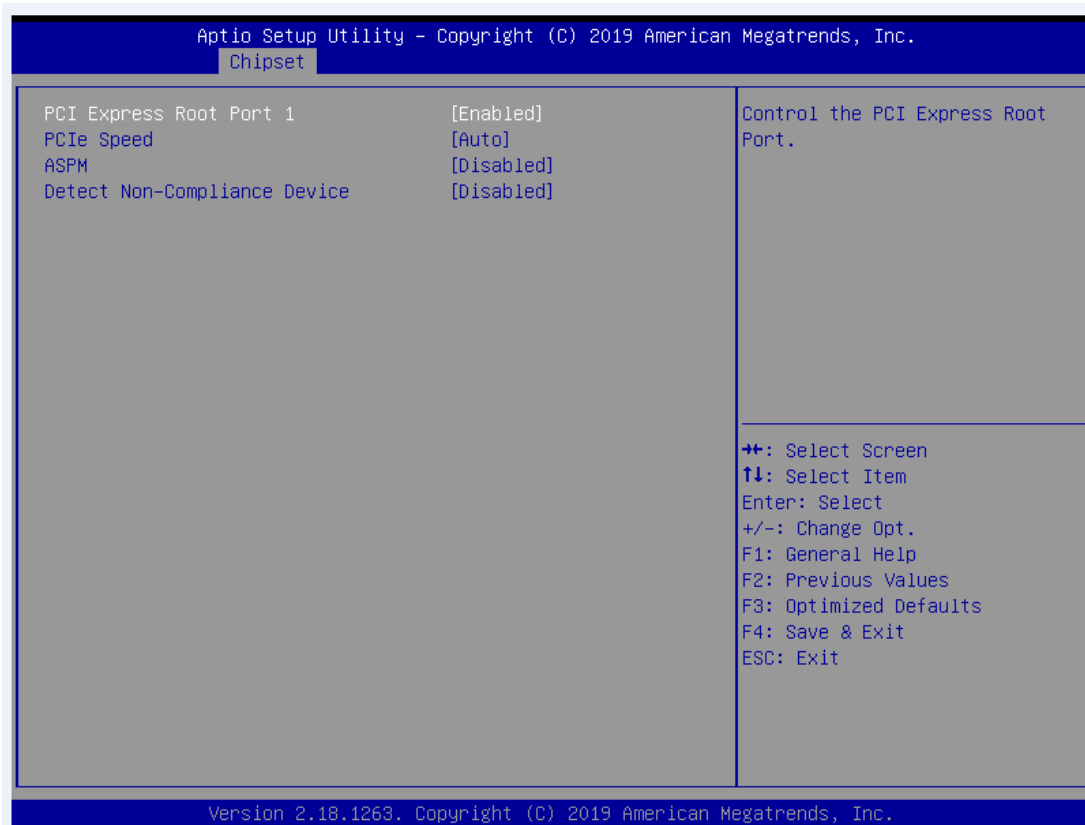

- **USB Configuration**

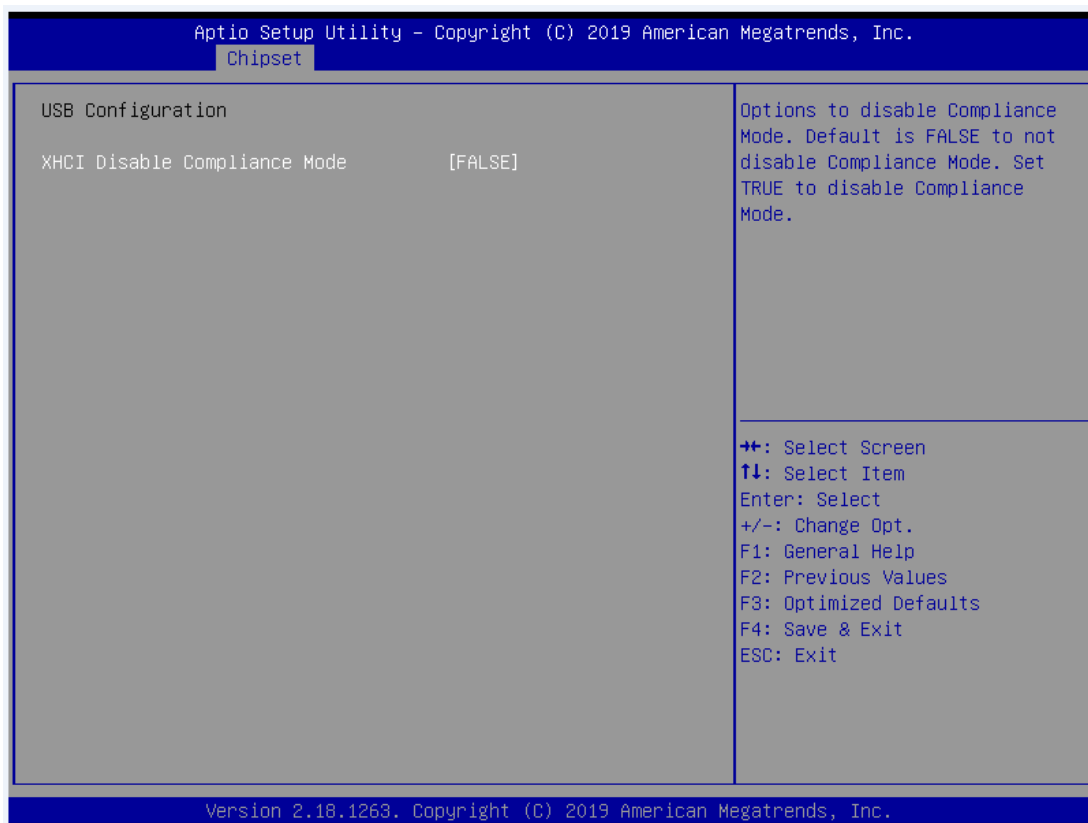

3.6 Security Menu

The Security menu allows users to change the security settings for the system.

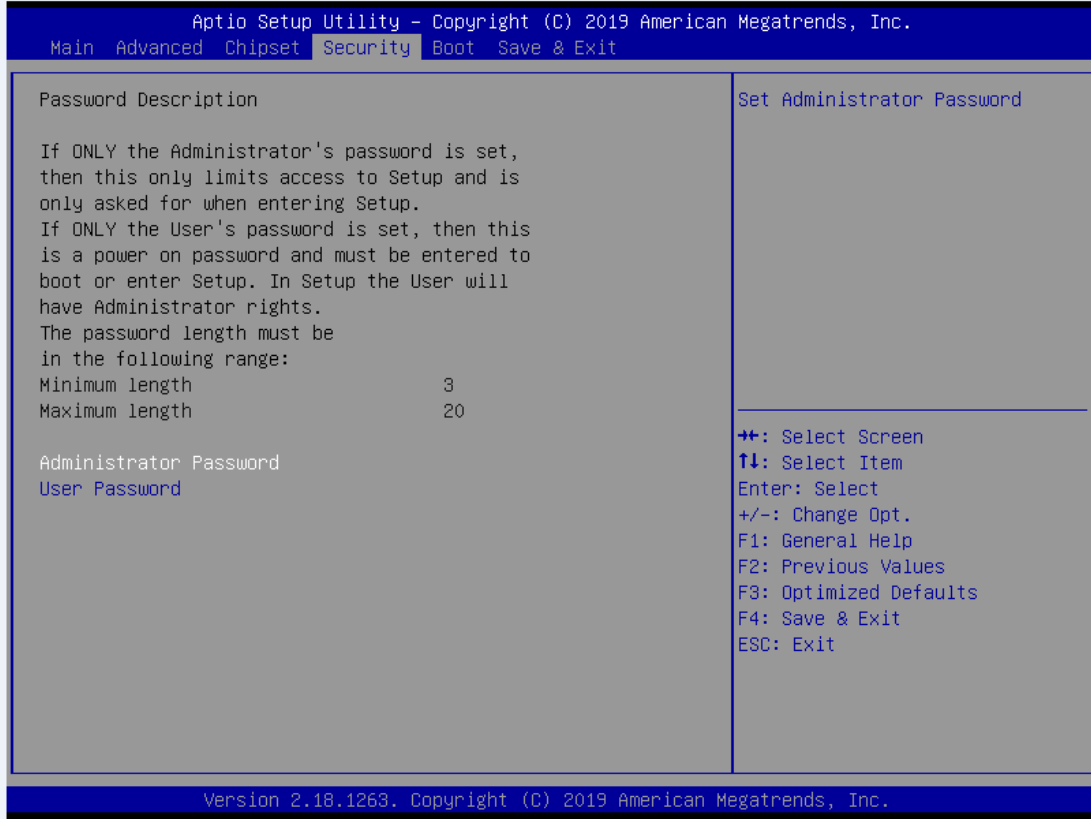

➤ **Administrator Password**

This item indicates whether an administrator password has been set (installed or uninstalled).

➤ **User Password**

This item indicates whether an user password has been set (installed or uninstalled).

3.7 Boot Menu

The Boot menu allows users to change boot options of the system.

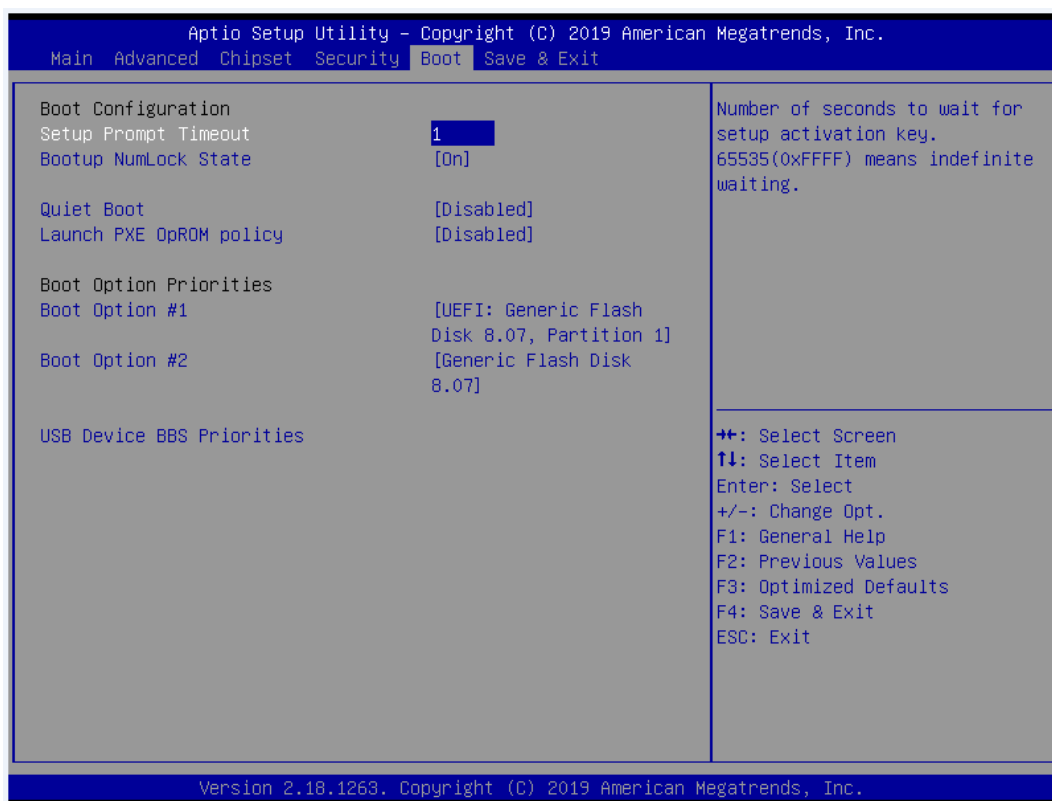

- **Setup Prompt Timeout**
Set the number of seconds to wait for setup activation key. 65535(0xFFFF) means indefinite waiting.
- **Bootup NumLock State**
Use this item to select the power-on state for the keyboard NumLock.
- **Quiet Boot**
Select to display either POST output messages or a splash screen during boot-up.
- **Launch PXE OpROM policy**
Use this item to enable or disable the boot ROM function of the onboard LAN chip when the system boots up.
- **Boot Option Priorities**
These are settings for boot priority. Specify the boot device priority sequence from the available devices.

3.8 Save & Exit Menu

The Save & Exit menu allows users to load your system configuration with optimal or fail-safe default values.

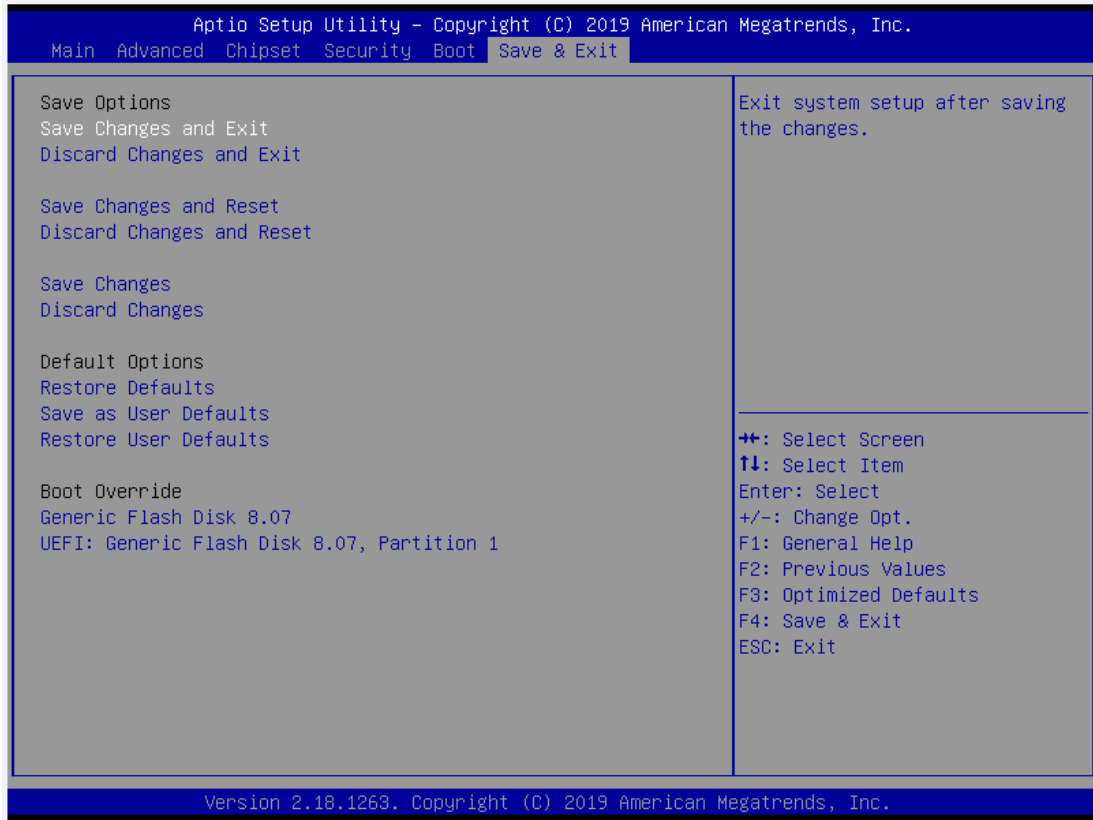

➤ **Save Changes and Exit**

When finishing the system configuration settings, select this option to leave Setup and return to Main Menu. Select Save Changes and Exit from the Save & Exit menu and press <Enter>. Select Yes to save changes and exit.

➤ **Discard Changes and Exit**

Select this option to quit Setup without making any permanent changes to the system configuration and return to Main Menu. Select Discard Changes and Exit from the Save & Exit menu and press <Enter>. Select Yes to discard changes and exit.

➤ **Save Changes and Reset**

When finishing the system configuration settings, select this option to leave Setup and reboot the computer so the new system configuration parameters can take effect. Select Save Changes and Reset from the Save & Exit menu and press <Enter>. Select Yes to save changes and reset.

➤ **Discard Changes and Reset**

Select this option to quit Setup without making any permanent changes to the system configuration and reboot the computer. Select Discard Changes and Reset from the Save & Exit menu and press <Enter>. Select Yes to discard changes and reset.

➤ **Save Changes**

When finishing the system configuration settings, select this option to save changes. Select Save Changes from the Save & Exit menu and press <Enter>. Select Yes to save changes.

➤ **Discard Changes**

Select this option to quit Setup without making any permanent changes to the system configuration. Select Discard Changes from the Save & Exit menu and press <Enter>. Select Yes to discard changes.

➤ **Restore Defaults**

After selecting this option, all the settings will be restored to defaults automatically. Select Restore Defaults from the Save & Exit menu and press <Enter>.

➤ **Save as User Defaults**

Select this option to save your current system configuration settings as User Defaults. Select Save as User Defaults from the Save & Exit menu and press <Enter>.

➤ **Restore User Defaults**

After selecting this option, all the settings will be restored to user defaults automatically. Select Restore User Defaults from the Save & Exit menu and press <Enter>.

➤ **Boot Override**

Select a drive to immediately boot that device regardless of the current boot order.

This page is intentionally left blank.

APPENDIX A

WATCHDOG TIMER

A.1 About Watchdog Timer

Software stability is major issue in most applications. Some embedded systems are not watched by an operator for 24 hours. It is usually too slow to wait for someone to reboot when computer hangs. The systems need to be able to reset automatically when things go wrong. The watchdog timer gives us solutions in this regard.

The watchdog timer is a counter that triggers a system to reset when it counts down to zero from a preset value. The software starts the counter with an initial value and must reset it periodically. If the counter ever reaches zero which means the software has crashed, the system will reboot.

A.2 How to Use Watchdog Timer

The I/O port base addresses of watchdog timer are 2E (hex) and 2F (hex). The 2E (hex) and 2F (hex) are address and data port respectively.

Assume that program A is put in a loop that must execute at least once every 10ms. Initialize watchdog timer with a value bigger than 10ms. If the software has no problems, watchdog timer will never expire because software will always restart the counter before it reaches zero.

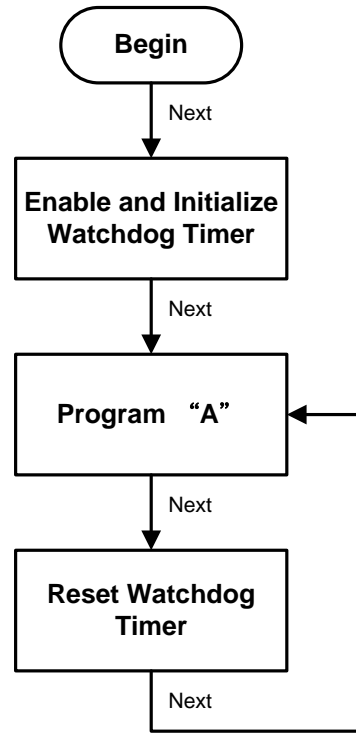
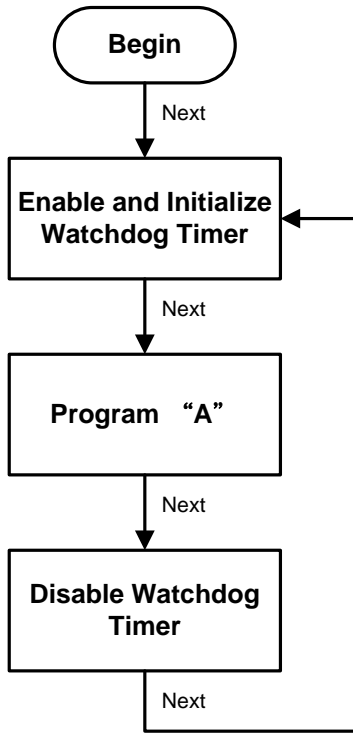

A.3 Sample Program

Assembly sample code :

;Enable WDT:

```
mov    dx,2Eh
mov    al,87          ;Un-lock super I/O
out    dx,al
out    dx,al
```

;Select Logic device:

```
mov    dx,2Eh
mov    al,07h
out    dx,al
mov    dx,2Fh
mov    al,07h
out    dx,al
```

;Enable WDT base address:

```
mov    dx,2Eh
mov    al,30h
out    dx,al
mov    dx,2Fh
mov    al,01h
out    dx,al
```

;Activate WDT:

```
mov    dx,2Eh
mov    al,0F0h
```

```
out    dx,al
mov    dx,2Fh
mov    al,80h
out    dx,al
```

;Set base timer :

```
mov    dx,2Eh
mov    al,0F6h
out    dx,al
mov    dx,2Fh
mov    al,Mh          ;M=00h,01h,...FFh (hex),Value=0 to 255
out    dx,al        ;(see  Note below)
```

;Set Second or Minute :

```
mov    dx,2Eh
mov    al,0F5h
out    dx,al
mov    dx,2Fh
mov    al,Nh          ;N=71h or 79h(see  Note below)
out    dx,al
```

 **Note:**

If **N=71h**, the time base is set to second.

M = time value

00: Time-out disable

01: Time-out occurs after 1 second

02: Time-out occurs after 2 seconds

03: Time-out occurs after 3 seconds

FFh: Time-out occurs after 255 seconds

If N=79h, the time base is set to minute.

M = time value

00: Time-out disable

01: Time-out occurs after 1 minute

02: Time-out occurs after 2 minutes

03: Time-out occurs after 3 minutes

.

.

FFh: Time-out occurs after 255 minutes

This page is intentionally left blank.

APPENDIX B

HDD HOT-SWAPPABLE

The IPC974-519 offers up to four hot-swappable 2.5" HDD or SSD; users can easy install and replace the storages by following the steps below.

Using HDD hot-swappable function

Step 1 Press "Delete" after turning on the system, then following the path to enable the Hot Plug function:

BIOS setup → Advanced → SATA Controller(s) → SATA Mode Selection →
Serial ATA Port → Hot Plug enable

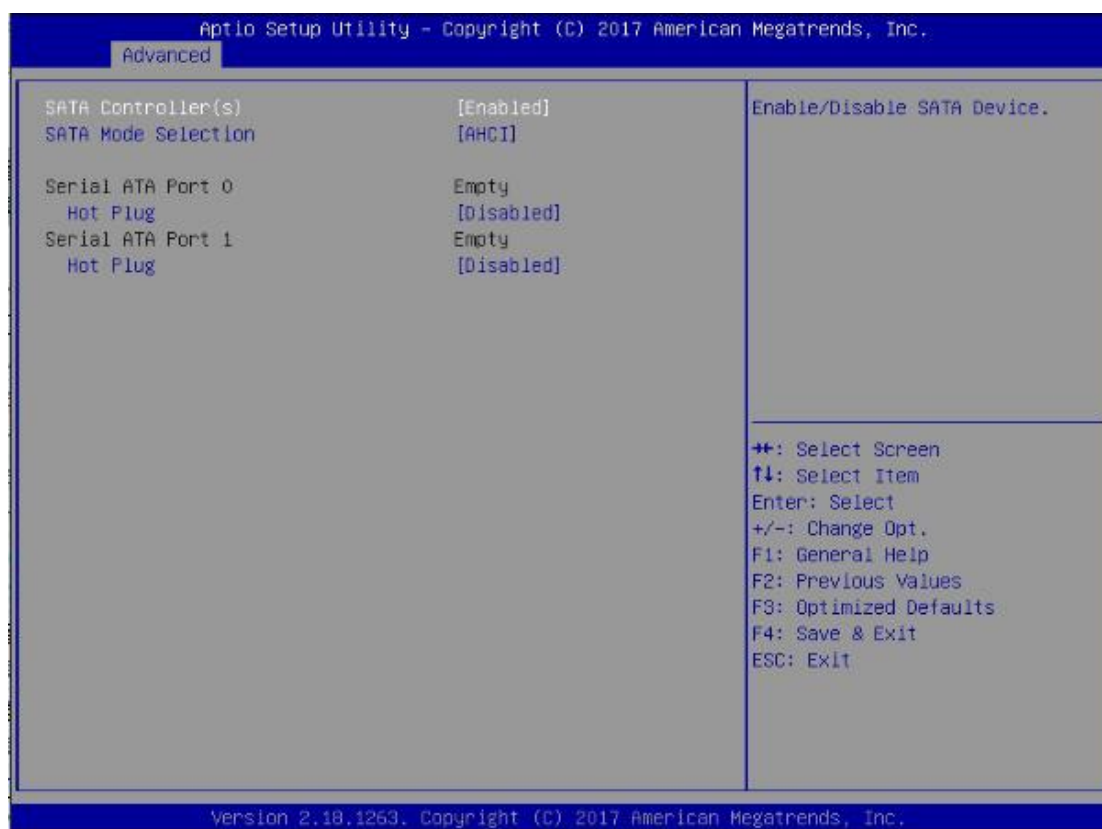

Step 2 System auto reboots; installation is complete.

Removing Hot-Swappable storage

Step 1 Click “”

Step 2 Select “Eject xxxx”.

Step 3 Remove the HDD device after “Safe To Remove Hardware” is shown.

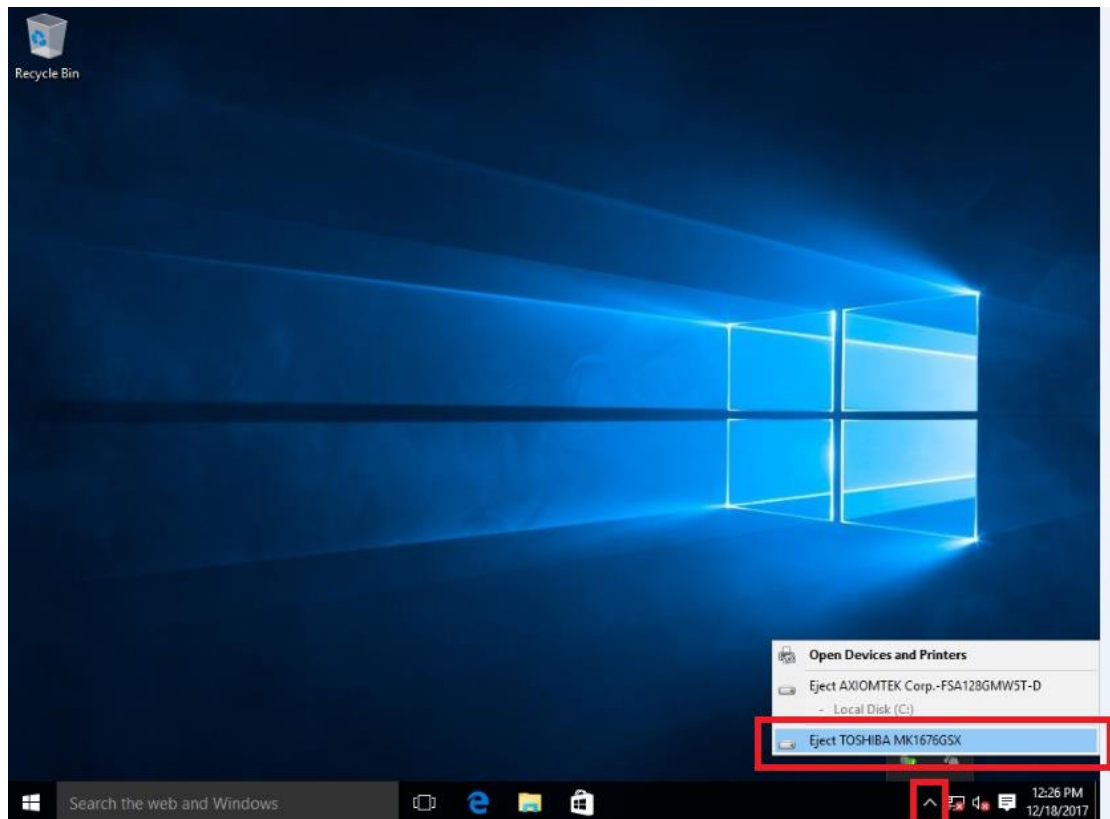

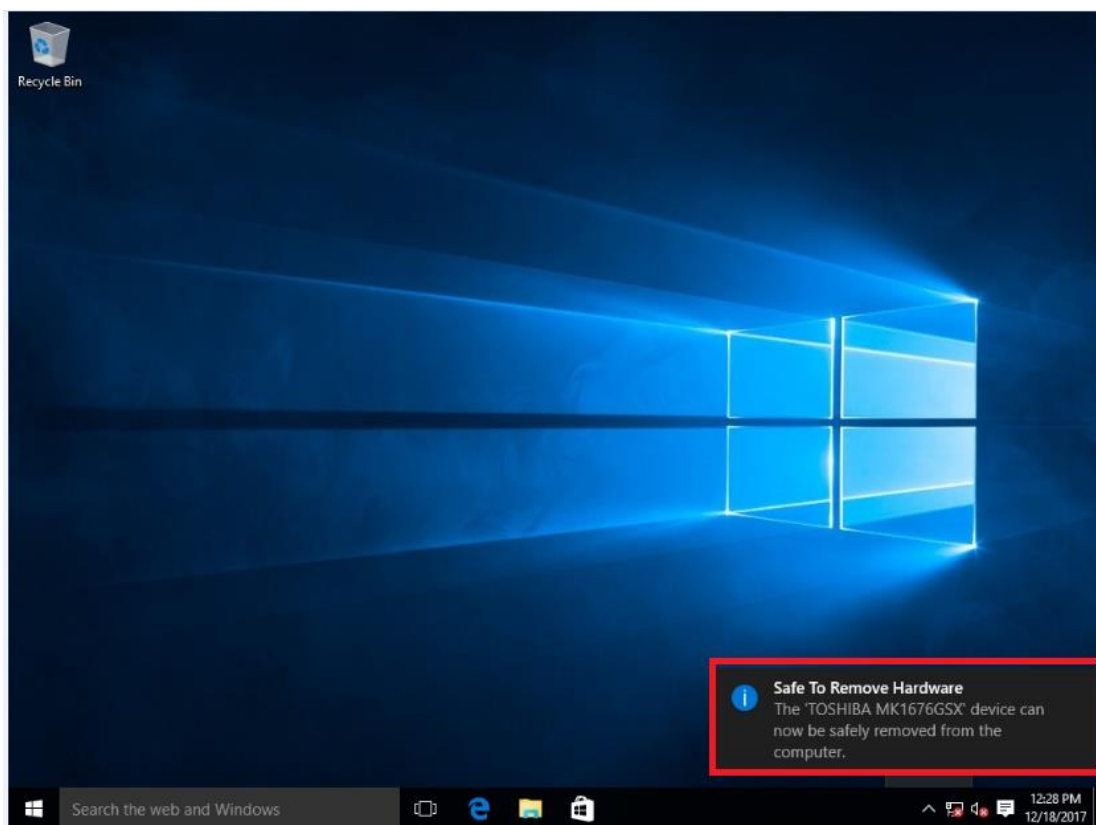

Note: Please close all programs which are currently using the device before removing the device.

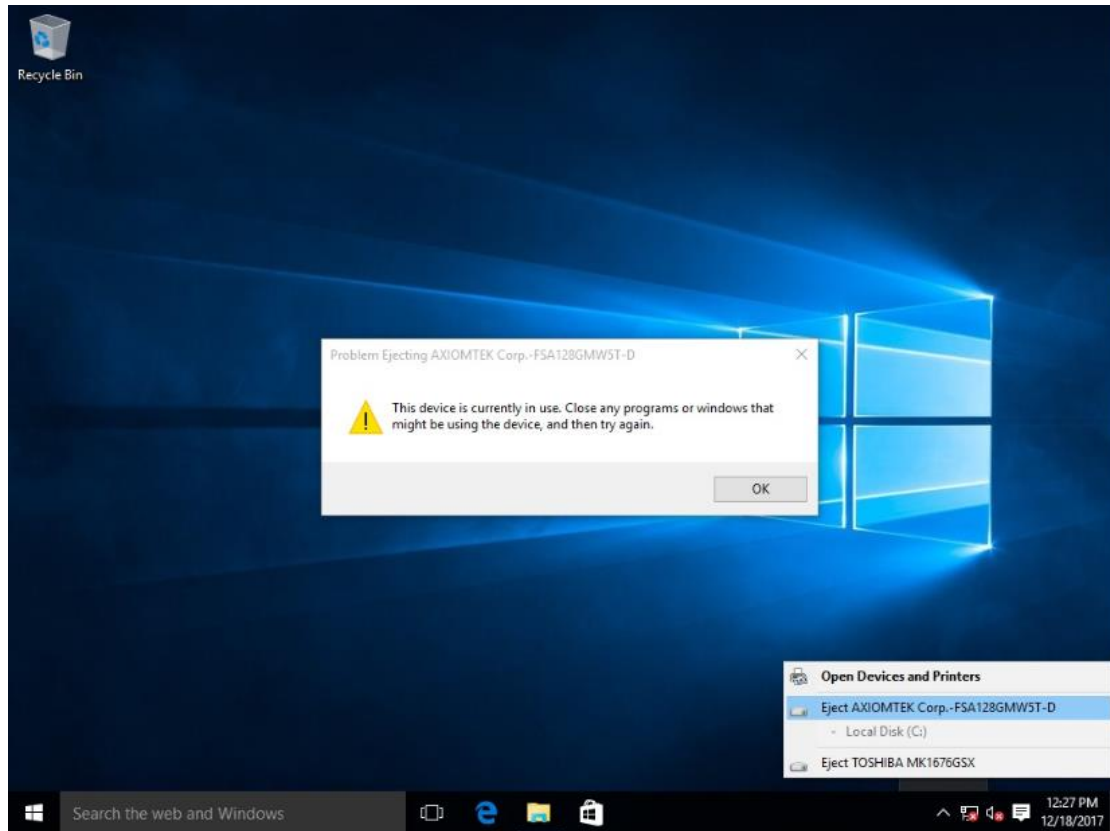

APPENDIX C

CONFIGURING SATA FOR RAID

Configuring SATA Hard Drive(s) for RAID (Controller: Intel® C236)

Before you begin the SATA configuration, please prepare four SATA hard drives (to ensure optimal performance, it is recommended that you use two hard drives with the identical model and capacity). If you do not want to create RAID with the SATA controller, you may prepare only one hard drive.

Please follow the steps below to configure SATA hard drive(s):

1. Install SATA hard drive(s) in your system.
2. Enter the BIOS Setup to configure SATA controller mode and boot sequence.
3. Configure RAID using the RAID BIOS.

1. Installing SATA hard drive(s) in your system.

Connect one end of the SATA signal cable to the rear of the SATA hard drive, and the other end to an available SATA port on the board. Then, connect the power connector of power supply to the hard drive.

2. Configuring SATA controller mode and boot sequence by the BIOS Setup.

You have to make sure whether the SATA controller is configured correctly by system BIOS Setup and set up BIOS boot sequence for the SATA hard drive(s).

- 2.1. Turn on your system, and then press the button to enter BIOS Setup during running POST (Power-On Self-Test). If you want to create RAID, just go to the Advanced Settings menu\SATA Configuration, select the "SATA Mode Selection", and press <Enter> for more options.

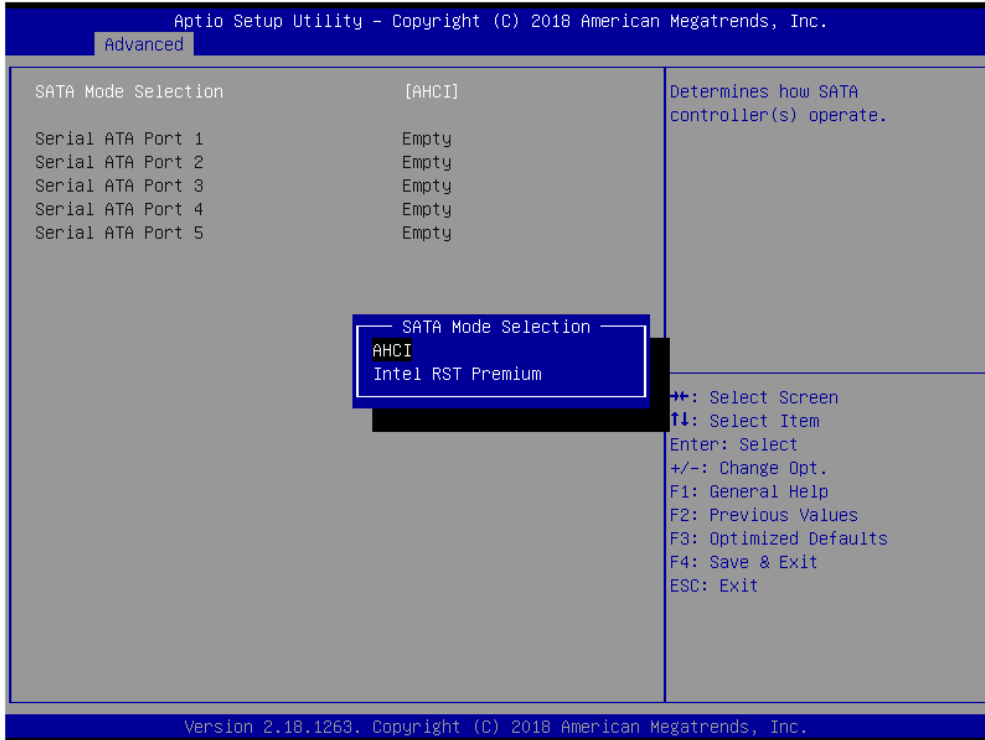

A list of options appears. Please select "Intel RST Premium".

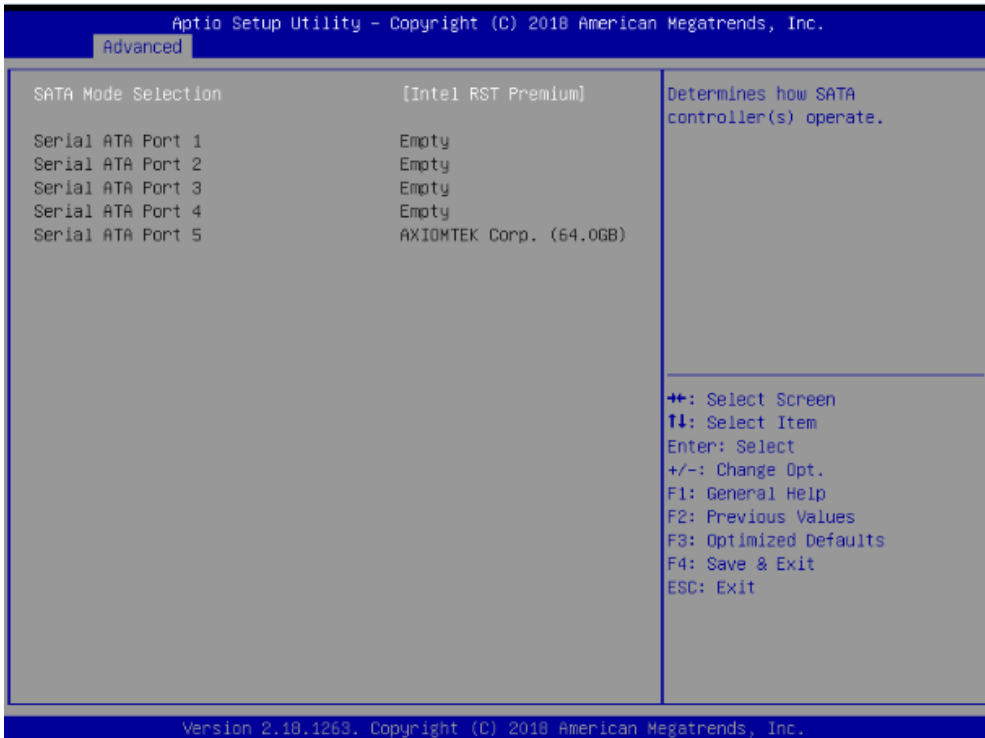

2.2. Save and exit the BIOS Setup.

3. Configuring RAID by the RAID BIOS.

Enter the RAID BIOS setup utility to configure a RAID array. Skip this step and proceed if you do not want to create a RAID.

- 3.1. After the POST memory testing and before the operating system booting, a message "Press <Ctrl-I> to enter Configuration Utility" shows up. Press <Ctrl + I> to enter the RAID BIOS setup utility.

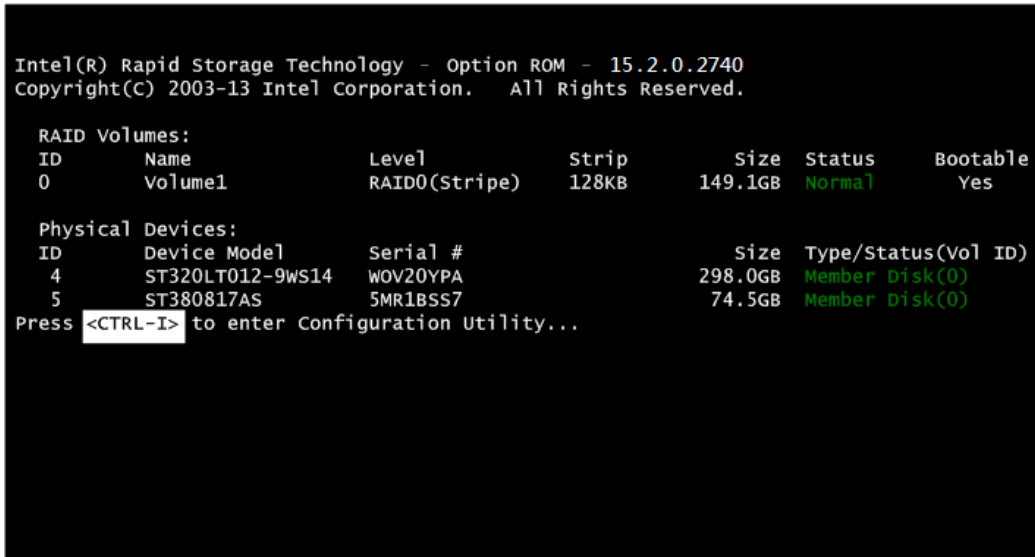

- 3.2. After you press <Ctrl + I>, the Create RAID Volume screen will appear. If you want to create a RAID array, select the Create RAID Volume option in the Main Menu and press <Enter>.

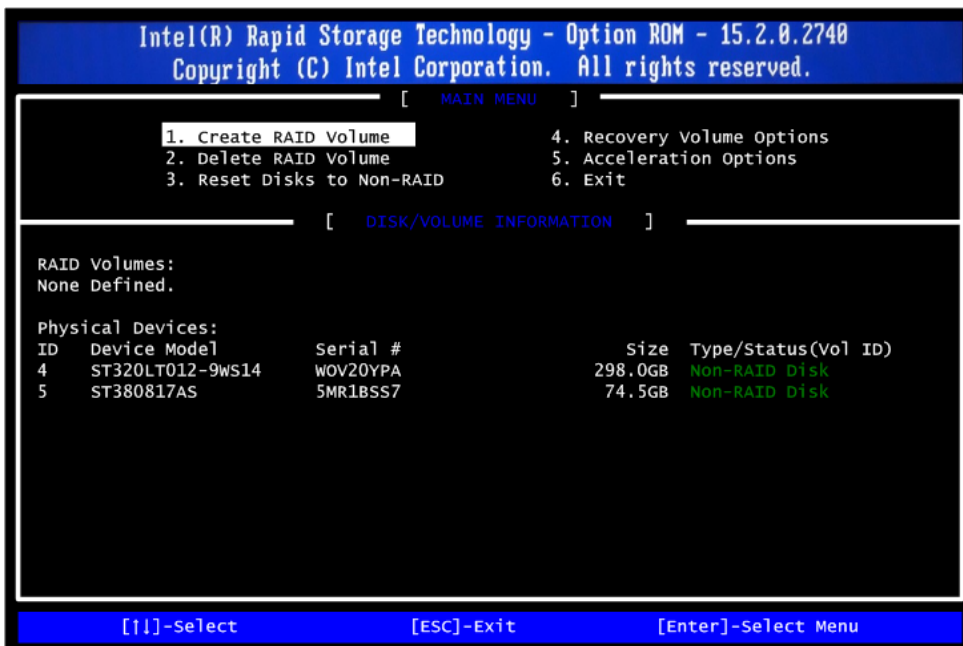

- 3.3. After entering the Create Volume Menu screen, you can type the disk array name with 1~16 letters (letters cannot be special characters) in the item "Name:".

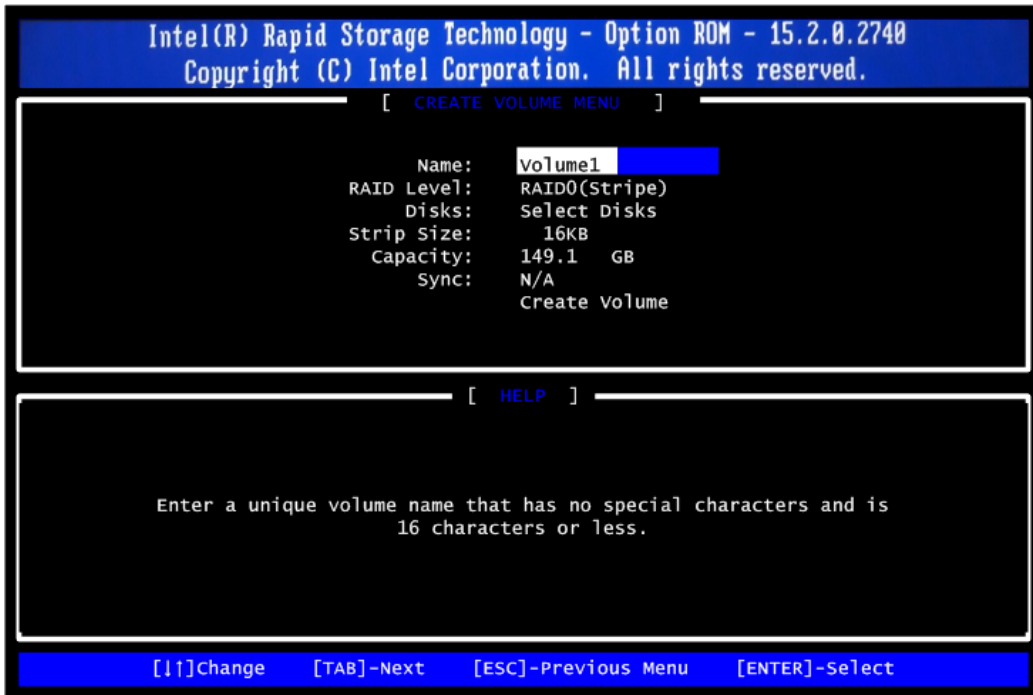

- 3.4. When finished, press <Enter> to select a RAID level. There are two RAID levels: RAID0, RAID1. Select a RAID level and press <Enter>.



- 3.5. Set the stripe block size. The KB is the standard unit of stripe block size. The stripe block size can be 4KB to 128KB. After the setting, press <Enter> for the array capacity.

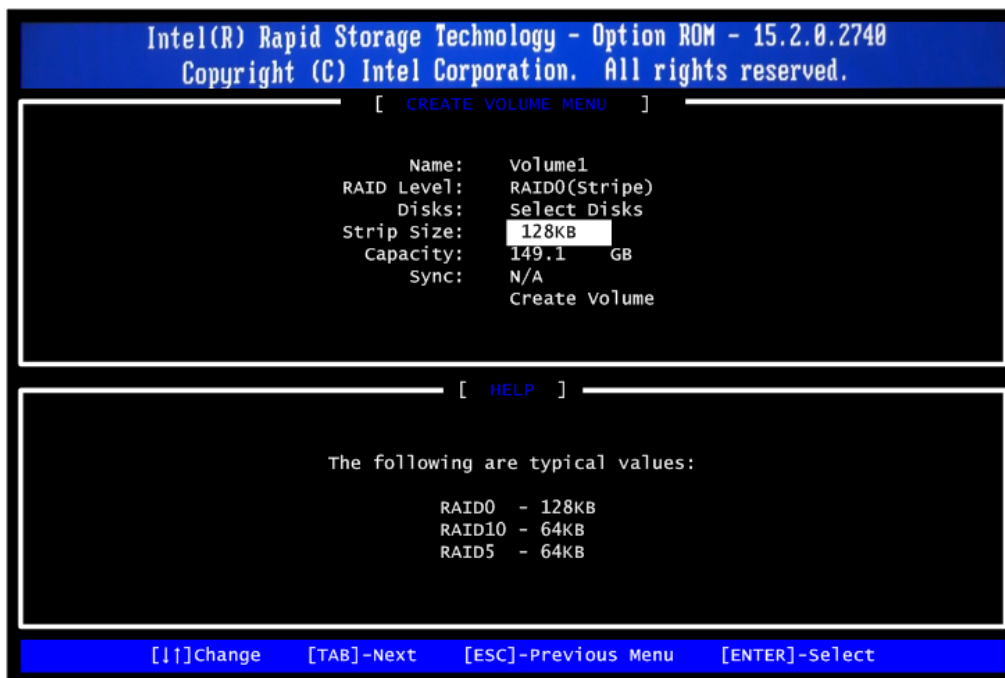

- 3.6. After setting all the items on the menu, select Create Volume and press <Enter> to start creating the RAID array.

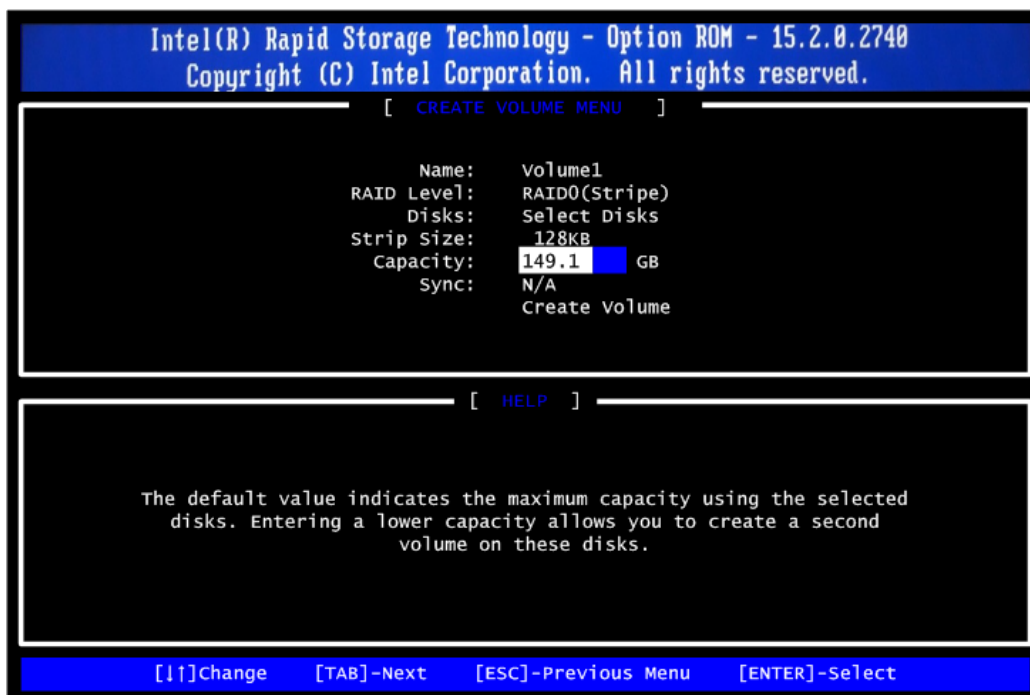

When prompting the confirmation, press <Y> to create this volume, or <N> to cancel the creation.

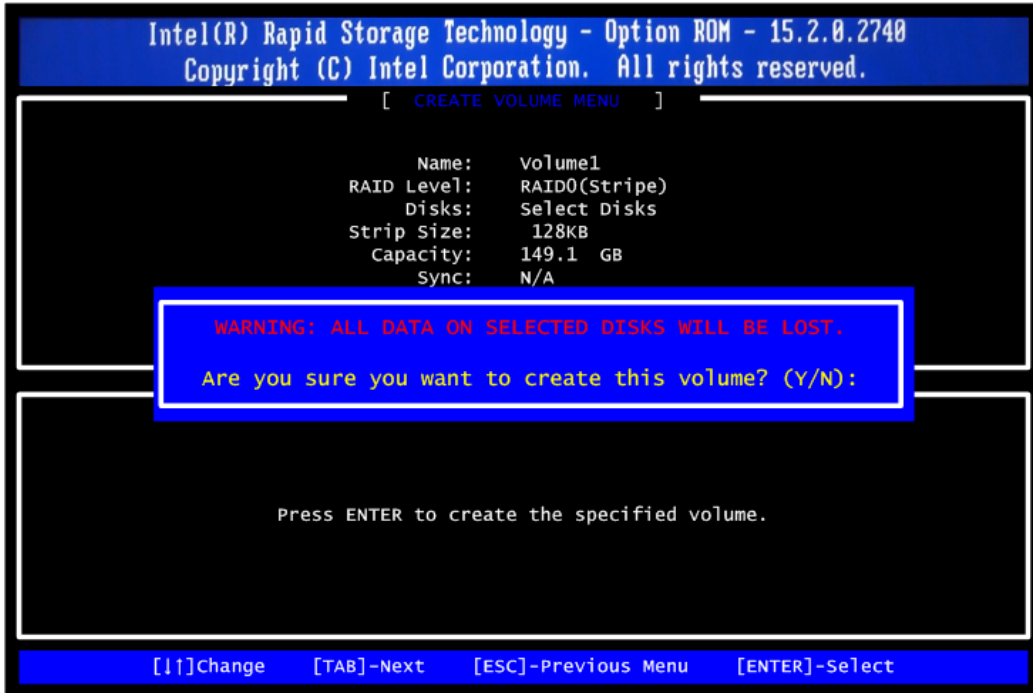

After the creation is completed, you will see detailed information about the RAID array in the Disk/Volume Information section, including RAID mode, disk block size, disk name, disk capacity, etc.

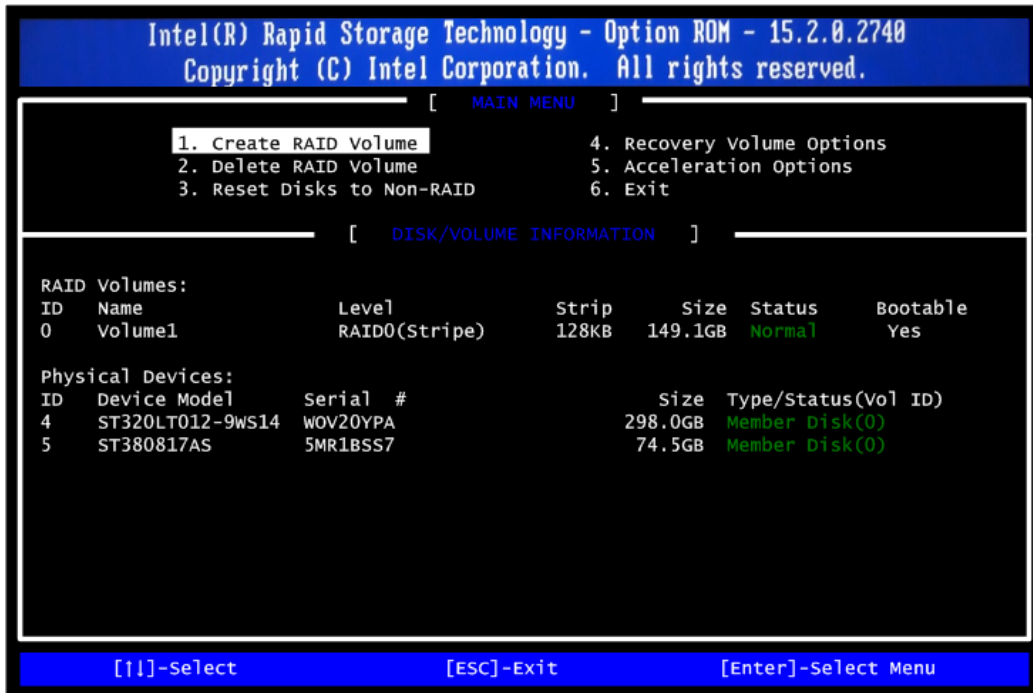

Delete RAID volume

If you want to delete a RAID volume, select the Delete RAID Volume option in Main Menu. Press <Enter> and follow on-screen instructions.

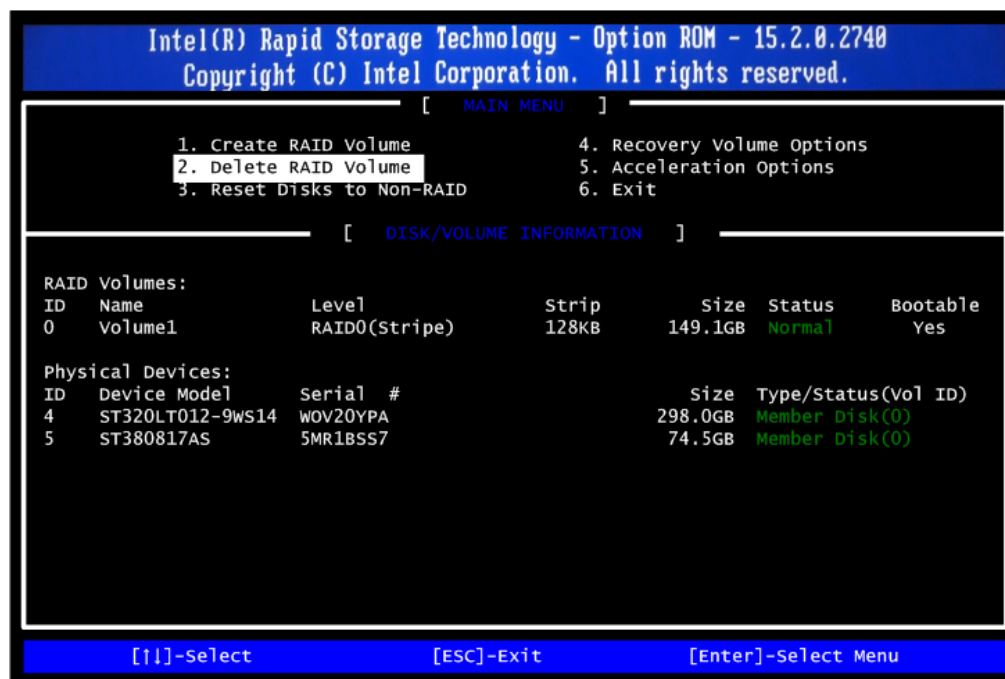

Please press <Esc> to exit the RAID BIOS utility. Now, you can proceed to install a SATA driver controller and the operating system.