

# USER'S MANUAL

## **IMB523R / 524R / 525R**

Intel® Socket 1151 Core™ i7/ i5/ i3 /  
Pentium® / Celeron®  
Processors ATX Industrial  
Motherboard

**User's Manual**



[www.axiomtek.com](http://www.axiomtek.com)

## **Disclaimers**

This manual has been carefully checked and believed to contain accurate information. Axiomtek Co., Ltd. assumes no responsibility for any infringements of patents or any third party's rights, and any liability arising from such use.

Axiomtek does not warrant or assume any legal liability or responsibility for the accuracy, completeness or usefulness of any information in this document. Axiomtek does not make any commitment to update the information in this manual.

Axiomtek reserves the right to change or revise this document and/or product at any time without notice.

No part of this document may be reproduced, stored in a retrieval system, or transmitted, in any form or by any means, electronic, mechanical, photocopying, recording, or otherwise, without the prior written permission of Axiomtek Co., Ltd.

## **CAUTION**

Wrong type of batteries may cause explosion. It is recommended that users only replace with the same or equivalent type of batteries as suggested by the manufacturer once properly disposing of any used ones.

**©Copyright 2020 Axiomtek Co., Ltd.**

**All Rights Reserved**

**July 2020, Version A2**

**Printed in Taiwan**

## ESD Precautions

Computer boards have integrated circuits sensitive to static electricity. To prevent chipsets from electrostatic discharge damage, please take care of the following jobs with precautions:

- Do not remove boards or integrated circuits from their anti-static packaging until you are ready to install them.
- Before holding the board or integrated circuit, touch an unpainted portion of the system unit chassis for a few seconds. To discharge static electricity from your body.
- Wear a grounding wrist strap, available from most electronic component stores, when handling boards and components.

## Trademarks Acknowledgments

Axiomtek is a trademark of Axiomtek Co., Ltd.

Intel<sup>®</sup> and Celeron<sup>®</sup> are trademarks of Intel Corporation.

Windows<sup>®</sup> is a trademark of Microsoft Corporation.

AMI is a trademark of American Megatrend Inc.

IBM, PC/AT, PS/2, and VGA are trademarks of International Business Machines Corporation.

Other brand names and trademarks are the properties and registered brands of their respective owners.

# Table of Contents

---

Disclaimers .....	ii
ESD Precautions.....	iii
<b>Chapter 1 Introduction.....</b>	<b>1</b>
1.1 Features.....	2
1.2 Specifications.....	2
1.3 Packing list .....	4
<b>Chapter 2 Board and Pin Assignments.....</b>	<b>5</b>
2.1 Board Layout.....	5
2.2 Rear I/O.....	7
2.3 Block Diagram.....	8
2.4 Jumper Settings .....	10
2.4.1 Clear CMOS (JP8) .....	11
2.4.2 AT/ATX Mode Select (JP9).....	11
2.4.3 COM1 Mode Select (JP4, JP5, JP6).....	12
2.4.4 COM2 Mode Select (JP1, JP2, JP3).....	12
2.4.5 Temperature Sensor Source Select .....	12
2.4.6 PCIe x16 slot bifurcation(CN14).....	13
2.5 Connectors.....	14
2.5.1 Keyboard and PS/2 Mouse Connector (CN1).....	15
2.5.2 DisplayPort++ and HDMI Connector (CN2) .....	15
2.5.3 VGA and DVI-D Connector (CN3).....	16
2.5.4 Audio Jack (CN4) .....	16
2.5.5 LAN and USB 3.1 Connectors (CN5 and CN6) .....	17
2.5.6 Internal Keyboard Connector (CN8).....	17
2.5.7 Internal Mouse Connector (CN9) .....	18
2.5.8 Front Audio Header (CN11).....	18
2.5.9 PCI-Express x4 Slots (CN12 and CN13) .....	19
2.5.10 PCIe x16 slot (CN14) .....	20
2.5.11 External Sensor Header (CN15).....	20
2.5.12 Internal USB Headers (CN16~CN17, CN20, USB1) .....	20
2.5.13 SIM Card Slots (CN19) .....	21
2.5.14 Internal USB 3.1 Gen1 Connector (CN21).....	21
2.5.15 Mini PCI-Express Connector (CN22) .....	22
2.5.16 TPM Pin Header (CN23) .....	22
2.5.17 Front Panel Header (CN24) .....	23
2.5.18 GPIO Header (CN25).....	23
2.5.19 Power Input Connectors (ATX1 and CN26) .....	24
2.5.20 Voltage Monitor Header (CN27).....	24

2.5.21	SMBus Header (CN28) .....	25
2.5.22	COM1 Connector (COM1) .....	25
2.5.23	COM Headers (COM2 ~ COM6) .....	25
2.5.24	Fan Connectors (FAN1~FAN3) .....	26
2.5.25	SATA 3.0 Connectors (SATA1 ~ SATA6) .....	26
2.5.26	DIMM Sockets (DIMM1 ~ DIMM4) .....	27
<b>Chapter 3 Hardware Description .....</b>		<b>29</b>
3.1	Microprocessors .....	29
3.2	BIOS .....	29
3.3	System Memory .....	29
<b>Chapter 4 AMI BIOS Setup Utility .....</b>		<b>31</b>
4.1	Starting .....	31
4.2	Navigation Keys .....	31
4.3	Main Menu .....	33
4.4	Advanced Menu .....	34
4.5	Chipset Menu .....	47
4.6	Security Menu .....	56
4.7	Boot Menu .....	57
4.8	Save & Exit Menu .....	58
<b>Appendix A Watchdog Timer .....</b>		<b>61</b>
	About Watchdog Timer .....	61
	How to Use Watchdog Timer .....	61
<b>Appendix B TPM Module Installation .....</b>		<b>63</b>
<b>Appendix C iAMT Settings .....</b>		<b>67</b>
	Entering Management Engine BIOS Extension (MEBx) .....	67
	Set and Change Password .....	67
	iAMT Settings .....	69
	iAMT Web Console .....	72
<b>Appendix D Configuring SATA for RAID .....</b>		<b>75</b>
	Configuring SATA Hard Drive(s) for RAID Function .....	75
<b>Appendix E Digital I/O .....</b>		<b>83</b>
	Digital I/O Software Programming .....	83

**This page is intentionally left blank.**

# Chapter 1

## Introduction

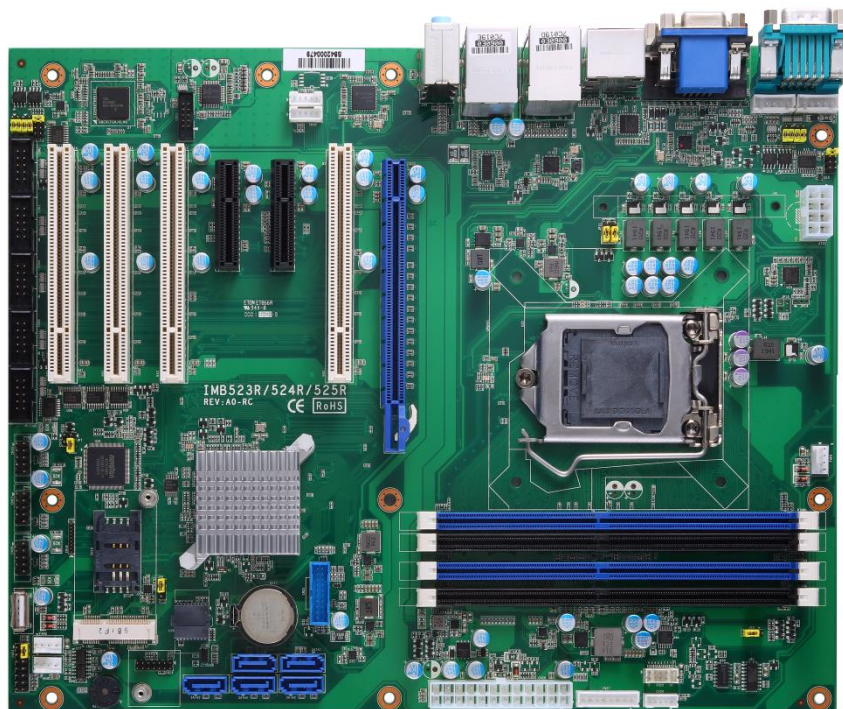

The IMB523R / 524R / 525R is an advanced ATX industrial motherboard based on the 9th/8th Generation Intel® Core™ i7/ i5/ i3/ Pentium® and Celeron® processors (Coffeelake) in an LGA1151 socket and comes with an Intel® Q370 / H310 / C246 chipset. Specially designed for optimal computing and visual performance, the IMB523R / 524R / 525R motherboard is an ideal solution for major industry applications ranging from financial modeling to designing complex buildings and vehicles. With its built-in Intel® HD Graphics GFX, this industrial grade motherboard delivers superb 3D visual performance and supports triple display through DVI-D, HDMI and VGA ports to meet professional-grade CAD and media/entertainment needs.

In addition, the IMB523R / 524R / 525R supports Intel® Turbo Boost 2.0 technology, Intel® Hyper-Threading technology, Intel® HD Graphics with DX11, 128GB DDR4 2400/2666MHz memory (Q370 / C246), 64 GB DDR4 2400/2666MHz memory (H310), and a PCI-Express 3.0 x16 slot. It also features Intel® Active Management Technology 12 (iAMT) (Q370 / C246), SATA RAID, as well as PCI Express expansion interfaces, making it specifically suited for applications with added security features.

## 1.1 Features

- LGA1151 socket 9th/8th Generation Intel® Core™ i7/i5/i3, Pentium® and Celeron® processors (Coffee Lake Refresh) up to 95W
- 4 x DDR4 2400/2666MHz DIMM with maximum memory capacity up to 128GB (max. 32GB per slot) (Q370 / C246)
- 2 x DDR4 2400/2666MHz DIMM with maximum memory capacity up to 64GB (max. 32GB per slot) (H310)
- DVI-D, HDMI, Displayport++ and VGA with triple view support (Q370 / C246)
- DVI-D, HDMI, Displayport++ and VGA with double view support (H310)
- 6 x SATA-600 RAID 0/1/5/10 (Q370 / C246)
- 4 x SATA-600 (H310)
- 2 x USB3.1 (Gen2), 4 x USB 3.1 (Gen1) and 7 x USB 2.0 ports (Q370 / C246)
- 4 x USB 3.1 (Gen1) and 5 x USB 2.0 ports (H310)
- 1 x SIM slot
- PCI Express Mini Card support

## 1.2 Specifications

- **CPU**
  - LGA1151 Socket 9th/8th Generation Intel® Core™ i7/ i5/ i3, Pentium® and Celeron® processor.
- **Chipset**
  - Intel® Q370. (IMB523R)
  - Intel® H310. (IMB524R)
  - Intel® C246. (IMB525R)
- **BIOS**
  - AMI BIOS.
- **System Memory**
  - Q370:
    - 4 x 288-pin DIMM sockets.
    - Maximum 128GB DDR4 memory (max. 32GB per slot).
    - Supports 2400/2666MHz.
  - H310:
    - 2 x 288-pin DIMM sockets.
    - Maximum 64GB DDR4 memory (max. 32GB per slot).
    - Supports 2400/2666MHz.
  - C246:
    - 4 x 288-pin DIMM sockets.
    - Maximum 128GB DDR4 memory (max. 32GB per slot).
    - Supports 2400/2666MHz.
    - Supports the memory with ECC function. (Core™ i5/i7 only support non-ECC).
- **Onboard Multi I/O**
  - 1 x PS/2 keyboard and mouse.
  - Six serial ports:
    - 4 x RS-232 (internal box headers).
    - 2 x RS-232/422/485 (one in rear I/O, and the other in internal box header).



- **USB Interface**
  - Q370 / C246:
    - 2 x USB3.1(Gen2) ports.
    - 4 x USB 3.1(Gen1) ports.
    - 7 x USB 2.0 ports.
  - H310:
    - 4 x USB 3.1(Gen1) ports.
    - 5 x USB 2.0 ports.
  
- **Ethernet**
  - LAN1: 1000/100/10Mbps Gigabit/Fast Ethernet supports Wake-on-LAN, PXE Boot ROM, iAMT (Q370 / C246) with Intel® i219LM.
  - LAN2: 1000/100/10Mbps Gigabit/Fast Ethernet supports Wake-on-LAN, PXE Boot ROM with Intel® i211AT.
  
- **Serial ATA**
  - Q370 / C246:
    - 5 x SATAIII with RAID 0/1/5/10.
  - H310:
    - 4 x SATAIII.
  
- **Audio**
  - Realtek ALC662 HDA Codec.
  - Supports MIC-in/line-in/line-out.
  
- **Display**
  - 1 x 15-pin D-Sub as VGA connector. Resolution max. up to 1920x1200 @60Hz.
  - 1 x HDMI 1.4b with max. resolution up to 4096x2160 @24Hz.
  - 1 x Displayport with max. resolution up to 4096 x 2304 @60Hz
  - 1 x DVI-D with resolution max. up to 1920x1200 @60Hz.
  
- **Expansion Interface**
  - Q370 / C246:
    - 1 x PCI-Express x16 slot.
    - 2 x PCI-Express x4 slots.
    - 4 x PCI slots.
    - 1 x Mini PCIe connector w/ SIM slot.
  - H310:
    - 1 x PCI-Express x16 slot.
    - 2 x PCI-Express x4 slots.(with PCIe x1 signal)
    - 4 x PCI slots.
  
- **Power Input**
  - One ATX power input connector.
  - One 12V ATX power input connector for CPU Power.
  
- **Operating Temperature**
  - 0°C ~ 60°C.
  
- **Storage Temperature**
  - -20°C ~ 75°C.
  
- **Form Factor**
  - 305 x 244mm.



**Note**

*All specifications and images are subject to change without notice.*



**Note**

The performance of the system could be adversely affected at an over spec operating temperature or with an unrecommended processor.

## 1.3 Packing list

- **Bulk packing**
  - 1 x Motherboard
  - 1 x I/O bracket
- **Gift box**
  - 1 x Motherboard
  - 1 x I/O bracket

# Chapter 2

## Board and Pin Assignments

### 2.1 Board Layout

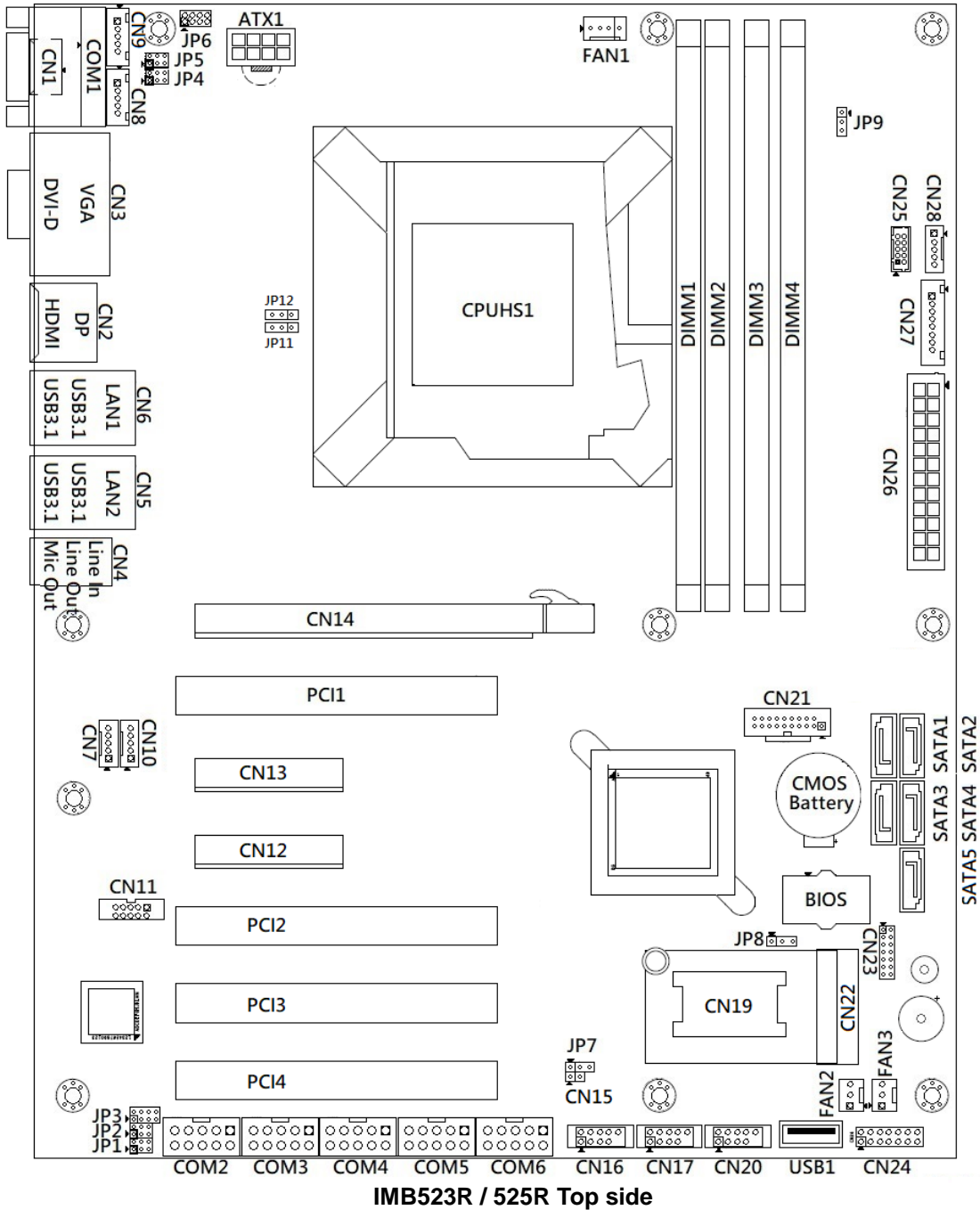

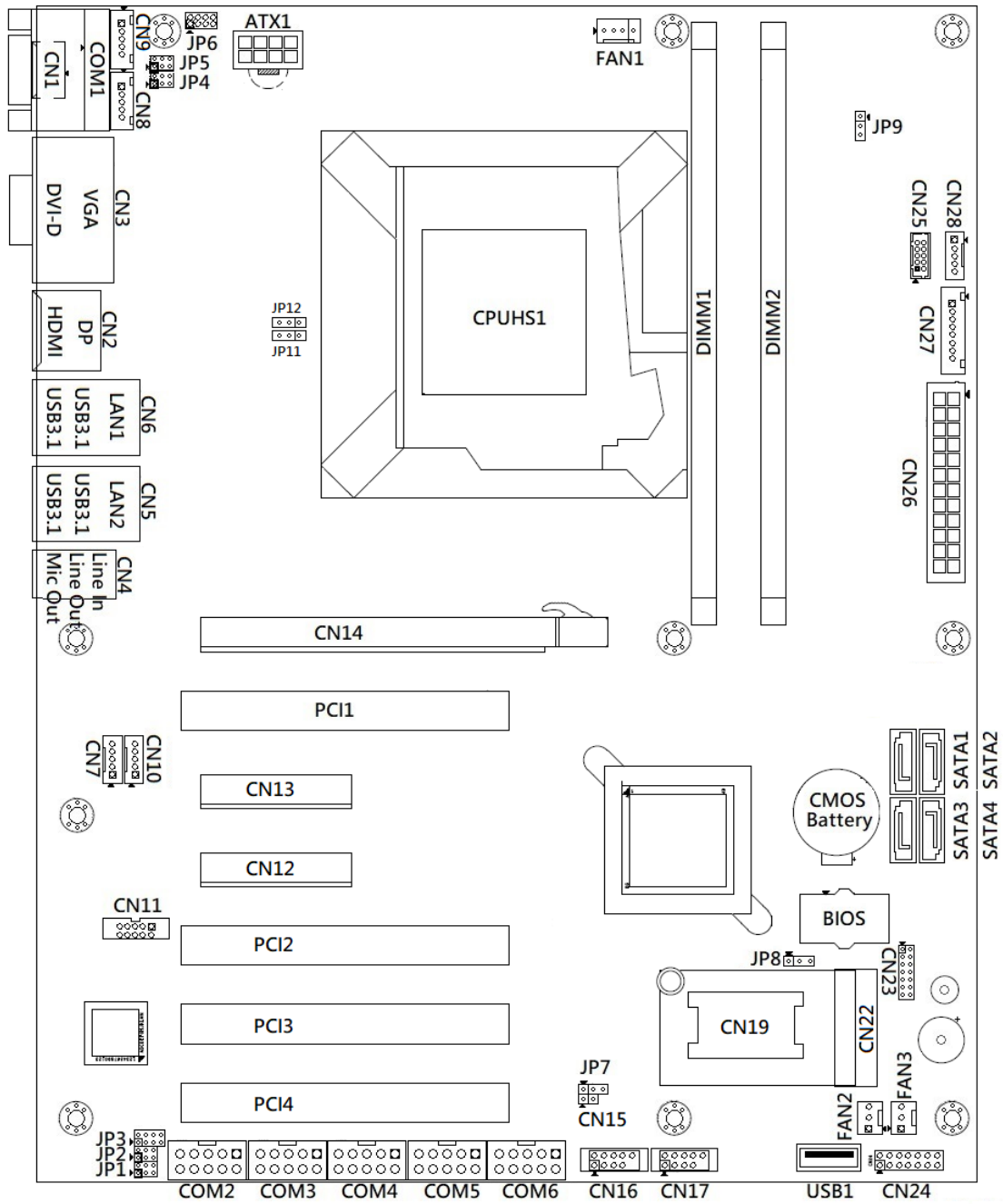

IMB524R Top side

## 2.2 Rear I/O



I/O side

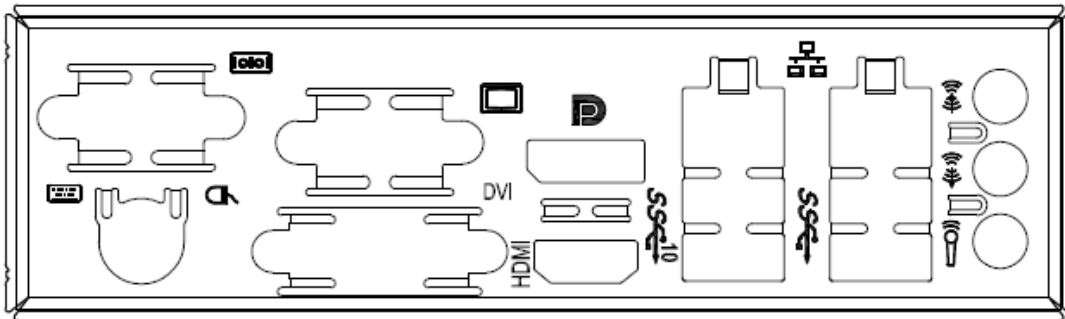

I/O bracket

## 2.3 Block Diagram

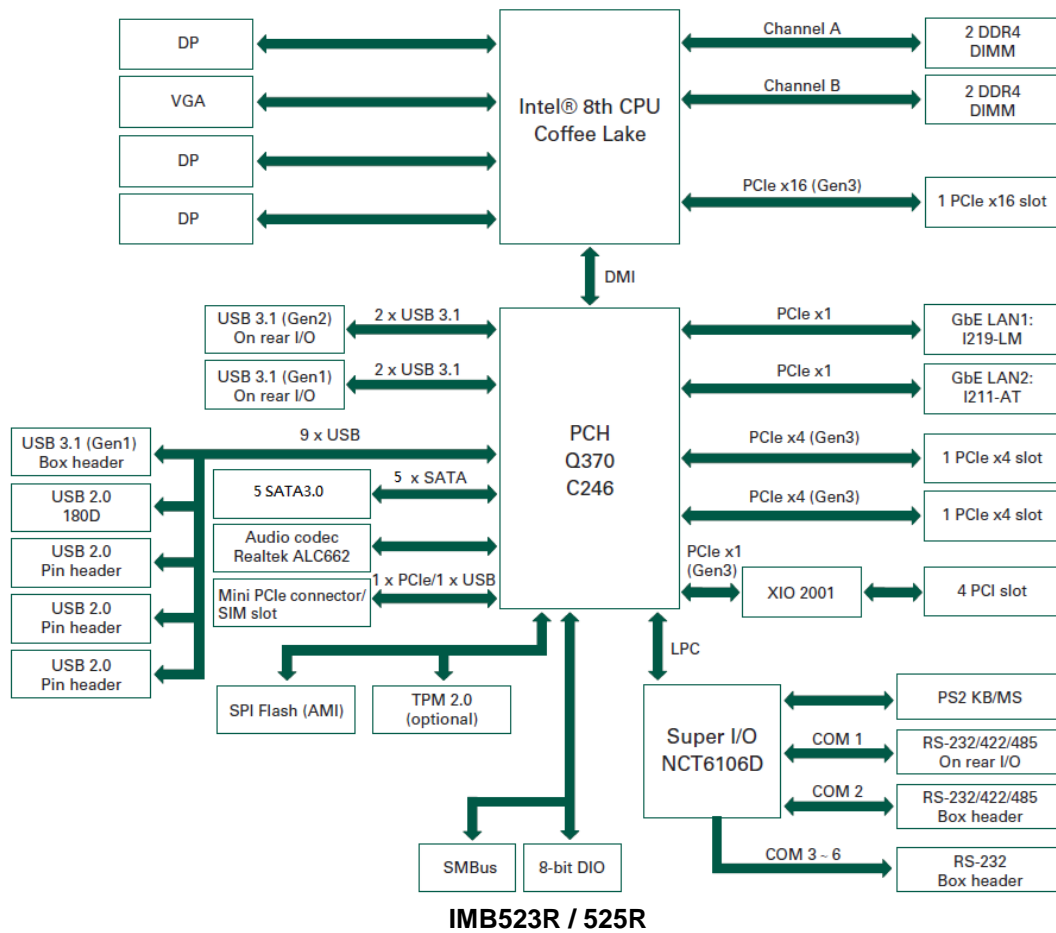

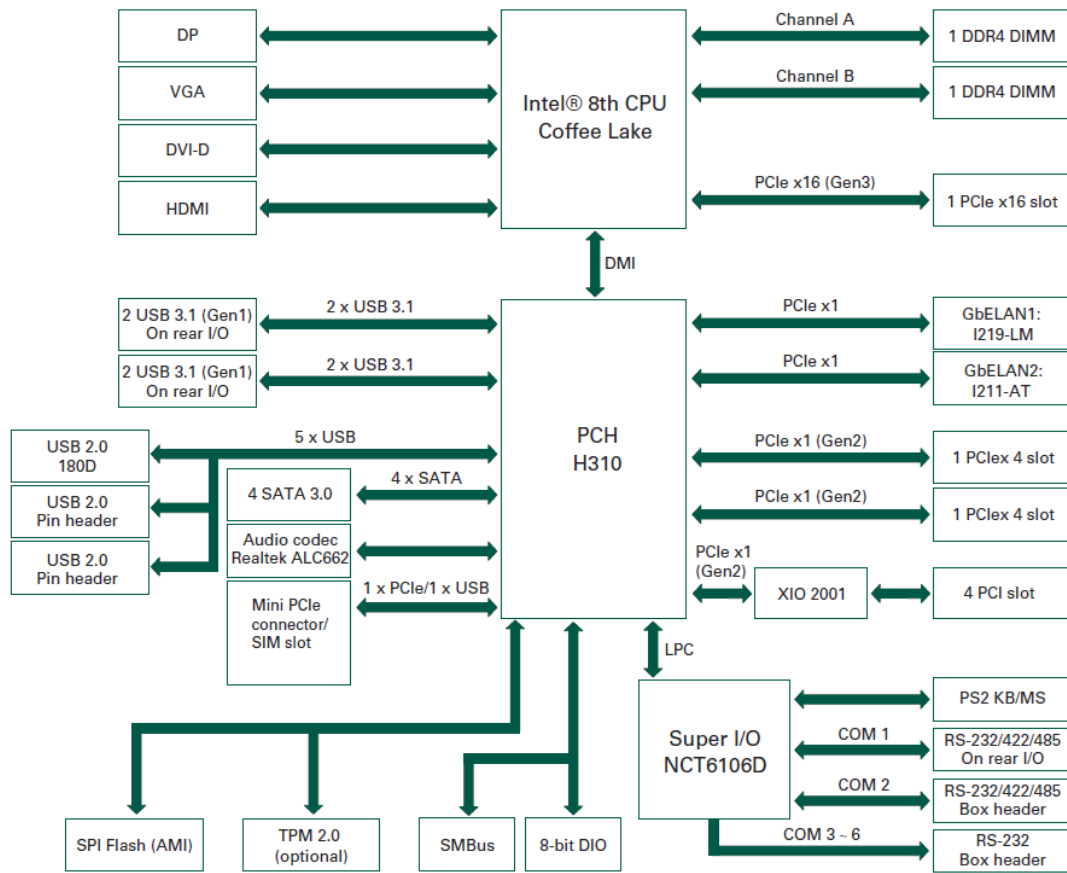

IMB524R

## 2.4 Jumper Settings

### Pin description

A jumper is a small component consisting of a jumper clip and jumper pins. Install a jumper clip on two jumper pins to close the jumper pins. Remove the jumper clip from two jumper pins to open the jumper pins. The following illustration shows how to set up a jumper.

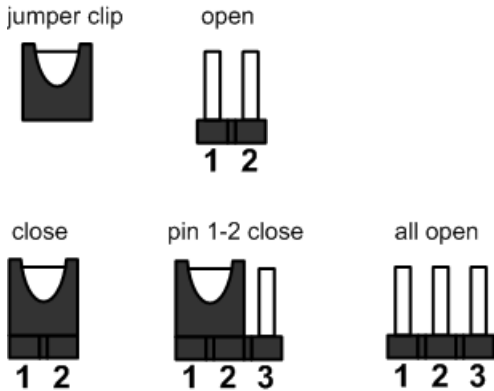

Note

To identify the first pin of a header or jumper, please refer to the following information:

- Usually, there is a thick line or a triangle near the header or jumper pin 1.

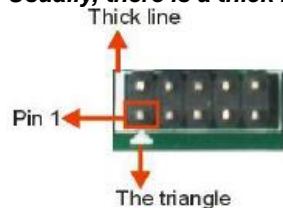

- A square pad, which you can find on the back of the motherboard, is usually used for pin 1.



Before applying power to the IMB523R / 524R / 525R series, make sure all of the jumpers are in factory default position. Below you can find a summary table of all jumpers and onboard default settings.



Note

Turn off power before changing any default jumper settings.

Jumper	Description	Setting
JP8	Clear CMOS Default: Normal Operation	1-2 Close
JP9	AT/ATX Power Mode Select Default: ATX Mode	2-3 Close
JP3, JP6	COM1/2 RS-232/422/485 Mode Select Default: RS-232	1-2 Close
JP1, JP2		3-5, 4-6 Close
JP4, JP5		3-5, 4-6 Close
JP7	System Temperature Sensor Source Select Default: Internal Sensor External Sensor can be installed on CN15	2-3 Close



JP11,JP12	PCIe x16 slot Default: x16	1-2 Close 1-2 Close
-----------	-------------------------------	------------------------

### 2.4.1 Clear CMOS (JP8)

This jumper (3x1-pin p=2.54mm) allows you to clear the Real Time Clock (RTC) RAM in CMOS. You can clear the CMOS memory of date, time, and system setup parameters by erasing the CMOS RTC RAM data. The onboard button cell battery powers the RAM data in CMOS, which includes system setup information such as system passwords.

To erase the RTC RAM:

1. Turn OFF the computer and unplug the power cord.
2. Remove the onboard battery.
3. Move the jumper clip from pins 1-2 (default) to pins 2-3. Keep the clip on pins 2-3 for about 5~10 seconds, then move the clip back to pins 1-2.
4. Re-install the battery.
5. Plug the power cord and turn ON the computer.
6. Hold down the <Del> key during the boot process and enter BIOS setup to re-enter data.

Function	Setting
Normal operation (Default)	1-2 close
Clear CMOS	2-3 close



### 2.4.2 AT/ATX Mode Select (JP9)

This 3x1-pin p=2.54mm jumper allows you to select AT or ATX power mode.

Function	Setting
AT mode	1-2 close
ATX mode (Default)	2-3 close

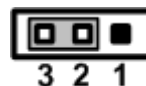

### 2.4.3 COM1 Mode Select (JP4, JP5, JP6)

Use these jumpers (3x2-pin p=2.54mm) to set COM1 port to operate in RS-232, RS-422 or RS-485 communication mode.

Function	Setting
RS-232 mode (Default)	JP6 1-2 close JP4 3-5, 4-6 close JP5 3-5, 4-6 close
RS-422 mode	JP6 3-4, 7-8 close JP4 1-3, 2-4 close JP5 1-3, 2-4 close
RS-485 mode	JP6 5-6, 7-8 close JP4 1-3, 2-4 close JP5 1-3, 2-4 close

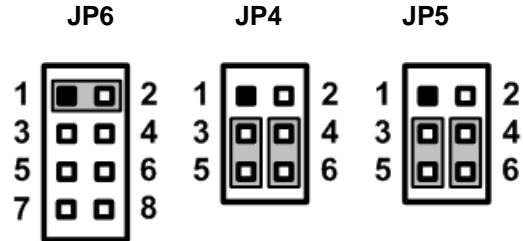

### 2.4.4 COM2 Mode Select (JP1, JP2, JP3)

Use these jumpers (3x2-pin p=2.54mm) to set COM1 port to operate in RS-232, RS-422 or RS-485 communication mode.

Function	Setting
RS-232 mode (Default)	JP3 1-2 close JP1 3-5, 4-6 close JP2 3-5, 4-6 close
RS-422 mode	JP3 3-4, 7-8 close JP1 1-3, 2-4 close JP2 1-3, 2-4 close
RS-485 mode	JP3 5-6, 7-8 close JP1 1-3, 2-4 close JP2 1-3, 2-4 close

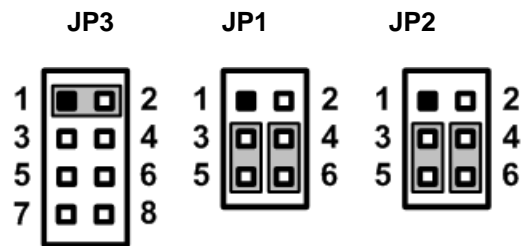

### 2.4.5 Temperature Sensor Source Select

Use these jumpers (3x1-pin p=2.54mm) to set temperature sensor source to operate form external or onboard mode.

Function	Setting
External Sensor	1-2 close
Onboard Sensor(Default)	2-3 close



**Note**

*An external sensor can be installed at CN15.*

## 2.4.6 PCIe x16 slot bifurcation(CN14)

Use these jumpers (3x1-pin p=2.54mm) to set signal of PCIe x16 slot.

CN14	JP11	JP12
x16(Default)	1-2	1-2
x8 x8	2-3	1-2
x8 x4 x4	2-3	2-3



## 2.5 Connectors

Signals go to other parts of the system through connectors. Loose or improper connection might cause problems, Make sure all connectors are properly and firmly connected. Here is a summary table showing the connectors on the hardware.

Connector	Description
CN1	PS/2 KB/MS Connector
CN2	DP/HDMI Connector
CN3	DVI-D/ VGA Connector
CN4	Audio Jack
CN5	RJ45 + USB3.1 GEN1 Connector
CN6	RJ45 (iAMT)+ USB3.1 GEN2 Connector
CN8, CN9	Internal PS/2 KB/MS Connector
CN11	Front Audio Header
CN12, CN13	PCI-Express x4 Slots
CN14	PCI-Express x16 Slots
CN15	External Sensor Connector
CN16, CN17, CN20	Internal USB2.0 Headers
CN19	SIM Slot (Optional)
CN21	Internal USB3.1 GEN1 Connector
CN22	Mini PCI-Express Connector (Optional)
CN23	TPM 2.0 Connector (Optional)
CN24	Front Panel Header
CN25	DIO Connector
CN26	24-pin Power Input Connector
CN27	Voltage Monitor Header
CN28	SMBus Header
ATX1	CPU Power Input Connector
COM1	Comport Connector
COM2 ~ COM6	Comport Box Header
FAN1	CPU Fan Connector
FAN2, FAN3	System Fan Connectors
PCI1 ~ PCI4	PCI Slots
SATA1 ~ SATA6	SATA III Connector
DIMM1 ~ DIMM4	DIMM Sockets

### 2.5.1 Keyboard and PS/2 Mouse Connector (CN1)

The board supports a keyboard and mouse interface. Connector CN1 is a DIN connector for PS/2 keyboard connection via a Y-Cable.

Pin	Signal
1	Keyboard Data
2	Mouse Data
3	GND
4	VCC
5	Keyboard Clock
6	Mouse Clock

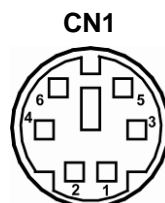

### 2.5.2 DisplayPort++ and HDMI Connector (CN2)

CN2 is a double-deck connector comprising an upper connector for DisplayPort++ (CN2A) and a lower connector for HDMI (CN2B).

Pin	Signal	Pin	Signal
1	LANE 0	21	DATA2
2	GND	22	GND
3	LANE 0#	23	DATA2#
4	LANE 1	24	DATA1
5	GND	25	GND
6	LANE 1#	26	DATA1#
7	LANE 2	27	DATA0
8	GND	28	GND
9	LANE 2#	29	DATA1#
10	LANE 3	30	Clock
11	GND	31	GND
12	LANE 3#	32	Clock#
13	Detect Pin	33	NC
14	GND	34	NC
15	AUX CH	35	SCL
16	GND	36	SDA
17	AUX CH#	37	GND
18	Hot Plug Detect	38	+5V POWER
19	GND	39	Hot Plug Detect
20	DP_PWR(3.3V)		

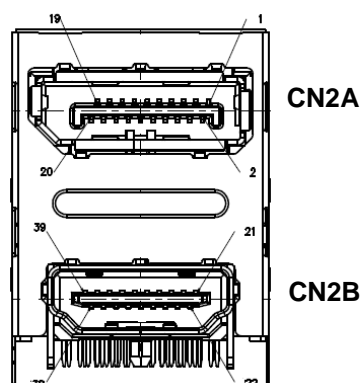

### 2.5.3 VGA and DVI-D Connector (CN3)

CN3 is a double-deck connector comprising an lower connector for DVI-D port and a upper connector for VGA port.

The high rise DVI-D connector provides transmission of fast and high quality video signals between a source device (graphic card) and a display device (monitor).

Pin	Signal	Pin	Signal
1	TX2-	2	TX2+
3	Ground	4	NC
5	NC	6	DVI_SPD_CLK
7	DVI_SPD DATA	8	NC
9	TX1-	10	TX1+
11	Ground	12	NC
13	NC	14	VGAVCC
15	Ground	16	HPDETECT
17	TX0-	18	TX0+
19	Ground	20	NC
21	NC	22	Ground
23	TXC+	24	TXC-

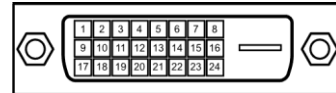

The 15-pin D-Sub connector is commonly used for VGA display.

Pin	Signal	Pin	Signal
1	Red	2	Green
3	Blue	4	NC
5	GND	6	GND
7	GND	8	GND
9	VCC	10	GND
11	NC	12	DDC DATA
13	Horizontal Sync	14	Vertical Sync
15	DDC CLK		

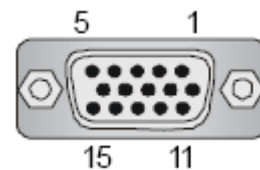

### 2.5.4 Audio Jack (CN4)

Install an audio driver, and then attach audio devices to CN4.

Pin Color	Signal
Blue	Line-in
Green	Line-out
Pink	MIC-in



## 2.5.5 LAN and USB 3.1 Connectors (CN5 and CN6)

The motherboard comes with two high performance plug and play Ethernet interfaces (RJ-45) which are fully compliant with the IEEE 802.3 standard. Connection can be established by plugging one end of the Ethernet cable into this RJ-45 connector and the other end to a 1000/100/10 Base-T hub.

The Universal Serial Bus (compliant with USB 3.1 Gen2 (CN6) or USB3.1 Gen1 (CN5)) connectors on the rear I/O are for installing USB peripherals such as a keyboard, mouse, scanner, etc.

Pin	LAN Signal	Pin	LAN Signal
L1	Tx+ (Data transmission positive)	L2	Tx- (Data transmission negative)
L3	Rx+ (Data reception positive)	L4	RJ-1 (For 1000 Base-T only)
L5	RJ-1 (For 1000 Base-T only)	L6	Rx- (Data reception negative)
L7	RJ-1 (For 1000 Base-T only)	L8	RJ-1 (For 1000 Base-T only)
A	100 LAN LED (Green) / 1000 LAN LED (Orange)	B	Active LED

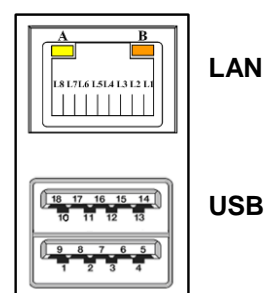

Note

- Speed LED turns orange for 1000Mbps or green for 100Mbps. The light is off for 10Mbps.
- CN6 supports AMT and USB3.1 GEN 2 when the chipset is customized into Intel® Q370 & C246. Both CN5 and CN6 support Wake-on-LAN.

Pin	USB Signal	Pin	USB Signal
1	USB3_POWER	2	USB1 -
3	USB1 +	4	GND
5	USB3_SSRX1-	6	USB3_SSRX1+
7	GND	8	USB3_SSTX1-
9	USB3_SSTX1+	10	USB3_POWER
11	USB2 -	12	USB2 +
13	GND	14	USB3_SSRX2-
15	USB3_SSRX2+	16	GND
17	USB3_SSTX2-	18	USB3_SSTX2+

## 2.5.6 Internal Keyboard Connector (CN8)

The internal keyboard interface is available through a 5-pin connector.

Pin	Signal
1	Keyboard Clock
2	Keyboard Data
3	NC
4	GND
5	+5V level

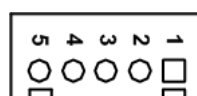

### 2.5.7 Internal Mouse Connector (CN9)

The internal mouse interface is available through a 5-pin connector.

Pin	Signal
1	Mouse Clock
2	Mouse Data
3	NC
4	GND
5	+5V level

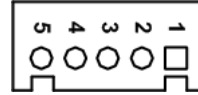

### 2.5.8 Front Audio Header (CN11)

This is a front audio header (5x2-pin p=2.00mm) for convenient connection and control of audio devices.

Pin	Signal	Pin	Signal
1	MIC_IN	2	GND
3	LINE_IN_L	4	GND
5	LINE_IN_R	6	GND
7	AUD_OUT_L	8	GND
9	AUD_OUT_R	10	GND

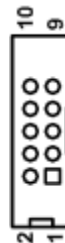



## 2.5.9 PCI-Express x4 Slots (CN12 and CN13)

This motherboard has two PCI-Express x4 slots.

Pin	Signal	Pin	Signal
B1	+12V_PS	A1	GND
B2	+12V_PS	A2	+12V_PS
B3	+12V_PS	A3	+12V_PS
B4	GND	A4	GND
B5	SMB_CLK_RESUME	A5	N/C
B6	SMB_DATA_RESUME	A6	N/C
B7	GND	A7	N/C
B8	+3.3V_PS	A8	N/C
B9	N/C	A9	+3.3V_PS
B10	+3.3V_SB	A10	+3.3V_PS
B11	PCH_WAKE_N	A11	PWRGD
B12	N/C	A12	GND
B13	GND	A13	CLKOUT_PCIE_P5
B14	PCIE1_SLOT1_TX_DP_C	A14	CLKOUT_PCIE_N5
B15	PCIE1_SLOT1_TX_DN_C	A15	GND
B16	GND	A16	PCIE1_SLOT1_RX_DP_C
B17	PCIEX4_SLOT1_PRSENT2_N	A17	PCIE1_SLOT1_RX_DN_C
B18	GND	A18	GND
B19	PCIE2_TX_DP	A19	N/C
B20	PCIE2_TX_DN	A20	GND
B21	GND	A21	PCIE2_RX_DP
B22	GND	A22	PCIE2_RX_DN
B23	PCIE3_TX_DP	A23	GND
B24	PCIE3_TX_DN	A24	GND
B25	GND	A25	PCIE3_RX_DP
B26	GND	A26	PCIE3_RX_DN
B27	PCIE4_TX_DP	A27	GND
B28	PCIE4_TX_DN	A28	GND
B29	GND	A29	PCIE4_RX_DP
B30	N/C	A30	PCIE4_RX_DN
B31	N/C	A31	GND
B32	GND	A32	N/C

### 2.5.10 PCIe x16 slot (CN14)

CN14	JP11	JP12
x16(Default)	1-2	1-2
x8 x8	2-3	1-2
x8 x4 x4	2-3	2-3



### 2.5.11 External Sensor Header (CN15)

The external sensor header is an 1x2-pin p=2.54mm header. The function of CN15 is to connect an external sensor.

Pin	Signal
1	Sys_Temp
2	GND



Note

JP7 should be 1-2 closed for the external sensor on CN15.

### 2.5.12 Internal USB Headers (CN16~CN17, CN20, USB1)

These are 5x2-pin p=2.54mm headers for USB 2.0 interface.

Pin	Signal	Pin	Signal
1	+5 V_DUAL	2	+5 V_DUAL
3	USB 5, 7, 12-	4	USB 6, 8, 13-
5	USB 5, 7, 12+	6	USB 6, 8, 13+
7	GND	8	GND
		10	GND

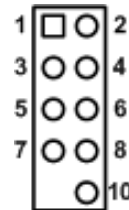

The USB1 is a Type-A 180D connector for USB2.0 signal.

Pin	Signal
1	+5V_DUAL
2	USB-
3	USB+
4	GND

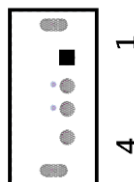

### 2.5.13 SIM Card Slots (CN19)

The motherboard includes one SIM slot on the bottom side of the system for inserting a SIM card. It is mainly used in 3G/4G wireless network applications.

Pin	Signal
1	PWR
2	RST
3	CLK
4	NC
5	GND
6	VPP
7	I/O
8	NC

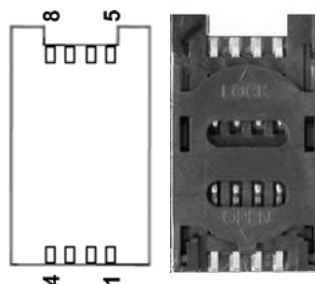

### 2.5.14 Internal USB 3.1 Gen1 Connector (CN21)

The CN21 is a 19-pin internal connector for installing versatile USB 3.1 compliant peripherals.

Pin	Signal	Pin	Signal
1	VBUS0		
2	SSRX5-	19	VBUS1
3	SSRX5+	18	SSRX6-
4	GND	17	SSRX6+
5	SSTX5-	16	GND
6	SSTX5+	15	SSTX6-
7	GND	14	SSTX6+
8	USB10-	13	GND
9	USB10+	12	USB11-
10	ID	11	USB11+

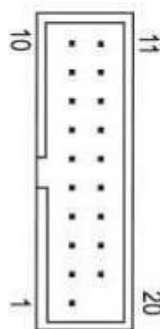

Note

- CN21 supports USB3.1 GEN 1 when the chipset is customized into Intel® Q370 & C246.

### 2.5.15 Mini PCI-Express Connector (CN22)

Pin	Signal	Pin	Signal
1	WAKE#	2	+3.3V_DUAL
3	N/C	4	GND
5	N/C	6	+1.5V
7	CLKREQ#	8	UIM_PWR
9	GND	10	UIM_DATA
11	REFCLK-	12	UIM_CLK
13	REFCLK+	14	UIM_RESET
15	GND	16	UIM_VPP
17	N/C	18	GND
19	N/C	20	W_DISABLE#
21	GND	22	PERST#
23	PE_RXN7	24	+3.3V_DUAL
25	PE_RXP7	26	GND
27	GND	28	+1.5V
29	GND	30	SMB_CLK_RESUME
31	PE_TXN7	32	SMB_DATA_RESUME
33	PE_TXP7	34	GND
35	GND	36	USB3-
37	GND	38	USB3+
39	+3.3V_DUAL	40	GND
41	+3.3V_DUAL	42	N/C
43	GND	44	N/C
45	N/C	46	N/C
47	N/C	48	+1.5V
49	N/C	50	GND
51	N/C	52	+3.3V_DUAL

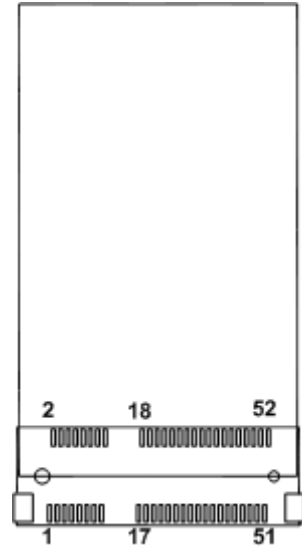

**Screw type is M2\*0.4.**

**Note**

### 2.5.16 TPM Pin Header (CN23)

These are 7x2-pin p=2.0mm headers for SPI interface with an AX93515 TPM module.

Pin	Signal	Pin	Signal
1	VCC3P3	2	GND
3	MOSI	4	MISO
5	CLK	6	CS2
7	RST	8	PIRQ
9	PP	10	NC
11	NC	12	NC
13	NC	14	MC

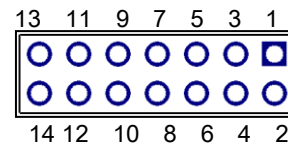

**The screw type is M2\*0.4.**

**Note**

### 2.5.17 Front Panel Header (CN24)

This is a front panel header (7x2-pin p=2.54mm).

Pin	Signal
1	Power LED+
2	SPK- <sup>[*]</sup>
3	GND
4	BUZZER
5	Power LED-
6	N/C
7	N/C
8	SPK+ <sup>[*]</sup>
9	PWR-
10	PWR+
11	RESET-
12	RESET+
13	HD LED-
14	HD LED+

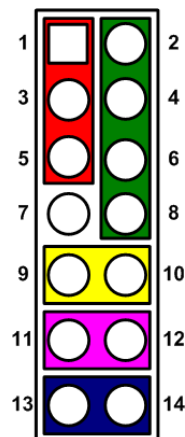

Note

<sup>[\*]</sup>: The buzzer on the motherboard will be active when pin 2 and pin 4 are connected; the external speaker on the chassis will be active when pin 2 and pin 4 are open.

### 2.5.18 GPIO Header (CN25)

This header (5x2-pin p=2.00mm) is for digital I/O interface.

Pin	Signal	Pin	Signal
1	DIO1	2	DIO8
3	DIO2	4	DIO7
5	DIO3	6	DIO6
7	DIO4	8	DIO5
9	NC	10	GND

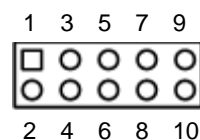

Note

The default value of DIO1 to DIO8 is set as GPI with high level.

### 2.5.19 Power Input Connectors (ATX1 and CN26)

Steady and sufficient power can be supplied to all components on the motherboard by connecting the power connector. Please make sure all components and devices are properly installed before connecting the power connector.

An external power supply plug fits into ATX1 and CN26 in only one orientation. Properly press down power supply plug until it completely and firmly fits into the connector. Loose connection may cause system instability.

ATX1 CPU power input connector:

Pin	ATX1 Signal	Pin	ATX1 Signal
1	GND	5	+12V
2	GND	6	+12V
3	GND	7	+12V
4	GND	8	+12V

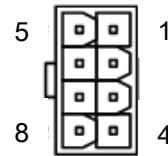

CN26 24-pin power input connector:

Pin	CN26 Signal	Pin	CN26 Signal
1	3.3V	13	3.3V
2	3.3V	14	-12V
3	GND	15	GND
4	+5V	16	PS_ON
5	GND	17	GND
6	+5V	18	GND
7	GND	19	GND
8	PWR OK	20	-5V
9	5VSB	21	+5V
10	+12V	22	+5V
11	+12V	23	+5V
12	3.3V	24	GND

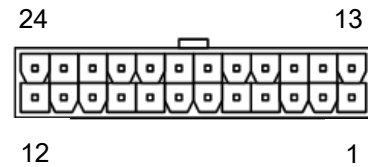

### 2.5.20 Voltage Monitor Header (CN27)

The function of CN27 (8x1-pin p=2.54mm) is for voltage monitoring. It doesn't supply power.

Pin	Signal	Pin	Signal
1	GND	2	GND
3	VCC5_SB	4	+3.3V
5	-5V	6	+5V
7	-12V	8	+12V

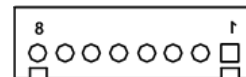

### 2.5.21 SMBus Header (CN28)

The CN28 (5x1-pin p=2.00mm) is for SMBus (System Management Bus) interface.

Pin	Signal	Pin	Signal
1	SMB_SCL	2	N/C
3	GND	4	SMB_SDA
5	+5V		

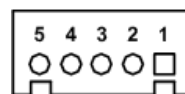

### 2.5.22 COM1 Connector (COM1)

This is a high rise 9-pin D-Sub connector for COM1 serial port interface. The pin assignments of RS-232/422/485 are listed in the table below.

Pin	RS-232 <sup>[*]</sup>	RS-422 <sup>[*]</sup>	RS-485 <sup>[*]</sup>
1	DCD#	TX-	485-
2	RXD	TX+	485+
3	TXD	RX+	N/C
4	DTR#	RX-	N/C
5	GND	GND	GND
6	DSR#	N/C	N/C
7	RTS#	N/C	N/C
8	CTS#	N/C	N/C
9	RI#	N/C	N/C

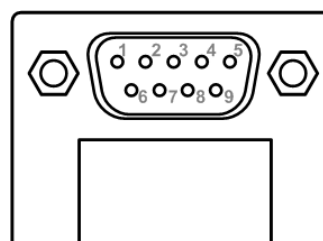

Note

<sup>[\*]</sup>: Signals of COM1 can be RS-232/422/485 by selecting JP4, JP5 and JP6 (see section 2.4.3).

### 2.5.23 COM Headers (COM2 ~ COM6)

The motherboard comes with 5x2-pin p=2.54mm headers for COM2~COM6 serial port interfaces.

#### COM2~COM6:

Pin	Signal	Pin	Signal
1	DCD#	2	DSR#
3	RXD#	4	RTS#
5	TXD#	6	CTS#
7	DTR#	8	RI#
9	GND	10	N/C

#### COM2 ~ COM6

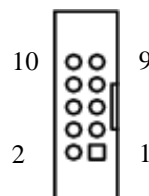

### 2.5.24 Fan Connectors (FAN1~FAN3)

This motherboard has three fan connectors. Find fan speed option(s) at BIOS Setup Utility: Advanced\HW Monitor\PC Health Status.

The FAN1 (4x1-pin p=2.54mm) is for the the CPU fan connector.

Pin	Signal
1	GND
2	+12V
3	FAN Speed Detection
4	FAN Speed Control



The FAN2 and FAN3 (4x1-pin p=2.54mm) are for system fan connectors.

Pin	Signal
1	GND
2	+12V
3	FAN Speed Detection

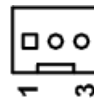

### 2.5.25 SATA 3.0 Connectors (SATA1 ~ SATA6)

These Serial Advanced Technology Attachment (Serial ATA or SATA) connectors are for SATA 3.0 interface allowing up to 6.0Gb/s data transfer rate. It is a computer bus interface for connecting to devices such as hard disk drive.

Pin	Signal
1	GND
2	SATA_TX+
3	SATA_TX-
4	GND
5	SATA_RX-
6	SATA_RX+
7	GND

Q370 / C246:

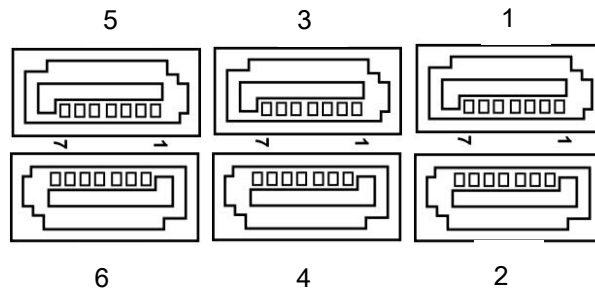

H310:

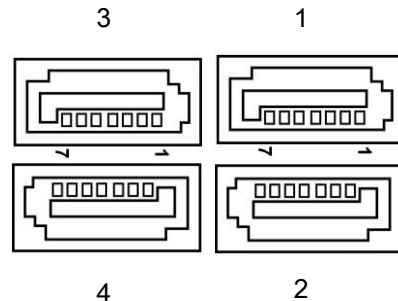



### 2.5.26 DIMM Sockets (DIMM1 ~ DIMM4)

There are four DDR4 DIMM sockets. They are grouped into two memory channels, channel A and channel B. DIMM sockets are arranged in the order as the following diagram. IMB524 has only DIMM sockets 1 and 3.

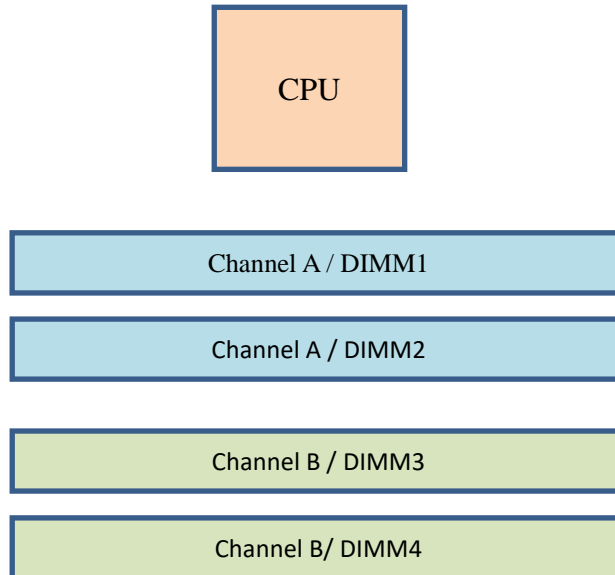

**This page is intentionally left blank.**

# Chapter 3

## Hardware Description

### 3.1 Microprocessors

The IMB523R / 524R / 525R series supports Intel® Core™ i7/ i5/ i3, Pentium® and Celeron® processors, which enable your system to operate under Windows® 10 and Linux environments. The system performance depends on the microprocessor. Make sure all correct settings are arranged for your installed microprocessor to prevent the CPU from damages.



Note

**Caution: Make sure turnoff power supply, before you install the processor into the CPU socket.**

### 3.2 BIOS

The IMB523R / 524R / 525R series uses AMI Plug and Play BIOS.

### 3.3 System Memory

The IMB523R / 525R supports four 288-pin DDR4 DIMM sockets for maximum memory capacity up to 128GB DDR4 SDRAMs. The memory module comes in sizes of 2GB, 4GB, 8GB, 16GB and 32GB.

The IMB524R supports two 288-pin DDR4 DIMM sockets for maximum memory capacity up to 64GB DDR4 SDRAMs. The memory module comes in sizes of 2GB, 4GB, 8GB, 16GB and 32GB.

Up to this document edited, 9<sup>th</sup>/8<sup>th</sup> Gen. Intel® Core™ i3 CPU's, and below, support DDR4 2666/2400. 9<sup>th</sup>/8<sup>th</sup> Gen. Intel® Core™ i7/i5 CPU's support DDR4 2666. This is subject to Intel®'s change. Users are recommended to check Intel®'s web for the most updated information.

**This page is intentionally left blank.**

# Chapter 4

## AMI BIOS Setup Utility

The AMI UEFI BIOS provides users with a built-in setup program to modify basic system configuration. All configured parameters are stored in a flash chip to save the setup information whenever the power is turned off. This chapter provides users with detailed description about how to set up basic system configuration through the AMI BIOS setup utility.

### 4.1 Starting

To enter the setup screens, follow the steps below:

1. Turn on the computer and press <Del> during the Power On Self Test (POST) to enter BIOS setup, otherwise, POST will continue with its test routines.
2. Once you enter the BIOS, the main BIOS setup menu displays. You can access the other setup screens from the main BIOS setup menu, such as the Advanced and Chipset menus.



**Note**

*If your computer cannot boot after making and saving system changes with BIOS setup, you can restore BIOS optimal defaults by setting JP8 (see section 2.4.1).*

It is strongly recommended that you should avoid changing the chipset's defaults. Both AMI and your system manufacturer have carefully set up these defaults that provide the best performance and reliability.

### 4.2 Navigation Keys

The BIOS setup/utility uses a key-based navigation system called hot keys. Most of the BIOS setup utility hot keys can be used at any time during the setup navigation process. These keys include <F1>, <F2>, <Enter>, <ESC>, <Arrow> keys, and so on.



**Note**

*Some of the navigation keys differ from one screen to another.*

Hot Keys	Description
→← Left/Right	The Left and Right <Arrow> keys allow you to select a setup screen.
↑↓ Up/Down	The Up and Down <Arrow> keys allow you to select a setup screen or sub screen.
Enter	The <Enter> key allows you to display or change the setup option listed for a particular setup item. The <Enter> key can also allow you to display the setup sub screens.
+– Plus/Minus	The Plus and Minus <Arrow> keys allow you to change the field value of a particular setup item.
F1	The <F1> key allows you to display the General Help screen.
F2	The <F2> key allows you to Load Previous Values.
F3	The <F3> key allows you to Load Optimized Defaults.
F4	The <F4> key allows you to save any changes you have made and exit Setup. Press the <F4> key to save your changes.
Esc	The <Esc> key allows you to discard any changes you have made and exit the Setup. Press the <Esc> key to exit the setup without saving your changes.

## 4.3 Main Menu

When you first enter the setup utility, you will enter the Main setup screen. You can always return to the Main setup screen by selecting the Main tab. System Time/Date can be set up as described below. The Main BIOS setup screen is shown below.

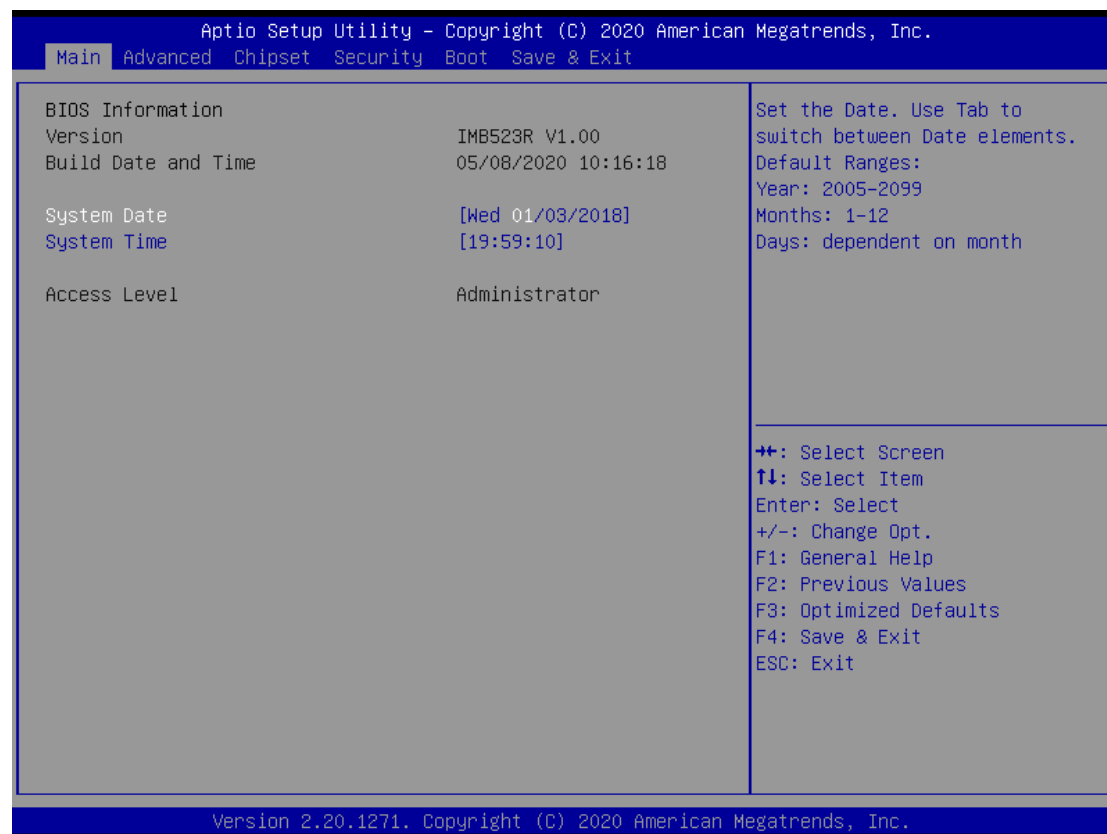

### BIOS Information

Display the BIOS information.

### System Date/Time

Use this option to change the system time and date. Highlight System Time or System Date using the <Arrow> keys. Enter new values through the keyboard. Press the <Tab> key or the <Arrow> keys to move between fields. The date must be entered in MM/DD/YY format. The time is entered in HH:MM:SS format.

### Access Level

Display the access level of current user.

## 4.4 Advanced Menu

The Advanced menu also allows users to set configuration of the CPU and other system devices. You can select any of the items in the left frame of the screen to go to the sub menus:

- ▶ ACPI Settings
- ▶ Trusted Computing
- ▶ Platform Misc Configuration
- ▶ CPU Configuration
- ▶ SATA and RST Configuration
- ▶ NCT6106D Super IO Configuration
- ▶ NCT6106D Hardware Monitor
- ▶ PCH-FW configuration
- ▶ AMT configuration
- ▶ USB Configuration
- ▶ PCI Subsystem Settings
- ▶ CSM Configuration
- ▶ Serial Port Console Redirection

For items marked with “▶”, please press <Enter> for more options.

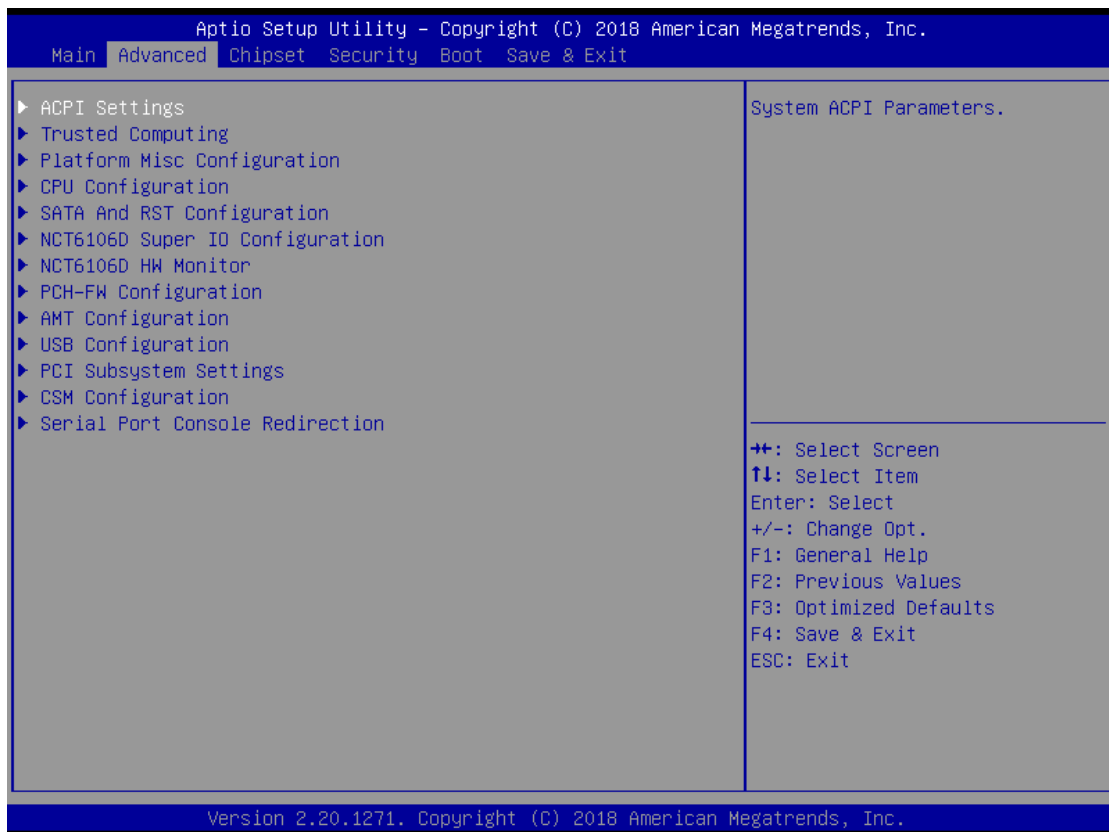



- **ACPI Settings**

This screen shows ACPI Settings.

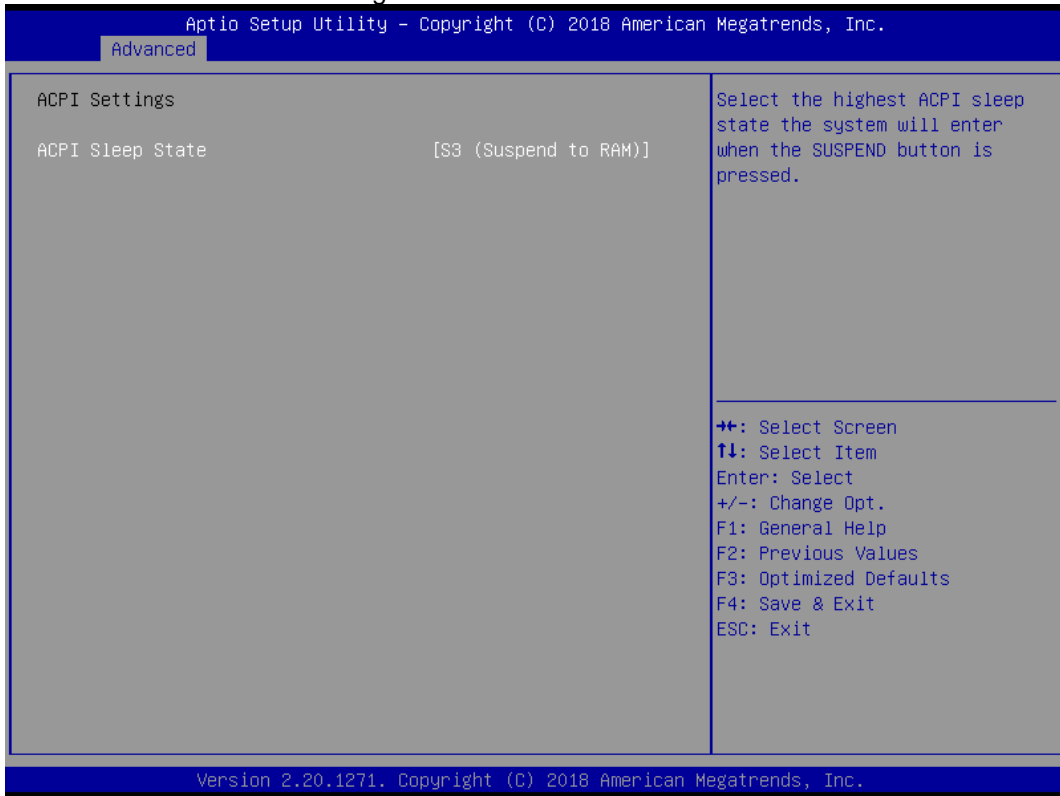

**ACPI Sleep State**

Select the ACPI (Advanced Configuration and Power Interface) sleep state. Configuration options are Suspend Disabled and S3 (Suspend to RAM). The default is S3 (Suspend to RAM). This option selects the ACPI sleep state the system will enter when the suspend button is pressed.

**AMT BIOS Features**

Enable or disable Active Management Technology BIOS features. The default is Enabled.



- **Trusted Computing**

Enable or disable security device support.

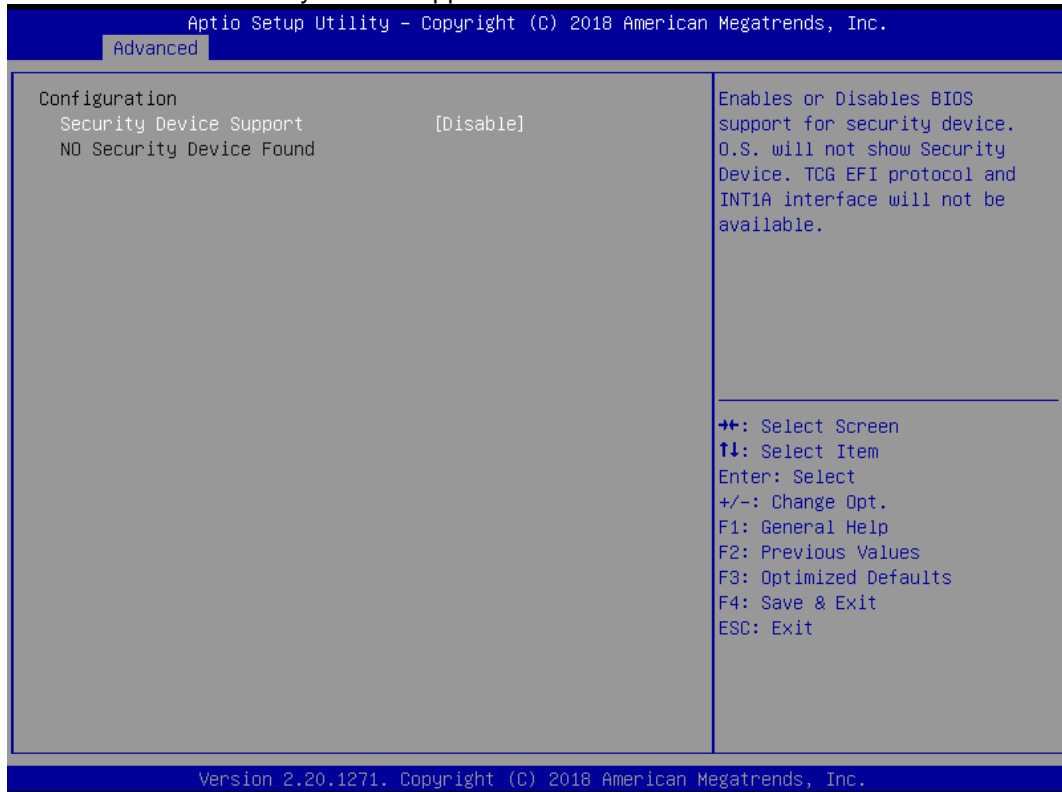

## CPU Configuration

This screen shows CPU information, and you can change the value of the selected option.

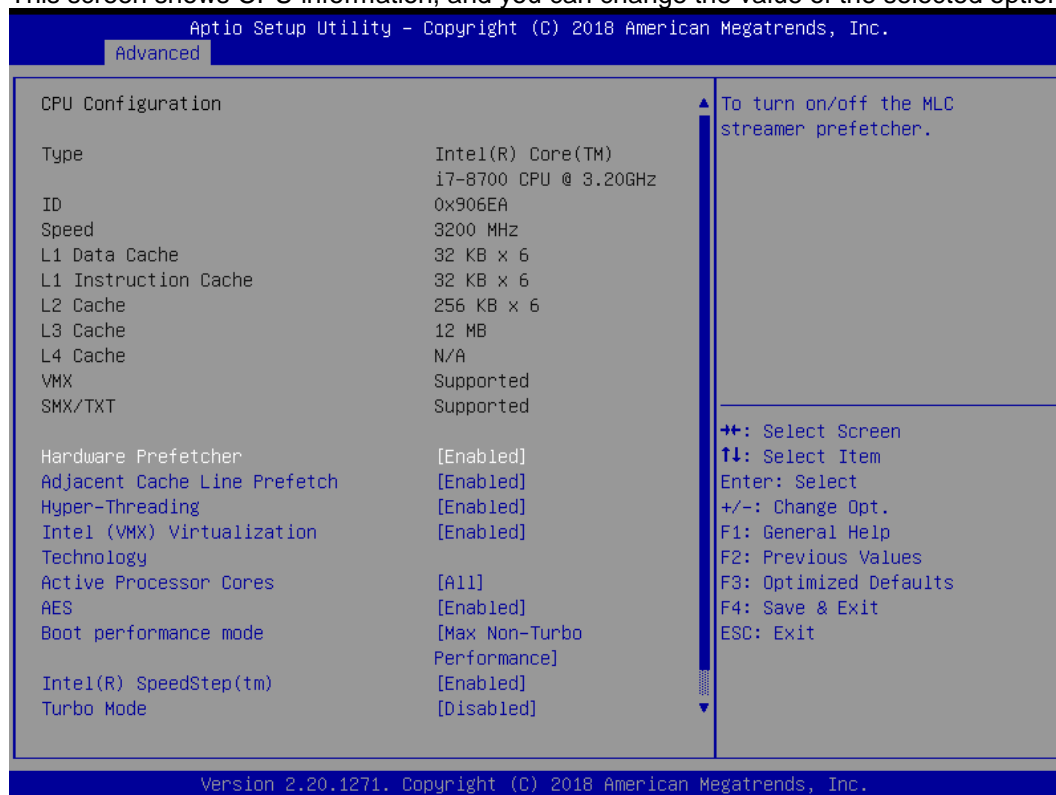

### Hardware Prefetcher

Turn on/off the MLC streamer prefetcher.

### Adjacent Cache Line Prefetch

Turn on/off prefetching of adjacent cache lines.

### Hyper-Threading

Enable or disable Hyper-threading Technology, which allows a single physical processor to multitask as multiple logical processors. When disabled, only one thread per enabled core is enabled.

### Intel Virtualization Technology

Enable or disable Intel Virtualization Technology. When enabled, a VMM (Virtual Machine Mode) can utilize the additional hardware capabilities. It allows a platform to run multiple operating systems and applications independently, hence enabling a single computer system to work as several virtual systems.

### Active Processor Cores

Number of cores to enable in each processor package.

### AES

Enable / Disable AES (Advanced Encryption Standard)

### Boot performance mode

Select the performance state that the BIOS will set starting from reset vector.

### Intel (R) SpeedStep(tm)

Allows more than two frequency ranges to be supported.

**Turbo Mode**

Enable/Disable processor Turbo Mode (requires EMTTM enabled too). AUTO means enabled, unless max turbo ratio is bigger than 16 - SKL A0 W/A.

**C states**

Enable/Disable CPU Power Management, which allows CPU to go to power saving C-states when it's not 100% utilized.

- **Compatibility Support Module (CSM) Configuration**

This screen displays CSM information.

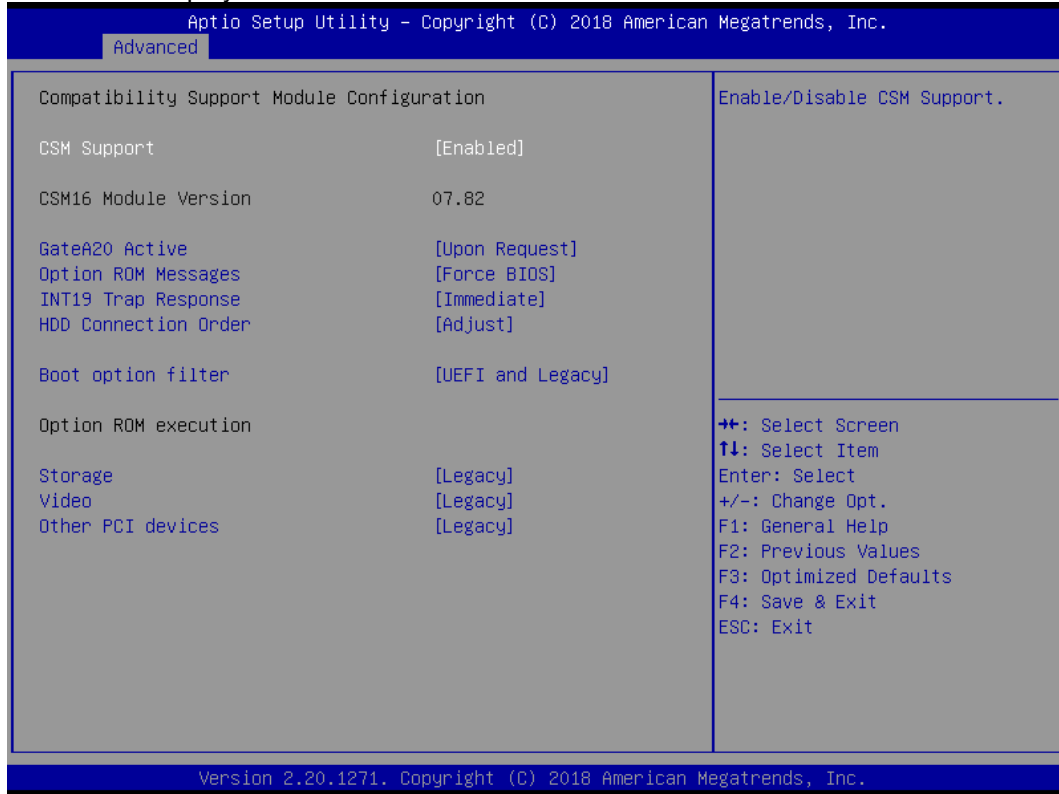

**CSM Support**

Enabled / Disable CSM Support.

**GateA20 Active**

UPON REQUEST - GA20 can be disabled using BIOS services. ALWAYS - do not allow disabling GA20. This option is useful when any RT code is executed above 1MB.

**Option ROM Messages**

Set display mode for Option ROM.

**INT19 Trap Response**

BIOS reaction on INT19 trapping by Option ROM: IMMEDIATE - execute the trap right away; POSTPONED - execute the trap during legacy boot.

**Boot option filter**

This option controls Legacy/UEFI ROMs priority.

**Storage**

Controls the execution of UEFI and Legacy Storage OpROM.

**Video**

Controls the execution of UEFI and Legacy Video OpROM.

**Other PCI devices**

Determines OpROM execution policy for devices other than Network, Storage, or Video.

- **NCT6106D Hardware Monitor**

This screen monitors hardware health status.

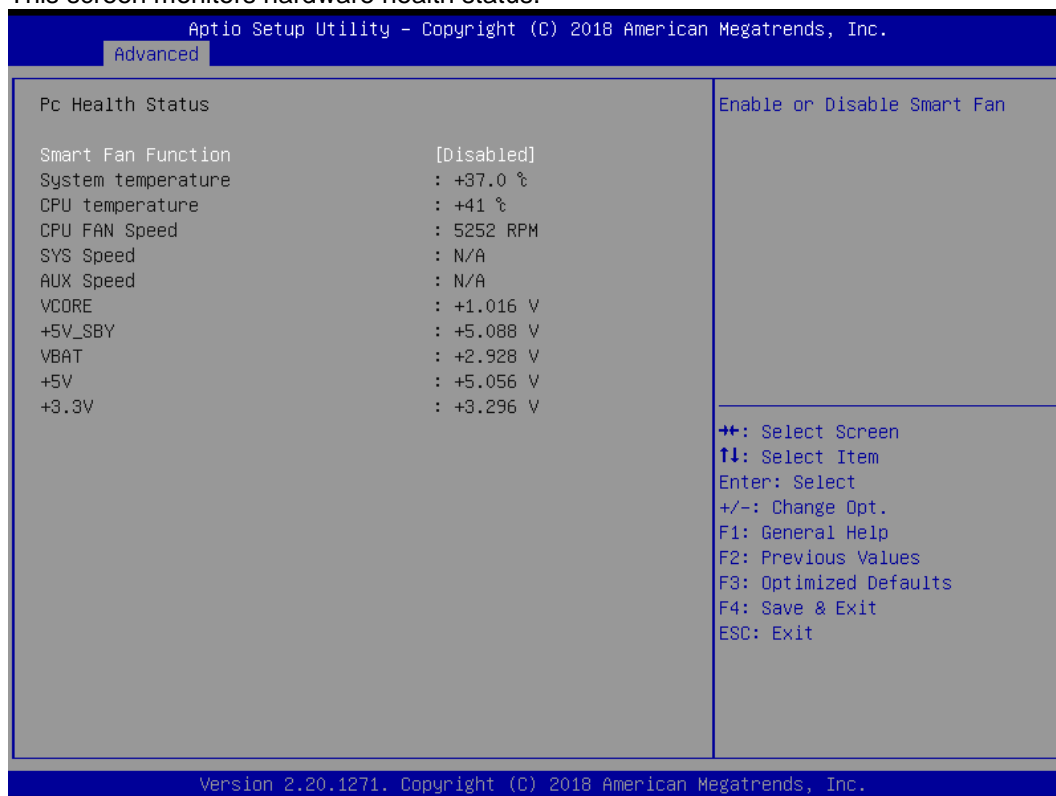

This screen displays the temperature of system and CPU, cooling fans speed in RPM and system voltages (VCC\_CPU, DDR, +12V, +5V and +3.3V).



**CPU FAN = FAN1; SYS FA = FAN2; AUX FAN = FAN3.**

**Note**

### NCT6106D Super IO Configuration

You can use this screen to select options for the Super IO Configuration, and change the value of the selected option. A description of the selected item appears on the right side of the screen. For items marked with "▶", please press <Enter> for more options.

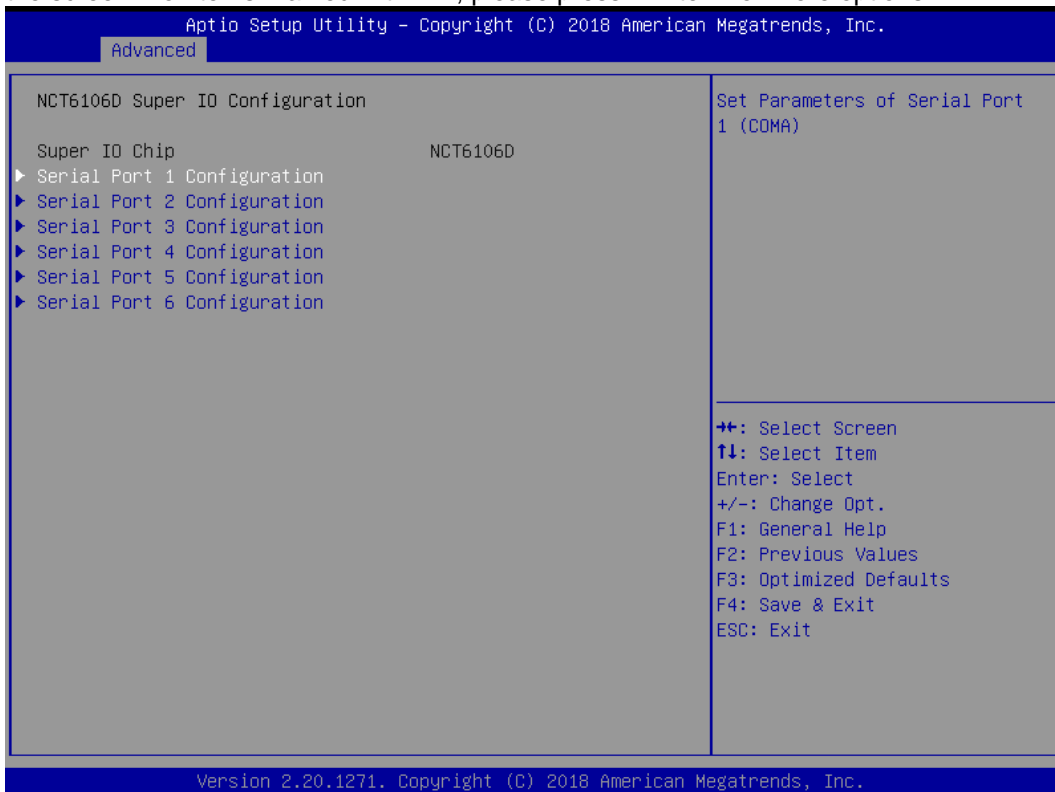

### Serial Port 1~6 Configuration

Use these items to set parameters related to serial port 1~6.

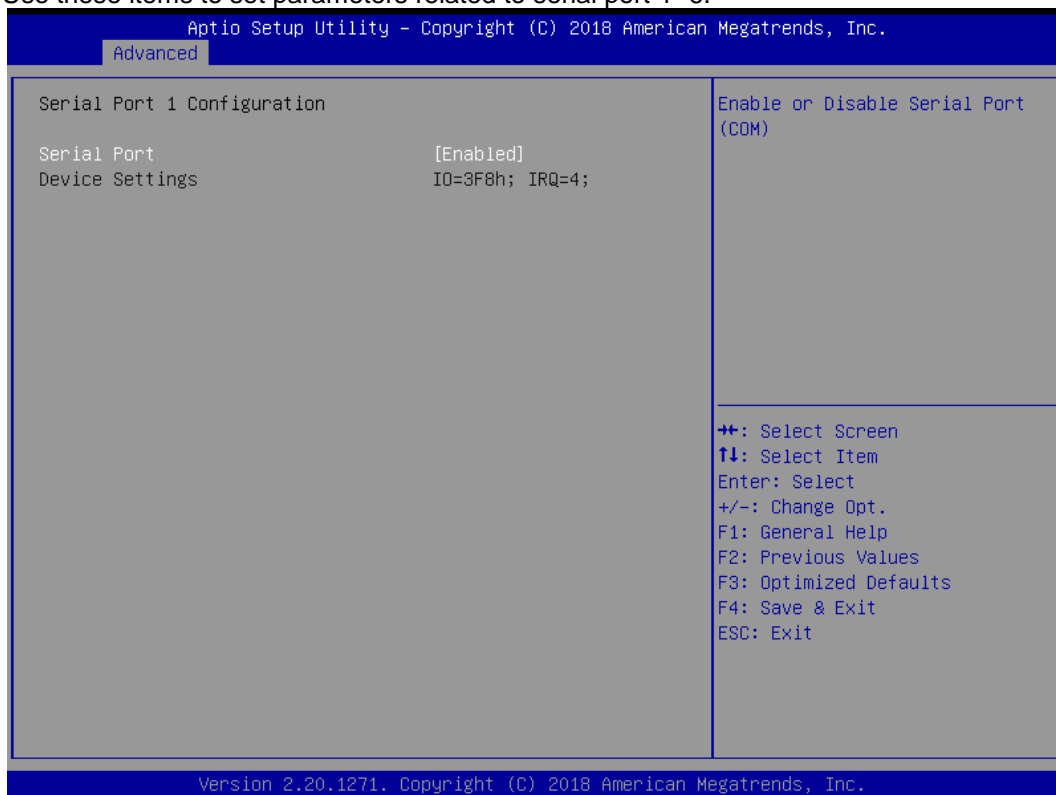

- **PCH-FW Configuration**

This screen displays ME Firmware information.



- **PCI Subsystem Settings**

This screen allows you to set PCI Subsystem mode.

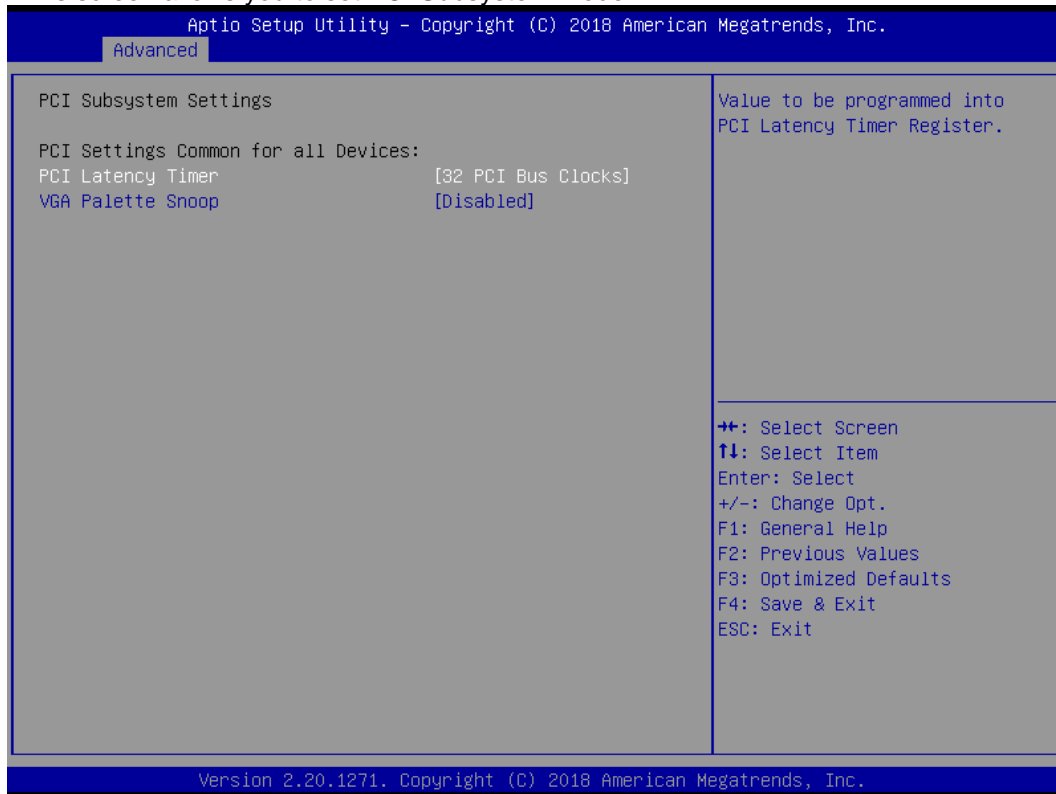

**PCI Latency Timer**

Set the value to be programmed into PCI Latency Timer Register.

**VGA Palette Snoop**

Enables or Disables VGA Palette Registers Snooping.



● **Platform Misc Configuration**

This screen allows you to set Platform Misc Configuration.

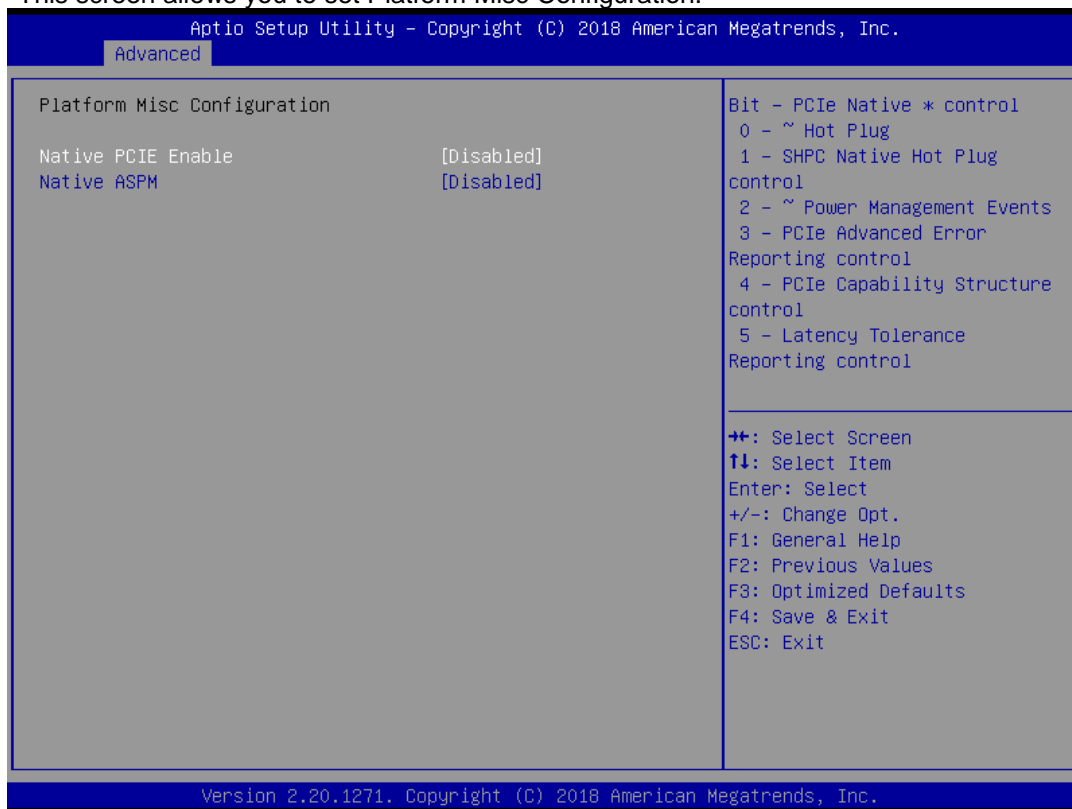

**Native PCIe Enable**

Bit - PCIe Native \* control\n 0 - ~ Hot Plug\n 1 - SHPC Native Hot Plug control\n 2 - ~ Power Management Events\n 3 - PCIe Advanced Error Reporting control\n 4 - PCIe Capability Structure control\n 5 - Latency Tolerance Reporting control.

**Native ASPM**

Enabled - OS Controlled ASPM, Disabled - BIOS Controlled ASPM.

### SATA Configuration

During system boot up, the BIOS automatically detects the presence of SATA devices. In the SATA Configuration menu, you can see the hardware currently installed in the SATA ports.

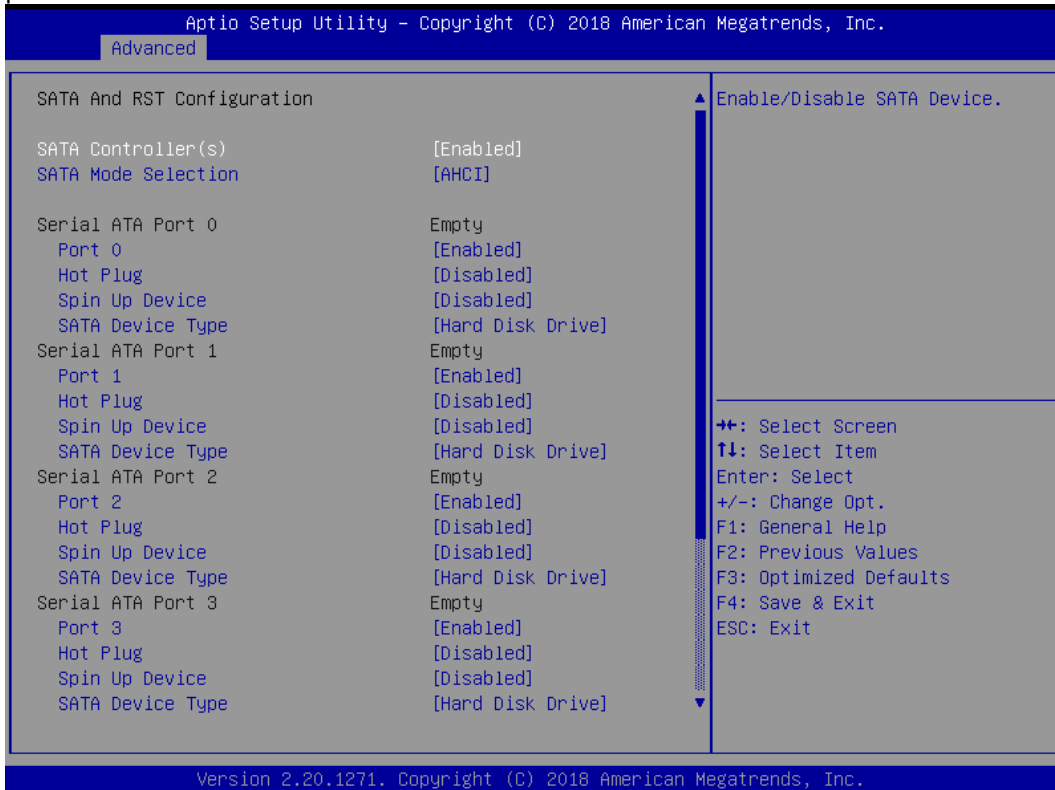

#### SATA Controller(s)

Enable or disable the SATA Controller feature. The default is Enabled.

#### SATA Mode Selection

Determine how SATA controller(s) operate. Operation mode options are RAID and AHCI (Advanced Host Controller Interface). The default is the AHCI mode.

#### SATA Controller Speed

Indicates the maximum speed the SATA controller can support.

#### Hot Plug

Designates this port as Hot Pluggable.

#### Spin Up Device

If enabled for any of ports, Staggered Spin Up will be performed and only the drives that have this option enabled will spin up at boot. Otherwise all drives spin up at boot.

#### SATA Device Type

Identify the SATA port is connected to a solid-state drive (SSD) or hard disk drive (HDD).

- **Serial Port Console Redirection**

This screen allows you to set serial port console redirection.

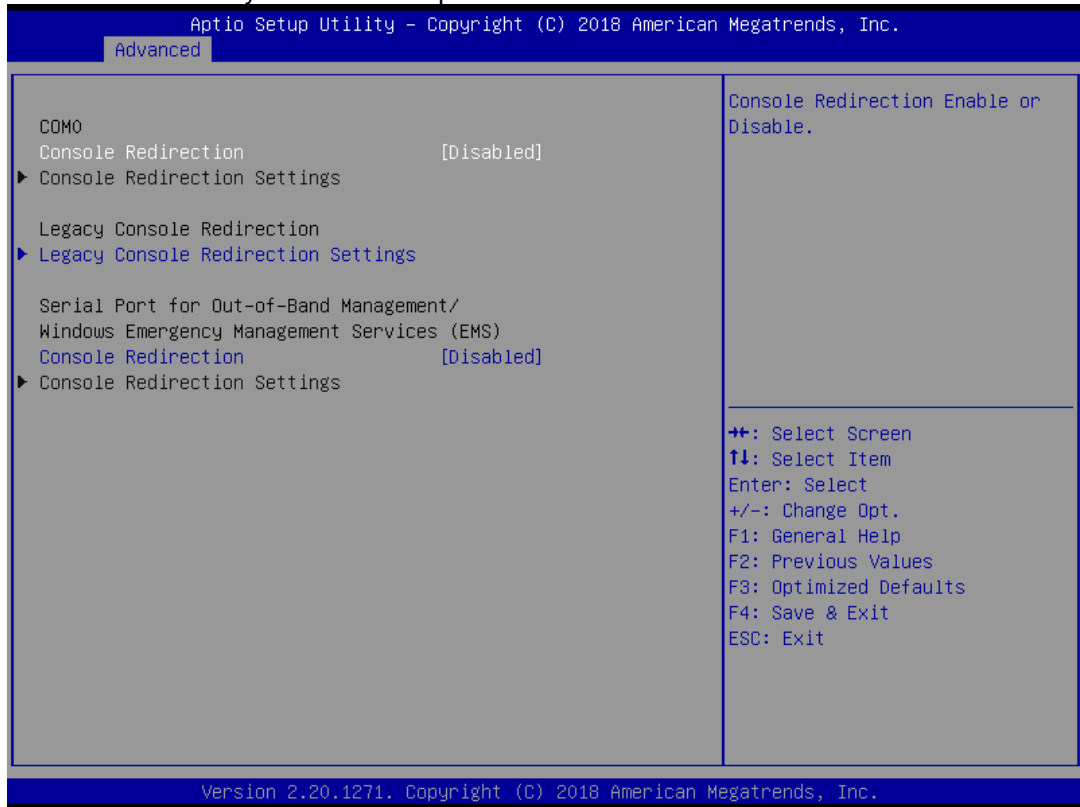

- **USB Configuration**

This screen shows USB configuration.



**USB Devices**

Displays all detected USB devices.

**Legacy USB Support**

Enables Legacy USB support. AUTO option disables legacy support if no USB devices are connected.

**XHCI Hand-off**

This is a workaround for OSES without XHCI hand-off support. The XHCI ownership change should be claimed by XHCI driver.

**USB Mass Storage Driver Support**

Enable/Disable USB Mass Storage Driver Support.

**USB transfer time-out**

The time-out value for Control, Bulk, and Interrupt transfers.

**Device reset time-out**

USB mass storage device Start Unit command time-out.

**Device power-up delay**

Maximum time the device will take before it properly reports itself to the Host Controller. 'Auto' uses default value: for a Root port it is 100 ms, for a Hub port the delay is taken from Hub descriptor.

## 4.5 Chipset Menu

The Chipset menu allows users to change the advanced chipset settings. You can select any of the items in the left frame of the screen to go to the sub menus:

- ▶ System Agent (SA) Configuration
- ▶ PCH-IO Configuration

For items marked with “▶”, please press <Enter> for more options.



- **System Agent (SA) Configuration**

This screen allows users to configure System Agent (SA) parameters. For items marked with “▶”, please press <Enter> for more options.



**Graphics Configuration**

Open the sub menu for parameters related to graphics configuration.

**Memory Configuration**

Open the sub menu for information related to system memory.

**PEG Port Configuration**

Open the sub menu for parameters related to PEG port configuration.

**VT-d**

VT-d capability.

**Above 4GB MMIO BIOS assignment**

Enable/Disable above 4GB Memory MappedIO BIOS assignment. This is enabled automatically when Aperture Size is set to 2048MB.

**PCIE SEL(Mini Card)**

Open the sub menu for parameters related to mini card.

- **Graphics Configuration**

This screen shows graphics configuration.



**Primary IGFX Boot Display**

Select the video device which will be activated during POST (Power-On Self Test). The default is Auto.

**Internal Graphics**

Keep IGFX enabled based on the setup options.

- **Memory Configuration**

This screen shows system memory information.

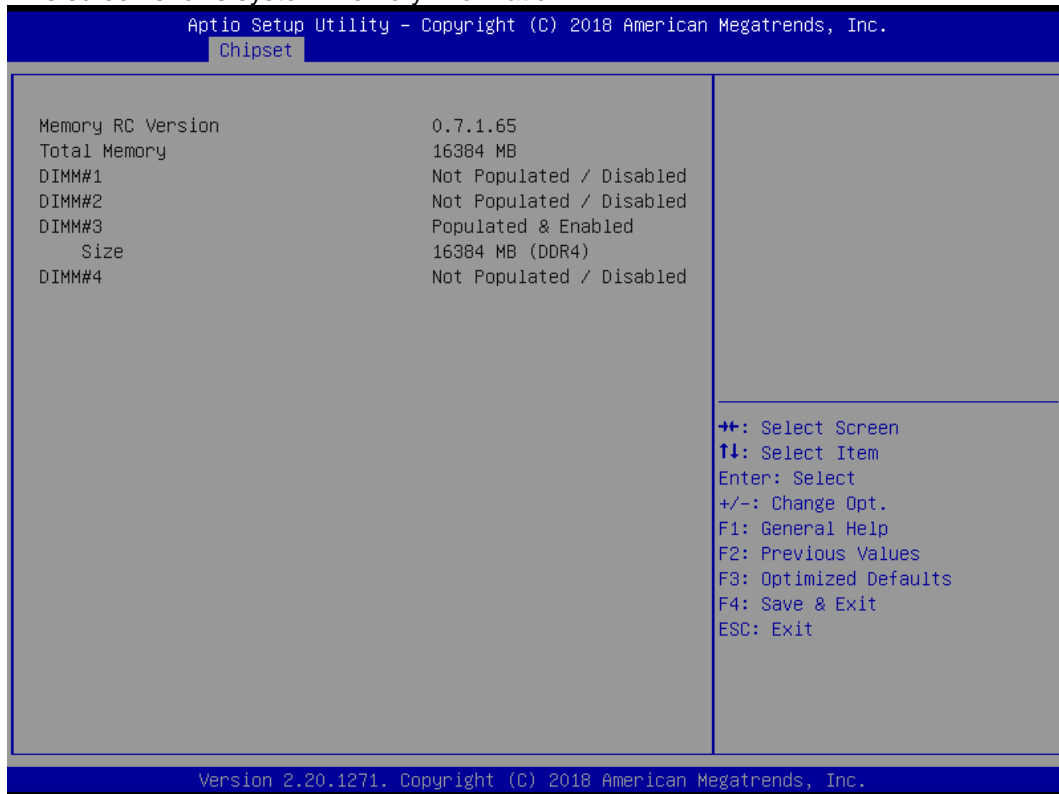

- **PEG Port Configuration**

This screen shows PEG Port/POE Port feature information.

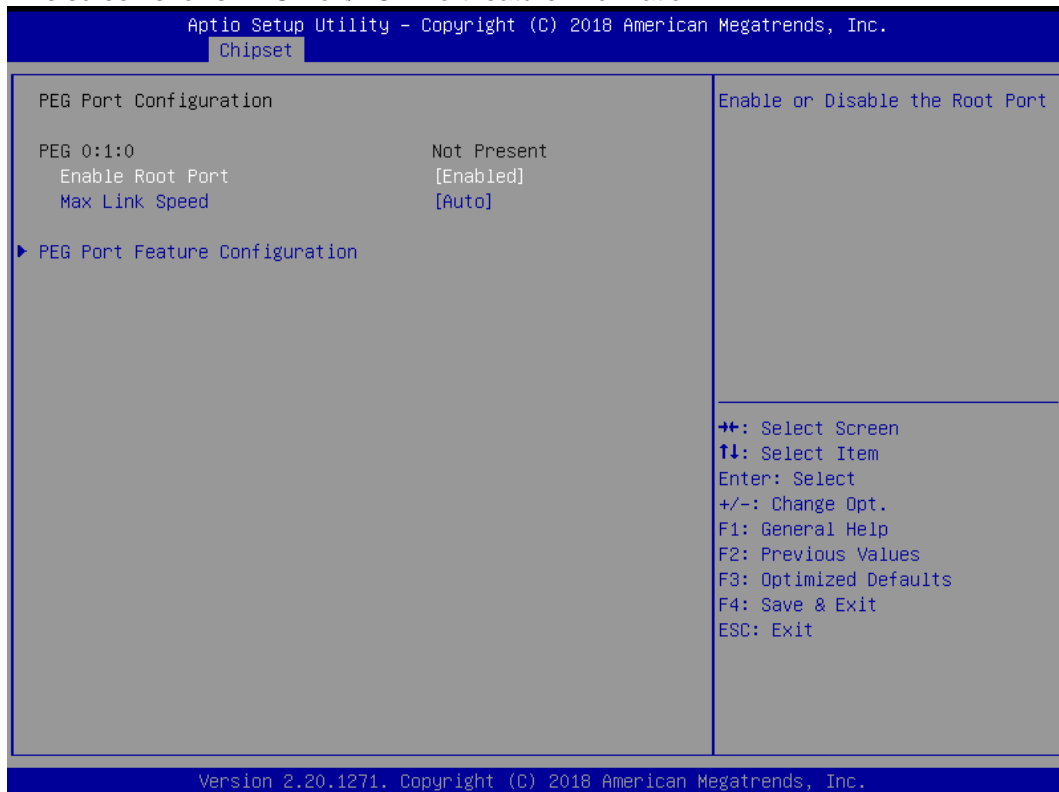



**Max Link Speed**

Configure PEG 0:1:0 Max Speed.

**PEG Port Feature Configuration**

This screen shows PEG port feature configuration.

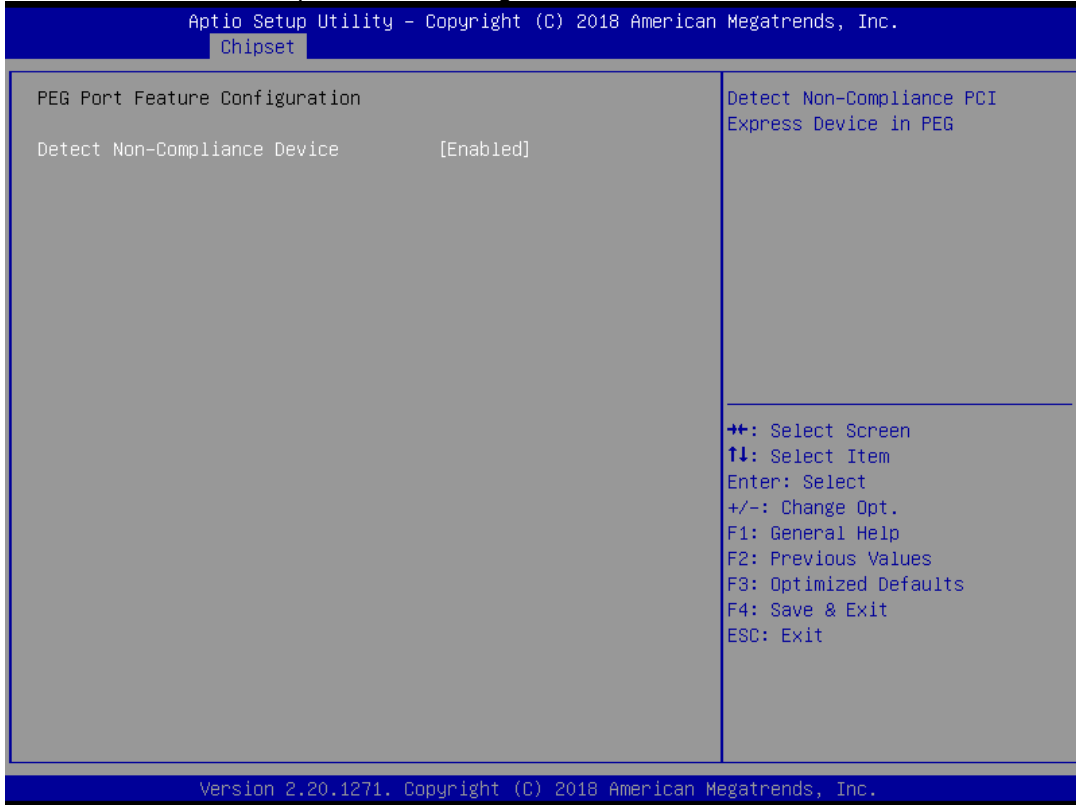

**Detect Non-Compliance Device**

Detect Non-Compliance PCI Express Device in PEG.

- **PCH-IO Configuration**

This screen allows you to set PCH parameters.



**PCH LAN Controller**

Enable or disable onboard PCH LAN controller.

**Wake on LAN Enable**

Enable or disable integrated LAN to wake the system.

- **USB Configuration**

This screen shows USB configuration.



**XHCI Disable Compliance Mode**

Provides options to disable Compliance Mode. Default is FALSE to not disable Compliance Mode. Set TRUE to disable Compliance Mode.

● **PCI Express Configuration**

This screen shows PCI Express configuration.



**Note**

**PCIE 1 -> CN 13**  
**PCIE 21-> CN 12**

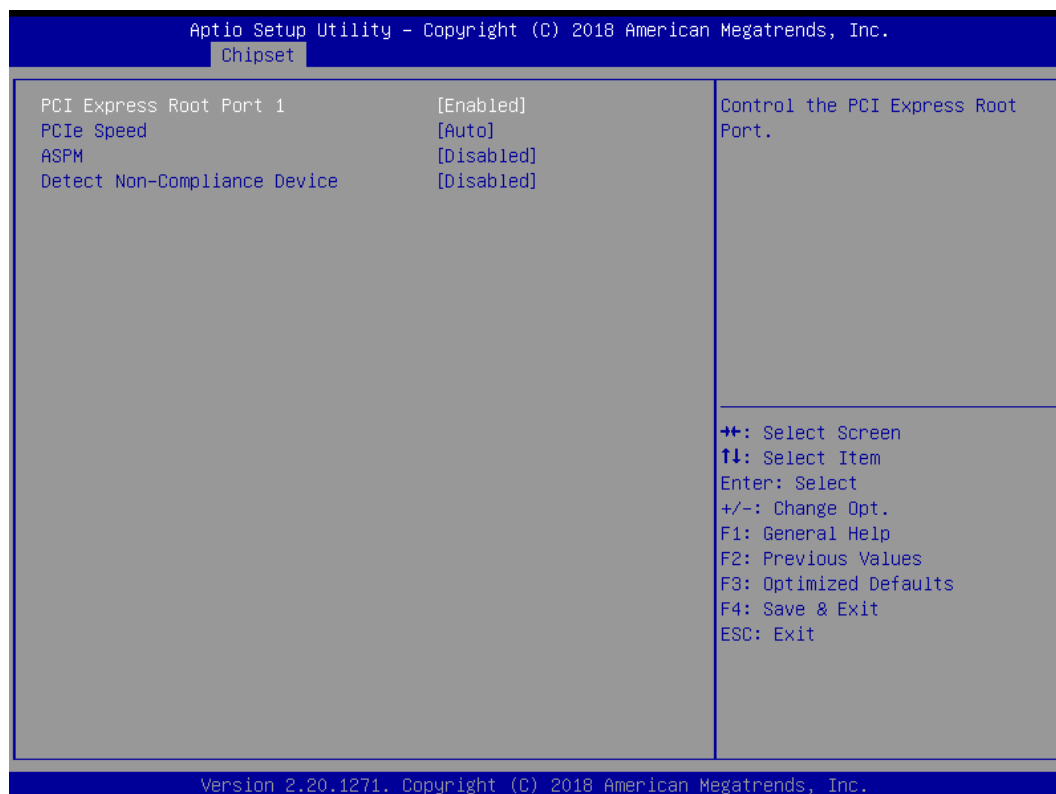

**PCIe Speed**

Configure PCIe Speed.

**ASPM**

Set the ASPM Level:\nForce L0s - Force all links to L0s State\nAUTO - BIOS auto configure\nDISABLE - Disables ASPM.

**Detect Non-Compliance Device**

Detect Non-Compliance PCI Express Device. If enabled, it will take more time at POST time.

- **HD Audio Configuration**

This screen shows HD Audio information

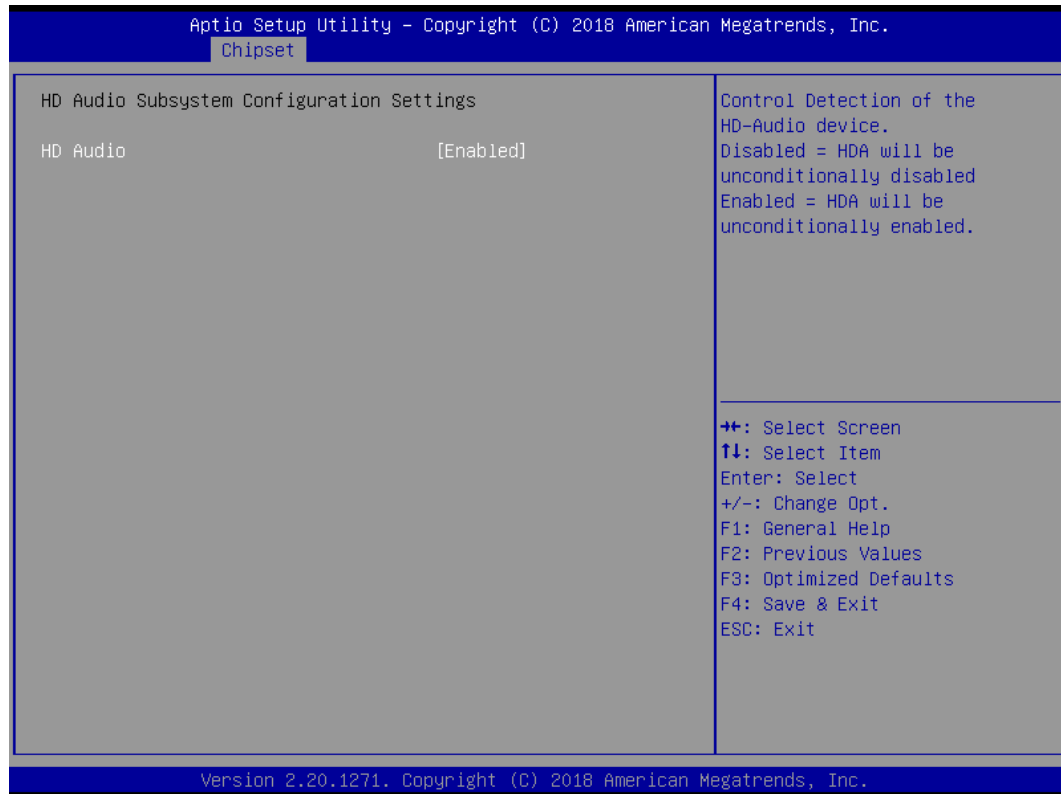

## 4.6 Security Menu

The Security menu allows users to change the security settings for the system.

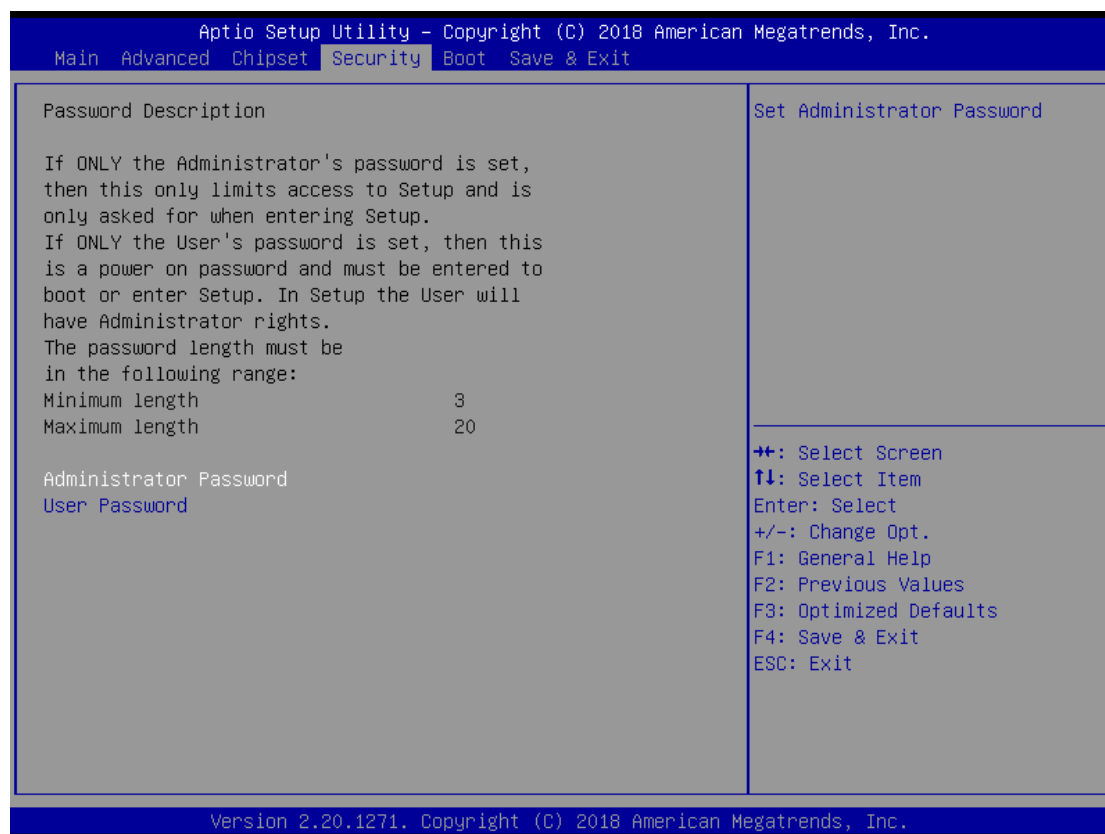

- Administrator Password**  
 This item indicates whether an administrator password has been set (installed or uninstalled).
- User Password**  
 This item indicates whether a user password has been set (installed or uninstalled).

## 4.7 Boot Menu

The Boot menu allows users to change boot options of the system.



- Setup Prompt Timeout**  
 Number of seconds to wait for setup activation key. 65535(0xFFFF) means indefinite waiting.
- Bootup NumLock State**  
 Use this item to select the power-on state for the keyboard NumLock.
- Quiet Boot**  
 Select to display either POST output messages or a splash screen during boot-up.
- Launch PXE OpROM policy**  
 Use this item to enable or disable the boot ROM function of the onboard LAN chip when the system boots up.
- Boot Option Priorities**  
 These are settings for boot priority. Specify the boot device priority sequence from the available devices.

## 4.8 Save & Exit Menu

The Save & Exit menu allows users to load your system configuration with optimal or fail-safe default values.

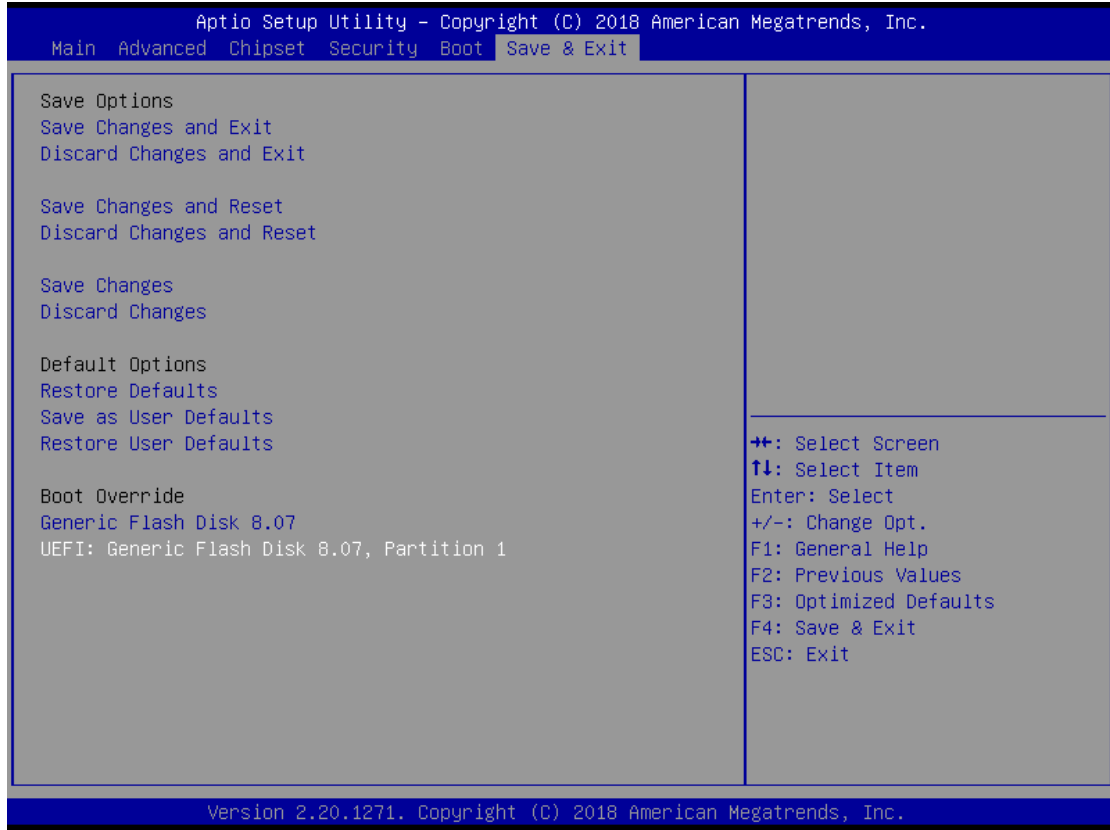

- Save Changes and Exit**  
When you have completed the system configuration changes, select this option to leave Setup and return to Main Menu. Select Save Changes and Exit from the Save & Exit menu and press <Enter>. Select Yes to save changes and exit.
- Discard Changes and Exit**  
Select this option to quit Setup without making any permanent changes to the system configuration and return to Main Menu. Select Discard Changes and Exit from the Save & Exit menu and press <Enter>. Select Yes to discard changes and exit.
- Save Changes and Reset**  
When you have completed the system configuration changes, select this option to leave Setup and reboot the computer so the new system configuration parameters can take effect. Select Save Changes and Reset from the Save & Exit menu and press <Enter>. Select Yes to save changes and reset.
- Discard Changes and Reset**  
Select this option to quit Setup without making any permanent changes to the system configuration and reboot the computer. Select Discard Changes and Reset from the Save & Exit menu and press <Enter>. Select Yes to discard changes and reset.



- **Save Changes**  
When you have completed the system configuration changes, select this option to save changes. Select Save Changes from the Save & Exit menu and press <Enter>. Select Yes to save changes.
- **Discard Changes**  
Select this option to quit Setup without making any permanent changes to the system configuration. Select Discard Changes from the Save & Exit menu and press <Enter>. Select Yes to discard changes.
- **Restore Defaults**  
It automatically sets all Setup options to a complete set of default settings when you select this option. Select Restore Defaults from the Save & Exit menu and press <Enter>.
- **Save as User Defaults**  
Select this option to save system configuration changes done so far as User Defaults. Select Save as User Defaults from the Save & Exit menu and press <Enter>.
- **Restore User Defaults**  
It automatically sets all Setup options to a complete set of User Defaults when you select this option. Select Restore User Defaults from the Save & Exit menu and press <Enter>.
- **Boot Override**  
Select a drive to immediately boot that device regardless of the current boot order.

**This page is intentionally left blank.**

# Appendix A

## Watchdog Timer

### About Watchdog Timer

Software stability is a major issue in most applications. Some embedded systems are not watched by humans for 24 hours. It is usually too slow to wait for someone to reboot when computer hangs. The systems need to be able to reset automatically when things go wrong. The watchdog timer gives us that solution.

The watchdog timer is a counter that triggers a system reset when it counts down to zero from a preset value. The software starts the counter with an initial value and must reset it periodically. If the counter ever reaches zero which means the software has crashed, the system will reboot.

### How to Use Watchdog Timer

Start

↓

Un-Lock WDT:

O 2E 87 ; Un-lock super I/O  
O 2E 87 ; Un-lock super I/O

↓

Select Logic device:

O 2E 07  
O 2F 08

↓

Set Second or Minute:

O 2E F0  
O 2F N ; N=00 or 08 (See  Note below)

↓

Set base timer:

O 2E F1  
O 2F M ; M=00,01,02,...FF(Hex) ,Value=0 to 255

↓

WDT counting re-set timer:

O 2E F1  
O 2F M ; M=00,01,02,...FF (See  Note below)

↓

IF No re-set timer:

; WDT time-out, generate RESET

;IF to disable WDT:

O 2E 30  
O 2F 00 ; Can be disabled at any time

- Timeout Value Range
  - 1 to 255
  - Minute / Second

 **Note:**

If **N=00h**, the time base is set to second.

**M** = time value

00h: Time-out Disable

01h: Time-out occurs after 1 second

02h: Time-out occurs after 2 seconds

03h: Time-out occurs after 3 seconds

.

FFh: Time-out occurs after 255 seconds

If **N=08h**, the time base is set to minute.

**M** = time value

00h: Time-out Disable

01h: Time-out occurs after 1 minute

02h: Time-out occurs after 2 minutes

03h: Time-out occurs after 3 minutes

.

FFh: Time-out occurs after 255 minutes

# Appendix B

## TPM Module Installation

The TPM 2.0 (Trusted Platform Module 2.0) module is a modularized design applying to the IMB523R / 524R / 525R and provides enhanced hardware security for the computer. In this appendix you will learn how to install the TPM 2.0 module into the IMB523R / 524R / 525R. Please read and follow the instructions below carefully.

1. Insert TPM module into the SPI interface of motherboard, as illustrated below.

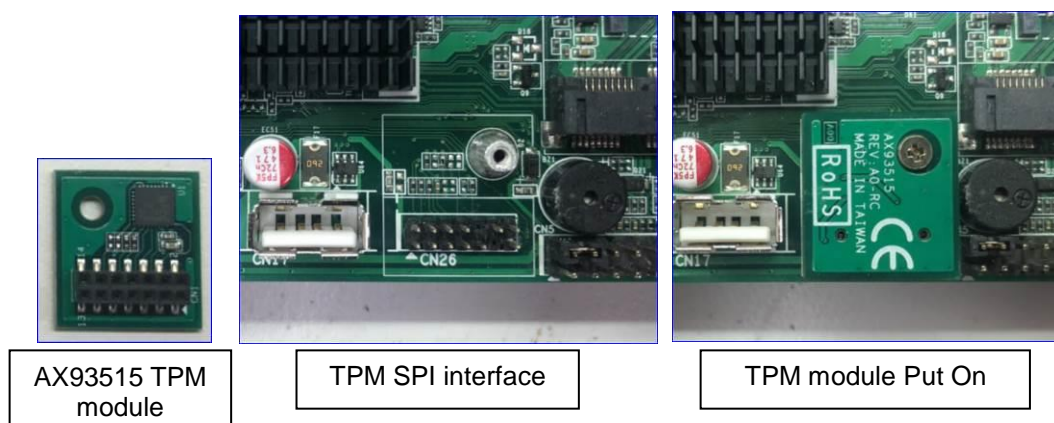

2. There are two ways to confirm whether the TPM Module is installed successfully or not:
  - a. Enter the BIOS setup menu and go to Trusted Computing. On the first line will show "TPM2.0 Device Found".

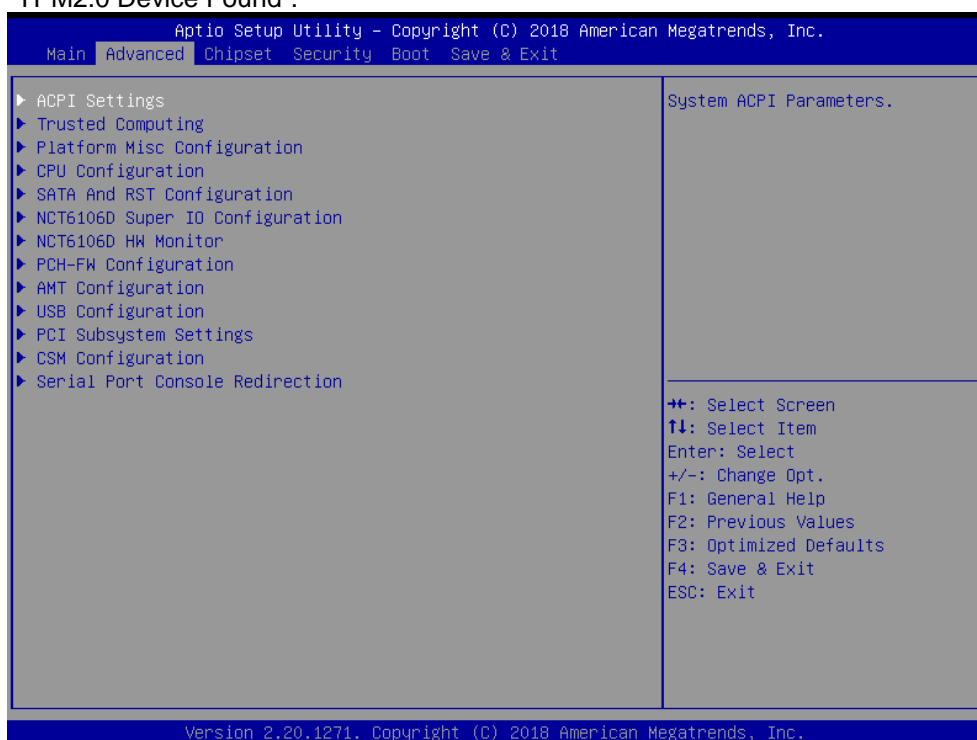

(In the Advance menu, go to Trusted Computing)



(In the Trusted Computing section, on the first of line will show "TPM2.0 Device Found", if installation is successful.)

- b. In the Windows 10 OS environment, enter Device Manager, and select the item of Security devices. The screen will show "Trusted Platform Module 2.0" if installation is successful.

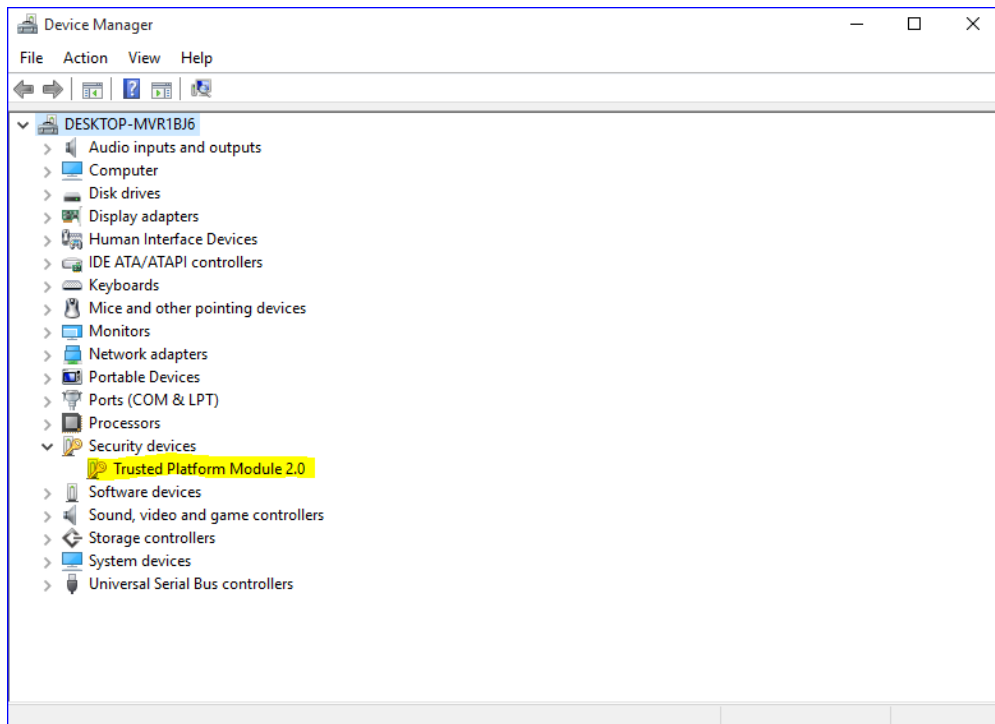

- c. In the Windows 10 OS environment, enter Control Panel, select the item of BitLocker Drive Encryption, and enter TPM Administration. The screen will show the information below if installation is successful.

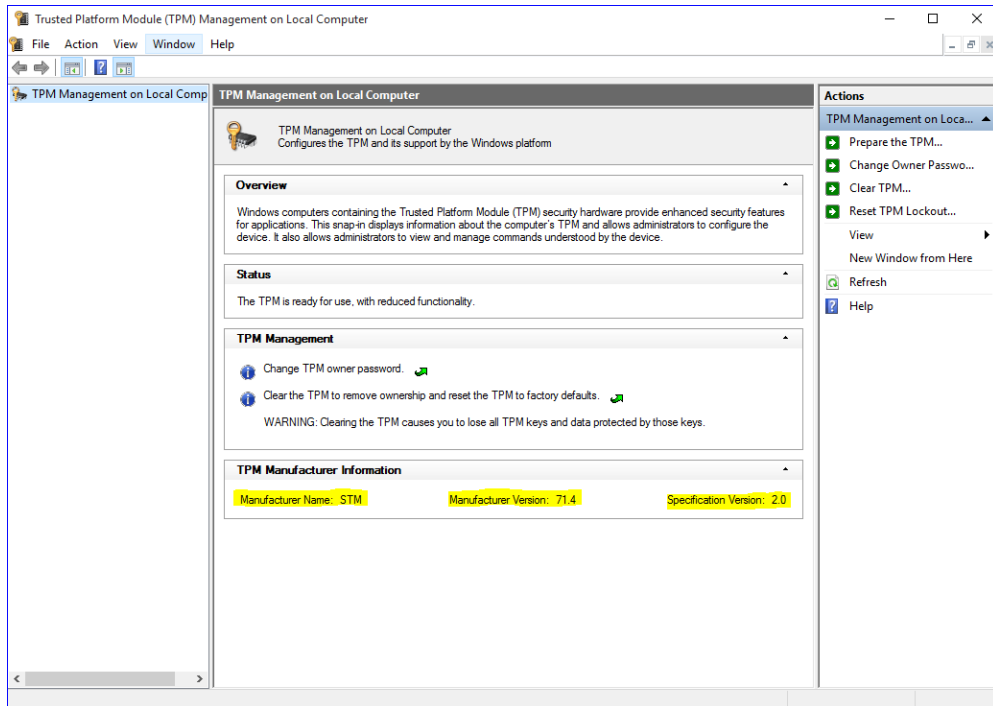

**This page is intentionally left blank.**



# Appendix C

## iAMT Settings

The Intel® Active Management Technology (Intel® AMT) utilizes built-in platform capabilities and popular third-party management and security applications to let IT administrators remotely discover, repair and better protect their networked computing assets, thus significantly improving IT management efficiency.

In order to use Intel® AMT you must enter the ME BIOS (<Ctrl + P> during system startup), change the ME BIOS password, and then select “Intel® iAMT” as the manageability feature.

### Entering Management Engine BIOS Extension (MEBx)

1. Go to BIOS to enable the iAMT function.
2. Exit from BIOS after starting iAMT, and press <Ctrl + P> to enter MEBx Setting.



**Note:** It is advised to press <Ctrl + P> before the screen pops out.

### Set and Change Password

1. You will be asked to set a password at first login. The default password is “admin”.

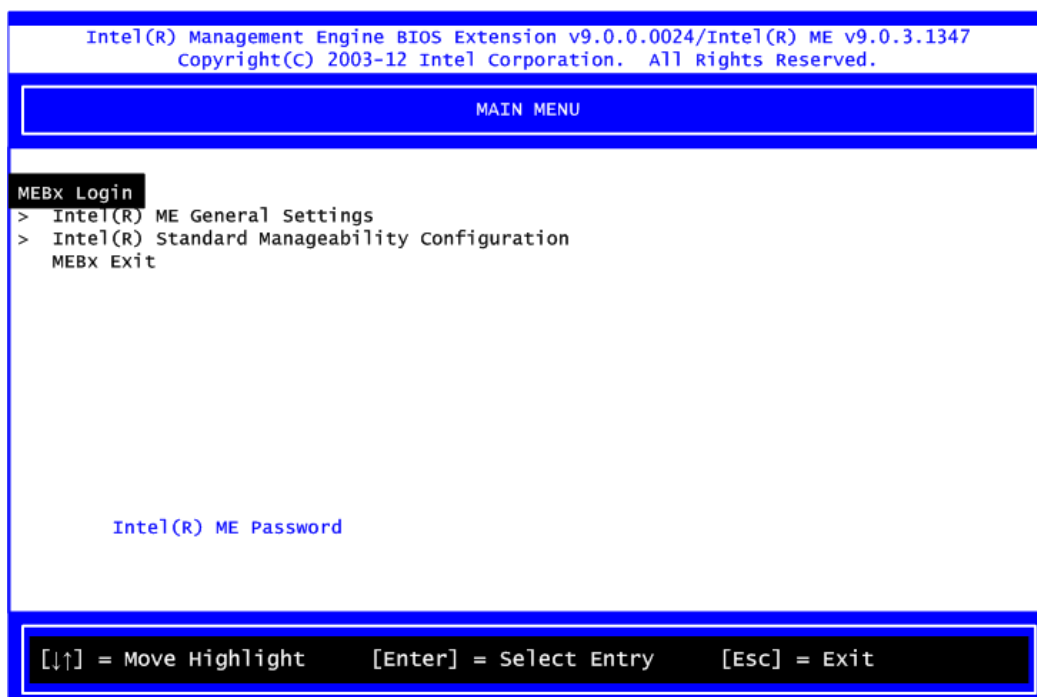

2. You will be asked to change the password before setting ME.

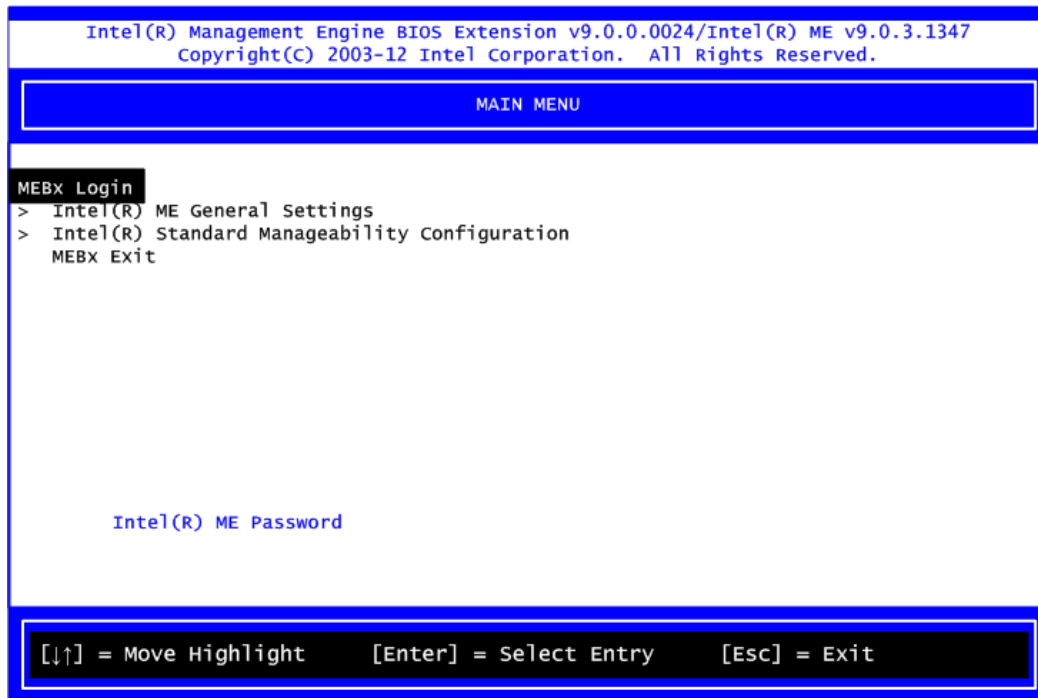

3. Confirm your new password while revising. The new password must consist of eight characters, including at least:

- One upper case letter
- One lower case letter
- One number
- One special symbol, such as '!', '\$', ';' (except: ':', ',', '"') )

The default value demonstrates an example of a valid password: **!!11qqQQ**

Underline ( \_ ) and space are valid characters for the password, but they won't make higher complexity.

## iAMT Settings

1. Select Intel® AMT configuration and press <Enter>.

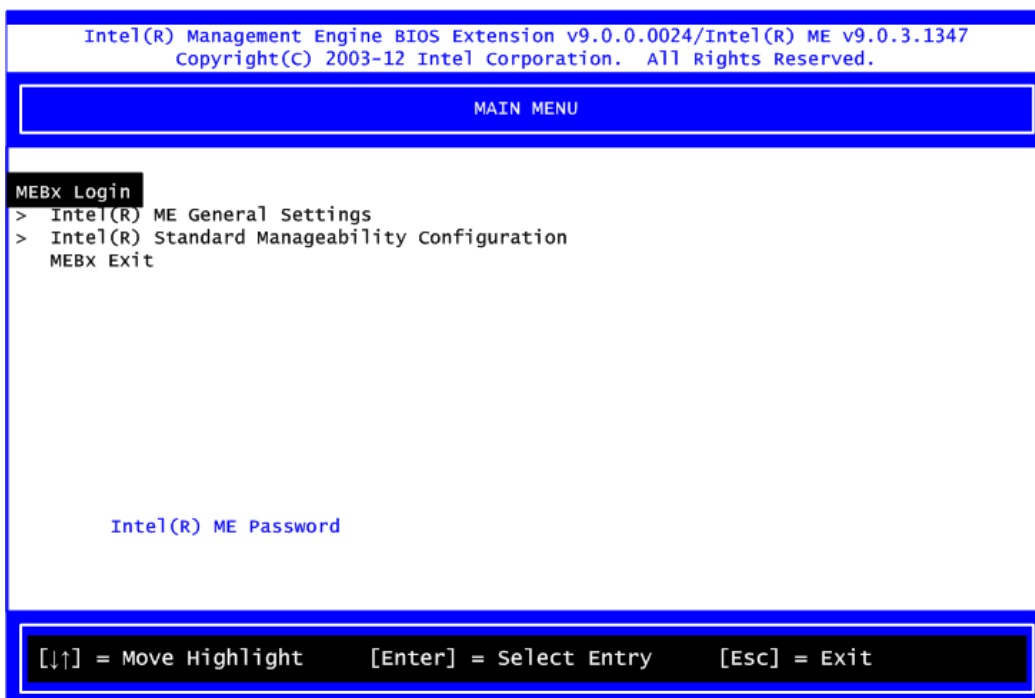

2. Select Network Setup to configure iAMT.

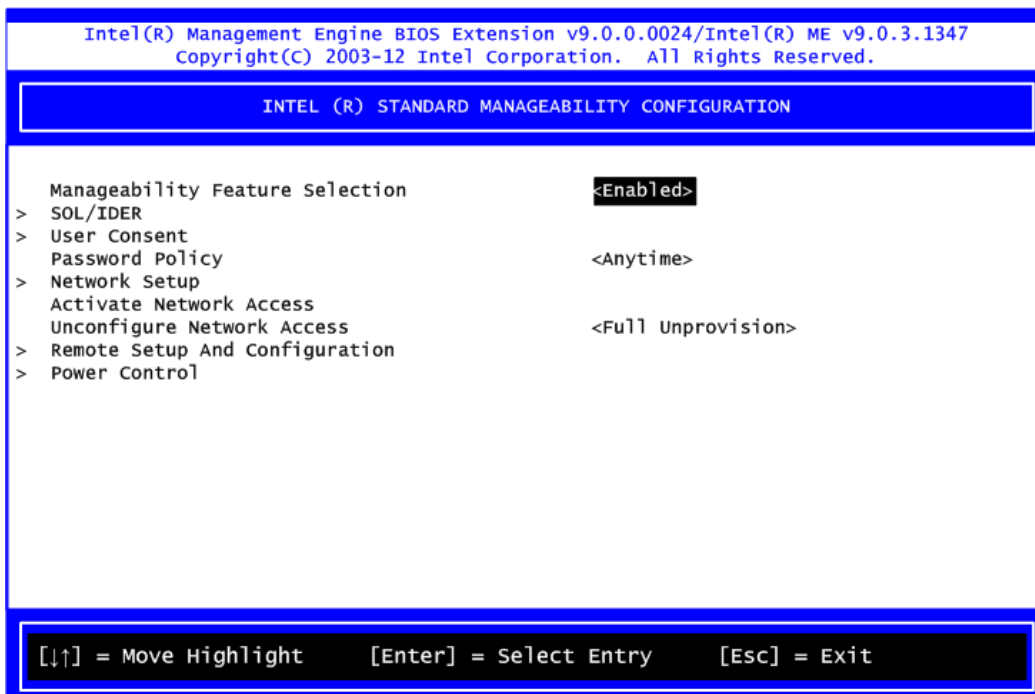

3. Select TCP/IP to go into Network interface and set it to Enabled. Go into DHCP Mode and set it to Disabled.

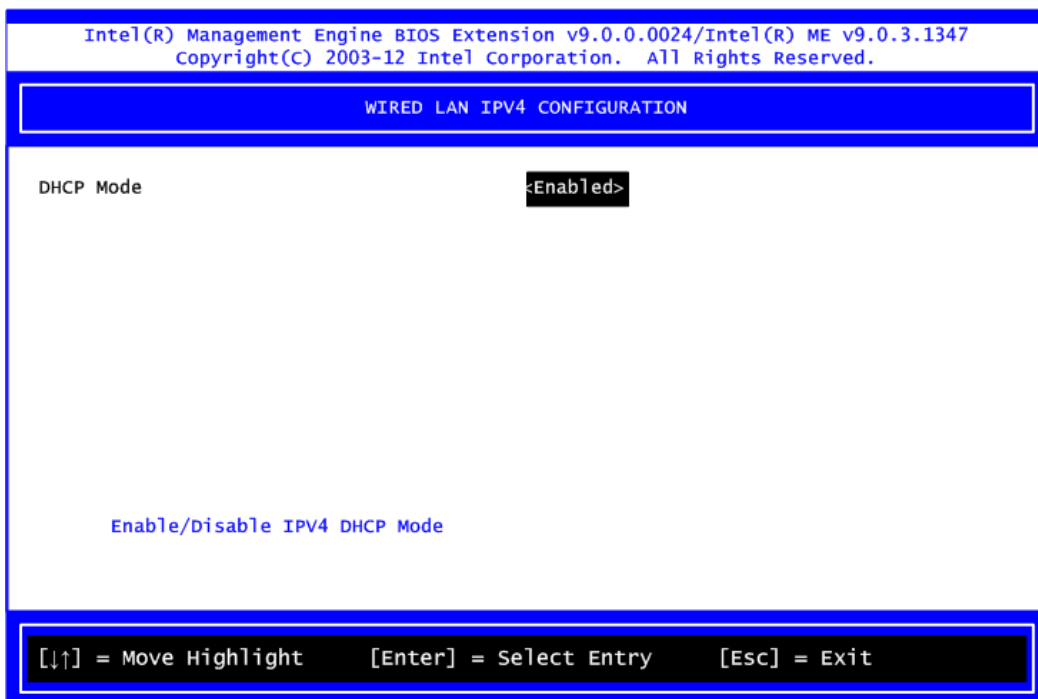
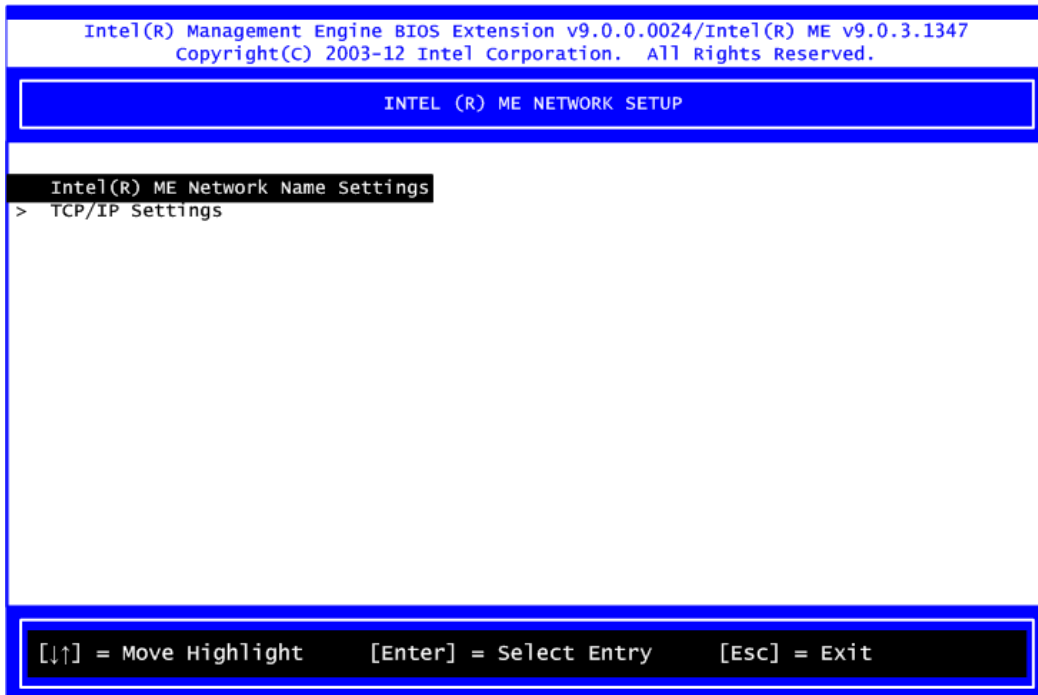

4. If DHCP Mode is disabled, complete the following settings:

- IP address
- Subnet mask

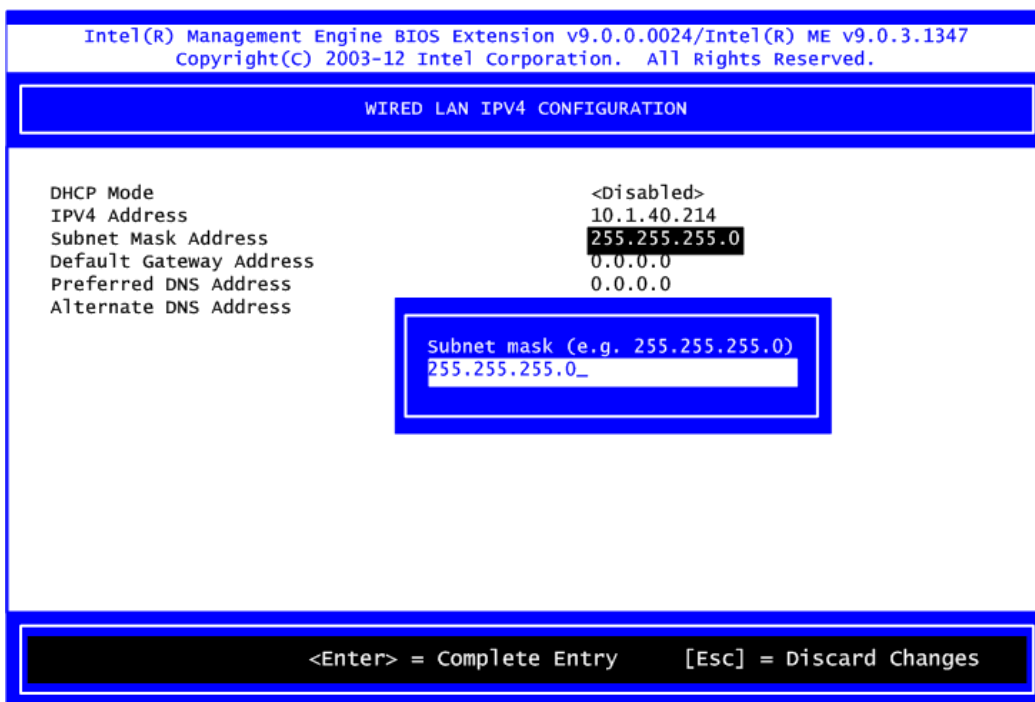

5. Go back to Intel® AMT Configuration, then select Activate Network Access and press <Enter>.

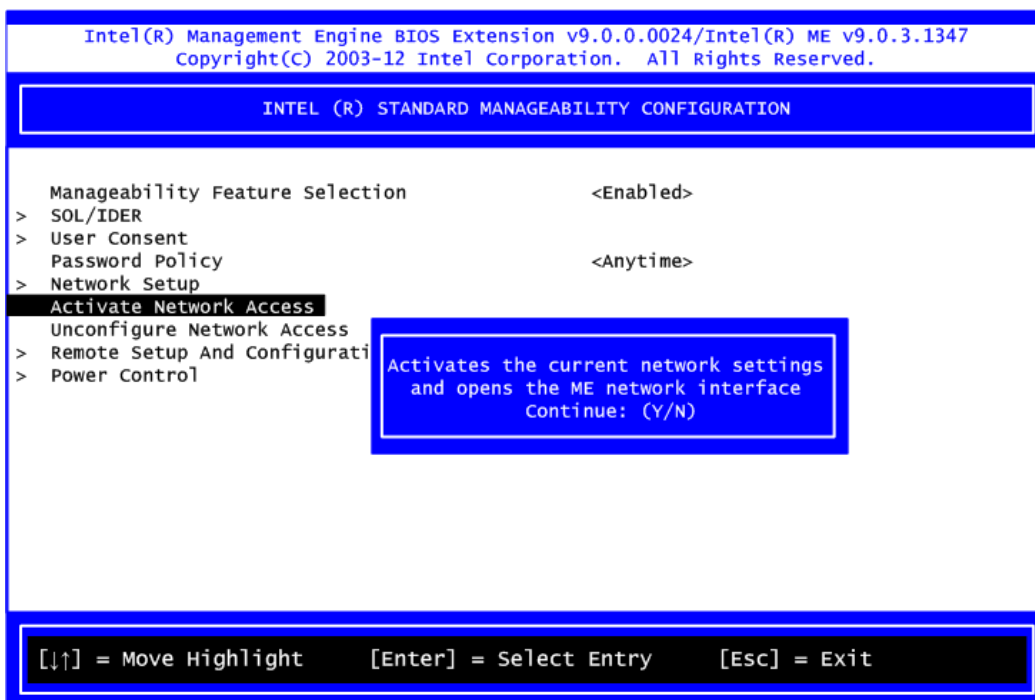

6. Exit from MEBx after completing the iAMT settings.

## iAMT Web Console

1. On a web browser, type [http://\(IP ADDRESS\):16992](http://(IP ADDRESS):16992), which connects to iAMT Web.

Example: <http://10.1.40.214:16992>

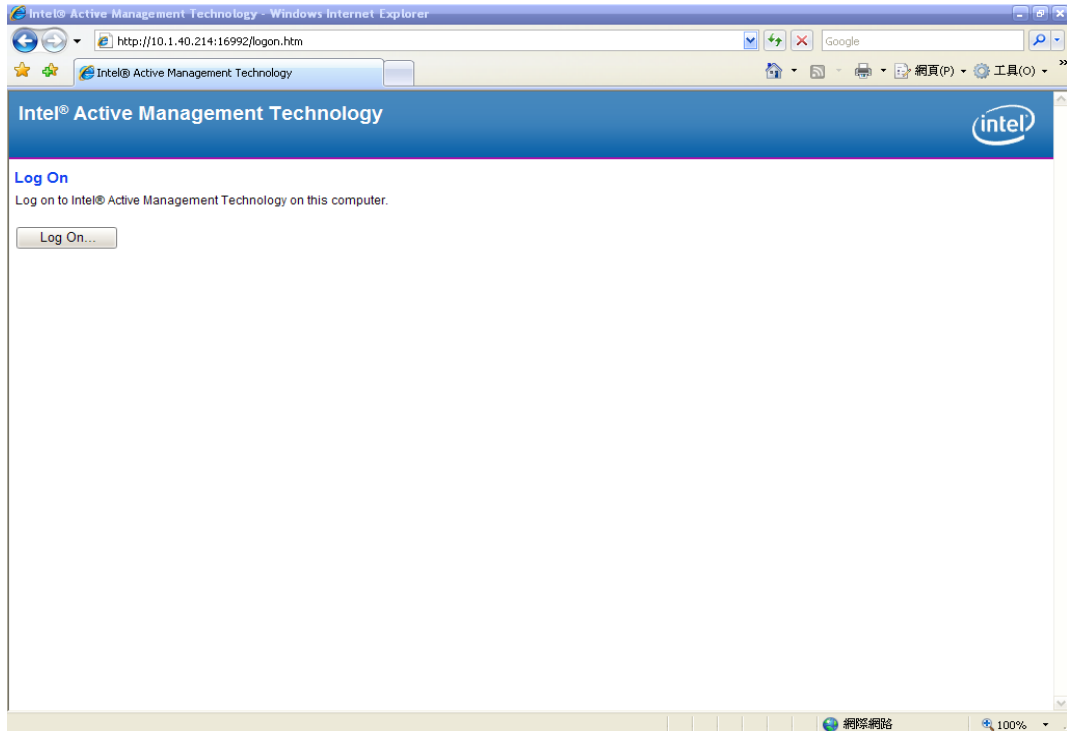

2. To log on, you will be required to type in your username and password for access to the Web.

USER: admin (default value)

PASS: (MEBx password)

3. Enter the iAMT Web.

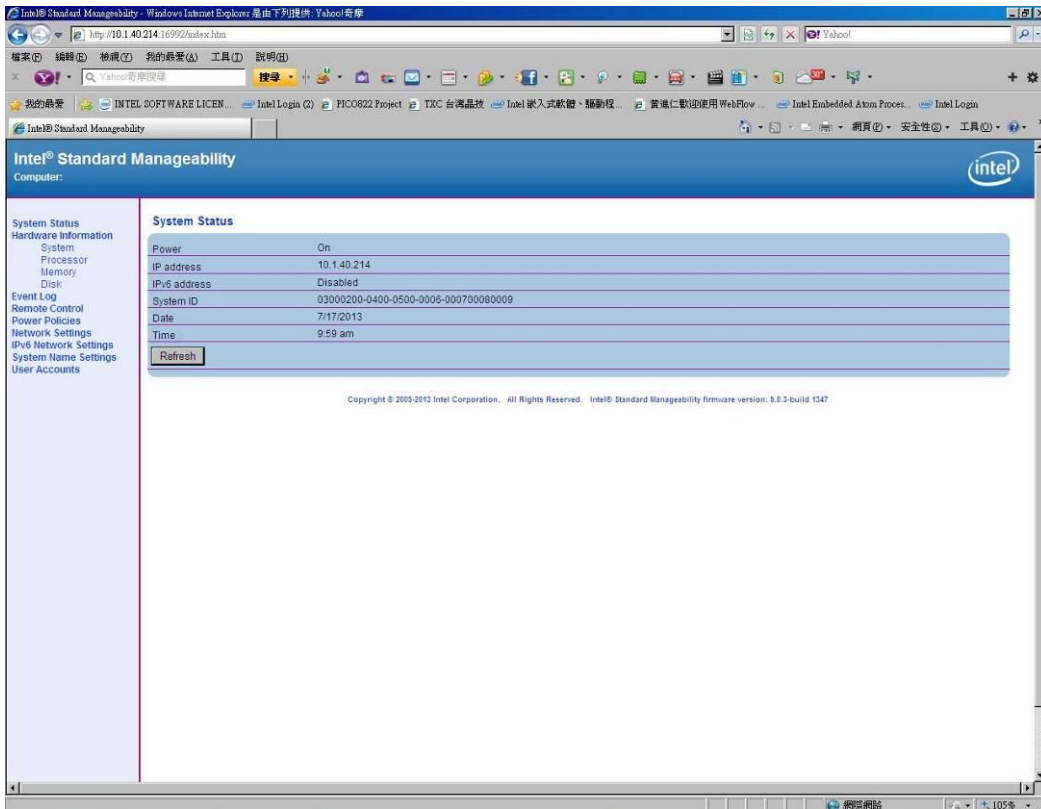

4. Click Remote Control, and select commands on the right side.

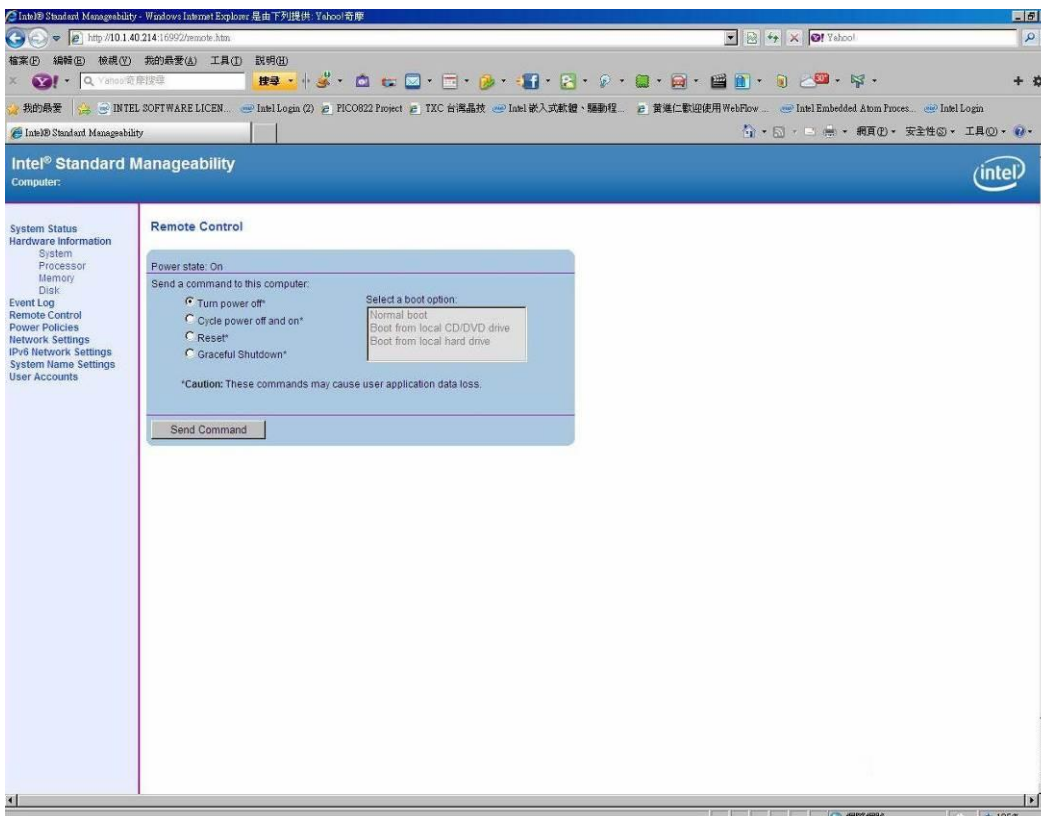

5. When you have finished using the iAMT Web console, close the Web browser.



# Appendix D

## Configuring SATA for RAID

### Configuring SATA Hard Drive(s) for RAID Function

Before you begin the SATA configuration, please prepare:

- Two SATA hard drives (to ensure optimal performance, it is recommended that you use two hard drives with identical model and capacity). If you do not want to create RAID with the SATA controller, you may prepare only one hard drive.

**Please follow up the steps below to configure SATA hard drive(s):**

1. Install SATA hard drive(s) in your system.
2. Enter the BIOS Setup to configure SATA controller mode and boot sequence.
3. Configure RAID by the RAID BIOS.

#### **1. Installing SATA hard drive(s) in your system.**

Connect one end of the SATA signal cable to the rear of the SATA hard drive, and the other end to available SATA port(s) on the board. Then, connect the power connector of power supply to the hard drive.

#### **2. Configuring SATA controller mode and boot sequence by the BIOS Setup.**

You have to make sure whether the SATA controller is configured correctly by system BIOS Setup and set up BIOS boot sequence for the SATA hard drive(s).

- Turn on your system, and then press the <Del> button to enter BIOS Setup during running POST (Power-On Self Test). If you want to create RAID, just go to the Advanced Settings menu/SATA Configuration, select the "SATA Mode Selection", and press <Enter> for more options.

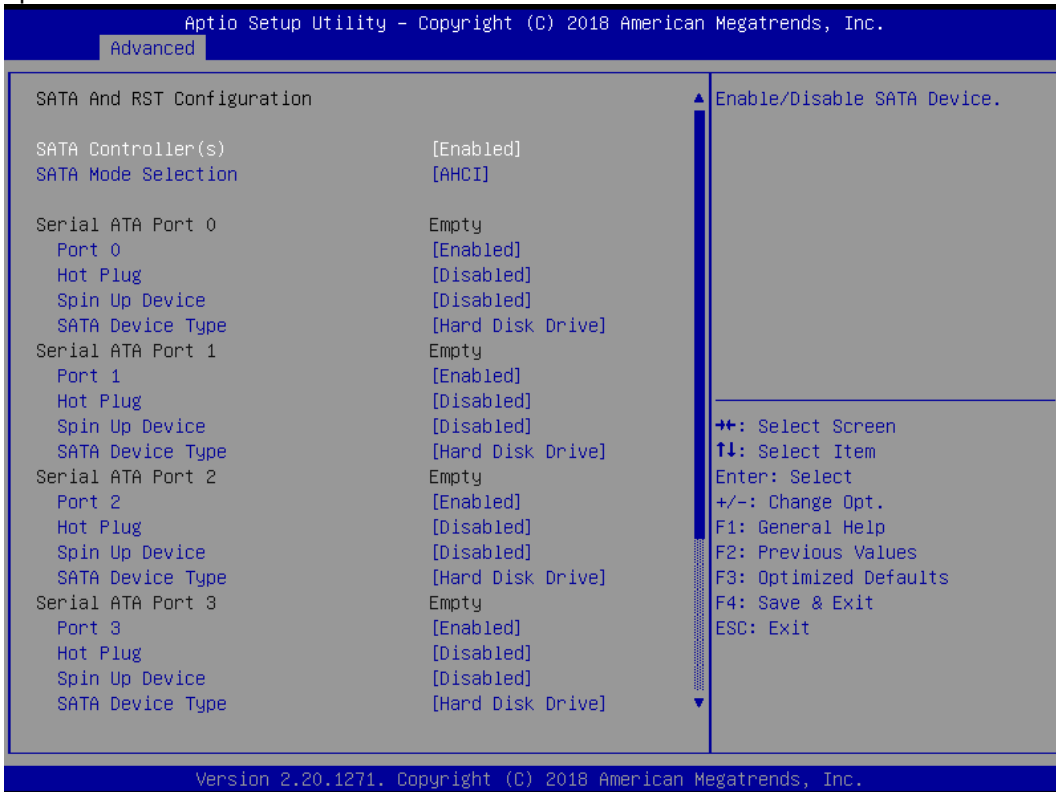

A list of options appears, please select "RAID".

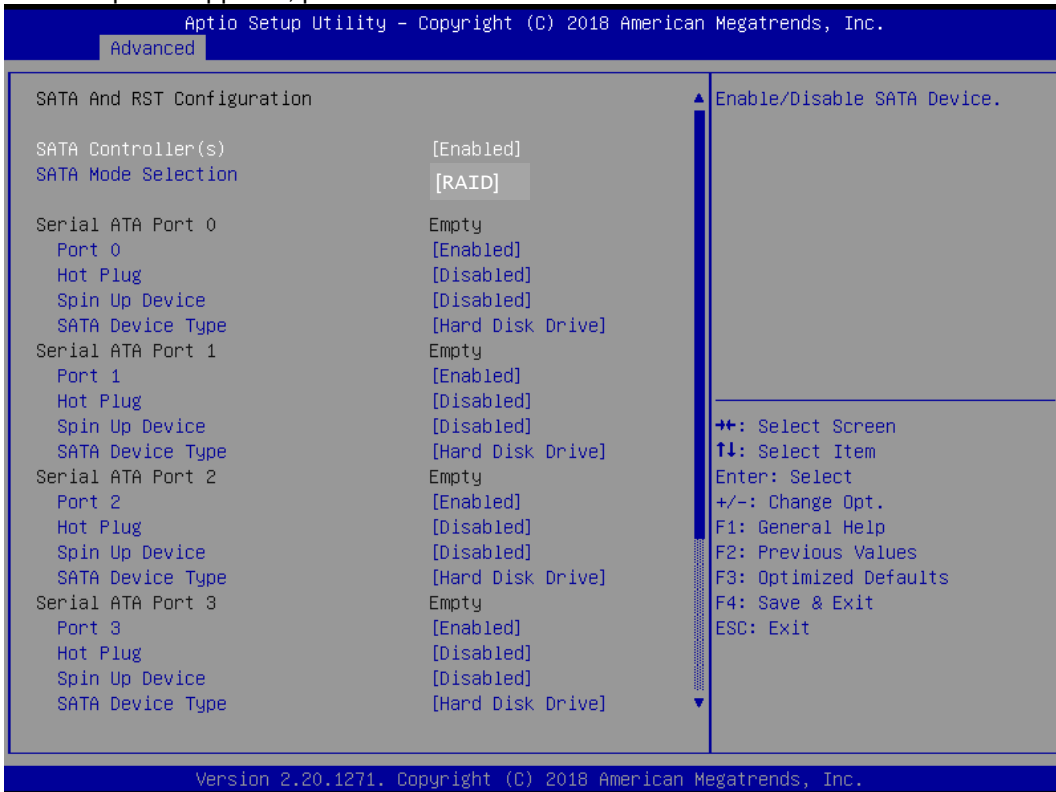

- 2.2. Under the Boot Settings menu, set DVD-ROM for First Boot Option to boot DVD-ROM after system restarts.

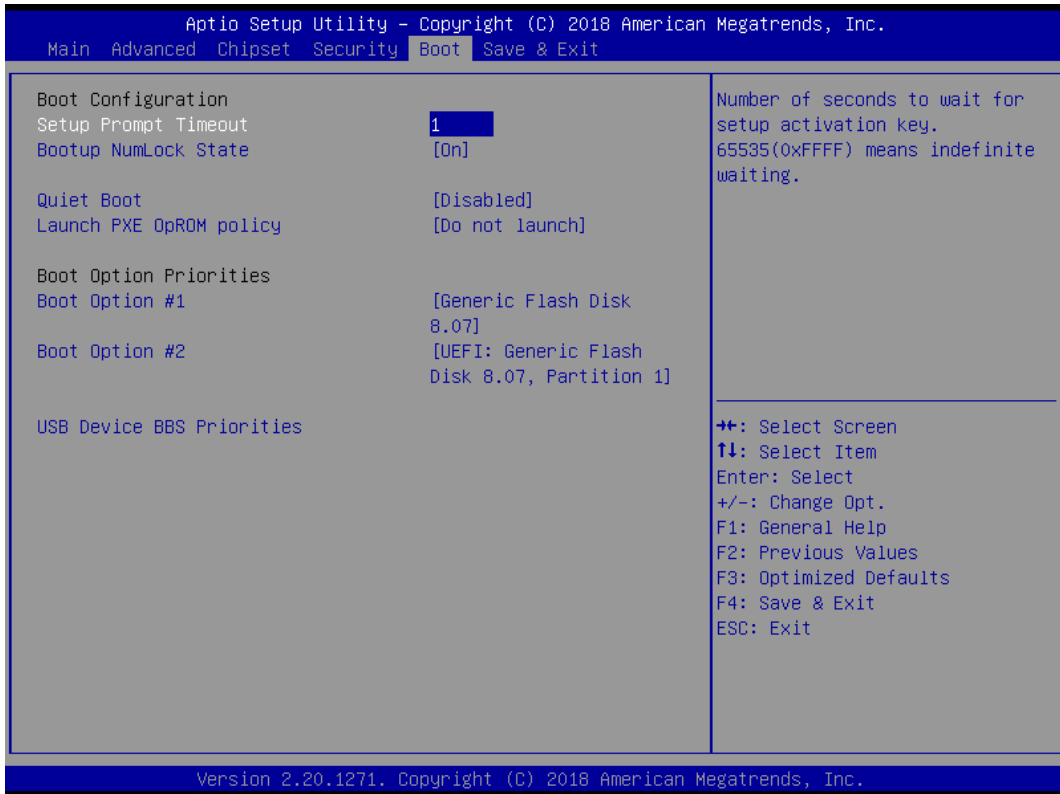

- 2.3. Save and exit the BIOS Setup.

### 3. Configuring RAID by the RAID BIOS.

Enter the RAID BIOS setup utility to configure a RAID array. Skip this step and proceed if you do not want to create a RAID.

- 3.1. After the POST memory testing and before the operating system booting, a message “Press <Ctrl - I> to enter Configuration Utility” shows up. Accordingly, press <Ctrl - I> to enter the RAID BIOS setup utility.

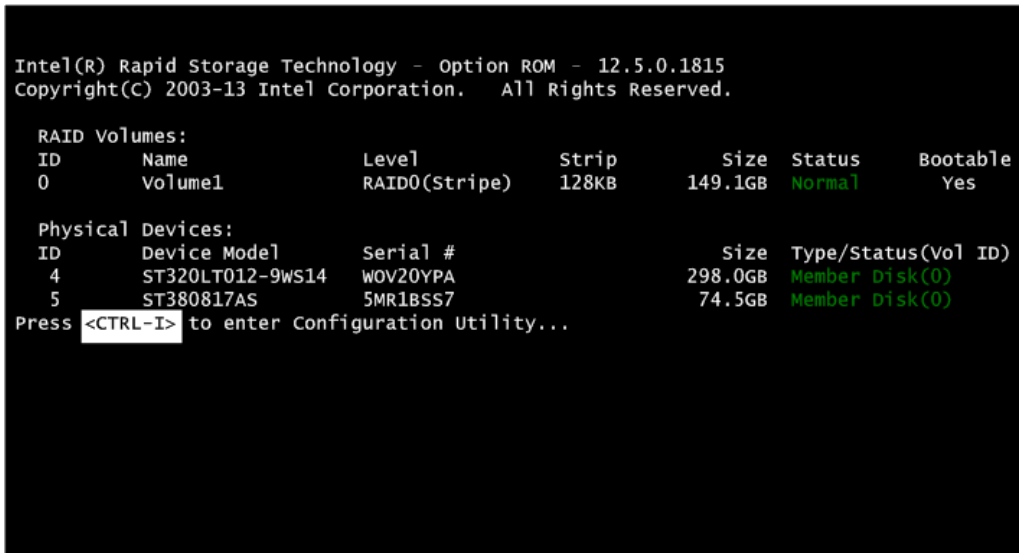

- 3.2. After you press <Ctrl - I>, the “Create RAID Volume” screen will appear. If you want to create a RAID array, select the “Create RAID Volume” option in the Main Menu and press <Enter>.

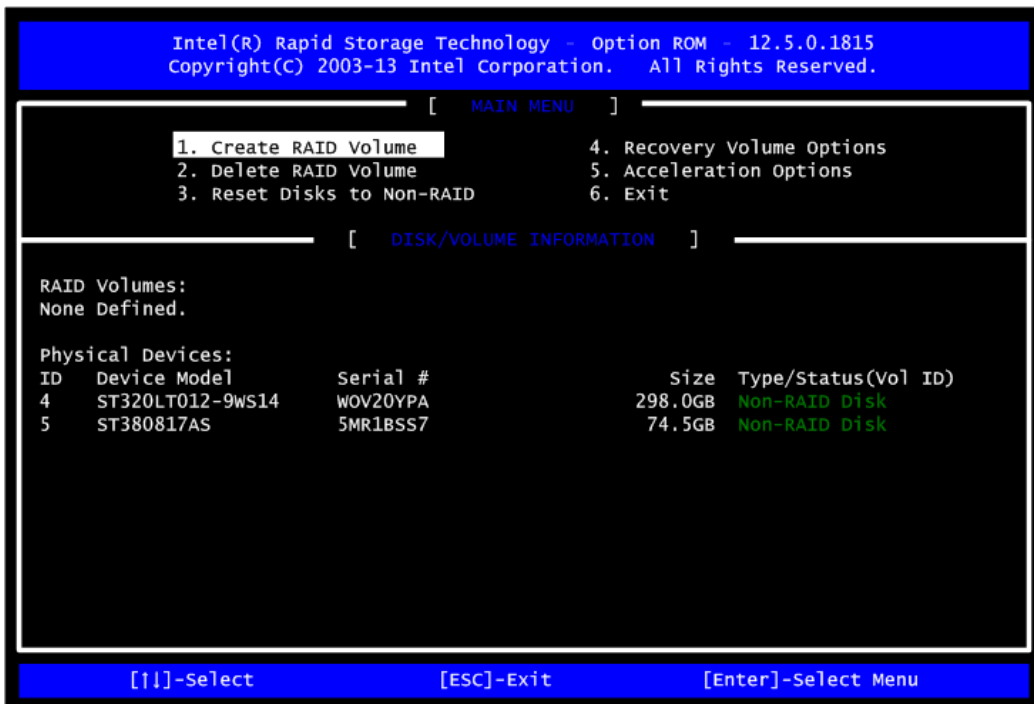

- 3.3. After entering the “Create Volume Menu” screen, you can type the disk array name with 1~16 letters (letters cannot be special characters) in the item “Name”.



- 3.4. When finished, press <Enter> to select a RAID level. There are four RAID levels: RAID0, RAID1, RAID5 and RAID10. Select a RAID level and press <Enter>.

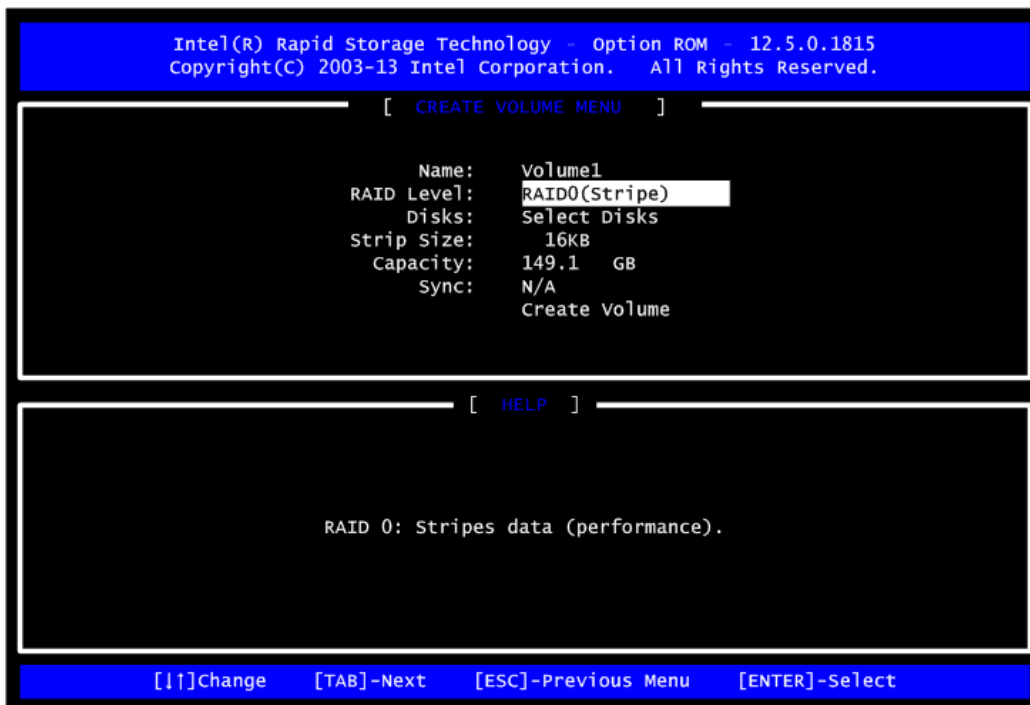

- 3.5. Set the stripe block size. The KB is the standard unit of stripe block size. The stripe block size can be 4KB to 128KB. After the setting, press <Enter> for the array capacity.

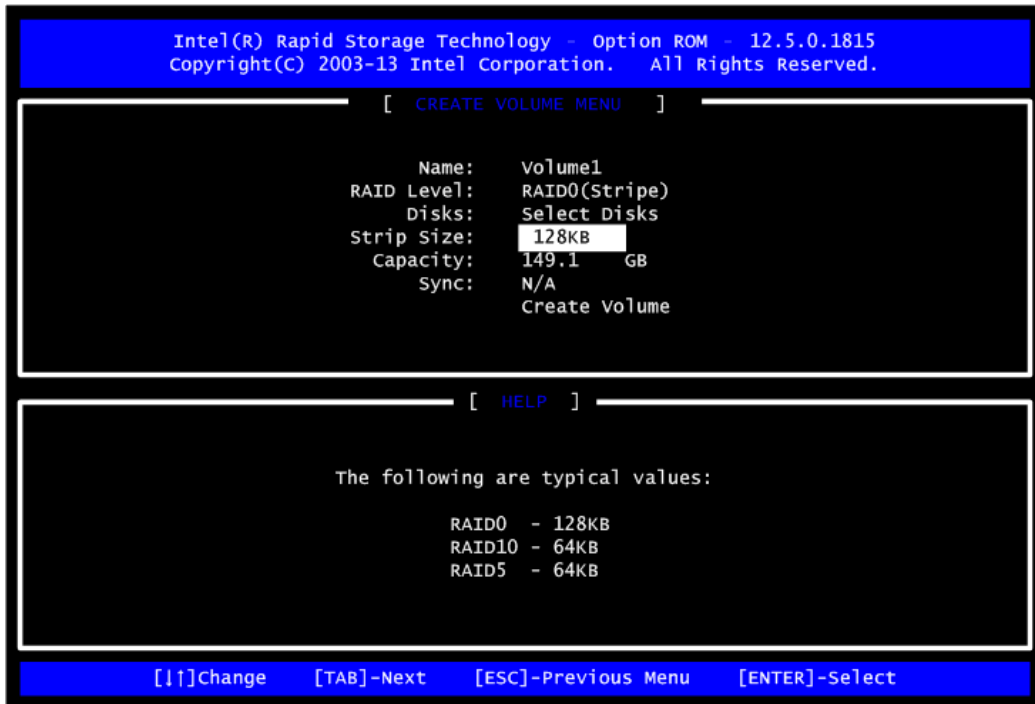

- 3.6. After setting all the items on the menu, select "Create Volume" and press <Enter> to start creating the RAID array.

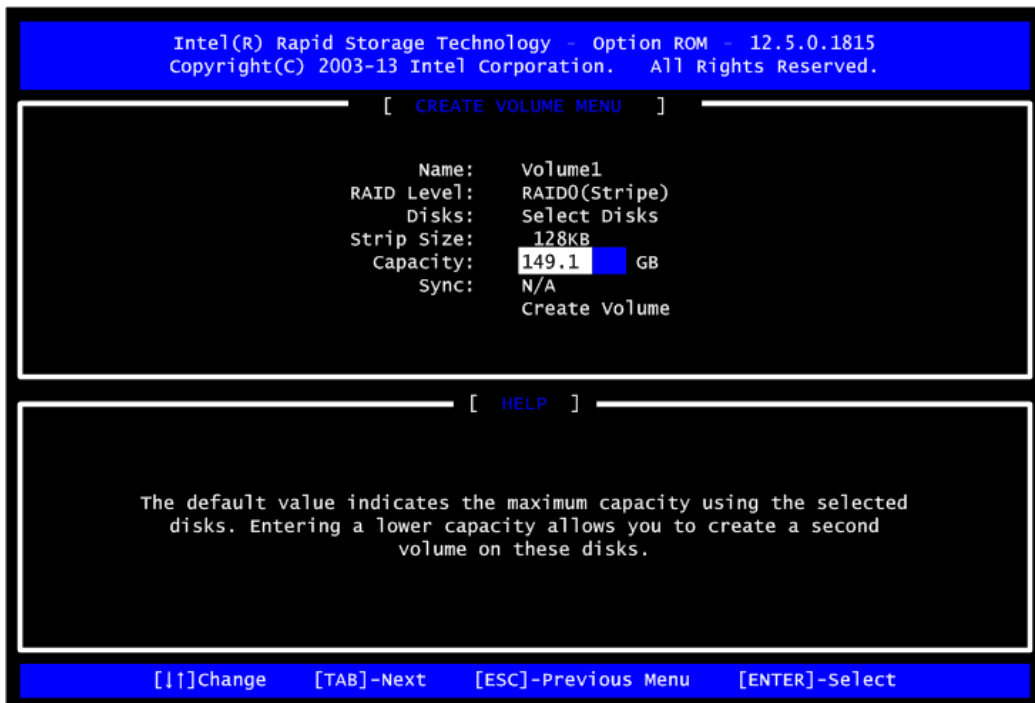

3.7. When prompting for confirmation, press <Y> to create this volume, or <N> to cancel the creation.

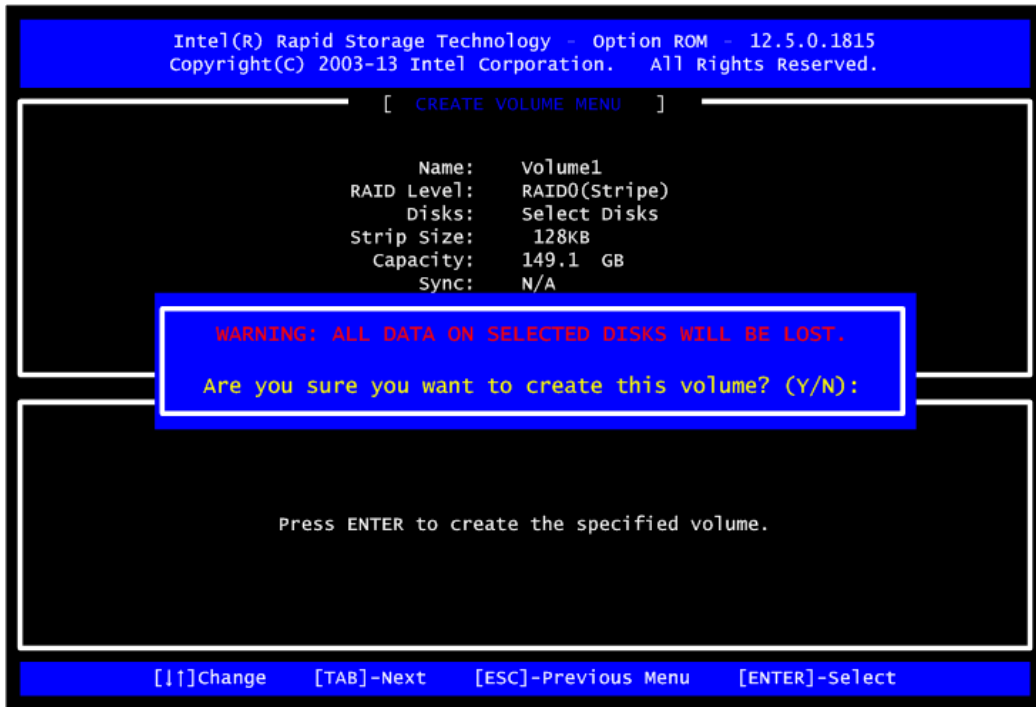

After the creation is completed, you will see detailed information about the RAID Array in the Disk/Volume Information section, including RAID mode, disk block size, disk name, and disk capacity, etc.

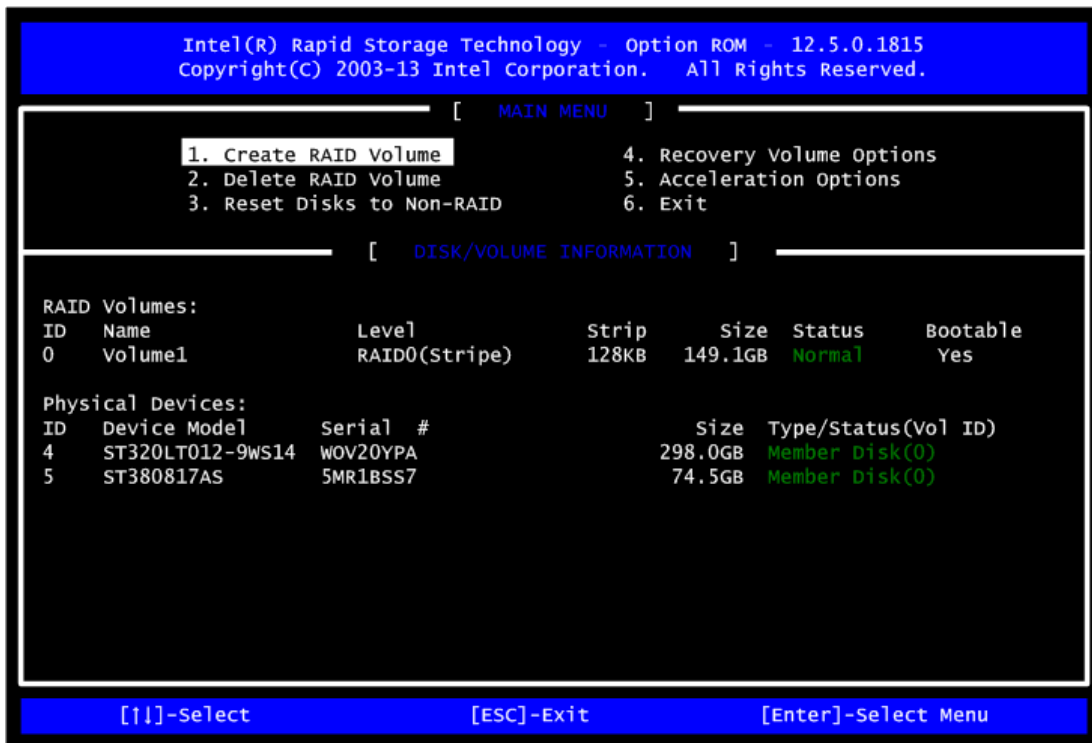

### Delete RAID volume

If you want to delete a RAID volume, select the “Delete RAID Volume” option in the Main Menu. Press <Enter> and follow on-screen instructions.

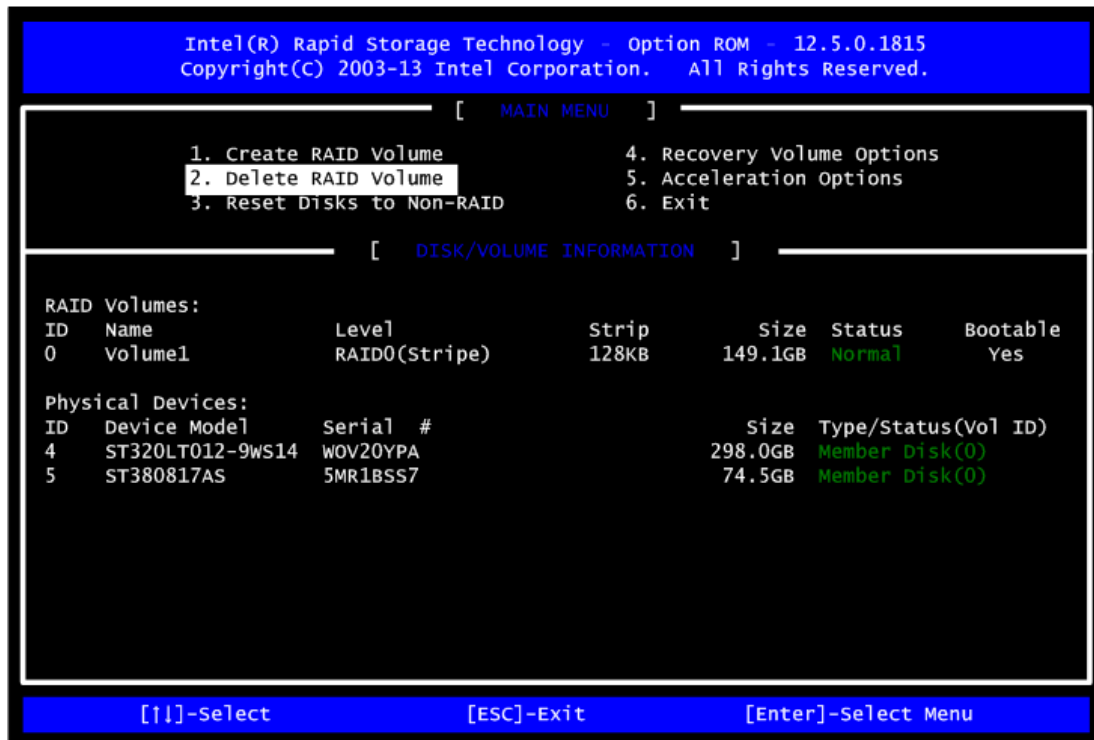

Press <Esc> to exit the RAID BIOS utility. Now, you can proceed to install a SATA driver controller and the operating system.



# Appendix E

## Digital I/O

### Digital I/O Software Programming

- I2C to GPIO PCA9554PW GPIO[3:0] is Output, GPIO[7:4] is Input.
- I2C address: 0b0100100x.
- IOBASE: 0xF040
- Registers:

#### Command byte

Command	Protocol	Function
0	Read byte	Input port register
1	Read/write byte	Output port register
2	Read/write byte	Polarity inversion register
3	Read/write byte	Configuration register

The command byte is the first byte to follow the address byte during a write transmission. It is used as a pointer to determine which of the following registers will be written or read.

#### Register 0: Input port register.

This register is a read-only port. It reflects the incoming logic levels of the pins, regardless of whether the pin is defined as an input or an output by Register 3. Writes to this register have no effect.

The default 'X' is determined by the externally applied logic level, normally '1' when no external signal is externally applied because of the internal pull-up resistors.

Bit	Symbol	Access	Value	Description
7	I7	Read only	X	Determined by externally applied logic level.
6	I6	Read only	X	
5	I5	Read only	X	
4	I4	Read only	X	
3	I3	Read only	X	
2	I2	Read only	X	
1	I1	Read only	X	
0	I0	Read only	X	

**Register 1: Output port register.**

This register reflects the outgoing logic levels of the pins defined as outputs by Register 3. Bit values in this register have no effect on pins defined as inputs. Reads from this register return the value that is in the flip-flop controlling the output selection, not the actual pin value.

Bit	Symbol	Access	Value	Description
7	O7	R	1*	Reflects outgoing logic levels of pins defined as outputs by Register 3.
6	O6	R	1*	
5	O5	R	1*	
4	O4	R	1*	
3	O3	R	1*	
2	O2	R	1*	
1	O1	R	1*	
0	O0	R	1*	

\* : Default value

**Register 3: Configuration register.**

This register configures the directions of the I/O pins. If a bit in this register is set, the corresponding port pin is enabled as an input with high-impedance output driver. If a bit in this register is cleared, the corresponding port pin is enabled as an output. At reset, the I/Os are configured as inputs with a weak pull-up to VDD.

Bit	Symbol	Access	Value	Description
7	C7	R/W	1*	Configure the directions of the I/O pins. 0 = Corresponding port pin enabled as an output. 1 = Corresponding port pin configured as input (default value).
6	C6	R/W	1*	
5	C5	R/W	1*	
4	C4	R/W	1*	
3	C3	R/W	1*	
2	C2	R/W	1*	
1	C1	R/W	1*	
0	C0	R/W	1*	

\* : Default value