

USER'S MANUAL

GOT710A-ELK

**Railway 10.4" XGA TFT LCD
PANEL PC**

User's Manual



www.axiomtek.com

Disclaimers

This manual has been carefully checked and believed to contain accurate information. Axiomtek Co., Ltd. assumes no responsibility for any infringements of patents or any third party's rights, and any liability arising from such use.

Axiomtek does not warrant or assume any legal liability or responsibility for the accuracy, completeness or usefulness of any information in this document. Axiomtek does not make any commitment to update the information in this manual.

Axiomtek reserves the right to change or revise this document and/or product at any time without notice.

No part of this document may be reproduced, stored in a retrieval system, or transmitted, in any form or by any means, electronic, mechanical, photocopying, recording, or otherwise, without the prior written permission of Axiomtek Co., Ltd.

CAUTION

If you replace wrong batteries, it causes the danger of explosion. It is recommended by the manufacturer that you follow the manufacturer's instructions to only replace the same or equivalent type of battery, and dispose of used ones.

©Copyright 2024 Axiomtek Co., Ltd.

All Rights Reserved

Sep. 2024, Version A1

Printed in Taiwan

Safety Precautions

Before getting started, read the following important cautions.

1. Be sure to ground yourself to prevent static charge when installing the internal components. Use a grounding wrist strap and place all electronic components in any static-shielded devices. Most electronic components are sensitive to static electrical charge.
2. Disconnect the power cords from the GOT710A Series before making any installation. Be sure both the system and the external devices are turned OFF. Sudden surge of power could ruin sensitive components. Make sure the GOT710A Series is properly grounded.
3. Do not open the system's top cover. If opening the cover for maintenance is a must, only a trained technician is allowed to do so. Integrated circuits on computer boards are sensitive to static electricity. To avoid damaging chips from electrostatic discharge, observe the following precautions:
 - Before handling a board or integrated circuit, touch an unpainted portion of the system unit chassis for a few seconds. This will help to discharge any static electricity on your body.
 - When handling boards and components, wear a wrist-grounding strap, available from most electronic component stores.

Trademarks Acknowledgments

Axiomtek is a trademark of Axiomtek Co., Ltd.

Windows[®] is a trademark of Microsoft Corporation.

IBM, PC/AT, PS/2, VGA are trademarks of International Business Machines Corporation.

Intel[®] and Pentium[®] are trademarks of Intel Corporation.

AMI is trademark of American Megatrend Inc.

Other brand names and trademarks are the properties and registered brands of their respective owners.

Table of Contents

Disclaimers.....	i
Safety Precautions.....	iii
Section 1 Introduction.....	1
1.1 General Description	1
1.2 Specifications.....	2
1.3 Dimensions and Outlines	4
1.4 I/O Outlets	6
1.5 Packing List.....	7
Section 2 Hardware and Installation	9
2.1 Installing the M.2 & Mini PCIe Card	10
2.2 Serial Ports Interface	13
2.3 USB Ports	13
2.4 Ethernet.....	14
2.5 DIO.....	15
2.6 Audio.....	18
2.7 CAN Bus Connector.....	19
2.8 DC Power Connector	19
2.9 Hard keys on front bezel (Optional).....	20
2.10 LED Indicators.....	21
Section 3 AMI BIOS Setup Utility	23
3.1 Starting.....	23
3.2 Menu Bar.....	24
3.3 Navigation Keys	24
3.4 Main Menu.....	25
3.5 Advanced Menu.....	26
3.6 Chipset Menu.....	40
3.7 Security Menu.....	41
3.8 Boot Menu.....	43
3.9 Save & Exit Menu	44
Appendix A Watchdog Timer	47

Appendix B Windows Power Button Setting 49

This page is intentionally left blank.

Section 1

Introduction

This chapter contains general information and detailed specifications of the GOT710A-ELK. Chapter 1 includes the following sections:



- General Description
- Specification
- Dimensions
- I/O Outlets
- Package List

1.1 General Description

GOT710A-ELK is used to keep the train driver informed about the status of the train's functions.

Its design allows it to be deployed in environment with an extended temperature (-40°~ 70°C) and it also complies with the EMC, shock and vibration test requirements of European standard EN50155 for railway applications.

GOT710A-ELK is equipped with 10.4" TFT ruggedized touch panel computer and all lockable connectors are perfect choice for Human Machine Interface (HMI) in railway environments. The 10.4" railway touch panel PC includes a comprehensive feature set with one CAN Bus, DIO, audio, two Ethernet ports, USB ports and RS-232/422/485.

Railway application-EN50155 Class S3 certificated

Railway power module design support 20ms interruption, EMI EN55022 CLASS A filter, over/short current protection for its railway application.

Sunlight readable design

Its sunlight readable technology with LED tech 500 nits color display allows the screen legible even strong sunlight.

Powerful computing: Intel® Atom Elkhart Lake processors

GOT710A-ELK features Intel® Atom processors that offers reliable and stable performance and rugged environment.

1.2 Specifications

Main CPU Board

- **CPU**
 - Intel® Atom® quad core x6425E 2.0GHz processor onboard
- **System Memory**
 - 1 DDR4 SO-DIMM supports up to 32GB memory capacity
- **BIOS**
 - American Megatrends Inc. UEFI (Unified Extensible Firmware Interface) BIOS.
 - 256Mbit SPI Flash, DMI, Plug and Play.
 - PXE Ethernet Boot ROM.

I/O System

- **Standard I/O**
 - 2 x RS-232/422/485 (M12, A-coded)
 - 2 x 2.5Gbe LAN (M12, X-coded)
 - 2 x USB 2.0 (M12, A-coded)
 - 1 x DIO (6 input/2 output (Phoenix type))
 - 1 x CAN bus (M12, A-coded)
- **Audio**
 - 1 x Audio: Line-out, & Mic-in (M12, A-coded)
- **Expansion**
 - 2 x PCIe Mini Card slots
- **Storage**
 - 1 x 64GB M.2 2242 SATA interface
 - 1 x mSATA
- **Power connector**
 - 1 x DC for power input with isolated (M12, A-coded)

System Specification

- **10.4" XGA (1024 X 768) LCD**
- **Projected Capacitive Touch**
- **IP65, NEMA 4 rugged protection, aluminum front bezel, rest area of enclosure is IP40 rated**
- **Net Weight**
 - 2.69 kg (5.93 lb)
- **Dimension (Main Body Size)**
 - 310 mm (12.20") (W) x 55 mm (2.17") (D) x 214 mm (8.43") (H)
- **Operation Temperature**
 - -40°C to 70°C
- **Relative Humidity**
 - 10% to 90% @ 40°C, Non-Condensing
- **Power Input**
 - 24V to 110VDC, 20ms interruption hold up (EN 50155 Class S3)



NOTE: All specifications and images are subject to change without notice.

1.3 Dimensions and Outlines

The following diagrams show the dimensions and outlines of GOT710A-ELK.

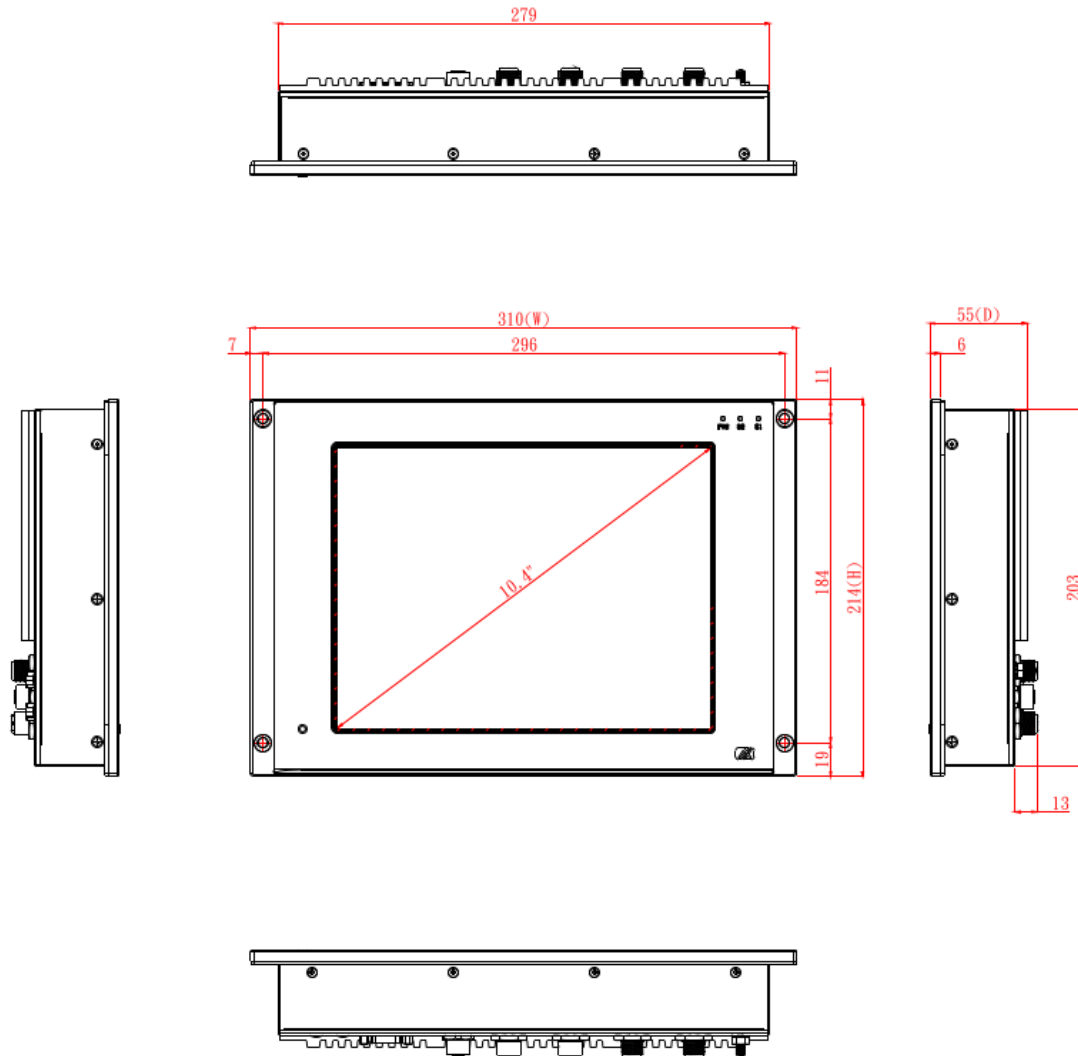

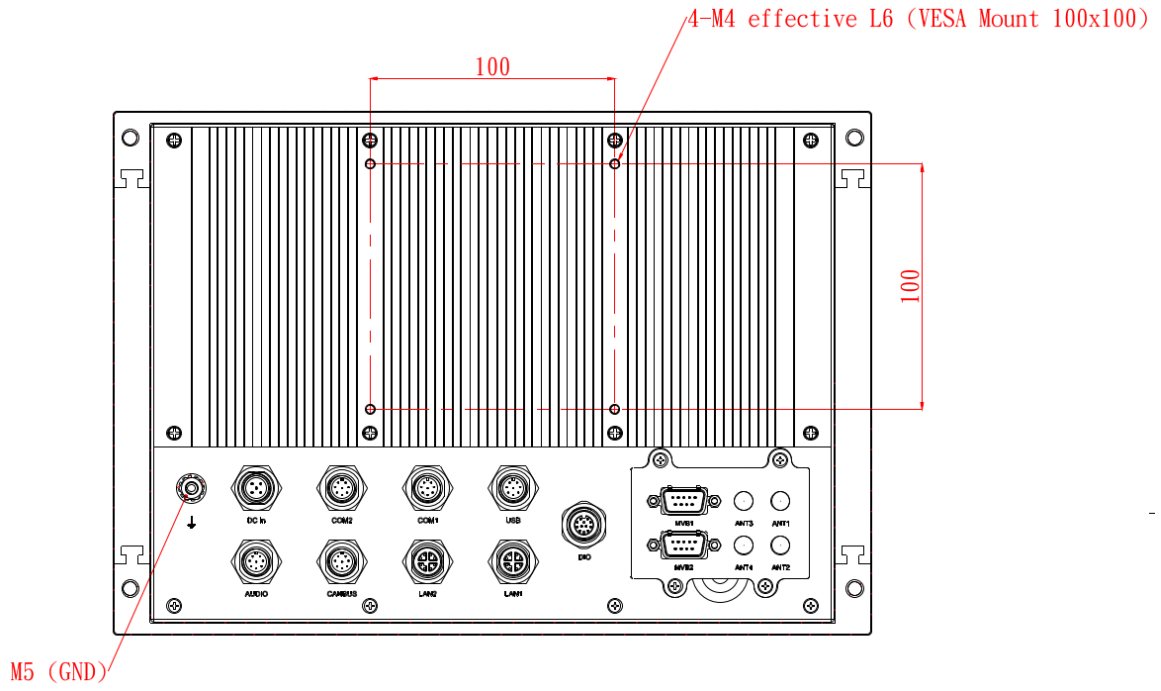

1.4 I/O Outlets

Please refer to the following illustration for I/O locations of the GOT710A-ELK.

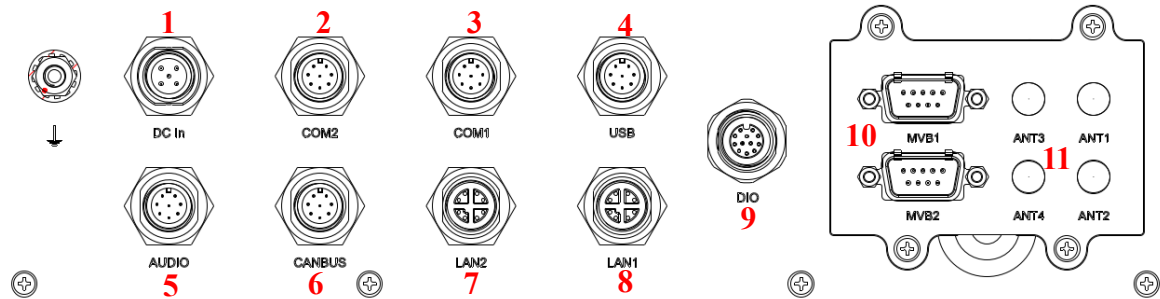

No	Function
1	DC for power input with isolated
2	COM2 with isolated (RS-232/422/485)
3	COM1 with isolated (RS-232/422/485)
4	USB 2.0 x 2
5	Audio (Line out / Mic in)
6	CAN Bus with isolated
7	LAN 2 (100/1000/2500 with isolated)
8	LAN 1 (100/1000/2500 with isolated)
9	DIO (6 input / 2 output with isolated)
10	MVB (option function)
11	Antenna Opening x 4

1.5 Packing List

When you receive the GOT710A-ELK, the bundled package should contain the following items:

- **GOT710A-ELK unit x 1**
- **Phoenix Connector x 1**
- **M.2 Slot screw M3*4L x2**
- **MINIPcie Slot screw M3*5L x2**

If you cannot find the package or any items are missing, please contact Axiomtek distributors immediately.

This page is intentionally left blank.

Section 2

Hardware and Installation

The GOT710A-ELK provides rich I/O ports and flexible expansions for you to meet different demand. The chapter will show you how to install the hardware. It includes:

- Open Back Cover
- Serial Ports Interface
- USB Ports
- Ethernet
- DIO
- Audio
- CANBus Connector
- DC Power Connector
- Mini card Installation
- Hard keys on front bezel
- LED Indicators
- Auto-dimming

2.1 Installing the M.2 & Mini PCIe Card

The GOT710A-ELK provides two Mini card slots for user to install 4G LTE / Wi-Fi / mSATA or GPS cards.

This section tells users how to install M.2 & Mini PCIe Card. Please follow the steps below.

Step 1 Unscrew 8 screws on the back heatsink. Please refer the photo below.



Step 2 Open the back heatsink and find out the M.2 & mini-card slot on main board.

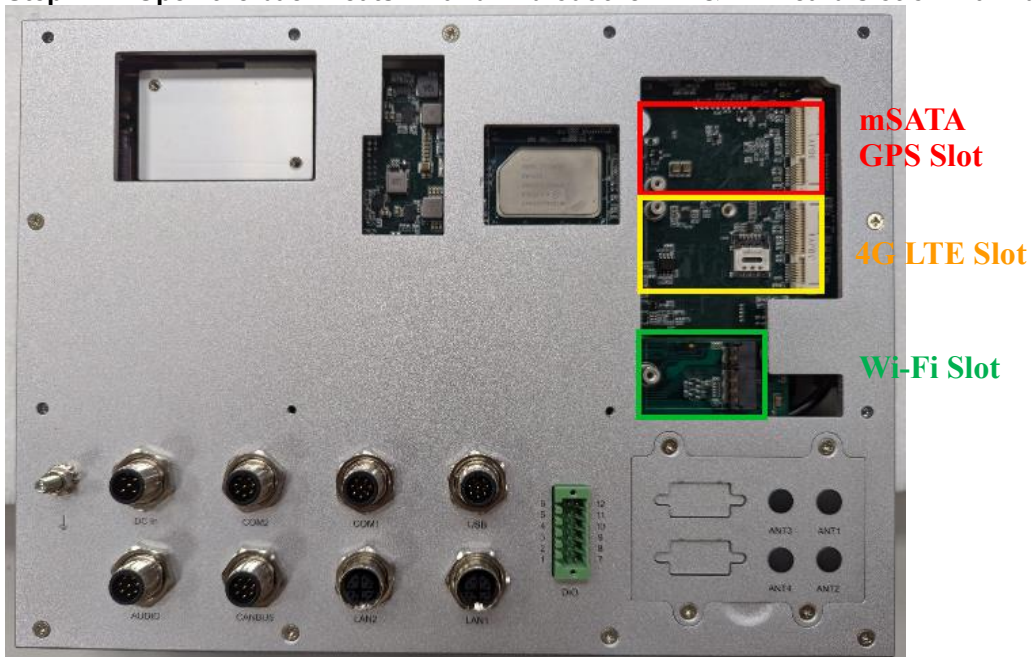

Insert the M.2 LAN card & Mini card to the slot. Screw it firmly on the slot.



Unscrew 4 screws on the back maintain window cover and remove the antenna plug from one antenna hole on the system chassis.

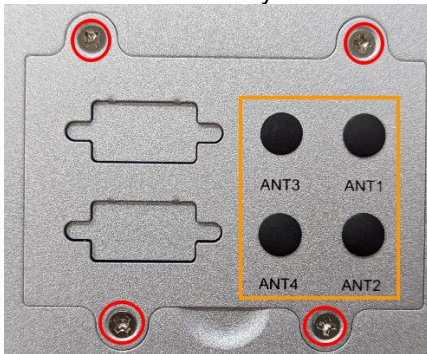

Make the antenna cable's gold connector through the antenna hole on the system chassis to screw it tight with the antenna nut and gasket and screw 4 screws on the back maintain window cover.

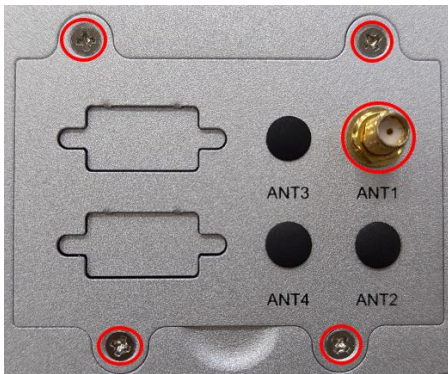

Connect the other end of the cable to the connector on the wireless module.



Push top cover up with SIM Card slot.

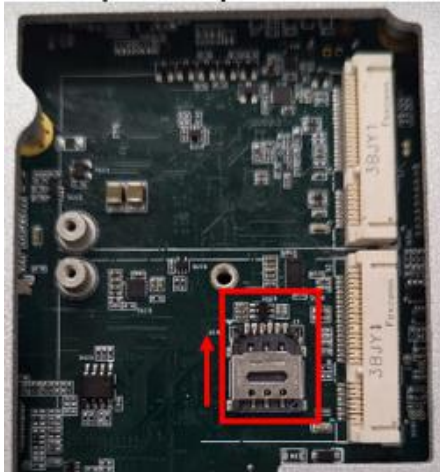

Insert a SIM Card device into the socket.

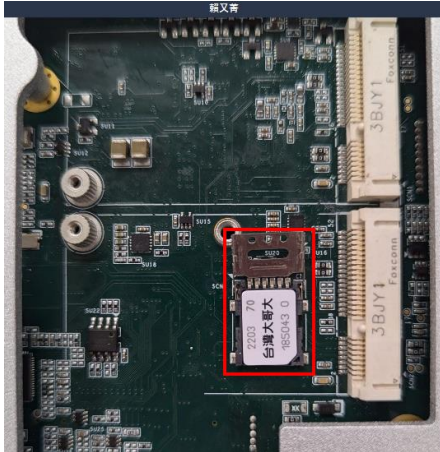

Close the top cover and push the top cover down to secure the SIM Card.

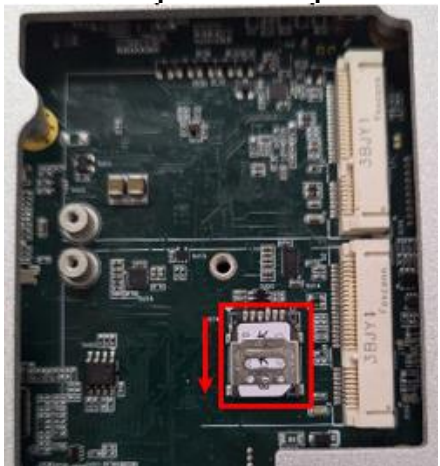

2.2 Serial Ports Interface

This system supports RS-232/422/485 on COM1~COM2 ports.

The pin assignments are listed in table below.

If you need to adjust these COM ports to work as RS-232/422/485, please refer to BIOS setting in section 3.5.

Pin	RS-232	RS-422	RS-485
1	NDCD	TX-	Data-
2	NRX	TX+	Data+
3	NTX	RX+	No use
4	NDTR	RX-	No use
5	NDSR	No use	No use
6	NRTS	No use	No use
7	NCTS	No use	No use
8	ISO_GND	ISO_GND	ISO_GND

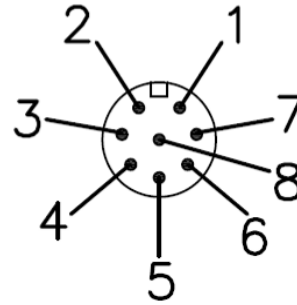

2.3 USB Ports

This system supports two USB ports. The pin assignments are listed in table below.

Pin	Definition
1	USB1_PWR
2	USB_DN1
3	USB_DP1
4	GND
5	USB2_PWR
6	USB_DN2
7	USB_DP2
8	GND

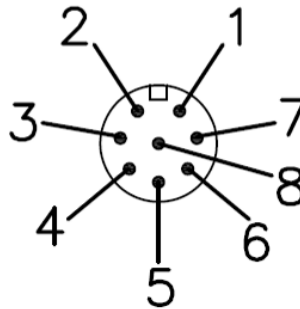

2.4 Ethernet

The GOT710A-ELK is equipped with two high performance plug and play Ethernet interfaces with X-coded. Connection can be established by plugging one end of the Ethernet cable into this RJ-45 connector and the other end to a 2.5Gbe hub with isolated.

Pin	Definition
1	MDI 0+
2	MDI 0-
3	MDI 1+
4	MDI 1-
5	MDI 3+
6	MDI 3-
7	MDI 2-
8	MDI 2+



2.5 DIO

2.5.1 Digital I/O Specification

This system supports one DIO (6 input and 2 output) with isolated. The pin assignments are listed in table below.

Digital Input:

Input channels: 6, sink/source type

Input voltage: 0 to 30VDC at 25Hz

Input level for dry contacts:

Logic level 0: close to ground

Logic level 1: open

Input level for wet contacts:

Logic level 1: +/-3VDC max.

Logic level 0: +/- 10VDC min. to +/-30VDC max. (source to digital input)

Digital output:

output channels: 2, sink type

output current: 200mA max. per channel

on-state voltage: 12~ 24VDC nominal

max. voltage on COM+: 30VDC

Pin	Definition
1	Common PWR+
2	DI4
3	DI5
4	DO0
5	DO1
6	Common PWR-
7	EXT_POWER
8	DI0
9	DI1
10	DI2
11	DI3
12	Isolation GND

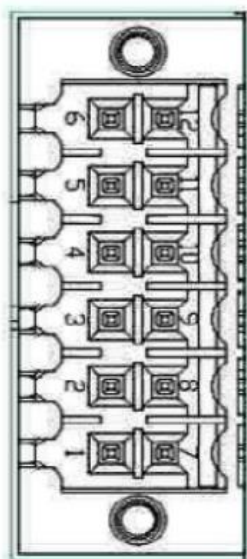

2.5.2 Digital I/O Software Programming

- I2C to GPIO PCA9554PW GPIO Group0[5:0] is Output, Group0[7:6] is Input.
- I2C address: 0b0100100x.
- Registers:

Register 0: Input Group0 register.

Table 4. Register 0 - Input Port register bit description

Bit	Symbol	Access	Value	Description
7	I7	read only	X	determined by externally applied logic level
6	I6	read only	X	
5	I5	read only	X	
4	I4	read only	X	
3	I3	read only	X	
2	I2	read only	X	
1	I1	read only	X	
0	I0	read only	X	

Register 2: Output Group0 register.

Table 5. Register 1 - Output Port register bit description

*Legend: * default value.*

Bit	Symbol	Access	Value	Description
7	O7	R	1*	reflects outgoing logic levels of pins defined as outputs by Register 3
6	O6	R	1*	
5	O5	R	1*	
4	O4	R	1*	
3	O3	R	1*	
2	O2	R	1*	
1	O1	R	1*	
0	O0	R	1*	

2.5.3 Digital Input Wiring

DRY contact
Logic level 0: close to ground Logic level 1: open

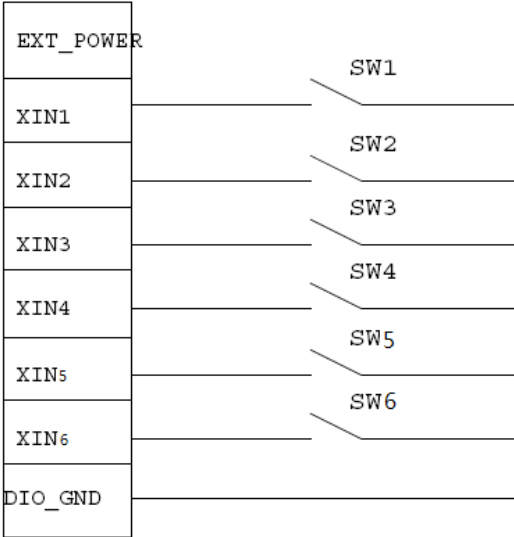

WET contact
Logic level 1: +/-3VDC max.
Logic level 0: +/- 10VDC min. to +/-30VDC max

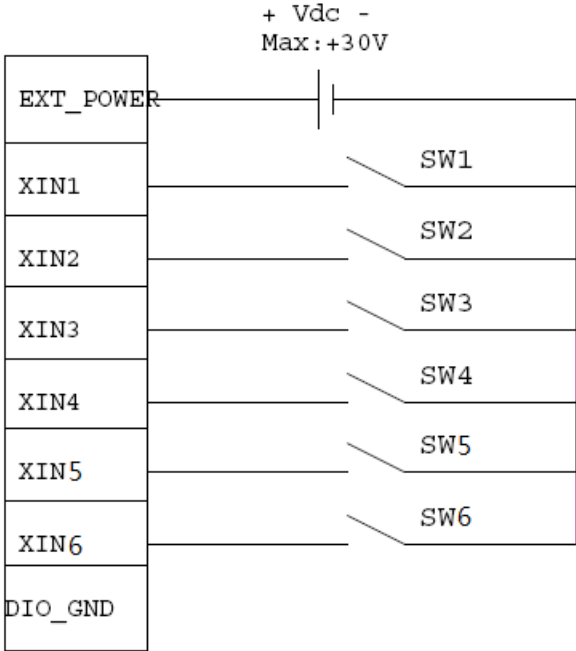

2.5.4 Digital Output Wiring

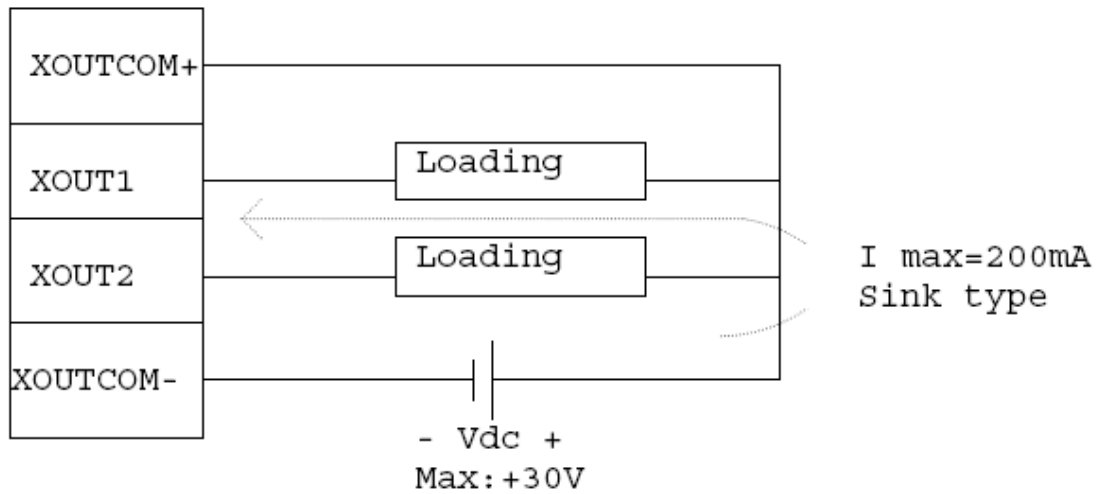

2.6 Audio

This system supports one Audio (Line out / Mic in). The pin assignments are listed in table below.

Pin	Definition
1	MIC-IN-JD
2	MIC-IN
3	AUDIO_OUT_L
4	AUDIO_OUT_R
5	FRONT-JD
6	NA
7	NA
8	AUDIO_GND

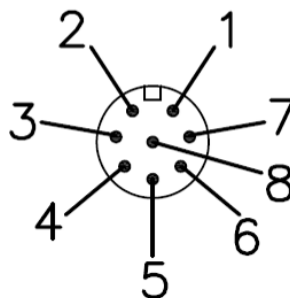

Note: pin# 5 is connected and detected the signal of line- out, signal is switching to line-out.

2.7 CAN Bus Connector

This system supports one CAN Bus. The pin assignments are listed in table below.

Pin	Definition
1	CAN_HO
2	CAN_LO
3	CAN_GND
4	NA
5	NA
6	NA
7	NA
8	NA

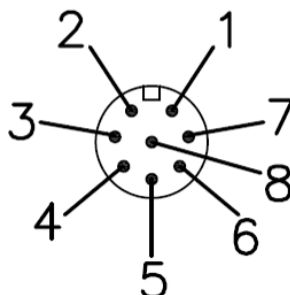

2.8 DC Power Connector

The system supports one DC for power input with isolated. The pin assignments are listed in table below.

Pin	Definition
1	PWR_V+
2	PWR_V+
3	PWR_V-
4	PWR_V-
5	IGN



















NOTE: Default IGN Trigger: Disabled, refer to Smart Ignition Management

2.9 Hard keys on front bezel (Optional)

Hard Keys on front bezel:

- UIC 612-01 compliant
- Keys for pre-defined functions
- Key backlighting: dimmable

SYMBOL	FUNCTION
	Press for windows power button setting
	short press for 1 second (backlight on/off)
	Long press for 3 seconds/Auto dimming on/off
	Customer programming
	Customer programming
	Customer programming
	Volume Up
	Volume Down
	Brightness Up
	Brightness Down
	Customer programming
	backspace
	Cursor Left
	Cursor Right
	Cursor Up
	Cursor Down
	Enter
1	1
2	2
3	3
4	4
5	5
6	6
7	7
8	8
9	9
0	0
F1	F1
F2	F2
F3	F3
F4	F4
F5	F5
F6	F6

Front panel hotkeys define



NOTE: *Keeping pressing one button after 0.8 seconds, the function will be triggered 4 times per seconds repeatedly.*

2.10 LED Indicators

LED lights make sure that whether the MCU is working properly and facilitating to debug in the phrase of research and development. It is not necessarily the actual system mounting LED lights.

The following table summarizes LED indication of the device:

Status	PWR (Green)	S2 (Yellow)	S1 (Red)
Power up	ON	ON	ON
Device working properly	ON	OFF	OFF
High-temperature reminder	ON	Flash	OFF
High-temperature warning	ON	Flash	Flash
Key pressed	Flash	X	X



NOTE:

S2 setting: LED light flashes when the internal temperature of the system reaches 85-95°C.

S1 setting: LED light flashes when the internal temperature of the system reaches 95-100°C.

This page is intentionally left blank.

Section 3

AMI BIOS Setup Utility

The AMI UEFI BIOS provides users with a built-in setup program to modify basic system configuration. All configured parameters are stored in a flash chip to save the setup information whenever the power is turned off. This chapter provides users with detailed description about how to set up basic system configuration through the AMI BIOS setup utility.

3.1 Starting

To enter the setup screens, follow the steps below:

1. Turn on the computer and press <F2> or during the Power On Self Test (POST) to enter BIOS setup, otherwise, POST will continue with its test routines.
2. After you press the key, the main BIOS setup menu displays. You can access the other setup screens from the main BIOS setup menu, such as the Advanced and Chipset menus.



NOTE: *If your computer cannot boot after making and saving system changes with BIOS setup, you can restore BIOS optimal defaults by setting CLRCMOS1 (see section 2.3.1).*

If you wish to enter BIOS setup after POST, restart the system by pressing <Ctrl>+<Alt>+<Delete>, or by pressing the reset button on the system chassis. You may also restart by turning the system off and then back on.

It is strongly recommended that you should avoid changing the chipset's defaults. Both AMI and your system manufacturer have carefully set up these defaults that provide the best performance and reliability.



NOTE: *Because the BIOS setup software is constantly being updated, the following setup screens and descriptions are for reference purpose only, and they may not exactly match what you see on your screen.*

3.2 Menu Bar

The top of the screen has a menu bar with the following selections:

Menu Bar	Description
Main	To set up the system time/date information.
Advanced	To set up the advanced BIOS features.
H/W Monitor	To display current hardware status.
Boot	To set up the default system device to locate and load the operating system.
Security	To set up the security features.
Exit	To exit the current screen or the BIOS setup utility.

Use <<<> key or <>>> key to choose among the selections on the menu bar, and then press <Enter> to get into the sub screen. You can also use the mouse to click your required item.

3.3 Navigation Keys

The BIOS setup/utility uses a key-based navigation system called hot keys. Most of the BIOS setup utility hot keys can be used at any time during the setup navigation process. These keys include <F1>, <F7>, <Enter>, <ESC>, <Arrow> keys, and so on.



NOTE: Some of the navigation keys differ from one screen to another.

Please check the following table for the function description of each navigation key.

Hot Keys	Description
→← Left/Right	The Left and Right <Arrow> keys allow you to select a setup screen.
↑↓ Up/Down	The Up and Down <Arrow> keys allow you to select a setup screen or sub-screen.
+– Plus/Minus	The Plus and Minus <Arrow> keys allow you to change the field value of a particular setup item.
Enter	The <Enter> key allows you to display or change the setup option listed for a particular setup item. The <Enter> key can also allow you to display the setup sub- screens.
F1	The <F1> key allows you to display the General Help screen.
F7	Discard changes.
F9	The <F9> key allows you to load optimal default values for all the settings.
F10	The <F10> key allows you to save any changes you have made and exit Setup. Press the <F10> key to save your changes.
Esc	The <Esc> key allows you to discard any changes you have made and exit the Setup. Press the <Esc> key to exit the setup without saving your changes.

3.4 Main Menu

When you first enter the setup utility, you will enter the Main setup screen. You can always return to the Main setup screen by selecting the Main tab. System Time/Date can be set up as described below. The Main BIOS setup screen is shown below.

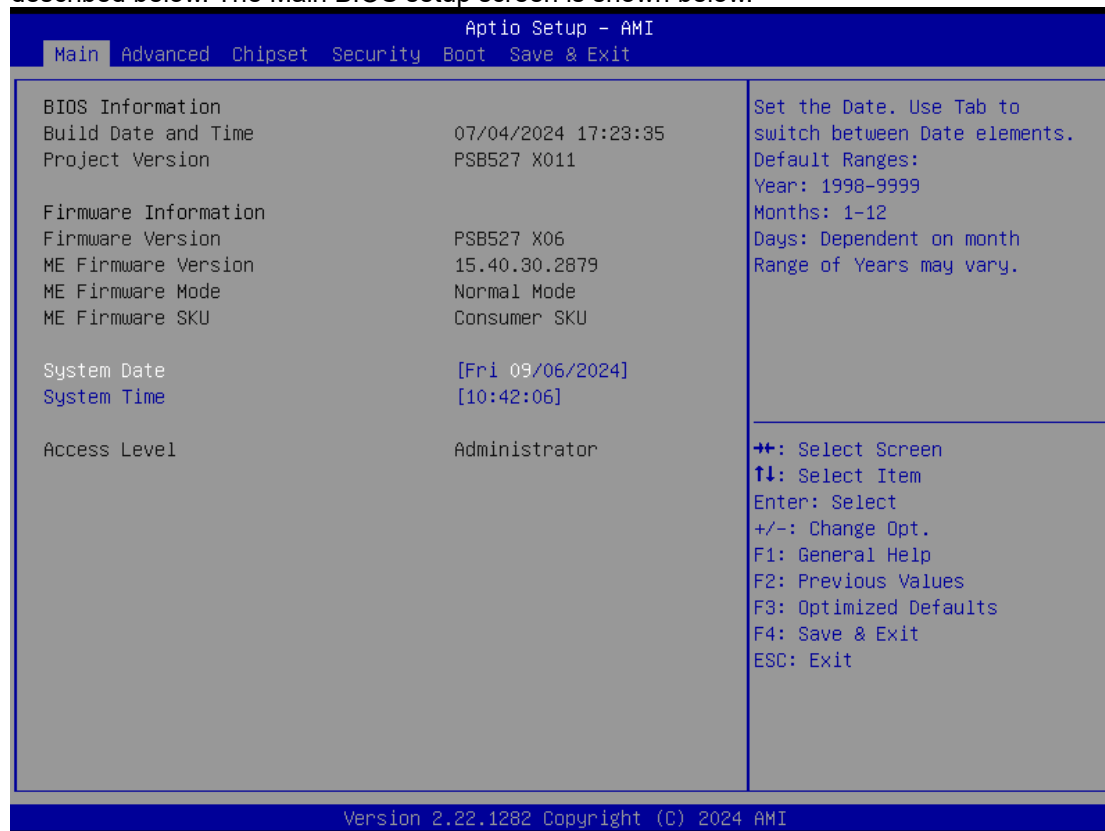

BIOS Information

Display the auto-detected BIOS information.

System Date/Time

Use this option to change the system time and date. Highlight System Time or System Date using the <Arrow> keys. Enter new values through the keyboard. Press the <Tab> key or the <Arrow> keys to move between fields. The date must be entered in MM/DD/YY format. The time is entered in HH:MM:SS format.

3.5 Advanced Menu

The Advanced menu also allows users to set configuration of the CPU and other system devices. You can select any of the items in the left frame of the screen to go to the sub menus:

- F81216 Super IO Configuration
- Hardware Monitor
- Smart Ignition Management
- Trusted Computing
- CPU Configuration
- Storage Configuration
- Memory Configuration
- USB Configuration
- Device Configuration



For items marked with “▶”, please press <Enter> for more options.

- **F81216 Super IO Configuration**

Use this screen to select options for the Super IO Configuration and change the value of the selected option.



Serial Port 1-2 configuration

1. Serial port:

This option used to enable or disable the serial port.

2. Device Setting:

This item specifies the base I/O port address and Interrupt Request address of serial port.

The port 1 Optimal setting is *3F8/IRQ4*.

The port 2 Optimal setting is *2F8/IRQ3*

3. Serial type:

This option used to select RS232/422/485 function.

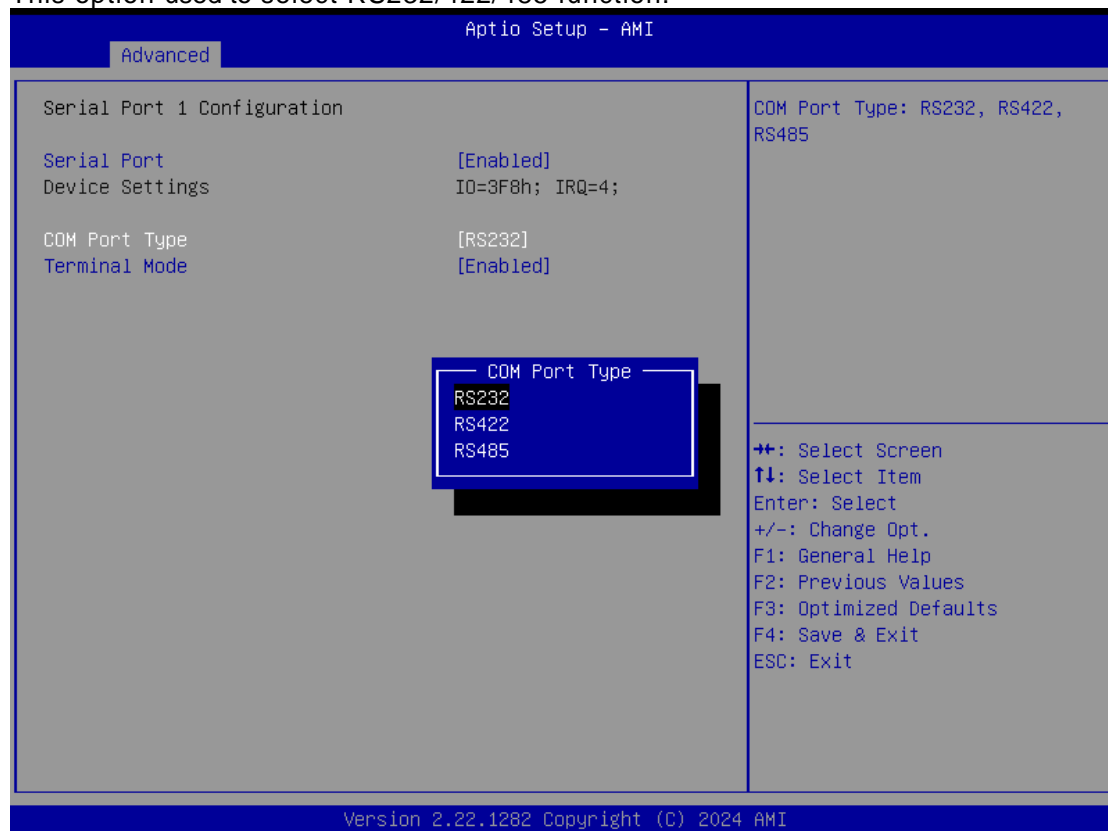

- **Hardware Monitor**

This screen shows the Hardware Health Configuration.

The screenshot displays the 'Advanced' menu in the Aptio Setup - AMI utility. The 'Pc Health Status' section is active, showing the following data:

CPU Temperature	: +24 °C
System Temperature	: +29 °C
VBAT	: +3.23 V
+1.8V	: +1.79 V
+3.3V_SBY	: +3.28 V

Navigation instructions are listed in the bottom right corner:

- ←→: Select Screen
- ↑↓: Select Item
- Enter: Select
- +/-: Change Opt.
- F1: General Help
- F2: Previous Values
- F3: Optimized Defaults
- F4: Save & Exit
- ESC: Exit

Version 2.22.1282 Copyright (C) 2024 AMI

● **Smart Ignition Configuration**

Press Enter to access the sub-menu. Calculated based on the 24-hour military-time clock.

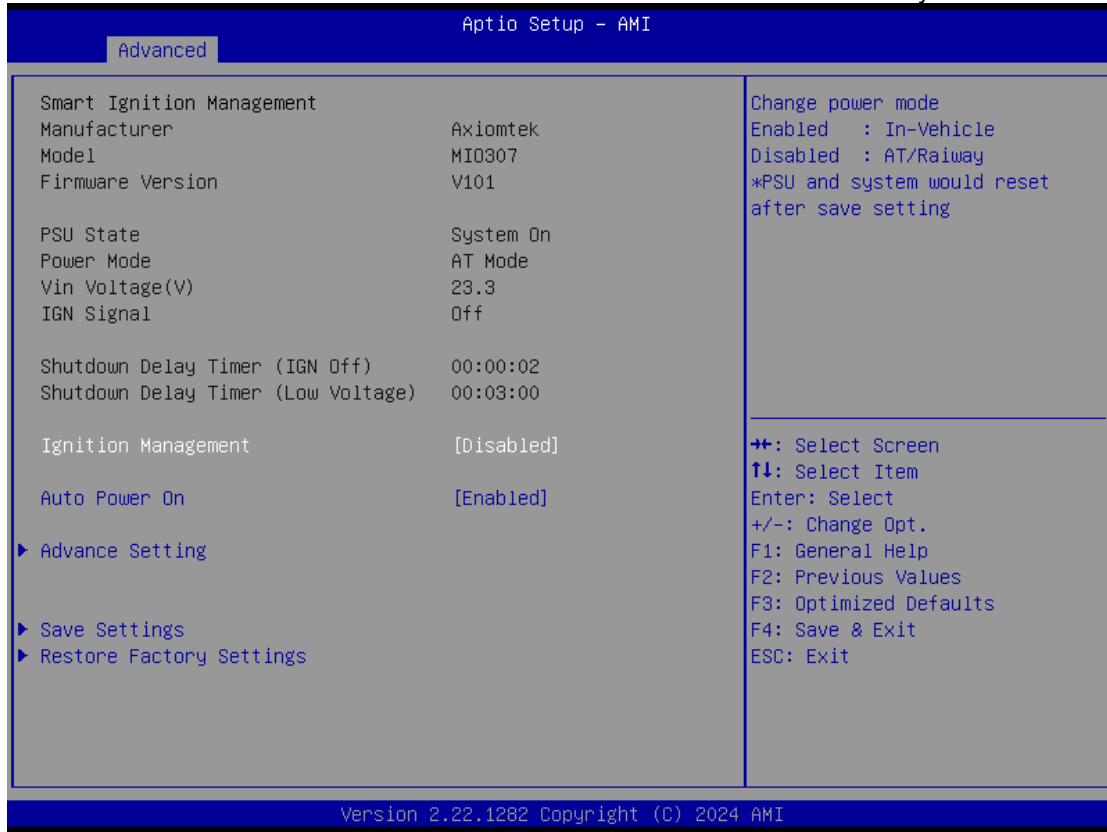

BIOS menu item	Description
Ignition Management	<p>Enabled Switch to In-Vehicle mode *Note: IGN signal will only be triggered when M12 pin5 IGN is connected to VCC, ignition power or ignition control signal.</p> <p>Disabled Switch to AT/Railway mode *Note: System will be reset after Ignition Management setting has been changed and saved.</p> <p>If you want to use IGN signal, please go to the advance setting menu to enable the IGN Trigger option and go back to the previous menu and select save settings to save the changes.</p>
Auto Power On	<ul style="list-style-type: none"> ● Enabled ● System will turn on automatically under following conditions. ● - Manually disconnect and reconnect system power ● - Power interruption: Resume power after power failure ● Disabled ● System will not turn on automatically when power is connected or when power resumes from a power failure.
Advance Setting	<ul style="list-style-type: none"> ● Set system on/off timing and voltage threshold levels
Save Settings	<ul style="list-style-type: none"> ● Save the current settings
Restore Factory Settings	<ul style="list-style-type: none"> ● Restores factory defaults to remove any incorrect or corrupt settings that might have prevented the system from properly powering on/off.

Advanced		Aptio Setup - AMI	
===== Voltage =====			The counter will be activated once power source voltage is smaller than the value of [Low Voltage Trigger], then, system will be forced to turn off when time's up
Activate Voltage Trigger(V)	16		
Low Voltage Trigger(V)	14		
Shutdown Delay Timer (Low Voltage)			
Minium Timer	00:01:00		
Maximum Timer	03:00:00		
Hour	0		
Minute	3		
Second	0		
===== IGN Function =====			
IGN Trigger	[Disabled]		
++: Select Screen ↑↓: Select Item Enter: Select +/-: Change Opt. F1: General Help F2: Previous Values F3: Optimized Defaults F4: Save & Exit ESC: Exit			
Version 2.22.1282 Copyright (C) 2024 AMI			

Advanced		Aptio Setup - AMI	
===== Voltage =====			Enable : IGN signal would trigger [System Turn On Delay] and [Shutdown Delay] Disable: IGN signal would not affect any power management
Activate Voltage Trigger(V)	16		
Low Voltage Trigger(V)	14		
Shutdown Delay Timer (Low Voltage)			
Minium Timer	00:01:00		
Maximum Timer	03:00:00		
Hour	0		
Minute	3		
Second	0		
===== IGN Function =====			
IGN Trigger	[Enabled]		
System Turn On Delay Timer(IGN On)			
Minium Timer	00:00:02		++: Select Screen ↑↓: Select Item Enter: Select +/-: Change Opt. F1: General Help F2: Previous Values F3: Optimized Defaults F4: Save & Exit ESC: Exit
Maximum Timer	00:30:00		
Hour	0		
Minute	0		
Second	2		
Shutdown Delay Timer (IGN Off)			
Minium Timer	00:00:01		
Maximum Timer	06:00:00		
Hour	0		
Minute	0		
Second	2		
Version 2.22.1288 Copyright (C) 2023 AMI			

BIOS menu item	Description
Activate Voltage Trigger	The system turns on when the voltage delivered by the power source is higher than the value you set here.
Low Voltage Trigger	The system will begin the countdown once voltage drops below the value you set here. If the power source voltage does not return to the value higher than [Activate Voltage Trigger] within the time you set for [Shutdown Delay Time (Low Voltage)], the system will shut down and remain off.
Shutdown Delay Timer (Low Voltage)	The timer will be activated once power source voltage drops below the value defined in [Low Voltage Trigger]. The system will be forced to turn off once timer completes countdown.
IGN Trigger	Enable [System Turn On Delay] and [Shutdown Delay] will be triggered by IGN. Disable IGN signal will not affect any power management.



NOTE: Please refer to APPENDIX B for setting the motion in OS application

- Trusted Computing

This sub-menu will allow you to enable/disable Trusted Platform Module (TPM) support and to configure the TPM State. Select Trusted Computing and press Enter to access the sub-menu.

Select the Security Device Support item to enable the TPM device.

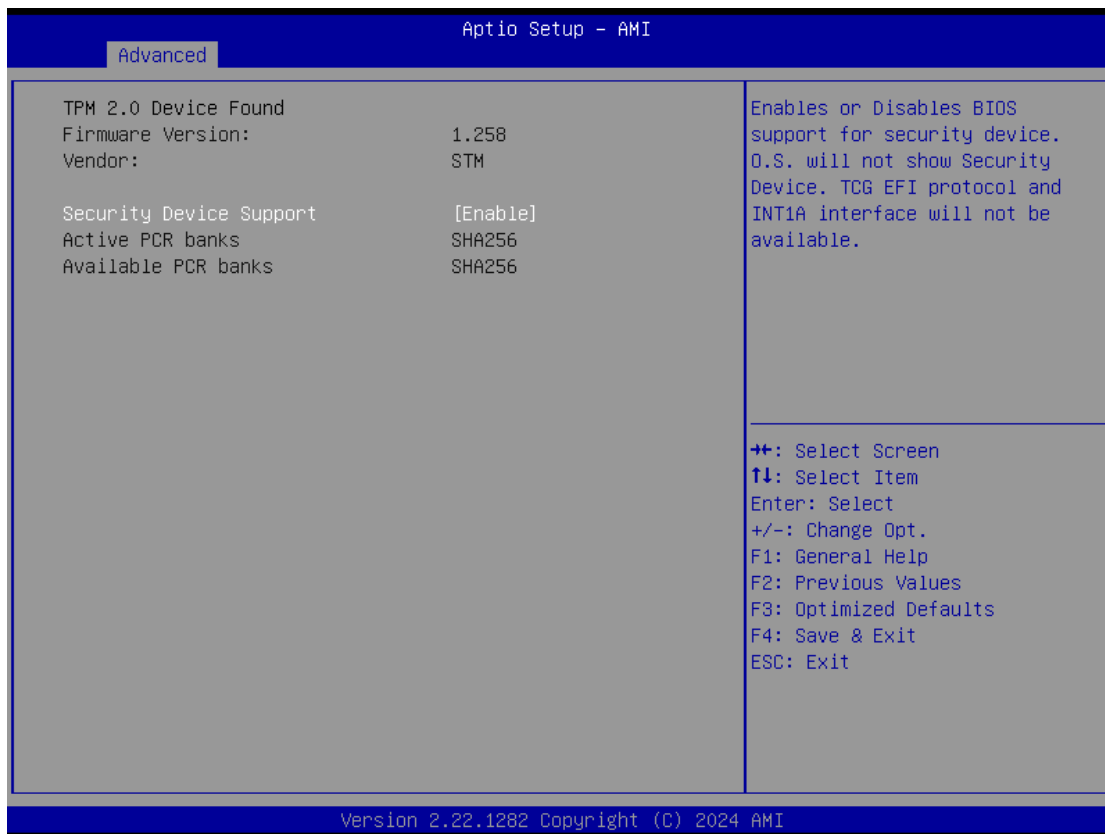

● **CPU Configuration**

This screen shows the CPU configuration, and you can change the value of the selected option.

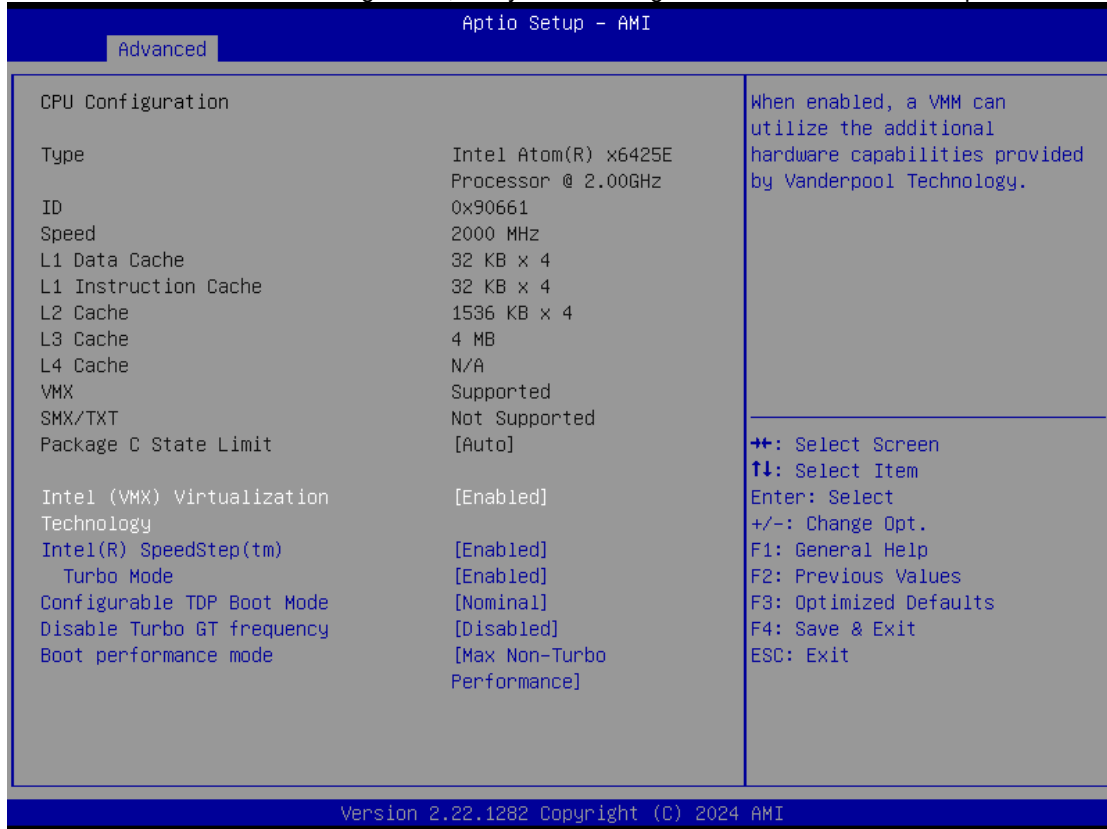

Intel Virtualization Technology

Enable or disable Intel Virtualization Technology. When enabled, a VMM (Virtual Machine Mode) can utilize the additional hardware capabilities.

It allows a platform to run multiple operating systems and applications independently, hence enabling a computer system to work as several virtual systems.

Intel(R) Speed Shift Technology

Enable or disable Intel Speed Shift Technology support.

Enabling will expose the CPPC v2 interface to allow for hardware-controlled P-states.

Turbo Mode

Enable or disable processor Turbo Mode.

- **Storage Configuration**

During system boot up, the BIOS automatically detects the presence of SATA devices. In the SATA Configuration menu, you can see all hardware currently installed in SATA ports.

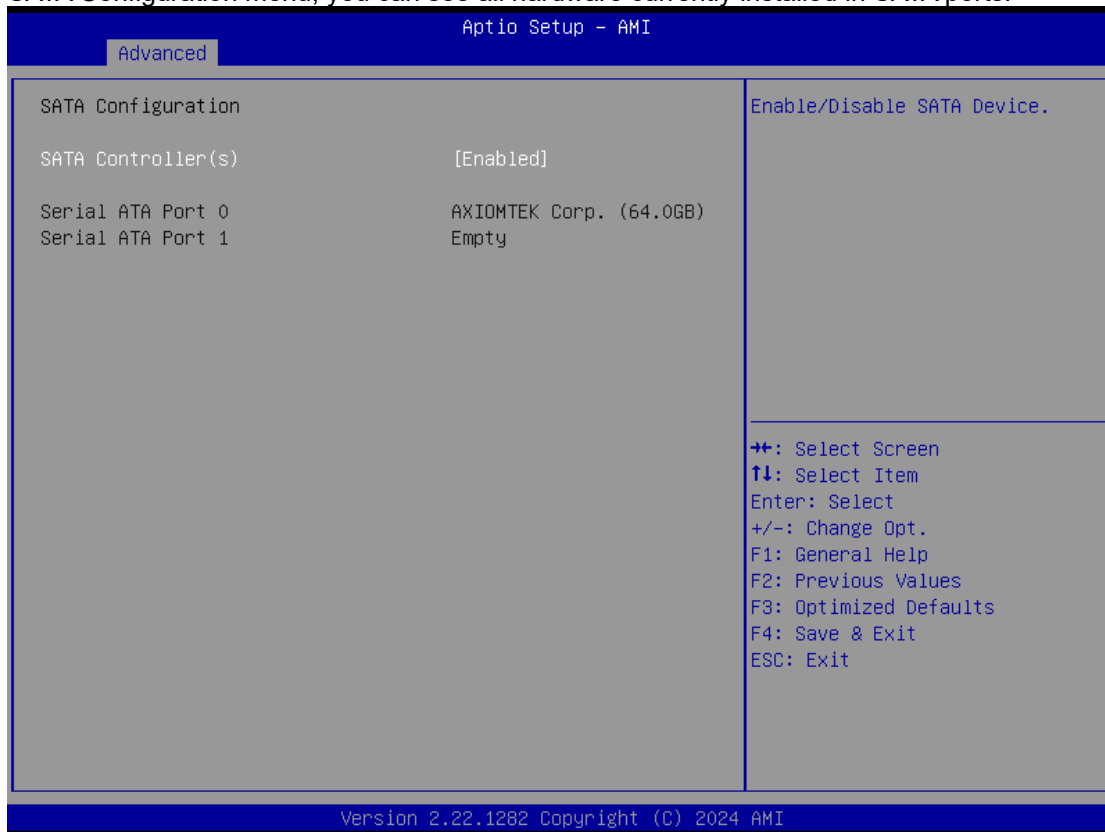
**SATA Controller(s)**

Enable or disable the SATA Controller feature. The default is Enabled.

● **Memory Configuration**

Display memory information with inserted the system.

Aptio Setup - AMI

Advanced

Memory Configuration	
Memory	Size 4096 MB
	Frequency 2400 MTPS
Channel 0 Slot 0	Populated & Enabled
Size	4096 MB (DDR4)
Number of Ranks	1
Manufacturer	UnKnown
Channel 1 Slot 0	Not Populated / Disabled

++: Select Screen
↑↓: Select Item
Enter: Select
+/-: Change Opt.
F1: General Help
F2: Previous Values
F3: Optimized Defaults
F4: Save & Exit
ESC: Exit

Version 2.22.1282 Copyright (C) 2024 AMI

- **USB Configuration**

Display all detected USB devices.

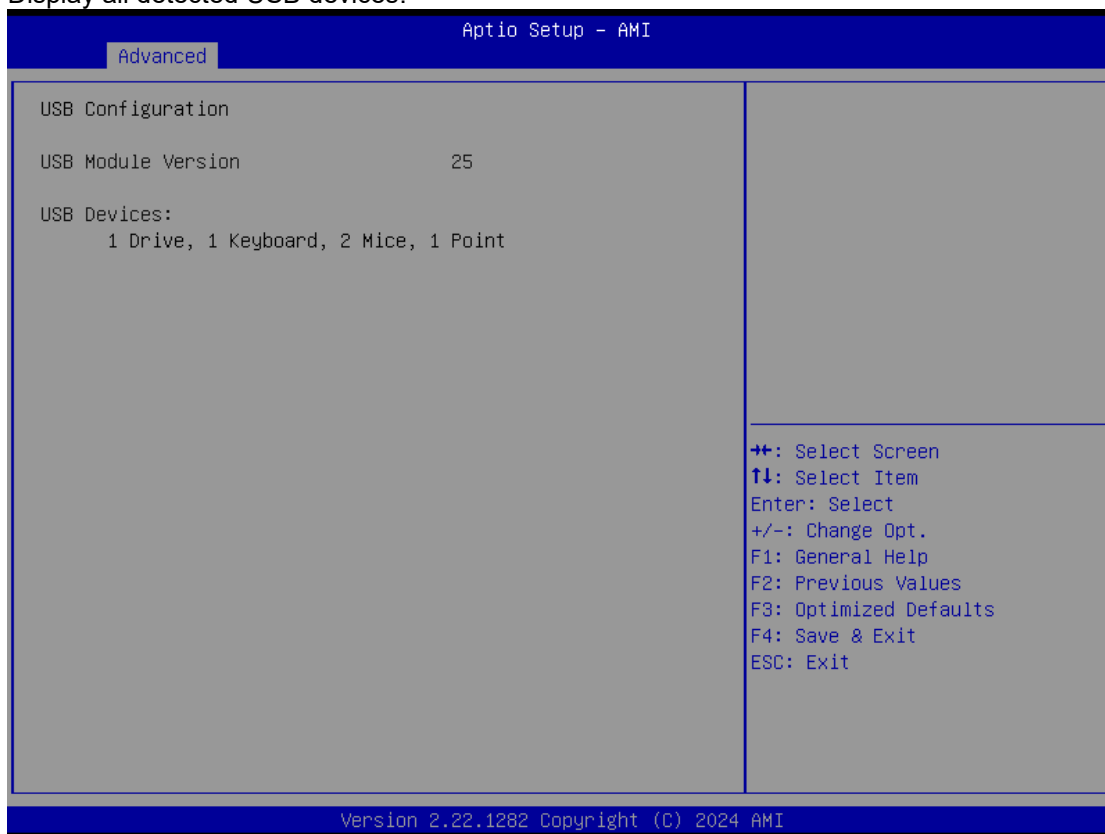

● **Device Configuration**

You can use this screen to select options for the 8-bit Digital I/O Configuration. A description of the selected item appears on the right side of the screen. For items marked with "▶", please press for more options.

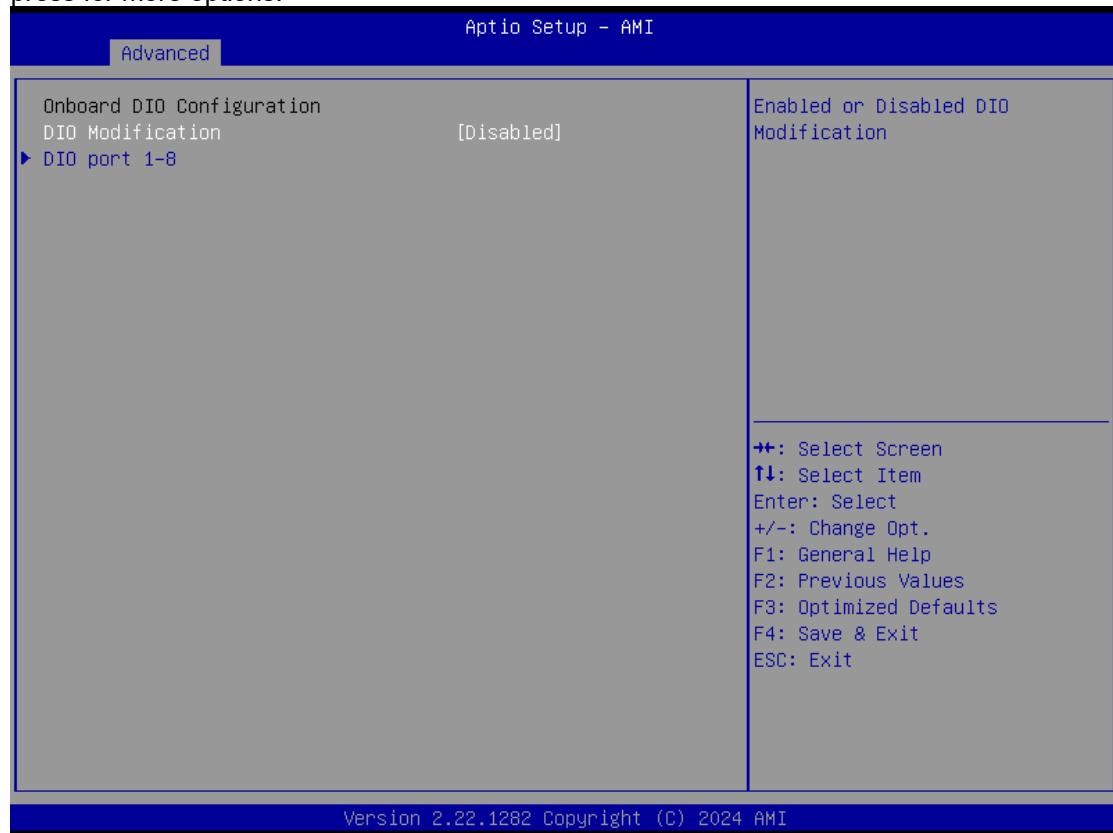

DIO Modification

Enable or disable digital I/O modification. If modification is disabled, the DIO status sub screen is as follows:

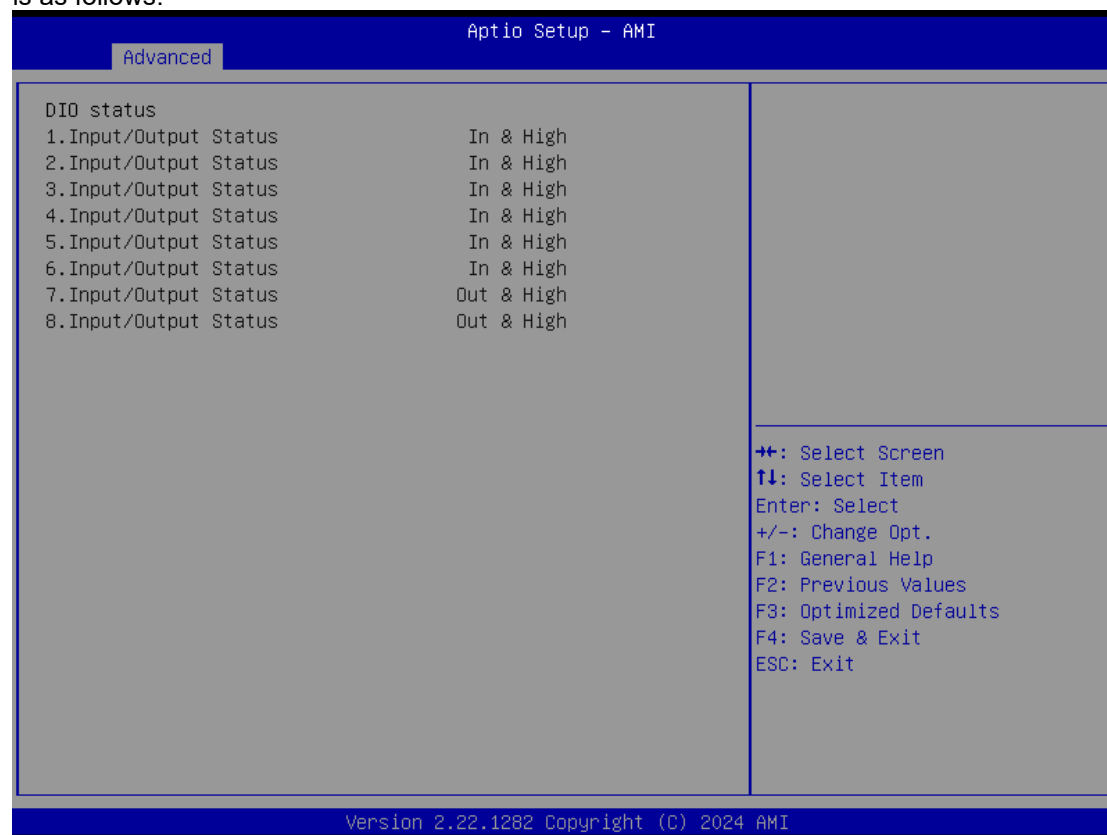

Once it is enabled, you can load manufacture default and access to the DIO status sub screen to set output or input, see image below.

3.6 Chipset Menu

System Agent (SA) Configuration

This screen shows the memory information.

PCH-IO Configuration

You can use this screen to select options for the LVDS Configuration.

Aptio Setup - AMI					
Main	Advanced	Chipset	Security	Boot	Save & Exit
System Agent (SA) Configuration					
Max TOLUD	[Dynamic]	Maximum Value of TOLUD. Dynamic assignment would adjust TOLUD automatically based on largest MMIO length of installed graphic controller			
Graphics Configuration					
IGFX GOP Version	18.0.1041				
IGFX VBIOS Version	N/A				
Primary Display	[Auto]				
Internal Graphics	[Auto]				
PCH-IO Configuration					
State After G3	[S5 State]				
LVDS Panel Device	[Enabled]				
LVDS Panel Type	[1024x768 24Bit]				
			⇐⇐: Select Screen ⇑⇓: Select Item Enter: Select +/-: Change Opt. F1: General Help F2: Previous Values F3: Optimized Defaults F4: Save & Exit ESC: Exit		
Version 2.22.1282 Copyright (C) 2024 AMI					

3.7 Security Menu

The security menu allows users to change the security settings for the system.



Administrator Password

This item indicates whether an administrator password has been set (installed or uninstalled).

User Password

This item indicates whether a user password has been set (installed or uninstalled).

● **Secure Boot**



Secure Boot feature is Active if Secure Boot is Enabled, Platform Key (PK) is enrolled and the System is in User mode. The mode change requires platform reset.

Secure Boot Mode

Secure Boot mode options : Standard or Custom. In Custom mode, Secure Boot Policy variables can be configured by a physically present user without full authentication.

Restore Factory Keys

Force the system into User Mode. Install factory default Secure Boot key databases.

Key Management

Enables expert users to modify Secure Boot Policy variables without full authentication.

3.8 Boot Menu

The Boot menu allows users to change boot options of the system. You can select any of the items in the left frame of the screen to go to the sub menus:

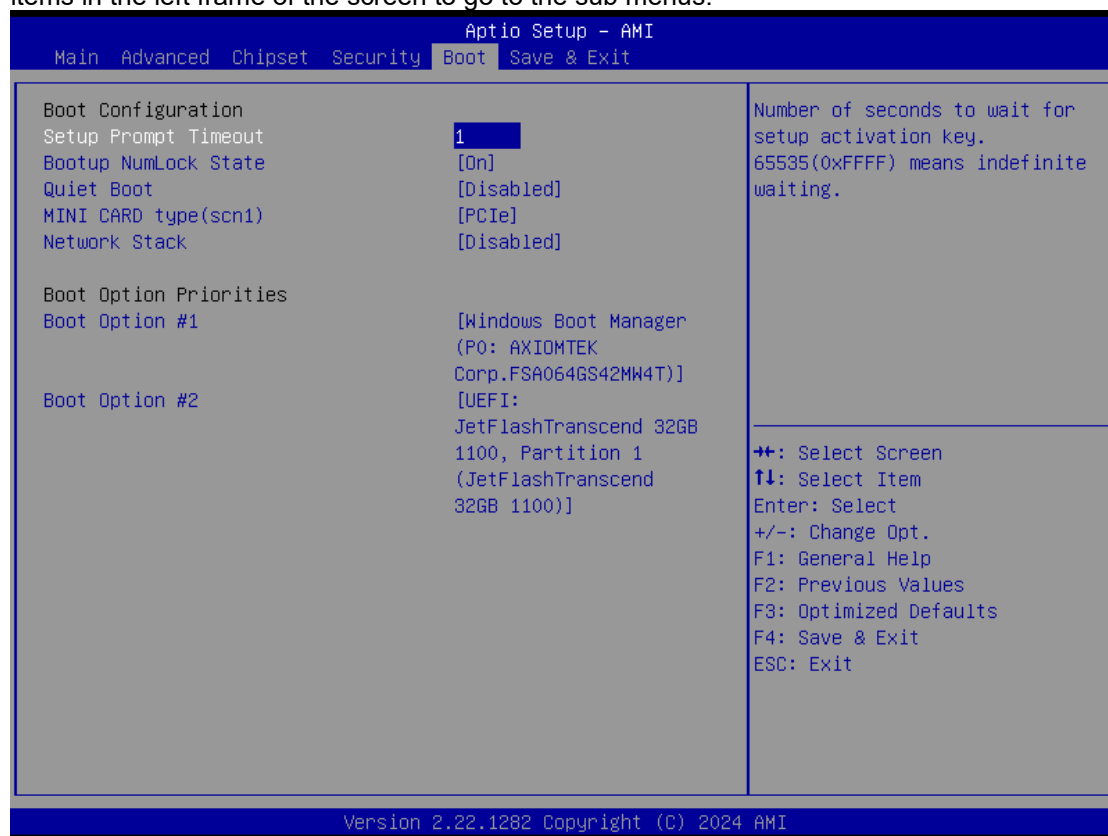

Setup Prompt Timeout

Set the Timeout for wait press key to enter Setup Menu

Bootup NumLock State

Use this item to select the power-on state for the NumLock. The default setting is on.

Quiet Boot

Use this item to enable or disable the Quiet Boot state. The default setting is disable.

MINI CARD type (SCN1)

Set PCI-Express Mini Card (SCN3) to work as PCIe or mSATA. The default is PCIe.

Network Stack

Use this item to enable or disable the PXE boot Execution Environment. The default setting is disable.

Boot Option Priorities

Specifies the overall boot order from the available devices.

3.9 Save & Exit Menu

The Save & Exit menu allows users to load your system configuration with optimal or fail-safe default values.

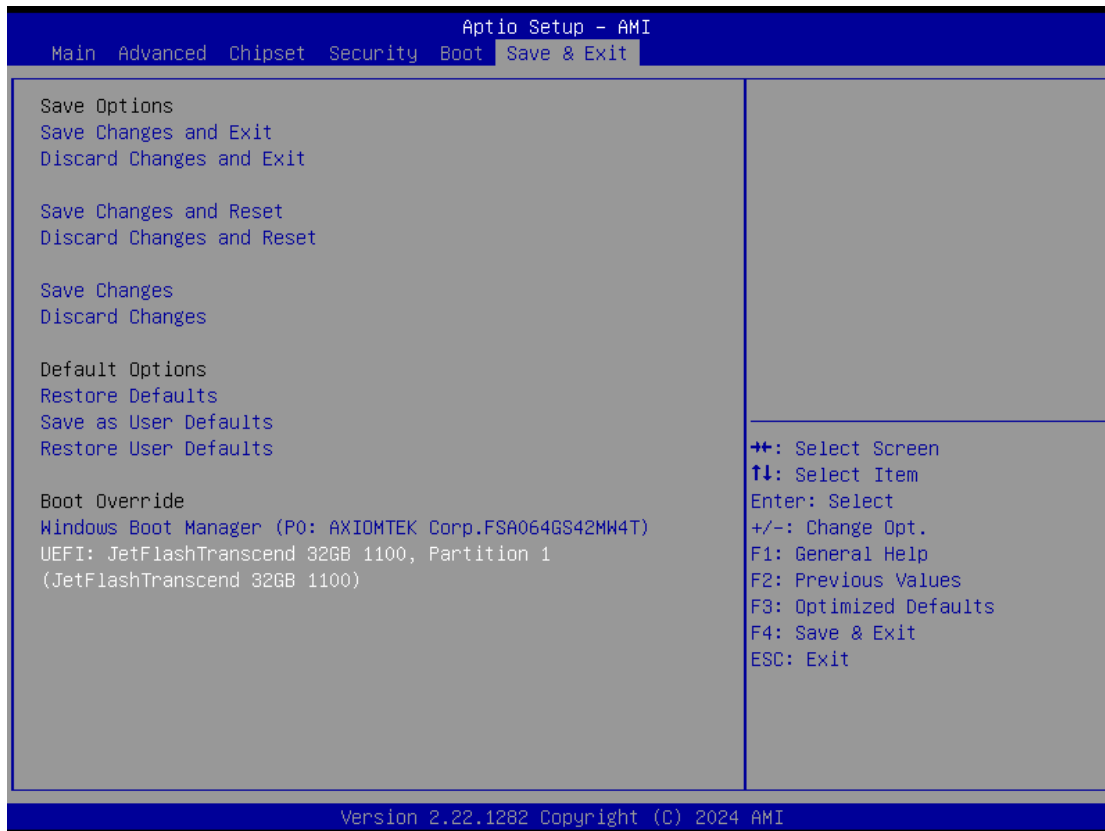

Save Changes and Exit

When you have completed the system configuration changes, select this option to leave Setup and return to Main Menu. Select Save Changes and Exit from the Save & Exit menu and press <Enter>. Select Yes to save changes and exit.

Discard Changes and Exit

Select this option to quit Setup without making any permanent changes to the system configuration and return to Main Menu. Select Discard Changes and Exit from the Save & Exit menu and press <Enter>. Select Yes to discard changes and exit.

Save Changes and Reset

When you have completed the system configuration changes, select this option to leave Setup and reboot the computer so the new system configuration parameters can take effect. Select Save Changes and Reset from the Save & Exit menu and press <Enter>. Select Yes to save changes and reset.

Discard Changes and Reset

Select this option to quit Setup without making any permanent changes to the system configuration and reboot the computer. Select Discard Changes and Reset from the Save & Exit menu and press <Enter>. Select Yes to discard changes and reset.

Save Changes

When you have completed the system configuration changes, select this option to save changes. Select Save Changes from the Save & Exit menu and press <Enter>. Select Yes to save changes.

Discard Changes

Select this option to quit Setup without making any permanent changes to the system configuration. Select Discard Changes from the Save & Exit menu and press <Enter>. Select Yes to discard changes.

Restore Defaults

It automatically sets all Setup options to a complete set of default settings when you select this option. Select Restore Defaults from the Save & Exit menu and press <Enter>.

Save as User Defaults

Select this option to save system configuration changes done so far as User Defaults. Select Save as User Defaults from the Save & Exit menu and press <Enter>.

Restore User Defaults

It automatically sets all Setup options to a complete set of User Defaults when you select this option. Select Restore User Defaults from the Save & Exit menu and press <Enter>.

Boot Override

Select a drive to immediately boot that device regardless of the current boot order

This page is intentionally left blank.

Appendix A

Watchdog Timer

A.1 About Watchdog Timer

After the system stops working for a while, it can be auto reset by the watchdog timer. The integrated watchdog timer can be set up in the system reset mode by program.

A.2 How to Use Watchdog Timer

Assembly sample code:

```
mov     dx , fa10           ; 5 seconds(Maximum is 65535 seconds; fill in
                           ; 0xFA10 and 0xFA11 register, ex: 0xFA11=0x01,
                           ; 0xFA10=0x68 means 360 seconds)

mov     al , 05
out     dx,al

mov     dx,fa12           ;Enable WDT
mov     al,01
out     dx,al
```

This page is intentionally left blank.

Appendix B

Windows Power Button Setting

Please enter the power button setting through the PC console, and then follow below steps to complete the setting.

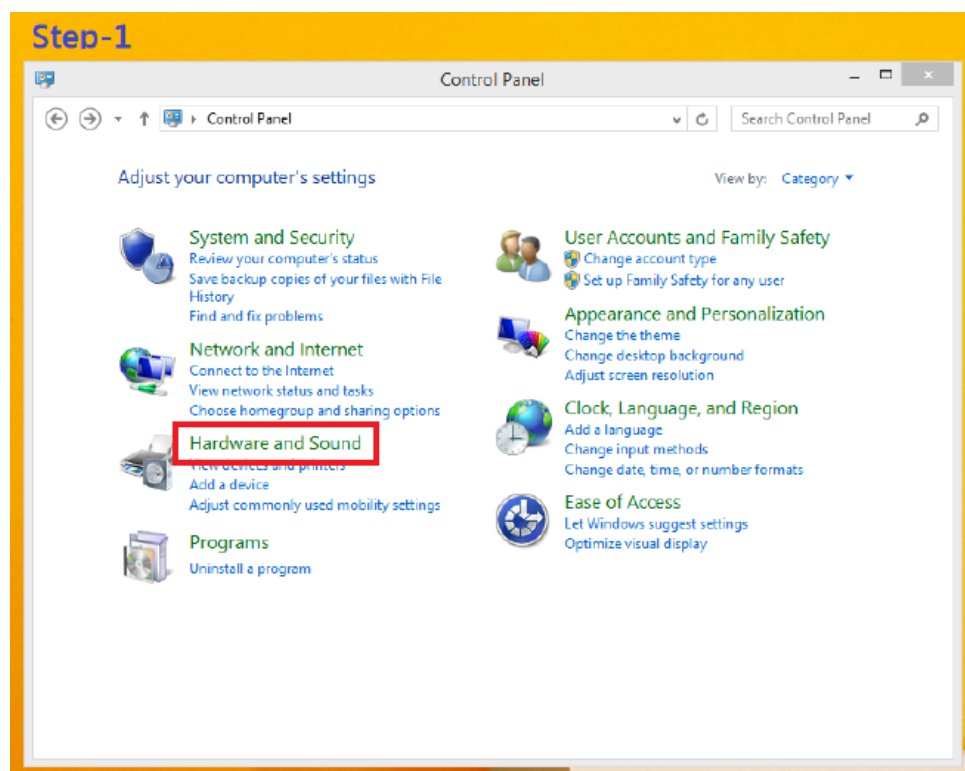

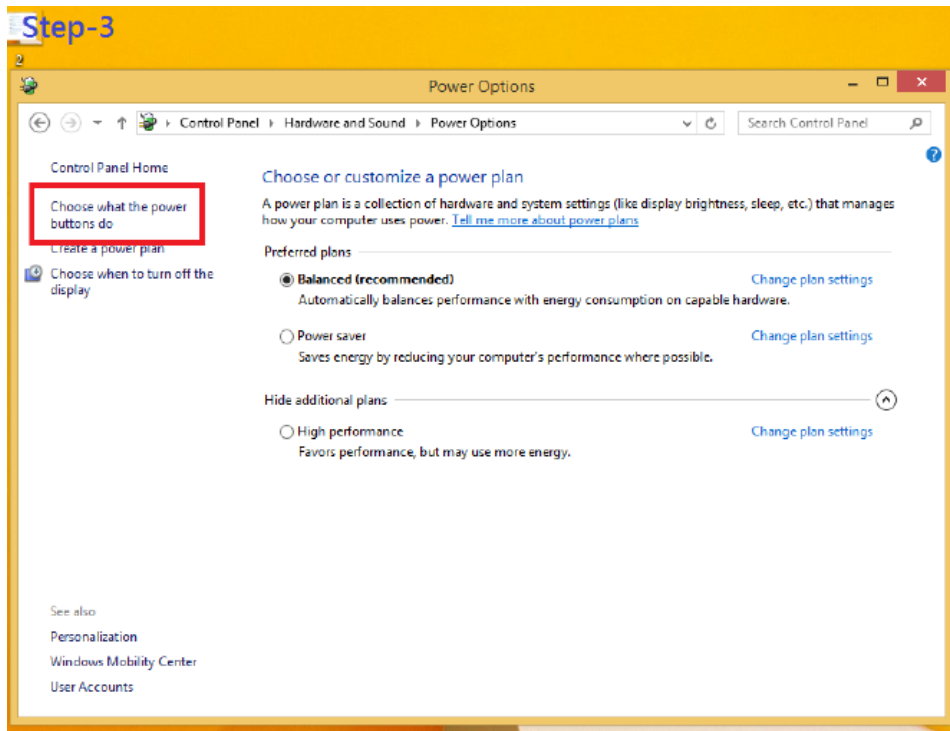
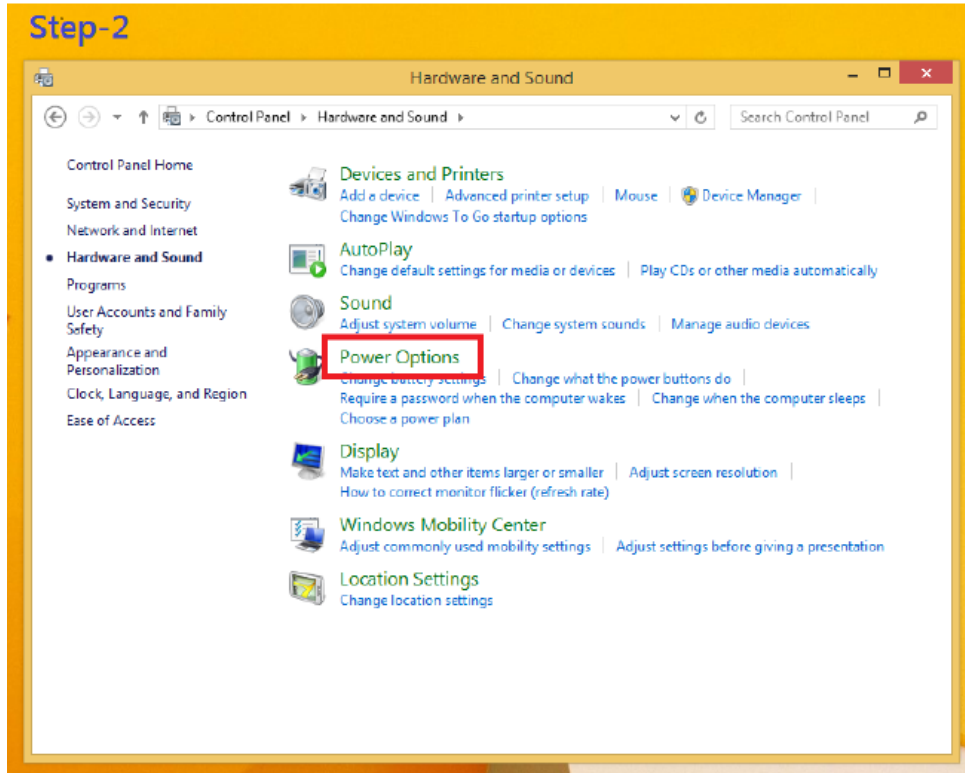

When IGN function has been used, the power button's setting must be switched to "Shut down" as below. Then the system can be shut down normally, after IGN has been turned off.

