

USER'S MANUAL

CAPA55R

**11th Generation Intel® Core™ i7/ i5/ i3
and Celeron® 3.5" Board**

User's Manual



www.axiomtek.com

Disclaimers

This manual has been carefully checked and believed to contain accurate information. Axiomtek Co., Ltd. assumes no responsibility for any infringements of patents or any third party's rights, and any liability arising from such use.

Axiomtek does not warrant or assume any legal liability or responsibility for the accuracy, completeness or usefulness of any information in this document. Axiomtek does not make any commitment to update the information in this manual.

Axiomtek reserves the right to change or revise this document and/or product at any time without notice.

No part of this document may be reproduced, stored in a retrieval system, or transmitted, in any form or by any means, electronic, mechanical, photocopying, recording, or otherwise, without the prior written permission of Axiomtek Co., Ltd.

CAUTION

If you replace wrong batteries, it causes the danger of explosion. It is recommended by the manufacturer that you follow the manufacturer's instructions to only replace the same or equivalent type of battery, and dispose of used ones.

©Copyright 2023 Axiomtek Co., Ltd.

All Rights Reserved

October 2023, Version A3

Printed in Taiwan

ESD Precautions

Computer boards have integrated circuits sensitive to static electricity. To prevent chipsets from electrostatic discharge damage, please take care of the following jobs with precautions:

- Do not remove boards or integrated circuits from their anti-static packaging until you are ready to install them.
- Before holding the board or integrated circuit, touch an unpainted portion of the system unit chassis for a few seconds. It discharges static electricity from your body.
- Wear a wrist-grounding strap, available from most electronic component stores, when handling boards and components.

Trademarks Acknowledgments

Axiomtek is a trademark of Axiomtek Co., Ltd.

Intel® and Celeron® are trademarks of Intel Corporation.

Windows® is a trademark of Microsoft Corporation.

AMI is a trademark of American Megatrend Inc.

IBM, PC/AT, PS/2, VGA are trademarks of International Business Machines Corporation.

Other brand names and trademarks are the properties and registered brands of their respective owners.

Table of Contents

Disclaimers.....	ii
ESD Precautions	iii
Section 1 Introduction.....	1
1.1 Features	2
1.2 Specifications.....	2
1.3 Utilities	3
Section 2 Board and Pin Assignments.....	5
2.1 Board Dimensions and Fixing Holes.....	5
2.2 Board Layout.....	8
2.3 Installing Thermal Solution	10
2.3.1 Installing Cooling Fan.....	10
2.3.2 Installing Heatsink	11
2.4 Installing M.2 2230 Key E and M.2 2280 Key M.....	12
2.5 Jumper and Switch Settings	13
2.5.1 LVDS/eDP Voltage Selection (JP1).....	14
2.5.2 Restore BIOS Optimal Defaults (SW1)	14
2.5.3 Auto Power On (SSW1)	14
2.6 Connectors	15
2.6.1 SATA Power Connector (CN1)	16
2.6.2 USB 3.2 Gen2 Wafer Connector (CN2)	16
2.6.3 LVDS Connector (CN3).....	17
2.6.4 USB 2.0 Wafer Connectors (CN4 and CN5).....	19
2.6.5 M.2 Key M Connector (CN6).....	20
2.6.6 SIM Card Wafer Connector (CN7)	21
2.6.7 HD Audio Interface Wafer Connector (CN8)	21
2.6.8 Inverter Connector (CN9).....	21
2.6.9 M.2 Key E Connector (CN10)	22
2.6.10 I ² C Connector (CN11).....	23
2.6.11 Digital I/O Wafer Connector (CN12).....	23
2.6.12 Front Panel Connector (CN14)	24
2.6.13 DisplayPort++ Connector (CN15)	25
2.6.14 HDMI Connector (CN16).....	25
2.6.15 Power Connector (CN17/ATX1/ATX2)	26
2.6.16 COM Wafer Connectors (COM1 and COM2).....	26
2.6.17 SATA Connector (SATA1).....	27
2.6.18 Ethernet Ports (LAN1 and LAN2).....	27
2.6.19 USB 3.2 Gen2 Type A Port (CN13/USB1).....	28
2.6.20 CMOS Battery Connector (BAT1)	28

2.6.21	eDP Connector (SCN1).....	29
2.6.22	M.2 Key B Connector (SCN2).....	30
2.6.23	Fan Connector (SCN3)	31

Section 3 Hardware Description 33

3.1	Microprocessors	33
3.2	BIOS	33
3.3	System Memory.....	33
3.4	I/O Port Address Map.....	34
3.5	Interrupt Controller (IRQ) Map	35
3.6	Memory Map	40

Section 4 AMI BIOS Setup Utility 41

4.1	Starting.....	41
4.2	Navigation Keys	41
4.3	Main Menu.....	43
4.4	Advanced Menu.....	44
4.5	Chipset Menu.....	57
4.6	Security Menu.....	59
4.7	Boot Menu.....	60
4.8	Save & Exit Menu	61

Appendix A Watchdog Timer..... 63

A.1	About Watchdog Timer	63
A.2	Watchdog Timer Programming	63

Appendix B Digital I/O 65

B.1	About Digital I/O	65
B.2	Digital I/O Programming	65

Appendix C iAMT Settings 67

C.1	Entering MEBx.....	67
C.2	Set and Change Password	67
C.3	iAMT Configuration.....	69
C.4	iAMT Web Console.....	77

This page is intentionally left blank.

Section 1

Introduction

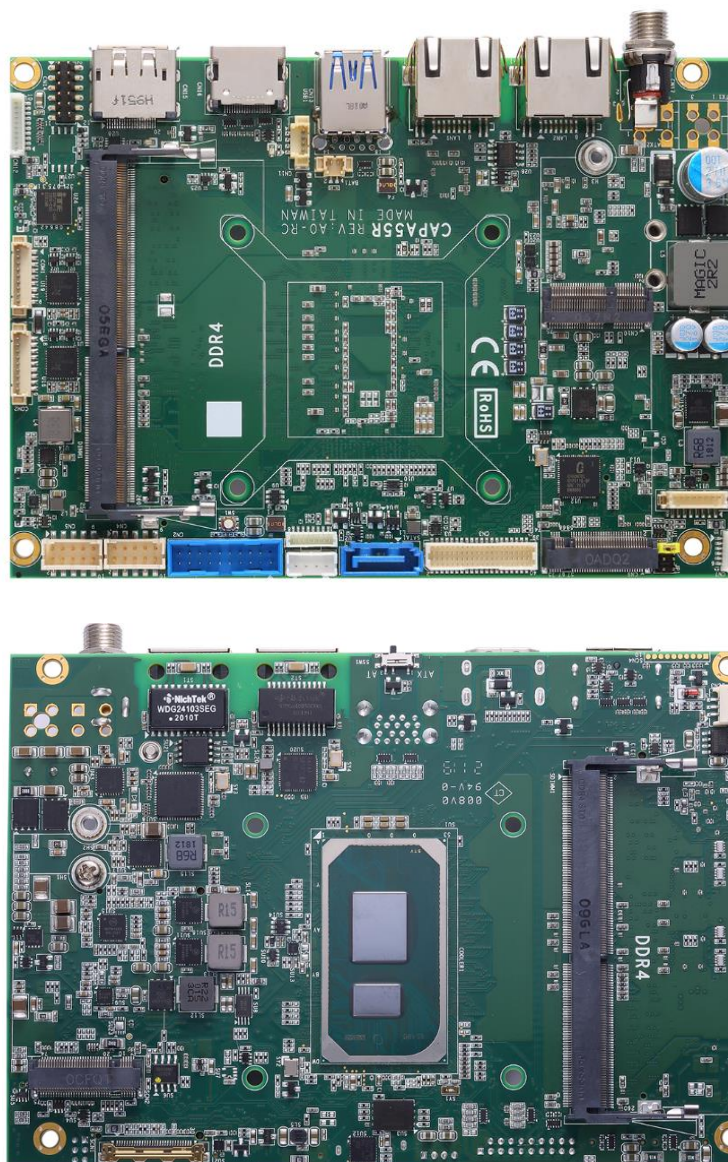

The CAPA55R is a 3.5" board supporting 11th Generation Intel® Core™ i7/ i5/ i3 and Celeron® processor. It delivers outstanding system performance through high-bandwidth interfaces, multiple I/O functions for interactive applications and various embedded computing solutions.

The CAPA55R has two 260-pin unbuffered SO-DIMM sockets for single channel DDR4 2400/3200 MHz memory with maximum capacity up to 64GB. There are two Ethernet ports – one is Gigabit and the other is 2.5 Gigabit, one SATA port with transfer rate up to 6Gb/s, three USB 3.2 Gen 2 super speed compliant, four USB 2.0 high speed compliant, and HD audio link that can achieve the best stability and reliability for industrial applications. Additionally, it provides you with unique embedded features, such as two serial ports (RS-232/422/485) and 3.5" form factor that applies an extensive array of PC peripherals.

1.1 Features

- 11th Generation Intel® Core™ i7/ i5/ i3 and Celeron® processor
- 2 DDR4 SO-DIMM supports total up to 64 GB memory capacity
- 3 USB 3.2 Gen 2 ports
- 4 USB 2.0 ports
- 2 COM ports
- 1 Gigabit Ethernet port and 1 2.5 Gigabit Ethernet port
- 1 M.2 Key B
- 1 M.2 Key E
- 1 M.2 Key M
- +12V~+24V wide range DC-in supported

1.2 Specifications

- **CPU**
 - 11th Generation Intel® Core™ i7/ i5/ i3 and Celeron® processor.
- **Thermal Solution**
 - Active (cooler).
 - Passive (heatsink)
- **Operating Temperature**
 - 0°C to 60°C. (cooler)
 - -20°C to 60°C (heatsink)
- **BIOS**
 - American Megatrends Inc. UEFI (Unified Extensible Firmware Interface) BIOS.
 - 256Mbit SPI Flash, DMI, Plug and Play.
- **System Memory**
 - Two 260-pin unbuffered DDR4 SO-DIMM socket.
 - Maximum up to 32GB DDR4 3200MHz memory per channel.
- **Onboard Multi I/O**
 - Controller: IT5571
 - Two serial ports: Supports RS-232/422/485 by BIOS selecting.
- **Storage**
 - One SATA-600 connector.
 - One M.2 Key M connector in 22x80 (PCIe x4).
- **USB Interface**
 - One USB ports with fuse protection and complies with USB Spec. Rev. 3.2 Gen 2 in Type A connector.
 - Two USB ports with fuse protection and complies with USB Spec. 3.2 Gen 2 in one 2x10 19-pin wafer connector.
 - Four USB ports with fuse protection and complies with USB Spec. Rev. 2.0 in two 2x5-pin wafer connectors.

- **Display**
 - One HDMI with resolution max. up to 3840x2160 @30Hz.
 - One DisplayPort supports DP++ with max. resolution 4096x2160 @60Hz.
 - One 2x20-pin connector for 18/24-bit single/dual channel LVDS with one 8-pin inverter connector. LVDS resolution is up to 1920x1200 in 24-bit dual channels.
 - One 30-pin connector for eDP with resolution max. up to 1920x1080 (Optional).
- **Watchdog Timer**
 - 1~65536 seconds or minutes; up to 65536 levels.
- **Ethernet**
 - Two Ethernet ports.
 - LAN1: Intel® I225-LM supports 2500/1000/100/10Mbps Gigabit/Fast Ethernet with Wake-on-LAN, PXE Boot ROM in RJ-45 connector.
 - LAN2: Intel® I219-LM supports 1000/100/10Mbps Gigabit/Fast Ethernet with Wake-on-LAN, PXE Boot ROM in RJ-45 connector.
- **Audio**
 - HD audio link without codec.
- **Expansion Interface**
 - One M.2 Key E connector in 22x30.
 - One M.2 Key B connector in 30x42 and 30x52
- **Power Input**
 - DC jack
 - One 2x2-pin connector 90D type/ One 2x2-pin connector 180D type.
 - +12V~+24V wide range DC-in.
 - AT (auto power on) function supported.
- **Power Management**
 - ACPI (Advanced Configuration and Power Interface).
- **Form Factor**
 - 3.5" form factor.



Note

All specifications and images are subject to change without notice.

1.3 Utilities

- Chipset and graphics driver
- Ethernet driver
- ME driver

This page is intentionally left blank.

Section 2

Board and Pin Assignments

2.1 Board Dimensions and Fixing Holes

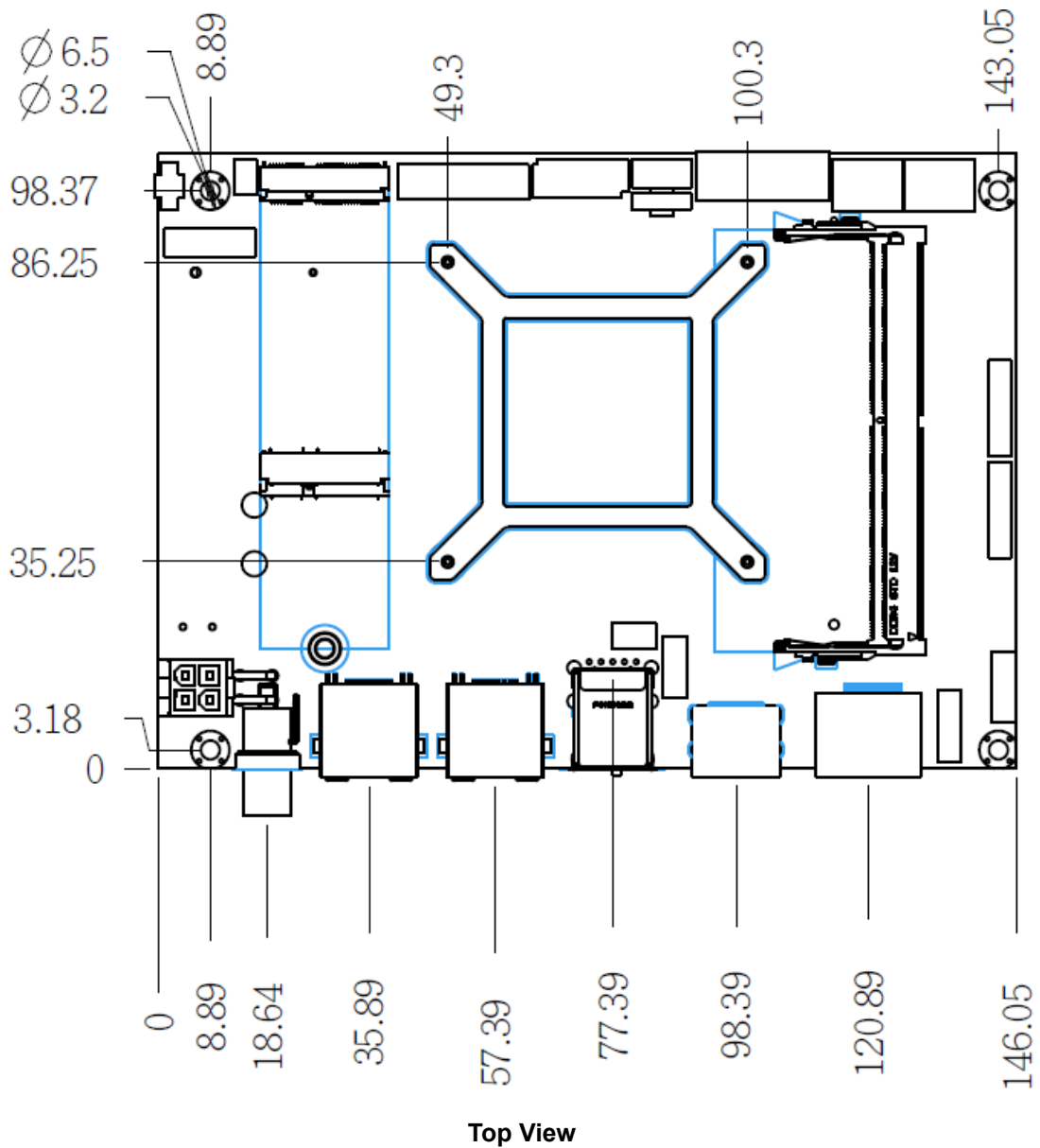

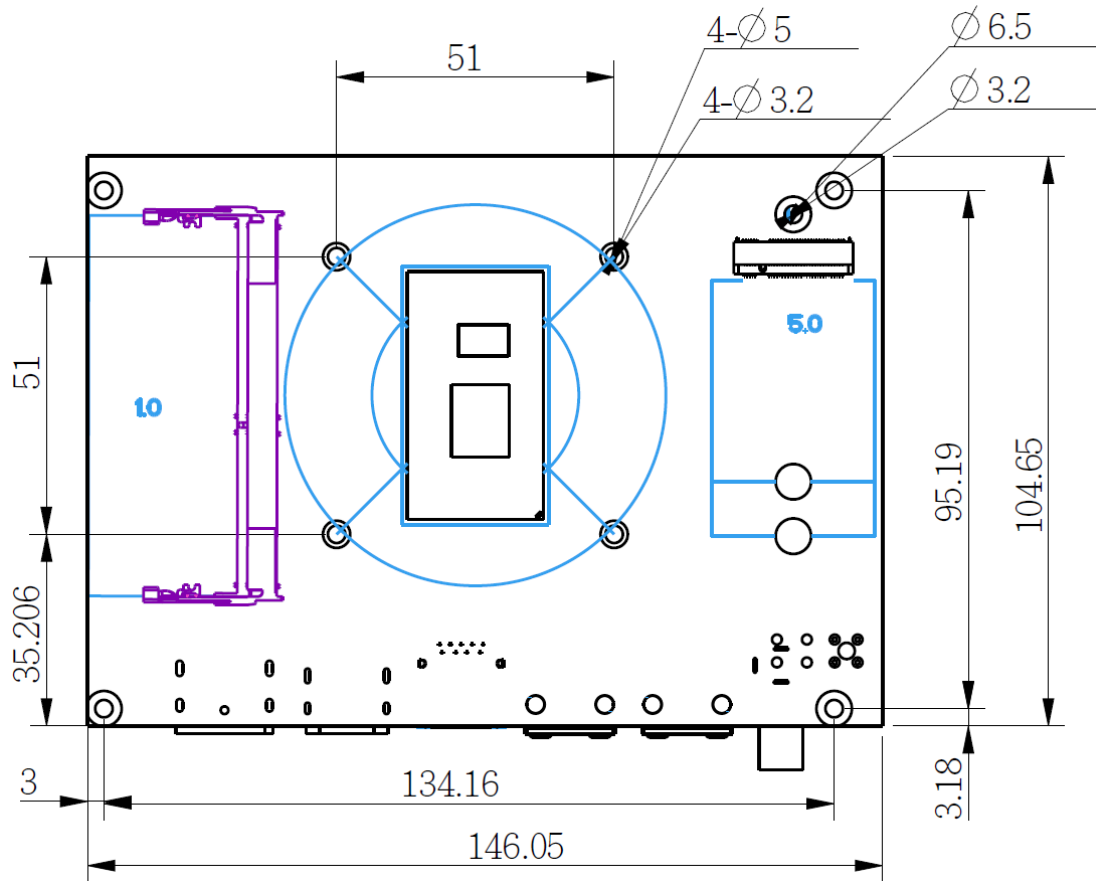

Bottom View

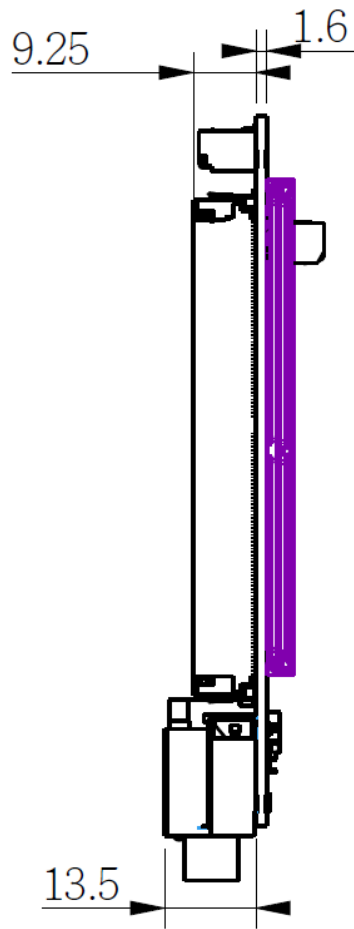

Side View

2.2 Board Layout

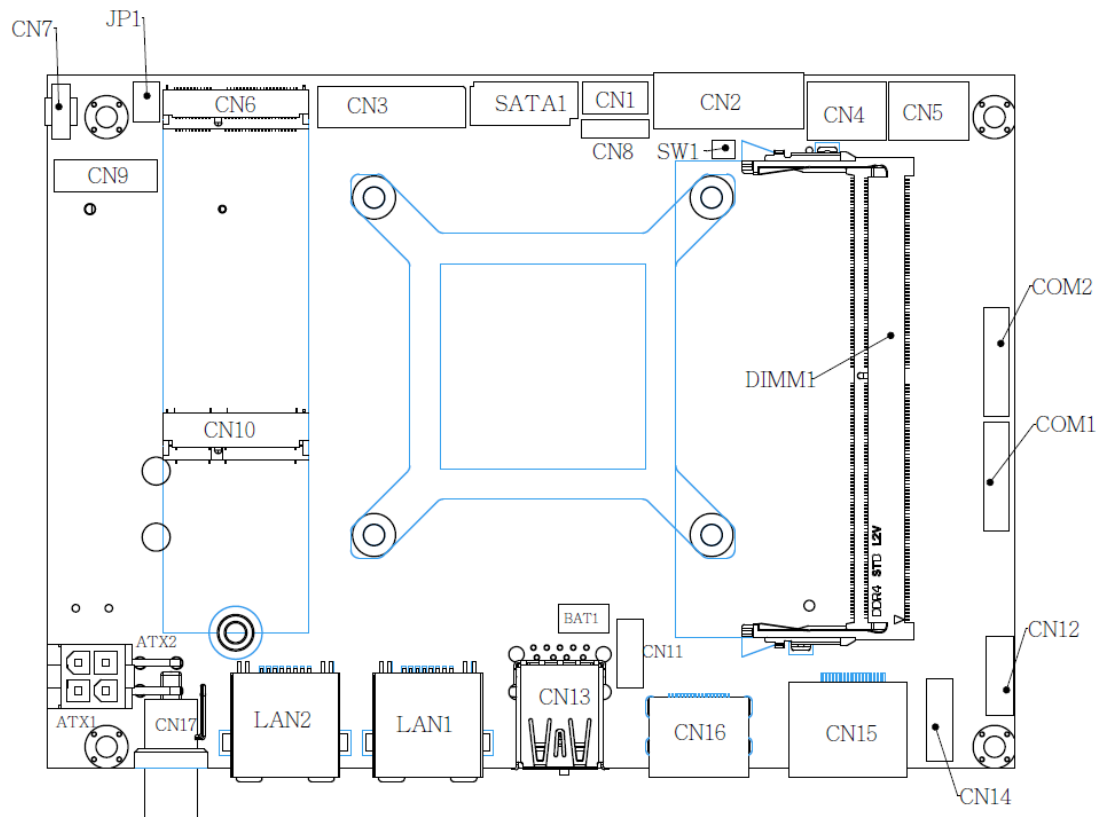

Top View

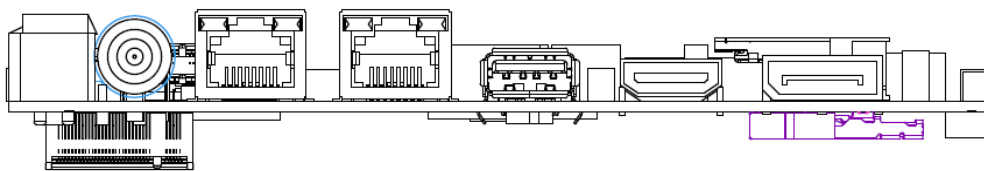

Side View

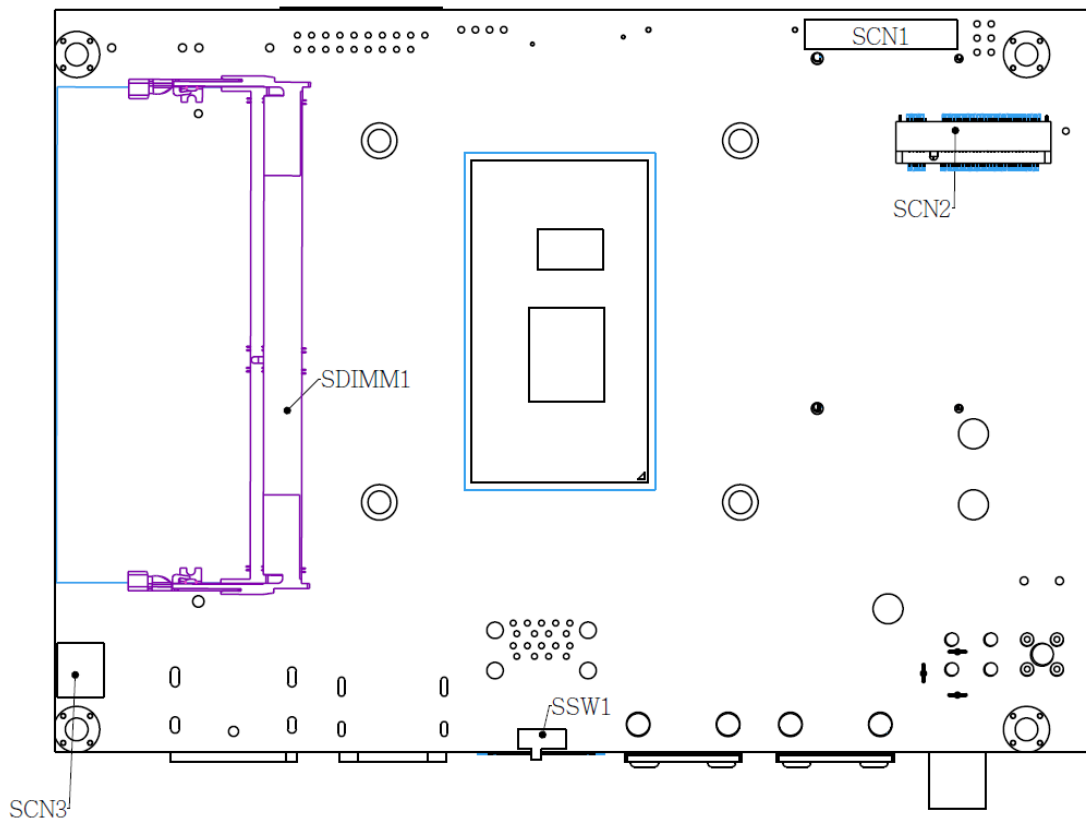

Bottom View

2.3 Installing Thermal Solution

2.3.1 Installing Cooling Fan

Image below illustrates how to install cooling fan on CAPA55R.

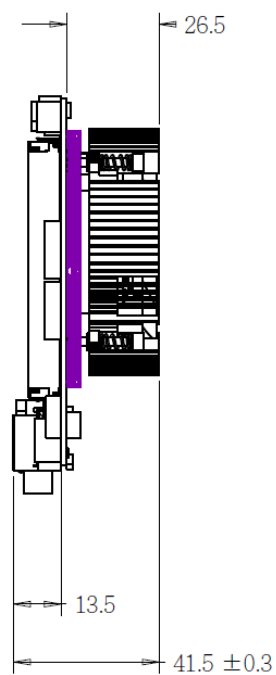
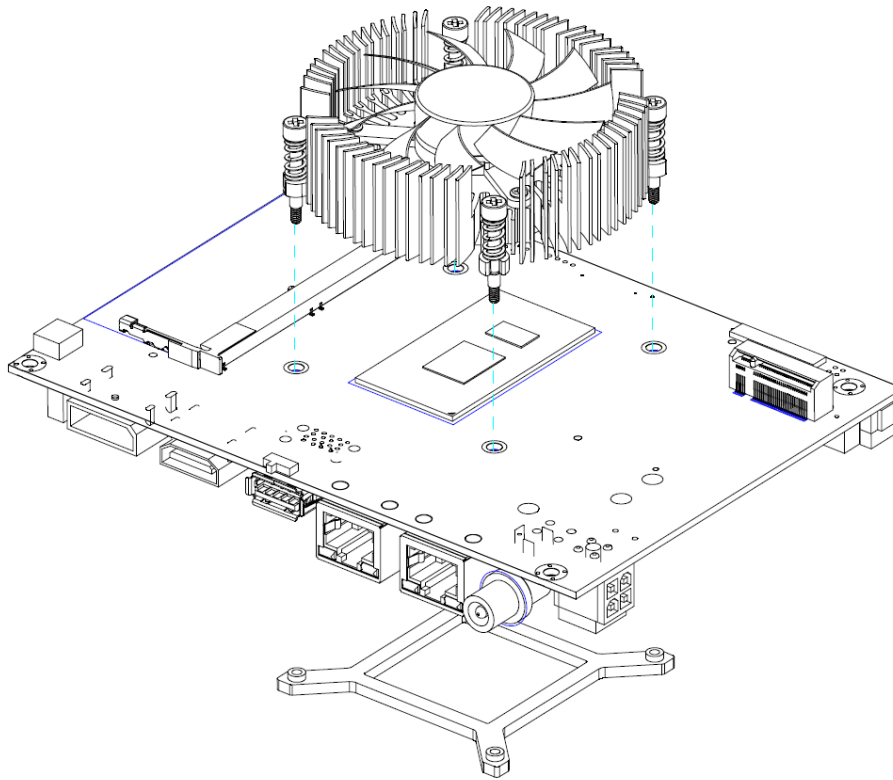

2.3.2 Installing Heatsink

A properly installed heatsink is very important to ensure that excess heat is efficiently dissipated and temperature is maintained within safe operating range. Image below illustrates how to install heatsink on CAPA55R. Be careful not to over-tighten the screws.

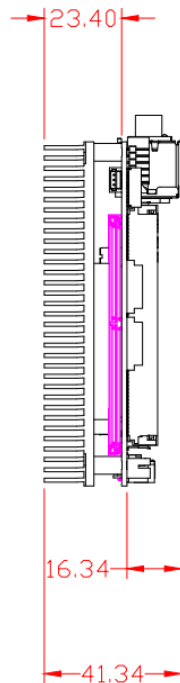
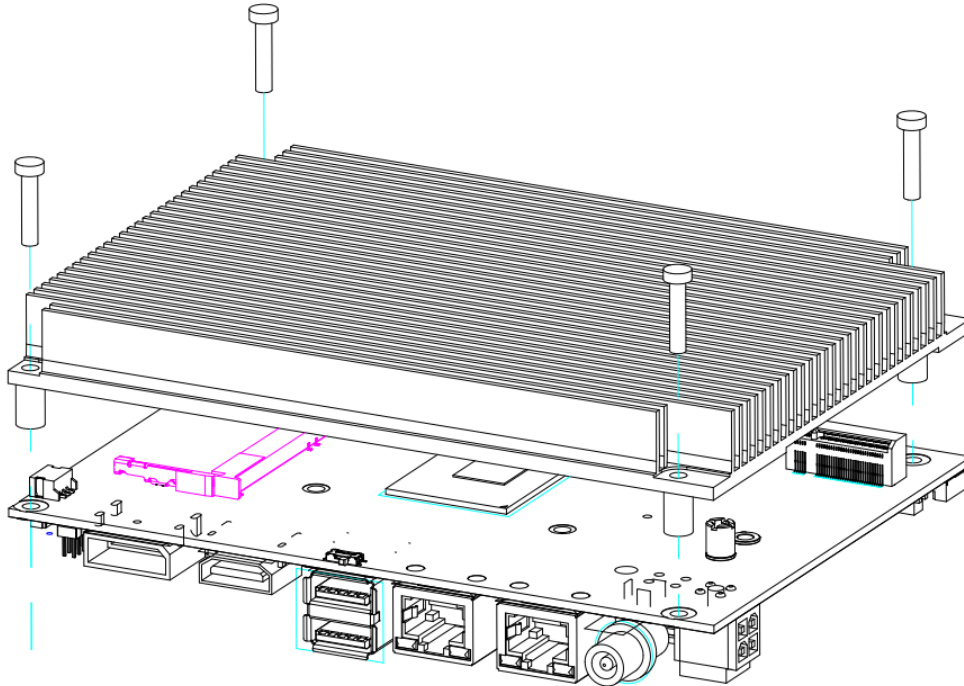

2.4 Installing M.2 2230 Key E and M.2 2280 Key M

Image below illustrates how to install M.2 2230 Key E (CN10) and M.2 2280 Key M (CN6).

M.2 2230 Key E card only:

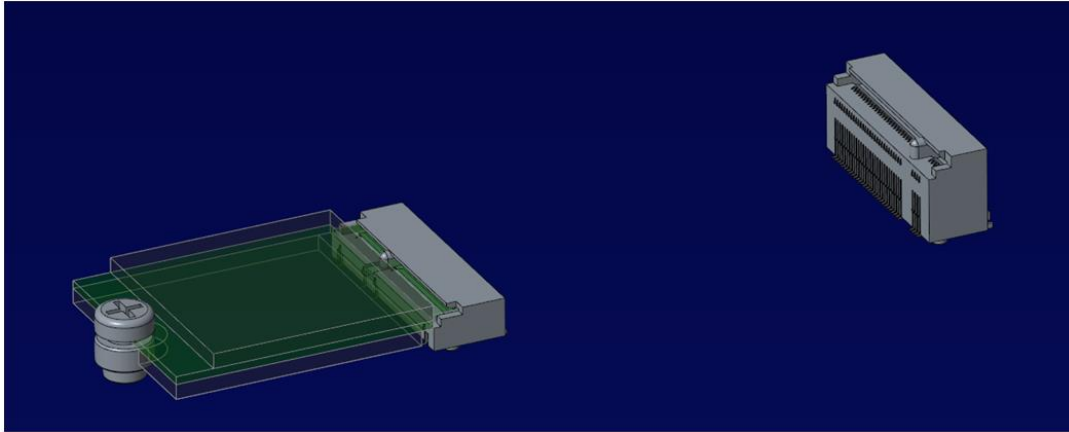

M.2 2280 Key M card only:

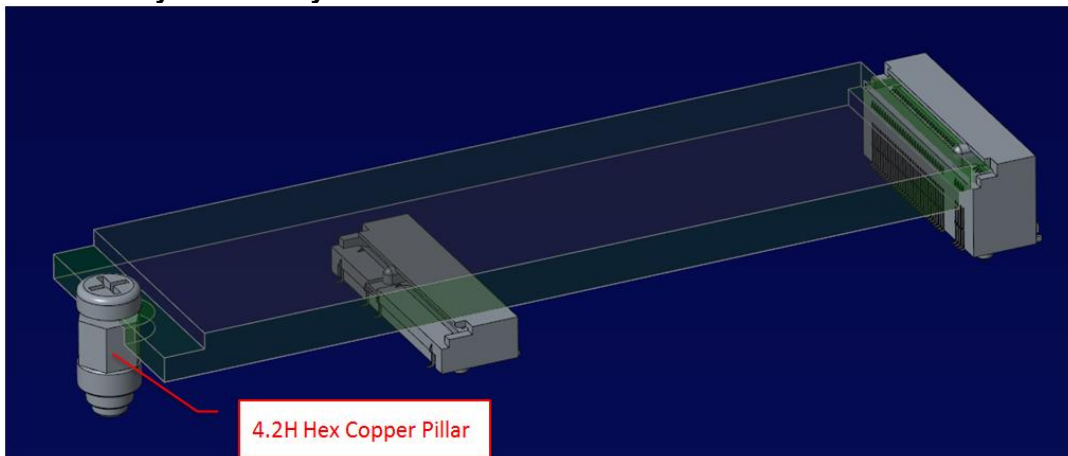

M.2 2230 Key E card + M.2 2280 Key M card:

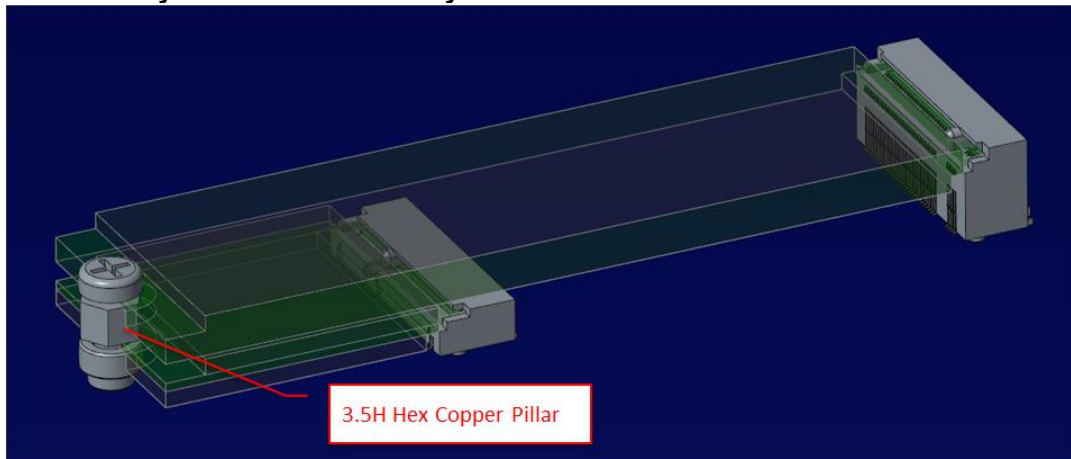

2.5 Jumper and Switch Settings

Jumper is a small component consisting of jumper clip and jumper pins. Install jumper clip on 2 jumper pins to close. And remove jumper clip from 2 jumper pins to open. Below illustration shows how to set up jumper.

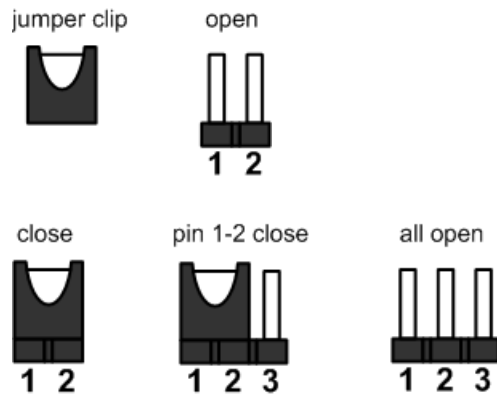

Properly configure jumper and switch settings on the CAPA55R to meet your application purpose. Below you can find a summary table of jumper, switch and onboard default settings.



Note

Once the default jumper or switch setting needs to be changed, please do it under power-off condition.

Jumper and Switch	Description	Setting
JP1	LVDS/eDP Voltage Selection Default: +3.3V Level	1-2 Close
SW1	Restore BIOS Optimal Defaults Default: Normal Operation	Release
SSW1	Auto Power On Default: Disable	1-2 Close

2.5.1 LVDS/eDP Voltage Selection (JP1)

This is a 2x3-pin (pitch=2.0mm) jumper. The board supports voltage selection for flat panel displays. Use JP1 to set LVDS/eDP connector (CN3/SCN1) VCCM pin to +3.3V, +5V or +12V voltage level. To prevent hardware damage, before connecting please make sure that input voltage of the flat panel is correct.

Function	Setting
+3.3V level (Default)	1-2 close
+5V level	2-4 close Or 4-6 close
+12V level	5-6 close

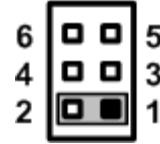

2.5.2 Restore BIOS Optimal Defaults (SW1)

Use SW1 to clear CMOS. Press the tact switch for at least 1 second to restore BIOS optimal defaults.

Function	Setting
Normal (Default)	Release
Restore BIOS optimal defaults	Press

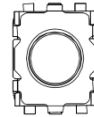

2.5.3 Auto Power On (SSW1)

If SSW1 is enabled for power input, the system will be automatically power on without pressing soft power button. If SSW1 is disabled for power input, it is necessary to manually press soft power button to power on the system.

Function	Setting
Disable auto power on (Default)	1-2 close
Enable auto power on	2-3 close

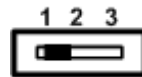

2.6 Connectors

Signals go to other parts of the system through connectors. Loose or improper connection might cause problems, please make sure all connectors are properly and firmly connected. Here is a summary table of connectors on the hardware.

Connector	Description
CN1	SATA Power Connector
CN2	USB 3.2 Gen2 Wafer Connector
CN3	LVDS Connector
CN4, CN5	USB 2.0 Wafer Connectors
CN6	M.2 Key M Connector
CN7	SIM Card Wafer Connector
CN8	HD Audio Interface Wafer Connector
CN9	Inverter Connector
CN10	M.2 Key E Connector
CN11	I ² C Connector
CN12	Digital I/O Wafer Connector
CN14	Front Panel Connector
CN15	DisplayPort++ Connector
CN16	HDMI Connector
CN17/ATX1/ATX2	Power Connector
COM1, COM2	COM1 and COM2 Wafer Connectors
SATA1	SATA Connector
LAN1, LAN2	Ethernet Port 1 and 2
CN13/USB1	USB 3.2 Gen2 Type A Port (co-layout with USB1)
BAT1	CMOS Battery Connector
SCN1	eDP Connector
SCN2	M.2 Key B Connector
SCN3	Fan Connector
DIMM1	DDR4 SO-DIMM Connector
SDIMM1	DDR4 SO-DIMM Connector

2.6.1 SATA Power Connector (CN1)

This is a 4-pin (pitch=2mm) wafer connector, which is compliant with JST B4B-PH-K-S, for SATA power interface.

Pin	Signal
1	+12V
2	GND
3	GND
4	+5V

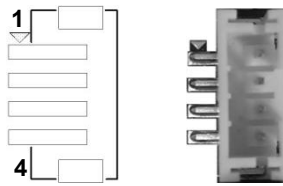

2.6.2 USB 3.2 Gen2 Wafer Connector (CN2)

This is a 2x10 19-pin (pitch=2mm) wafer connector for installing versatile USB peripherals such as keyboard, mouse, scanner, etc.; which is also compatible with USB 3.2 devices.

Pin	Signal	Pin	Signal
1	USB VCC (+5V_SBY)		
2	USB3_RX3_N	19	USB VCC (+5V_SBY)
3	USB3_RX3_P	18	USB3_RX4_N
4	GND	17	USB3_RX4_P
5	USB3_TX3_N	16	GND
6	USB3_TX3_P	15	USB3_TX4_N
7	GND	14	USB3_TX4_P
8	USB_D3_N	13	GND
9	USB_D3_P	12	USB_D4_N
10	N.C	11	USB_D4_P

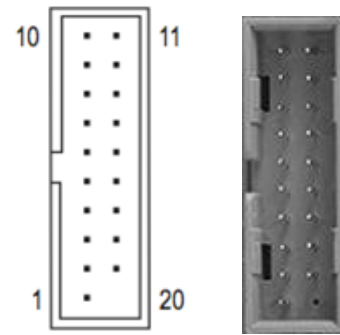

2.6.3 LVDS Connector (CN3)

This is a 2x20-pin (pitch=1.0mm) connector which is compliant with JST SM40B-SRDS-G-TF for LVDS LCD interface. It is strongly recommended to connect it with matching connector, SHDR-40VS-B. Pin 1~6 VCCM can be set to +3.3V, +5V or +12V by setting JP1 (see section 2.5.1).



Note

[*]: When making LVDS cable, pin 2 of JST SHDR-40VS-B connector should match pin 1 of CN3.

18-bit single channel

Pin	Signal	Pin	Signal
1	VCCM	2	VCCM
3	VCCM	4	VCCM
5	VCCM	6	VCCM
7	N.C	8	N.C
9	GND	10	GND
11	N.C	12	N.C
13	N.C	14	N.C
15	GND	16	GND
17	N.C	18	N.C
19	N.C	20	N.C
21	GND	22	GND
23	Channel A D0-	24	N.C
25	Channel A D0+	26	N.C
27	GND	28	GND
29	Channel A D1-	30	N.C
31	Channel A D1+	32	N.C
33	GND	34	GND
35	Channel A D2-	36	Channel A CLK-
37	Channel A D2+	38	Channel A CLK+
39	GND	40	GND

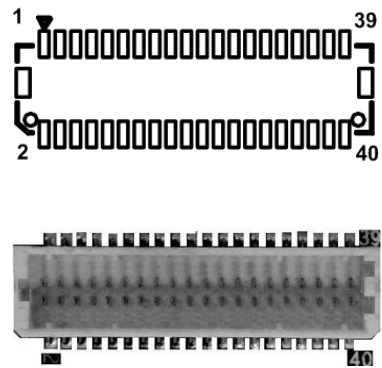

24-bit single channel

Pin	Signal	Pin	Signal
1	VCCM	2	VCCM
3	VCCM	4	VCCM
5	VCCM	6	VCCM
7	N.C	8	N.C
9	GND	10	GND
11	N.C	12	N.C
13	N.C	14	N.C
15	GND	16	GND
17	N.C	18	N.C
19	N.C	20	N.C
21	GND	22	GND
23	Channel A D0-	24	N.C
25	Channel A D0+	26	N.C
27	GND	28	GND
29	Channel A D1-	30	Channel A D3-
31	Channel A D1+	32	Channel A D3+
33	GND	34	GND
35	Channel A D2-	36	Channel A CLK-
37	Channel A D2+	38	Channel A CLK+
39	GND	40	GND

18-bit dual channel

Pin	Signal	Pin	Signal
1	VCCM	2	VCCM
3	VCCM	4	VCCM
5	VCCM	6	VCCM
7	N.C	8	N.C
9	GND	10	GND
11	N.C	12	Channel B D0-
13	N.C	14	Channel B D0+
15	GND	16	GND
17	Channel B CLK-	18	Channel B D1-
19	Channel B CLK+	20	Channel B D1+
21	GND	22	GND
23	Channel A D0-	24	Channel B D2-
25	Channel A D0+	26	Channel B D2+
27	GND	28	GND
29	Channel A D1-	30	N.C
31	Channel A D1+	32	N.C
33	GND	34	GND
35	Channel A D2-	36	Channel A CLK-
37	Channel A D2+	38	Channel A CLK+
39	GND	40	GND

24-bit dual channel

Pin	Signal	Pin	Signal
1	VCCM	2	VCCM
3	VCCM	4	VCCM
5	VCCM	6	VCCM
7	N.C	8	N.C
9	GND	10	GND
11	Channel B D3-	12	Channel B D0-
13	Channel B D3+	14	Channel B D0+
15	GND	16	GND
17	Channel B CLK-	18	Channel B D1-
19	Channel B CLK+	20	Channel B D1+
21	GND	22	GND
23	Channel A D0-	24	Channel B D2-
25	Channel A D0+	26	Channel B D2+
27	GND	28	GND
29	Channel A D1-	30	Channel A D3-
31	Channel A D1+	32	Channel A D3+
33	GND	34	GND
35	Channel A D2-	36	Channel A CLK-
37	Channel A D2+	38	Channel A CLK+
39	GND	40	GND

2.6.4 USB 2.0 Wafer Connectors (CN4 and CN5)

These are 2x5-pin (pitch=2mm) wafer connectors, which are compliant with Hirose DF11-XDP-2DSA, for installing versatile USB 2.0 compliant interface peripherals.

CN4:

Pin	Signal	Pin	Signal
1	USB VCC (+5V_SBY)	2	USB VCC (+5V_SBY)
3	USB_D7_N	4	USB_D8_N
5	USB_D7_P	6	USB_D8_P
7	GND	8	GND
9	GND	10	GND

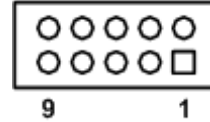

CN5:

Pin	Signal	Pin	Signal
1	USB VCC (+5V_SBY)	2	USB VCC (+5V_SBY)
3	USB_D5_N	4	USB_D6_N
5	USB_D5_P	6	USB_D6_P
7	GND	8	GND
9	GND	10	GND

2.6.5 M.2 Key M Connector (CN6)

The CN6 is a M.2 2280 Key M connector recommended for installing storage card.

Pin	Signal	Pin	Signal
1	GND	2	+3.3V
3	GND	4	+3.3V
5	PEG_PCIE_RX3_N	6	NC
7	PEG_PCIE_RX3_P	8	NC
9	GND	10	NC
11	PEG_PCIE_TX3_N	12	+3.3V
13	PEG_PCIE_TX3_P	14	+3.3V
15	GND	16	+3.3V
17	PEG_PCIE_RX2_N	18	+3.3V
19	PEG_PCIE_RX2_P	20	NC
21	GND	22	NC
23	PEG_PCIE_TX2_N	24	NC
25	PEG_PCIE_TX2_P	26	NC
27	GND	28	NC
29	PEG_PCIE_RX1_N	30	NC
31	PEG_PCIE_RX1_P	32	NC
33	GND	34	NC
35	PEG_PCIE_TX1_N	36	NC
37	PEG_PCIE_TX1_P	38	NC
39	GND	40	NC
41	PEG_PCIE_RX0_N	42	NC
43	PEG_PCIE_RX0_P	44	NC
45	GND	46	NC
47	PEG_PCIE_TX0_N	48	NC
49	PEG_PCIE_TX0_P	50	PERST#
51	GND	52	CLKREQ#
53	REF_CLK_N	54	PEWAKE#
55	REF_CLK_P	56	NC
57	GND	58	NC
59	Key M	60	Key M
61		62	
63		64	
65		66	
67	NC	68	NC
69	NC	70	+3.3V
71	GND	72	+3.3V
73	GND	74	+3.3V
75	GND		

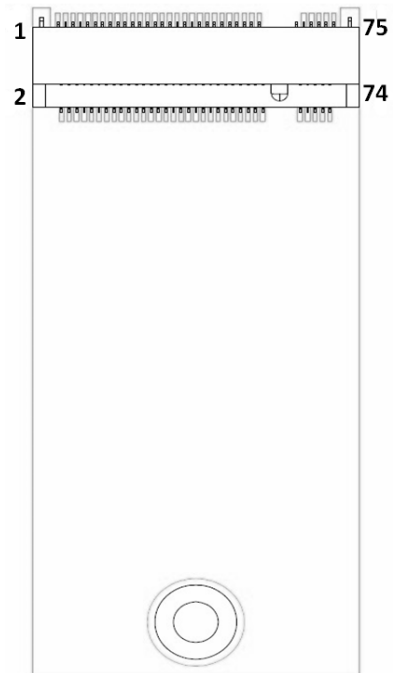

Note

^[1]: The CN6 supports PCIe Gen4 x4 NVMe-based SSD.

2.6.6 SIM Card Wafer Connector (CN7)

The CN7 is a 6-pin (pitch=1.0mm) wafer connector, which is compliant with JST B6B-PH-K-S, for SIM Card interface. You are suggested to use AX93A19 for CN7 to have SIM card slot.

In order to work properly, the SIM card must be used together with 3G/4G/5G module in M.2 Key B connector (SCN2). It is mainly used in 3G/4G/5G cellular network application.

Pin	Signal
1	SIM_PWR
2	SIM_RESET
3	SIM_CLK
4	SIM_DAT
5	VPP
6	GND

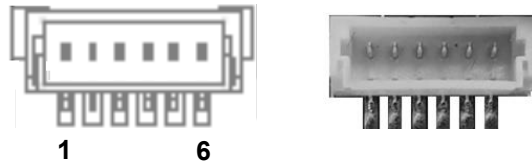

2.6.7 HD Audio Interface Wafer Connector (CN8)

This is an 8-pin (pitch=1.0mm) wafer connector, which is compliant with JST BM08B-SRSS-TB, for HD audio interface.

It is suggested to connect AX93A22 to have Mic in/Line in and Line out.

Pin	Signal
1	+5V_SBY
2	HD_BIT_CLK
3	HD_DATA_IN
4	HD_DATA_OUT
5	HD_SYNC
6	HD_RST#
7	SLP_S3#
8	GND

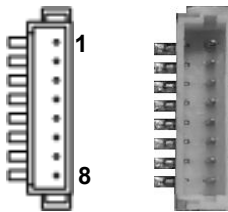

2.6.8 Inverter Connector (CN9)

This is an 8-pin (pitch=1.25mm) connector fully compliant with Hirose DF13-8P-1.25V for inverter. We strongly recommend you to use the matching connector, DF13-8S-1.25C, in order to avoid malfunction.

Pin	Signal
1	VBL1 (+12V level)
2	VBL1 (+12V level)
3	VBL2 (+5V level)
4	VBL_ENABLE
5	GND
6	GND
7	GND
8	VBL Brightness Control

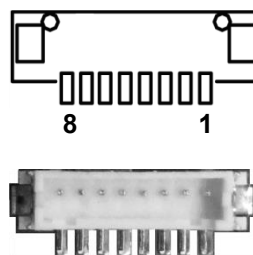

2.6.9 M.2 Key E Connector (CN10)

The CN10 is a M.2 2230 Key E connector. It is suggested to install the M.2 wireless module via PCIe x1 and USB 2.0 with 22mm width and 30mm length.

Pin	Signal	Pin	Signal
1	GND	2	+3.3V_SBY
3	USB_D9_P	4	+3.3V_SBY
5	USB_D9_N	6	NC
7	GND	8	NC
9	NC	10	NC
11	NC	12	NC
13	NC	14	NC
15	NC	16	NC
17	NC	18	GND
19	NC	20	NC
21	NC	22	NC
23	NC	24	Key E
25	Key E	26	
27		28	
29		30	
31		32	
33		GND	34
35	PCIE_TX_P	36	NC
37	PCIE_TX_N	38	NC
39	GND	40	NC
41	PCIE_RX_P	42	NC
43	PCIE_RX_N	44	NC
45	GND	46	NC
47	PCIE_CLK_P	48	NC
49	PCIE_CLK_N	50	NC
51	GND	52	PERST#(+3.3V)
53	CLK_REQ3	54	W_DIS2#(+3.3V)
55	PEWAKE0#	56	W_DI12#(+3.3V)
57	GND	58	NC
59	NC	60	NC
61	NC	62	NC
63	GND	64	NC
65	NC	66	NC
67	NC	68	NC
69	GND	70	NC
71	NC	72	+3.3V_SBY
73	NC	74	+3.3V_SBY
75	GND		

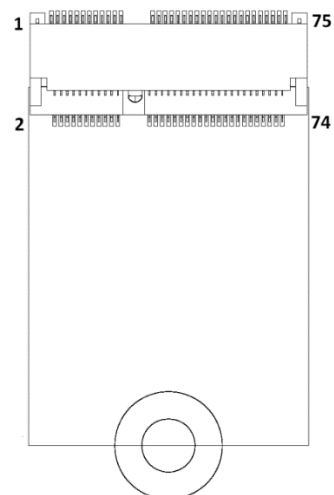

2.6.10 I²C Connector (CN11)

This is a 4-pin (pitch=1.25mm) connector for I²C interface which is compatible with SMBus.

Pin	Signal
1	I ² C _CLK
2	I ² C _DATD
3	I ² C _ALERT_N
4	GND



2.6.11 Digital I/O Wafer Connector (CN12)

This is a 1x10-pin (pitch=1.0mm) wafer connector fully compliant with JST BM10B-SRSS-TB. This 8-channel digital I/O meets requirements for a system customary automation control. The digital I/O can be configured to control cash drawers and sense warning signals from an Uninterrupted Power System (UPS), or perform store security control. You may use software programming to control these digital signals, please refer to Appendix B.

Pin	Signal
1	DIO 0
2	DIO 1
3	DIO 2
4	DIO 3
5	DIO 4
6	DIO 5
7	DIO 6
8	DIO 7
9	+5V
10	GND

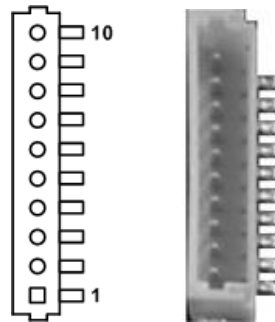

2.6.12 Front Panel Connector (CN14)

This is a 2x6-pin header (pitch=2.0mm) for front panel interface.

Pin	Signal	Pin	Signal
1	BUZZER-	2	BUZZER+
3	GND	4	PWR_PSON
5	PWRLED-	6	PWRLED+
7	PWRSW-	8	PWRSW+
9	HW RST-	10	HW RST+
11	HDDLED-	12	HDDLED+

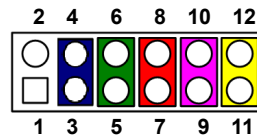

Internal Buzzer

Pin 1(-) and 2(+) connect the internal buzzer cable.

Power Status (PS-ON)

Pin 4 and pin 3 are PS-ON signal which are connected for knowing the power status of this board.

Power LED

Pin 6 connects anode (+) of LED and pin 5 connects cathode(-) of LED. The power LED lights up when the system is powered on.

Power On/Off Button

Pin 7 and 8 connect the power button on front panel to CPU board, which allows users to turn on or off power.

System Reset Switch

Pin 9 and 10 connect the case-mounted reset switch that reboots your computer without turning off the power switch. It is a better way to reboot your system for a longer life of system power supply.

HDD Activity LED

This connection is linked to hard drive activity LED on the control panel. LED flashes when HDD is being accessed. Pin 11 and 12 connect the hard disk drive to the front panel HDD LED, pin 11 is assigned as cathode(-) and pin 12 is assigned as anode(+).

2.6.13 DisplayPort++ Connector (CN15)

The DisplayPort++ interface is available through connector CN15.

Pin	Signal
1	DP_LANE0P
2	GND
3	DP_LANE0_N
4	DP_LANE1_P
5	GND
6	DP_LANE1_N
7	DP_LANE2_P
8	GND
9	DP_LANE2_N
10	DP_LANE3_P
11	GND
12	DP_LANE3_N
13	Detect Pin
14	GND
15	DP_AUX_P
16	GND
17	DP_AUX_N
18	DP_HPDE
19	GND
20	+3.3V

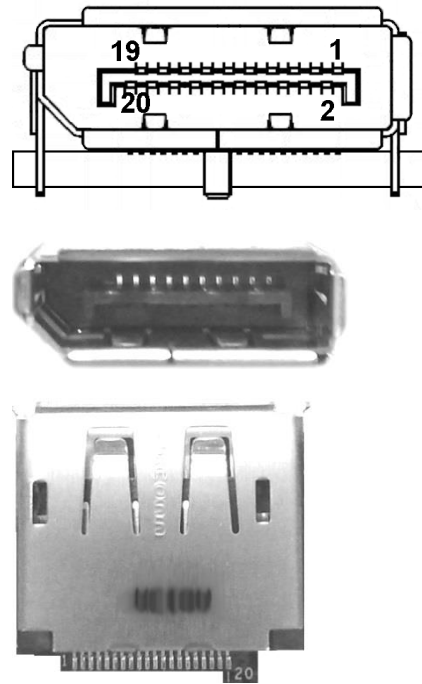

2.6.14 HDMI Connector (CN16)

The HDMI (High-Definition Multimedia Interface) is a compact digital interface which is capable of transmitting high-definition video and high-resolution audio over a single cable.

Pin	Signal	Pin	Signal
1	HDMI OUT_D2_P	2	GND
3	HDMI OUT_D2_N	4	HDMI OUT_D1_P
5	GND	6	HDMI OUT_D1_N
7	HDMI OUT_D0_P	8	GND
9	HDMI OUT_D0_N	10	HDMI OUT_CLK_P
11	GND	12	HDMI OUT_CLK_N
13	N.C.	14	N.C.
15	HDMI OUT_SCL	16	HDMI OUT_SDA
17	GND	18	+5V
19	HDMI_HTPLG		

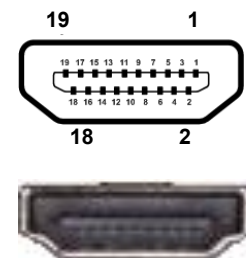

2.6.15 Power Connector (CN17/ATX1/ATX2)

Steady and sufficient power can be supplied to all components on the board by connecting the power connector. Please make sure all components and devices are properly installed before connecting the power connector.

The CN17 is a DC jack power connector with screw. Loose connection may cause system instability.

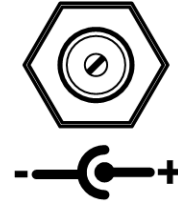

The ATX1/ATX2 is a 4-pin power input interface. Follow the connector orientation to plug the external power supply. Properly press down power supply plug until it completely and firmly fits into this connector. Loose connection may cause system instability.

Pin	Signal
1	GND
2	GND
3	DC-In
4	DC-In

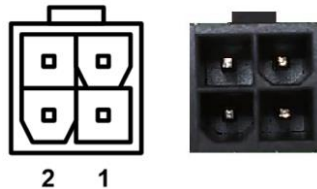

2.6.16 COM Wafer Connectors (COM1 and COM2)

This is a 9-pin (pitch=1.25mm) connector which is compliant with Molex 53047-0910. Both COM1 and COM2 support RS-232/422/485 by BIOS selecting (see section 4.4). The pin assignments of RS-232/422/485 are listed in table below. It is strongly recommended to connect with the matching cable, 59380880250E.

Pin	RS-232	RS-422	RS-485
1	DCD	TX-	Data-
2	DSR	No use	No use
3	RXD	TX+	Data+
4	RTS	No use	No use
5	TXD	RX+	No use
6	CTS	No use	No use
7	DTR	RX-	No use
8	RI	No use	No use
9	GND	GND	GND

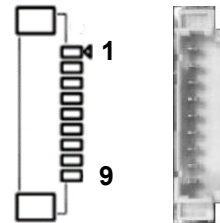

2.6.17 SATA Connector (SATA1)

This Serial Advanced Technology Attachment (Serial ATA or SATA) connector is for high-speed SATA interface. It is a computer bus interface for connecting to devices such as hard disk drive.

Pin	Signal
1	GND
2	SATA_0_TX_P
3	SATA_0_TX_N
4	GND
5	SATA_0_RX_N
6	SATA_0_RX_P
7	GND

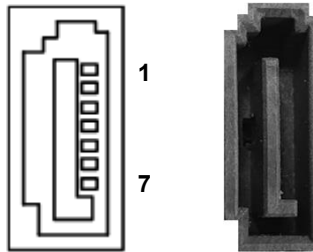

2.6.18 Ethernet Ports (LAN1 and LAN2)

The board has two RJ-45 Ethernet connectors. Connection can be established by plugging one end of the Ethernet cable into LAN1 and the other end (phone jack) to a 2500/1000/100/10-Base-T hub. Connection can be established by plugging one end of the Ethernet cable into LAN2 and the other end (phone jack) to a 1000/100/10-Base-T hub.

Pin	1000 Base-T	100/10 Base-T	Description
L1	BI_DA+	TX+	Bidirectional or Transmit Data+
L2	BI_DA-	TX-	Bidirectional or Transmit Data-
L3	BI_DB+	RX+	Bidirectional or Receive Data+
L4	BI_DC+	N.C.	Bidirectional or Not Connected
L5	BI_DC-	N.C.	Bidirectional or Not Connected
L6	BI_DB-	RX-	Bidirectional or Receive Data-
L7	BI_DD+	N.C.	Bidirectional or Not Connected
L8	BI_DD-	N.C.	Bidirectional or Not Connected
A	Active Link LED Off: No link Blinking: Data activity detected		
B	Speed LED Green: 2500 (for LAN1), 100 (for LAN2) Orange: 1000 OFF: 100/10 (for LAN1), 10 (for LAN2)		

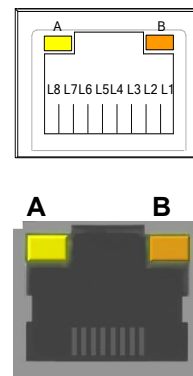

2.6.19 USB 3.2 Gen2 Type A Port (CN13/USB1)

The board comes with one Universal Serial Bus (compliant with USB 3.2 Gen 2 (10Gb/s)) ports on the rear I/O for installing USB peripherals such as keyboard, mouse, scanner, etc.

The CN13 is co-layout with USB1:

- For single stack requirement, connector CN13 is mounted and M.2 Key B (SCN2) supports USB 3.0.
- For double stack requirement, connector USB1 is mounted and M.2 Key B (SCN2) does not support USB 3.0.

CN13:

Pin	Signal
1	USB_VCC (+5V)
2	USB_D1_N
3	USB_D1_P
4	GND
5	USB3_RX1_N
6	USB3_RX1_P
7	GND
8	USB3_TX1_N
9	USB3_TX1_P

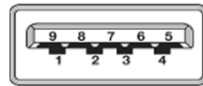

USB1 (Optional):

Pin	Signal	Pin	Signal
1	USB_VCC (+5V)	10	USB_VCC (+5V)
2	USB_D1_N	11	USB_D2_N
3	USB_D1_P	12	USB_D2_P
4	GND	13	GND
5	USB3_RX1_N	14	USB3_RX2_N
6	USB3_RX1_P	15	USB3_RX2_P
7	GND	16	GND
8	USB3_TX1_N	17	USB3_TX2_N
9	USB3_TX1_P	18	USB3_TX2_P

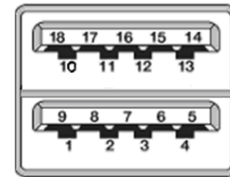

2.6.20 CMOS Battery Connector (BAT1)

This is a 2-pin (pitch=1.25mm) wafer connector for CMOS battery interface.

Pin	Signal
1	BAT1(+3V level)
2	GND



2.6.21 eDP Connector (SCN1)

The embedded DisplayPort (eDP) interface is available through 30-pin connector (IPEX-20453-030T-01), which is compliant with I-PEX-CABLINE II HT1 20143.

Pin	Signal	Pin	Signal
1	N/C	2	VCC_BKLT
3	VCC_BKLT	4	VCC_BKLT
5	VCC_BKLT	6	N/C
7	N/C	8	BKLT_CTL
9	BKLT_EN	10	GND
11	GND	12	GND
13	GND	14	EMB_HPD
15	GND	16	GND
17	BIST	18	VCCM ^[*]
19	VCCM ^[*]	20	GND
21	EMB_AUX_N	22	EMB_AUX_P
23	GND	24	EDP_TX0_P
25	EDP_TX0_N	26	GND
27	EDP_TX1_P	28	EDP_TX1_N
29	GND	30	N/C

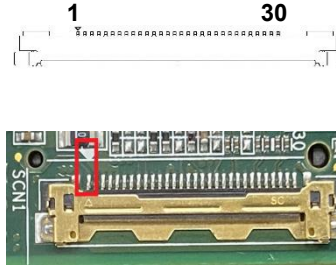

Note

- eDP connector P/N: All Link, 282A-3000-10R0-G3

^[*] Panel power VCCM is +3.3V by default, +5V or 12V is selectable by jumper JP1, see section 2.5.1.

2.6.22 M.2 Key B Connector (SCN2)

The SCN2 is a M.2 Key B connector. It is suggested to install the M.2 cellular module with 30mm width and 42mm length or 30mm width and 50/52mm length.

Pin	Signal	Pin	Signal
1	CONFIG_3	2	+3.3V_SBY
3	GND	4	+3.3V_SBY
5	GND	6	Full Card PWR OFF
7	USB_D10_P	8	W_DISABLE#
9	USB_D10_N	10	NC
11	GND	12	Key B
13	Key B	14	
15		16	
17		18	
19		20	NC
21	CONFIG_0	22	NC
23	GPIO11(+1.8V)	24	NC
25	NC	26	NC
27	GND	28	NC
29	USB3_RX2_N	30	SIM_RESET
31	USB3_RX2_P	32	SIM_CLK
33	GND	34	SIM_DATA
35	USB3_TX2_N	36	SIM_PWR
37	USB3_TX2_P	38	NC
39	GND	40	SMB_CLK_SBY(+1.8V)
41	PCIE_RX_N	42	SMB_DATA_SBY(+1.8V)
43	PCIE_RX_P	44	NC
45	GND	46	NC
47	PCIE_TX_N	48	NC
49	PCIE_TX_P	50	PERST#
51	GND	52	CLK_REQ4
53	PCIE_CLK4_N	54	PEWAKE#
55	PCIE_CLK4_P	56	NC
57	GND	58	NC
59	NC	60	NC
61	NC	62	NC
63	NC	64	NC
65	NC	66	NC
67	PLTRST(+1.8V)	68	SUSCLK
69	CONFIG_1	70	+3.3V_SBY
71	GND	72	+3.3V_SBY
73	GND	74	+3.3V_SBY
75	CONFIG_2		



2.6.23 Fan Connector (SCN3)

This is a 3-pin (pitch=1.5mm) connector for fan interface.

Pin	Signal
1	GND
2	+12V level
3	Fan speed feedback

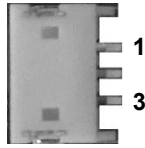

1 3

This page is intentionally left blank.

Section 3

Hardware Description

3.1 Microprocessors

The CAPA55R supports 11th Generation Intel® Core™ i7/ i5/ i3 and Celeron® processor which enables your system to operate under Windows® 10 and Linux environments. The system performance depends on the microprocessor. Make sure all correct settings are arranged for the installed microprocessor to prevent the CPU from damages.

3.2 BIOS

The CAPA55R uses AMI Plug and Play BIOS with a single 256Mbit SPI Flash.

3.3 System Memory

































































































The CAPA55R supports two 260-pin DDR4 SO-DIMM sockets. The memory module comes in sizes of 4GB, 8GB and 16GB.









































3.4 I/O Port Address Map

Address Range	Device Name
[0000000000000000 - 000000000000CF7]	PCI Express Root Complex
[0000000000000020 - 0000000000000021]	Programmable interrupt controller
[0000000000000024 - 0000000000000025]	Programmable interrupt controller
[0000000000000028 - 0000000000000029]	Programmable interrupt controller
[000000000000002C - 000000000000002D]	Programmable interrupt controller
[000000000000002E - 000000000000002F]	Motherboard resources
[0000000000000030 - 0000000000000031]	Programmable interrupt controller
[0000000000000034 - 0000000000000035]	Programmable interrupt controller
[0000000000000038 - 0000000000000039]	Programmable interrupt controller
[000000000000003C - 000000000000003D]	Programmable interrupt controller
[0000000000000040 - 0000000000000043]	System timer
[000000000000004E - 000000000000004F]	Motherboard resources
[0000000000000050 - 0000000000000053]	System timer
[0000000000000060 - 0000000000000060]	Standard PS/2 Keyboard
[0000000000000061 - 0000000000000061]	Motherboard resources
[0000000000000062 - 0000000000000062]	Microsoft ACPI-Compliant Embedded Controller
[0000000000000063 - 0000000000000063]	Motherboard resources
[0000000000000064 - 0000000000000064]	Standard PS/2 Keyboard
[0000000000000065 - 0000000000000065]	Motherboard resources
[0000000000000066 - 0000000000000066]	Microsoft ACPI-Compliant Embedded Controller
[0000000000000067 - 0000000000000067]	Motherboard resources
[0000000000000070 - 0000000000000070]	Motherboard resources
[0000000000000080 - 0000000000000080]	Motherboard resources
[0000000000000092 - 0000000000000092]	Motherboard resources
[0000000000000A0 - 00000000000000A1]	Programmable interrupt controller
[0000000000000A4 - 00000000000000A5]	Programmable interrupt controller
[0000000000000A8 - 00000000000000A9]	Programmable interrupt controller
[00000000000000AC - 00000000000000AD]	Programmable interrupt controller
[00000000000000B0 - 00000000000000B1]	Programmable interrupt controller
[00000000000000B2 - 00000000000000B3]	Motherboard resources
[00000000000000B4 - 00000000000000B5]	Programmable interrupt controller
[00000000000000B8 - 00000000000000B9]	Programmable interrupt controller
[00000000000000BC - 00000000000000BD]	Programmable interrupt controller
[0000000000000248 - 000000000000024F]	Communications Port (COM1)
[0000000000000258 - 000000000000025F]	Communications Port (COM2)
[00000000000004D0 - 00000000000004D1]	Programmable interrupt controller
[0000000000000680 - 000000000000069F]	Motherboard resources
[0000000000000D00 - 000000000000FFFF]	PCI Express Root Complex
[000000000000164E - 000000000000164F]	Motherboard resources
[0000000000001800 - 00000000000018FE]	Motherboard resources
[0000000000001854 - 0000000000001857]	Motherboard resources
[0000000000002000 - 00000000000020FE]	Motherboard resources
[0000000000003000 - 0000000000003FFF]	Intel(R) PCI Express Root Port #8 - A0BF
[0000000000004000 - 000000000000403F]	Intel(R) Iris(R) Xe Graphics
[0000000000004000 - 000000000000403F]	Intel(R) UHD Graphics
[0000000000004060 - 000000000000407F]	Standard SATA AHCI Controller
[0000000000004080 - 0000000000004083]	Standard SATA AHCI Controller
[0000000000004090 - 0000000000004097]	Standard SATA AHCI Controller
[000000000000EFA0 - 000000000000EFBF]	Intel(R) SMBus - A0A3

3.5 Interrupt Controller (IRQ) Map

The interrupt controller (IRQ) mapping list is shown as follows:

 Interrupt request (IRQ)		 (ISA) 0x00000061 (97) Microsoft ACPI-Compliant System
 (ISA) 0x00000000 (00) System timer		 (ISA) 0x00000062 (98) Microsoft ACPI-Compliant System
 (ISA) 0x00000001 (01) Standard PS/2 Keyboard		 (ISA) 0x00000063 (99) Microsoft ACPI-Compliant System
 (ISA) 0x00000006 (06) Communications Port (COM2)		 (ISA) 0x00000064 (100) Microsoft ACPI-Compliant System
 (ISA) 0x00000007 (07) Communications Port (COM1)		 (ISA) 0x00000065 (101) Microsoft ACPI-Compliant System
 (ISA) 0x0000000E (14) Intel(R) GPIO Controller - 34C5		 (ISA) 0x00000066 (102) Microsoft ACPI-Compliant System
 (ISA) 0x0000001C (28) Trusted Platform Module 2.0		 (ISA) 0x00000067 (103) Microsoft ACPI-Compliant System
 (ISA) 0x00000037 (55) Microsoft ACPI-Compliant System		 (ISA) 0x00000068 (104) Microsoft ACPI-Compliant System
 (ISA) 0x00000038 (56) Microsoft ACPI-Compliant System		 (ISA) 0x00000069 (105) Microsoft ACPI-Compliant System
 (ISA) 0x00000039 (57) Microsoft ACPI-Compliant System		 (ISA) 0x0000006A (106) Microsoft ACPI-Compliant System
 (ISA) 0x0000003A (58) Microsoft ACPI-Compliant System		 (ISA) 0x0000006B (107) Microsoft ACPI-Compliant System
 (ISA) 0x0000003B (59) Microsoft ACPI-Compliant System		 (ISA) 0x0000006C (108) Microsoft ACPI-Compliant System
 (ISA) 0x0000003C (60) Microsoft ACPI-Compliant System		 (ISA) 0x0000006D (109) Microsoft ACPI-Compliant System
 (ISA) 0x0000003D (61) Microsoft ACPI-Compliant System		 (ISA) 0x0000006E (110) Microsoft ACPI-Compliant System
 (ISA) 0x0000003E (62) Microsoft ACPI-Compliant System		 (ISA) 0x0000006F (111) Microsoft ACPI-Compliant System
 (ISA) 0x0000003F (63) Microsoft ACPI-Compliant System		 (ISA) 0x00000070 (112) Microsoft ACPI-Compliant System
 (ISA) 0x00000040 (64) Microsoft ACPI-Compliant System		 (ISA) 0x00000071 (113) Microsoft ACPI-Compliant System
 (ISA) 0x00000041 (65) Microsoft ACPI-Compliant System		 (ISA) 0x00000072 (114) Microsoft ACPI-Compliant System
 (ISA) 0x00000042 (66) Microsoft ACPI-Compliant System		 (ISA) 0x00000073 (115) Microsoft ACPI-Compliant System
 (ISA) 0x00000043 (67) Microsoft ACPI-Compliant System		 (ISA) 0x00000074 (116) Microsoft ACPI-Compliant System
 (ISA) 0x00000044 (68) Microsoft ACPI-Compliant System		 (ISA) 0x00000075 (117) Microsoft ACPI-Compliant System
 (ISA) 0x00000045 (69) Microsoft ACPI-Compliant System		 (ISA) 0x00000076 (118) Microsoft ACPI-Compliant System
 (ISA) 0x00000046 (70) Microsoft ACPI-Compliant System		 (ISA) 0x00000077 (119) Microsoft ACPI-Compliant System
 (ISA) 0x00000047 (71) Microsoft ACPI-Compliant System		 (ISA) 0x00000078 (120) Microsoft ACPI-Compliant System
 (ISA) 0x00000048 (72) Microsoft ACPI-Compliant System		 (ISA) 0x00000079 (121) Microsoft ACPI-Compliant System
 (ISA) 0x00000049 (73) Microsoft ACPI-Compliant System		 (ISA) 0x0000007A (122) Microsoft ACPI-Compliant System
 (ISA) 0x0000004A (74) Microsoft ACPI-Compliant System		 (ISA) 0x0000007B (123) Microsoft ACPI-Compliant System
 (ISA) 0x0000004B (75) Microsoft ACPI-Compliant System		 (ISA) 0x0000007C (124) Microsoft ACPI-Compliant System
 (ISA) 0x0000004C (76) Microsoft ACPI-Compliant System		 (ISA) 0x0000007D (125) Microsoft ACPI-Compliant System
 (ISA) 0x0000004D (77) Microsoft ACPI-Compliant System		 (ISA) 0x0000007E (126) Microsoft ACPI-Compliant System
 (ISA) 0x0000004E (78) Microsoft ACPI-Compliant System		 (ISA) 0x0000007F (127) Microsoft ACPI-Compliant System
 (ISA) 0x0000004F (79) Microsoft ACPI-Compliant System		 (ISA) 0x00000080 (128) Microsoft ACPI-Compliant System
 (ISA) 0x00000050 (80) Microsoft ACPI-Compliant System		 (ISA) 0x00000081 (129) Microsoft ACPI-Compliant System
 (ISA) 0x00000051 (81) Microsoft ACPI-Compliant System		 (ISA) 0x00000082 (130) Microsoft ACPI-Compliant System
 (ISA) 0x00000052 (82) Microsoft ACPI-Compliant System		 (ISA) 0x00000083 (131) Microsoft ACPI-Compliant System
 (ISA) 0x00000053 (83) Microsoft ACPI-Compliant System		 (ISA) 0x00000084 (132) Microsoft ACPI-Compliant System
 (ISA) 0x00000054 (84) Microsoft ACPI-Compliant System		 (ISA) 0x00000085 (133) Microsoft ACPI-Compliant System
 (ISA) 0x00000055 (85) Microsoft ACPI-Compliant System		 (ISA) 0x00000086 (134) Microsoft ACPI-Compliant System
 (ISA) 0x00000056 (86) Microsoft ACPI-Compliant System		 (ISA) 0x00000087 (135) Microsoft ACPI-Compliant System
 (ISA) 0x00000057 (87) Microsoft ACPI-Compliant System		 (ISA) 0x00000088 (136) Microsoft ACPI-Compliant System
 (ISA) 0x00000058 (88) Microsoft ACPI-Compliant System		 (ISA) 0x00000089 (137) Microsoft ACPI-Compliant System
 (ISA) 0x00000059 (89) Microsoft ACPI-Compliant System		 (ISA) 0x0000008A (138) Microsoft ACPI-Compliant System
 (ISA) 0x0000005A (90) Microsoft ACPI-Compliant System		 (ISA) 0x0000008B (139) Microsoft ACPI-Compliant System
 (ISA) 0x0000005B (91) Microsoft ACPI-Compliant System		 (ISA) 0x0000008C (140) Microsoft ACPI-Compliant System
 (ISA) 0x0000005C (92) Microsoft ACPI-Compliant System		 (ISA) 0x0000008D (141) Microsoft ACPI-Compliant System
 (ISA) 0x0000005D (93) Microsoft ACPI-Compliant System		 (ISA) 0x0000008E (142) Microsoft ACPI-Compliant System
 (ISA) 0x0000005E (94) Microsoft ACPI-Compliant System		 (ISA) 0x0000008F (143) Microsoft ACPI-Compliant System
 (ISA) 0x0000005F (95) Microsoft ACPI-Compliant System		 (ISA) 0x00000090 (144) Microsoft ACPI-Compliant System
 (ISA) 0x00000060 (96) Microsoft ACPI-Compliant System		

	(ISA) 0x000001E4 (484)	Microsoft ACPI-Compliant System
	(ISA) 0x000001E5 (485)	Microsoft ACPI-Compliant System
	(ISA) 0x000001E6 (486)	Microsoft ACPI-Compliant System
	(ISA) 0x000001E7 (487)	Microsoft ACPI-Compliant System
	(ISA) 0x000001E8 (488)	Microsoft ACPI-Compliant System
	(ISA) 0x000001E9 (489)	Microsoft ACPI-Compliant System
	(ISA) 0x000001EA (490)	Microsoft ACPI-Compliant System
	(ISA) 0x000001EB (491)	Microsoft ACPI-Compliant System
	(ISA) 0x000001EC (492)	Microsoft ACPI-Compliant System
	(ISA) 0x000001ED (493)	Microsoft ACPI-Compliant System
	(ISA) 0x000001EE (494)	Microsoft ACPI-Compliant System
	(ISA) 0x000001EF (495)	Microsoft ACPI-Compliant System
	(ISA) 0x000001F0 (496)	Microsoft ACPI-Compliant System
	(ISA) 0x000001F1 (497)	Microsoft ACPI-Compliant System
	(ISA) 0x000001F2 (498)	Microsoft ACPI-Compliant System
	(ISA) 0x000001F3 (499)	Microsoft ACPI-Compliant System
	(ISA) 0x000001F4 (500)	Microsoft ACPI-Compliant System
	(ISA) 0x000001F5 (501)	Microsoft ACPI-Compliant System
	(ISA) 0x000001F6 (502)	Microsoft ACPI-Compliant System
	(ISA) 0x000001F7 (503)	Microsoft ACPI-Compliant System
	(ISA) 0x000001F8 (504)	Microsoft ACPI-Compliant System
	(ISA) 0x000001F9 (505)	Microsoft ACPI-Compliant System
	(ISA) 0x000001FA (506)	Microsoft ACPI-Compliant System
	(ISA) 0x000001FB (507)	Microsoft ACPI-Compliant System
	(ISA) 0x000001FC (508)	Microsoft ACPI-Compliant System
	(ISA) 0x000001FD (509)	Microsoft ACPI-Compliant System
	(ISA) 0x000001FE (510)	Microsoft ACPI-Compliant System
	(ISA) 0x000001FF (511)	Microsoft ACPI-Compliant System
	(PCI) 0x00000010 (16)	High Definition Audio Controller
	(PCI) 0x00000011 (17)	USB Synopsys Controller
	(PCI) 0xFFFFFEF (-17)	Intel(R) Management Engine Interface #1
	(PCI) 0xFFFFFFF5 (-11)	Intel(R) I210 Gigabit Network Connection
	(PCI) 0xFFFFFFF6 (-10)	Intel(R) I210 Gigabit Network Connection
	(PCI) 0xFFFFFFF7 (-9)	Intel(R) I210 Gigabit Network Connection
	(PCI) 0xFFFFFFF8 (-8)	Intel(R) I210 Gigabit Network Connection
	(PCI) 0xFFFFFFF9 (-7)	Intel(R) I210 Gigabit Network Connection
	(PCI) 0xFFFFFFFA (-6)	Intel(R) I210 Gigabit Network Connection
	(PCI) 0xFFFFFFF B (-5)	Intel(R) Iris(R) Xe Graphics
	(PCI) 0xFFFFFFF C (-4)	Intel(R) USB 3.10 eXtensible Host Controller - 1.20 (Microsoft)
	(PCI) 0xFFFFFFF D (-3)	Intel(R) USB 3.10 eXtensible Host Controller - 1.20 (Microsoft)
	(PCI) 0xFFFFFFF E (-2)	Standard SATA AHCI Controller

3.6 Memory Map

The memory mapping list is shown as follows:

▼	Memory
📁	[0000000000000000 - 00000000009FFFF] System board
📁	[00000000000A0000 - 0000000000BFFFF] PCI Bus
📁	[00000000000A0000 - 0000000000BFFFF] PCI Express Root Complex
📁	[00000000000C0000 - 0000000000DFFFF] System board
📁	[00000000000E0000 - 0000000000E3FFF] PCI Express Root Complex
📁	[00000000000E0000 - 0000000000FFFFFF] System board
📁	[00000000000E4000 - 0000000000E7FFF] PCI Express Root Complex
📁	[00000000000E8000 - 0000000000EBFFF] PCI Express Root Complex
📁	[00000000000EC000 - 0000000000EFFFF] PCI Express Root Complex
📁	[00000000000F0000 - 0000000000FFFFFF] PCI Express Root Complex
📁	[0000000000100000 - 00000000007FFFFFF] System board
📁	[00000000004F400000 - 00000000004F6FFFF] Intel(R) PCI Express Root Port #7 - A0BE
📁	[00000000004F400000 - 0000000000BFFFFFF] PCI Express Root Complex
📁	[00000000004F700000 - 00000000004F8FFFF] Intel(R) PCI Express Root Port #8 - A0BF
📁	[00000000004F7C000 - 00000000004F7FFFF] Intel(R) I210 Gigabit Network Connection
📁	[00000000004F800000 - 00000000004F8FFFF] Intel(R) I210 Gigabit Network Connection
📁	[00000000004F900000 - 00000000004F91FFF] Standard SATA AHCI Controller
📁	[00000000004F902000 - 00000000004F9027FF] Standard SATA AHCI Controller
📁	[00000000004F903000 - 00000000004F9030FF] Standard SATA AHCI Controller
📁	[0000000000C0000000 - 0000000000CFFFFFF] Motherboard resources
📁	[0000000000F8000000 - 0000000000FBFFFF] Microsoft Hyper-V S3 Cap
📁	[0000000000F8000000 - 0000000000FFBFFFF] PCI Bus
📁	[0000000000FD000000 - 0000000000FD68FFFF] Motherboard resources
📁	[0000000000FD690000 - 0000000000FD69FFFF] Intel(R) GPIO Controller - 34C5
📁	[0000000000FD6A0000 - 0000000000FD6AFFFF] Intel(R) GPIO Controller - 34C5
📁	[0000000000FD6B0000 - 0000000000FD6CFFFF] Motherboard resources
📁	[0000000000FD6D0000 - 0000000000FD6DFFFF] Intel(R) GPIO Controller - 34C5
📁	[0000000000FD6E0000 - 0000000000FD6EFFFF] Intel(R) GPIO Controller - 34C5
📁	[0000000000FD6F0000 - 0000000000FDFFFFFF] Motherboard resources
📁	[0000000000FE000000 - 0000000000FE01FFFF] Motherboard resources
📁	[0000000000FE010000 - 0000000000FE010FFF] Intel(R) SPI (flash) Controller - A0A4
📁	[0000000000FE04C000 - 0000000000FE04FFFF] Motherboard resources
📁	[0000000000FE050000 - 0000000000FE0AFFFF] Motherboard resources
📁	[0000000000FE0D0000 - 0000000000FE0FFFFF] Motherboard resources
📁	[0000000000FE200000 - 0000000000FE7FFFFF] Motherboard resources
📁	[0000000000FED00000 - 0000000000FED003FF] High precision event timer
📁	[0000000000FED20000 - 0000000000FED7FFFF] Motherboard resources
📁	[0000000000FED40000 - 0000000000FED44FFF] Trusted Platform Module 2.0
📁	[0000000000FED45000 - 0000000000FED8FFFF] Motherboard resources
📁	[0000000000FED90000 - 0000000000FED93FFF] Motherboard resources
📁	[0000000000FEDA0000 - 0000000000FEDA0FFF] Motherboard resources
📁	[0000000000FEDA1000 - 0000000000FEDA1FFF] Motherboard resources
📁	[0000000000FEDC0000 - 0000000000FEDC7FFF] Motherboard resources
📁	[0000000000FEE00000 - 0000000000FEEFFFFF] Motherboard resources
📁	[0000000000FF000000 - 0000000000FFFFFF] Motherboard resources
📁	[0000000000FFC00000 - 0000000000FFFFFF] System board
📁	[0000000000FE000000 - 0000000000FFFFFF] PCI Bus
📁	[0000004000000000 - 0000004000FFFFFF] Intel(R) Iris(R) Xe Graphics
📁	[0000006000000000 - 0000006000FFFFFF] Intel(R) Iris(R) Xe Graphics
📁	[0000006001300000 - 000000600130FFFF] Intel(R) USB 3.10 eXtensible Host Controller - 1.20 (Microsoft)
📁	[0000006001310000 - 000000600131FFFF] Intel(R) USB 3.10 eXtensible Host Controller - 1.20 (Microsoft)
📁	[0000006001328000 - 00000060013280FF] Intel(R) SMBus - A0A3
📁	[0000007FFCFA000 - 0000007FFCFAFFF] USB Synopsys Controller
📁	[0000007FFCFB000 - 0000007FFCFBFFF] Intel(R) Management Engine Interface #1
📁	[0000007FFCFC000 - 0000007FFCFCFFF] High Definition Audio Controller
📁	[0000007FFFD00000 - 0000007FFFDFFFFF] High Definition Audio Controller
📁	[0000007FFFE00000 - 0000007FFFEFFFFF] USB Synopsys Controller

Section 4

AMI BIOS Setup Utility

The AMI UEFI BIOS provides users with a built-in setup program to modify basic system configuration. All configured parameters are stored in a flash chip to save the setup information whenever the power is turned off. This section provides users with detailed description about how to set up basic system configuration through the AMI BIOS setup utility.

4.1 Starting

To enter the setup screens, follow the steps below:

1. Turn on the computer and press the key immediately.
2. After you press the key, the main BIOS setup menu displays. You can access the other setup screens from the main BIOS setup menu, such as the Advanced and Chipset menus.



Note

If your computer cannot boot after making and saving system changes with BIOS setup, you can restore BIOS optimal defaults by setting SW1 (see section 2.4.2).

It is strongly recommended that you should avoid changing the chipset's defaults. Both AMI and your system manufacturer have carefully set up these defaults that provide the best performance and reliability.

4.2 Navigation Keys

The BIOS setup/utility uses a key-based navigation system called hot keys. Most of the BIOS setup utility hot keys can be used at any time during the setup navigation process. These keys include <F1>, <F2>, <Enter>, <ESC>, <Arrow> keys, and so on.



Note

Some of the navigation keys differ from one screen to another.

Hot Keys	Description
→← Left/Right	The Left and Right <Arrow> keys allow you to select a setup screen.
↑↓ Up/Down	The Up and Down <Arrow> keys allow you to select a setup screen or sub-screen.
+– Plus/Minus	The Plus and Minus <Arrow> keys allow you to change the field value of a particular setup item.
Tab	The <Tab> key allows you to select setup fields.
F1	The <F1> key allows you to display the General Help screen.
F2	The <F2> key allows you to Load Previous Values.
F3	The <F3> key allows you to Load Optimized Defaults.
F4	The <F4> key allows you to save any changes you have made and exit Setup. Press the <F4> key to save your changes.
Esc	The <Esc> key allows you to discard any changes you have made and exit the Setup. Press the <Esc> key to exit the setup without saving your changes.
Enter	The <Enter> key allows you to display or change the setup option listed for a particular setup item. The <Enter> key can also allow you to display the setup sub- screens.

4.3 Main Menu

When you first enter the setup utility, you will enter the Main setup screen. You can always return to the Main setup screen by selecting the Main tab. System Time/Date can be set up as described below. The Main BIOS setup screen is shown below.

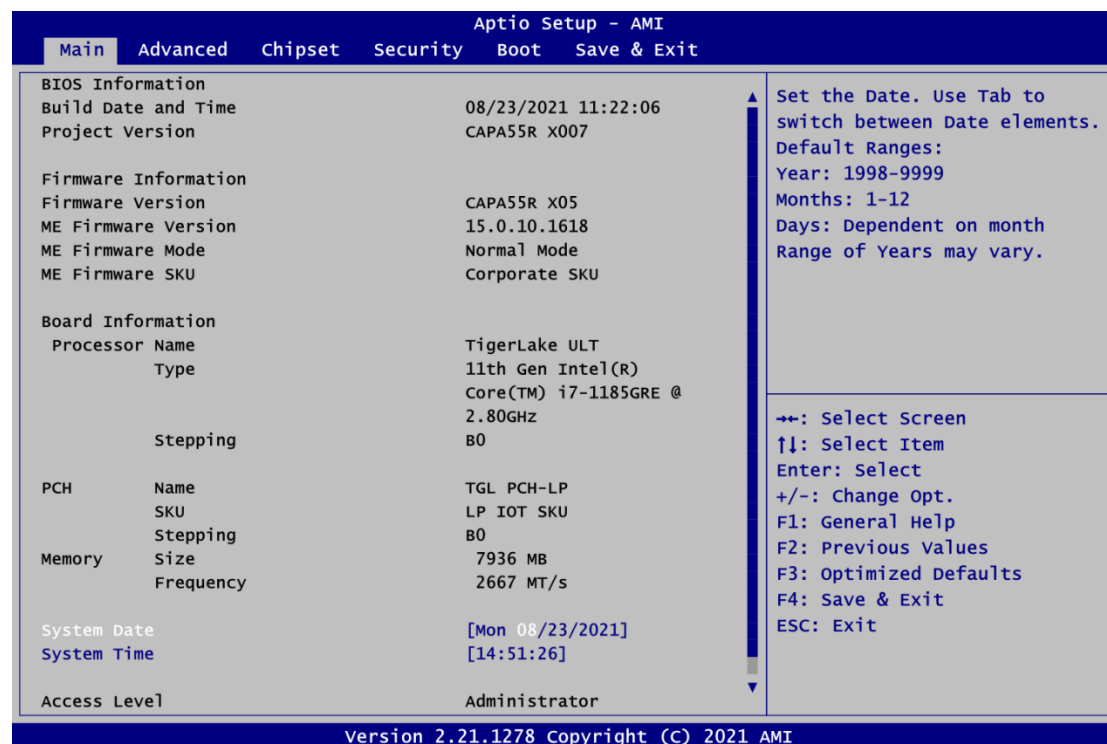

- **BIOS/Firmware/Board Information**
Display BIOS/Firmware/Board information.
- **System Date/Time**
Use this option to change the system time and date. Highlight System Time or System Date using the <Arrow> keys. Enter new values through the keyboard. Press the <Tab> key or the <Arrow> keys to move between fields. The date must be entered in MM/DD/YY format. The time is entered in HH:MM:SS format.
- **Access Level**
Display the access level of current user.

4.4 Advanced Menu

The Advanced menu also allows users to set configuration of the CPU and other system devices. You can select any of the items in the left frame of the screen to go to the sub menus:

- ▶ EC DIO Configuration
- ▶ Serial Port Configuration
- ▶ Hardware Monitor
- ▶ Trusted Computing
- ▶ CPU Configuration
- ▶ Storage Configuration
- ▶ AMT Configuration
- ▶ USB Configuration

For items marked with “▶”, please press <Enter> for more options.

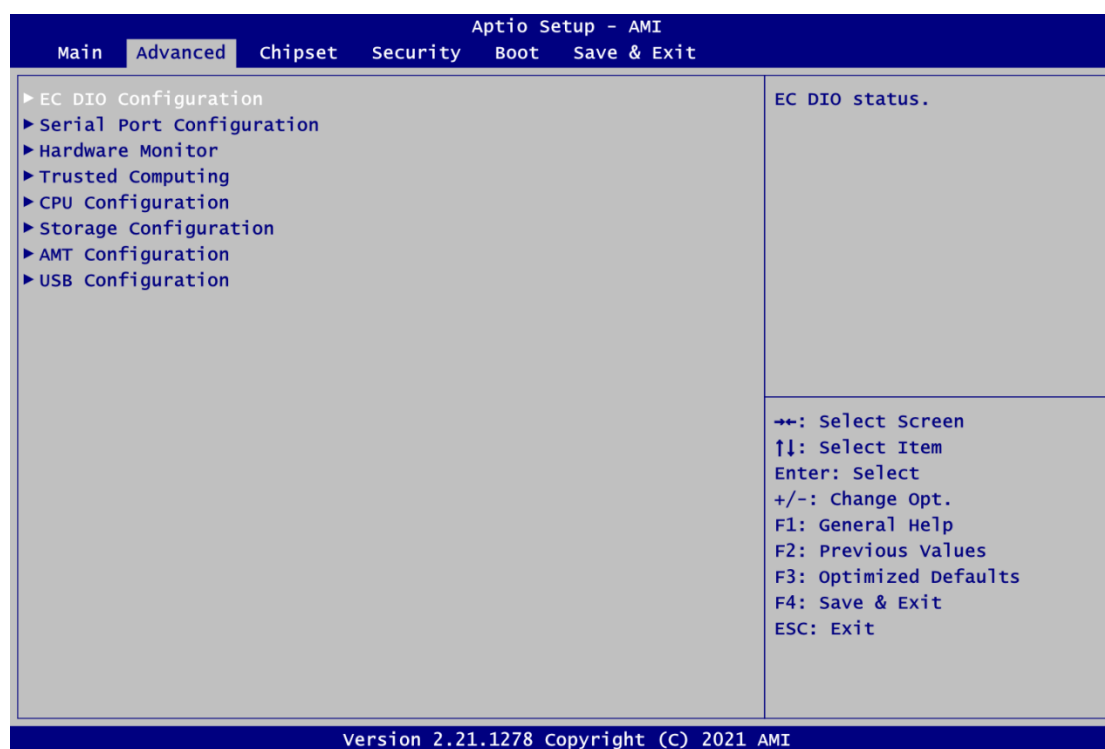

- **EC DIO Configuration**

You can use this screen to select options for the 8-bit Digital I/O Configuration. A description of the selected item appears on the right side of the screen. For items marked with "►", please press <Enter> for more options.

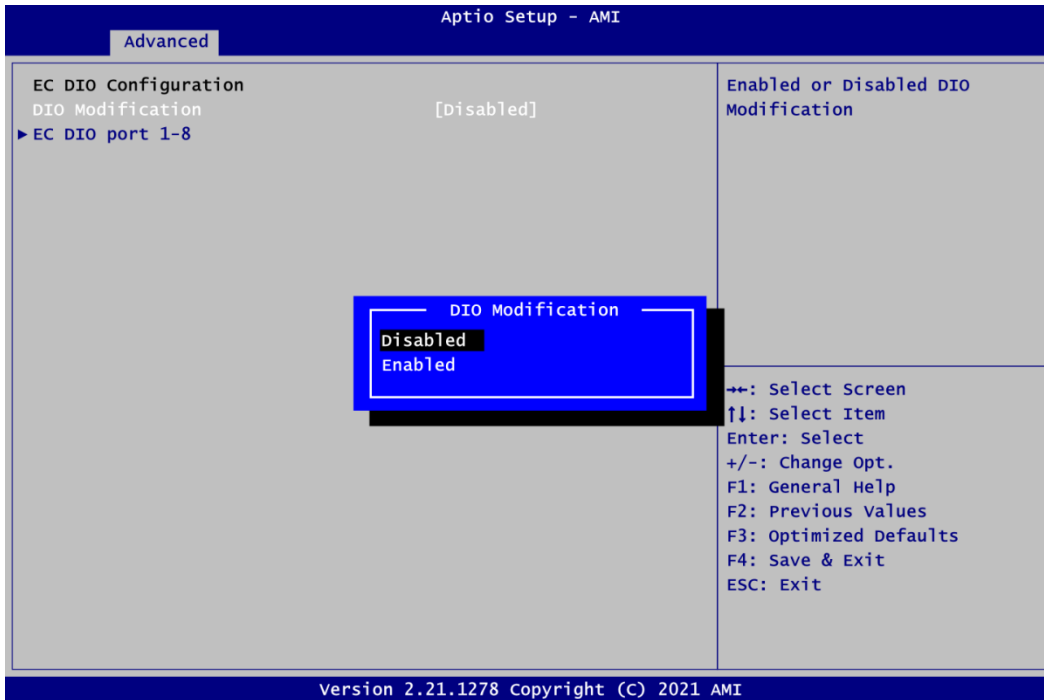
**DIO Modification**

Enable or disable digital I/O modification. The default is Disabled.

EC DIO port 1-8

Click on this option to open DIO status sub-screen.

If DIO Modification is disabled, you are not allowed to change inputs/outputs setting. If enabled, you can load manufacture default and access to the DIO status sub-screen to change input/output setting, see image below.

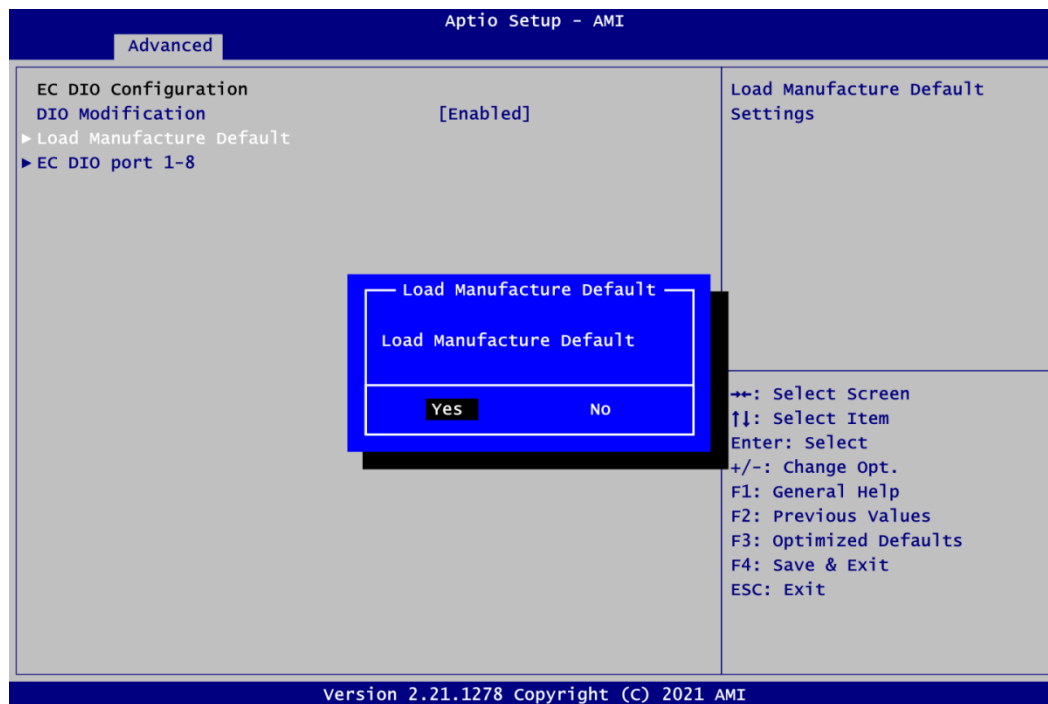

The DIO status sub-screen is as follows:

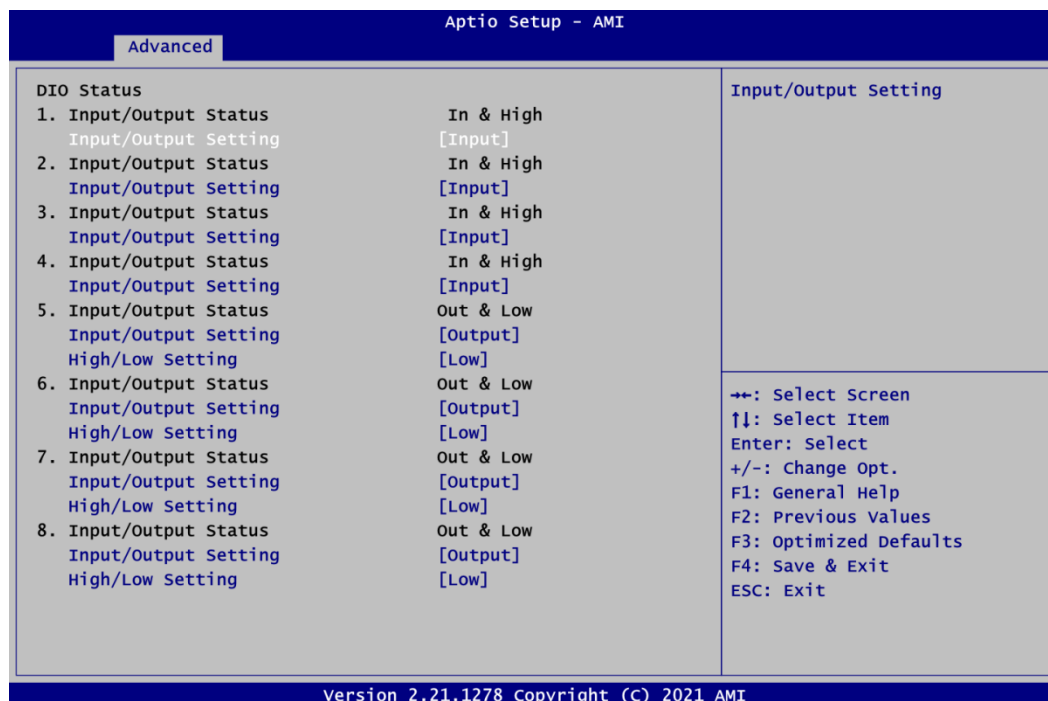

- **Serial Port Configuration**

You can use this screen to select options for serial port configuration, and change the value of the selected option. A description of the selected item appears on the right side of the screen. For items marked with “▶”, please press <Enter> for more options.



Serial Port 1~2 Configuration

Use these items to set parameters related to serial port 1~2.

- **Serial Port 1 Configuration**



Serial Port

Enable or disable serial port 1. The optimal setting for base I/O address is 248h and for interrupt request address is IRQ7.

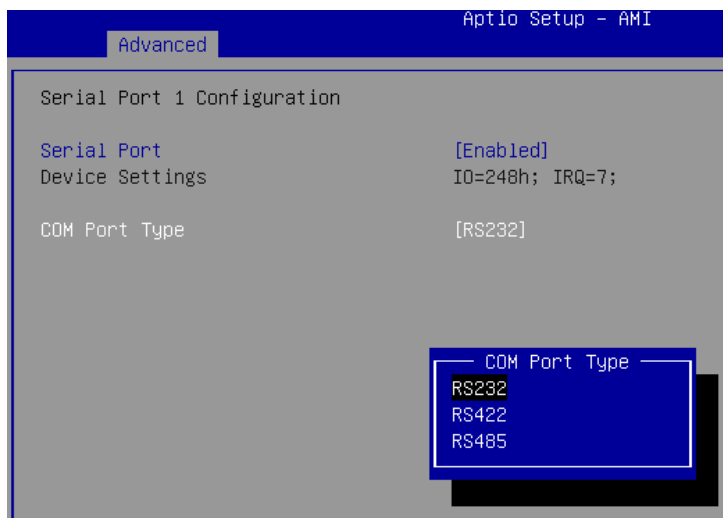

COM Port Type

Use this item to set RS-232/422/485 communication mode.

- **Serial Port 2 Configuration**

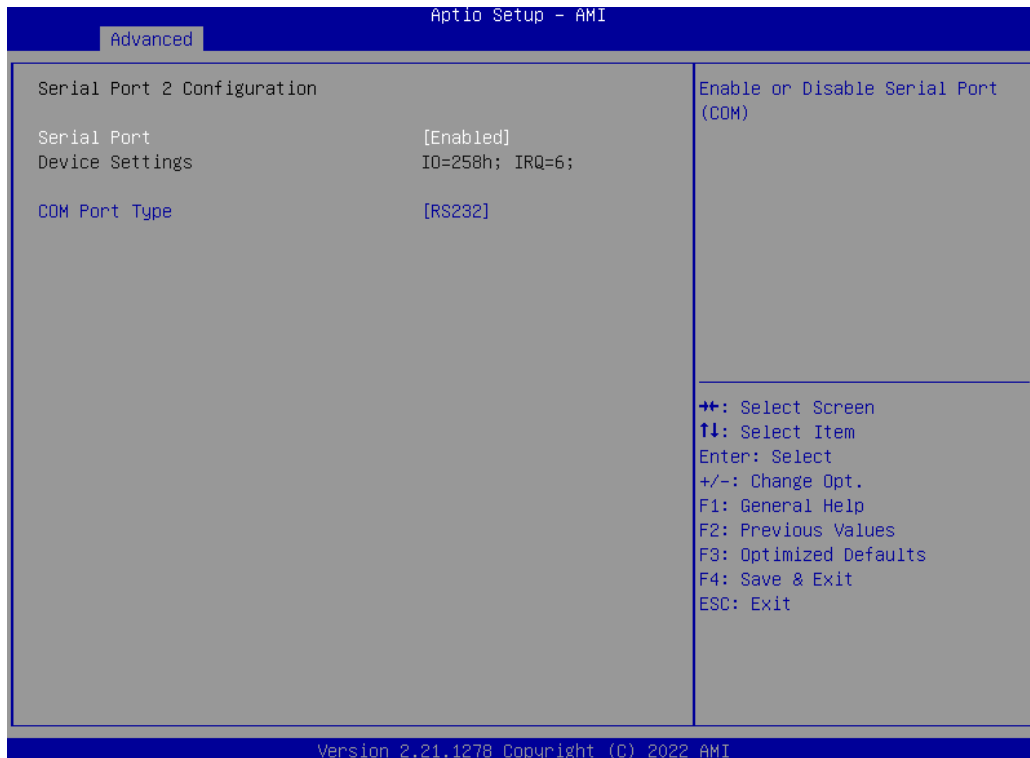
**Serial Port**

Enable or disable serial port 2. The optimal setting for base I/O address is 258h and for interrupt request address is IRQ6.

COM Port Type

Use this item to set RS-232/422/485 communication mode.

- **Hardware Monitor**

This screen shows hardware health status.

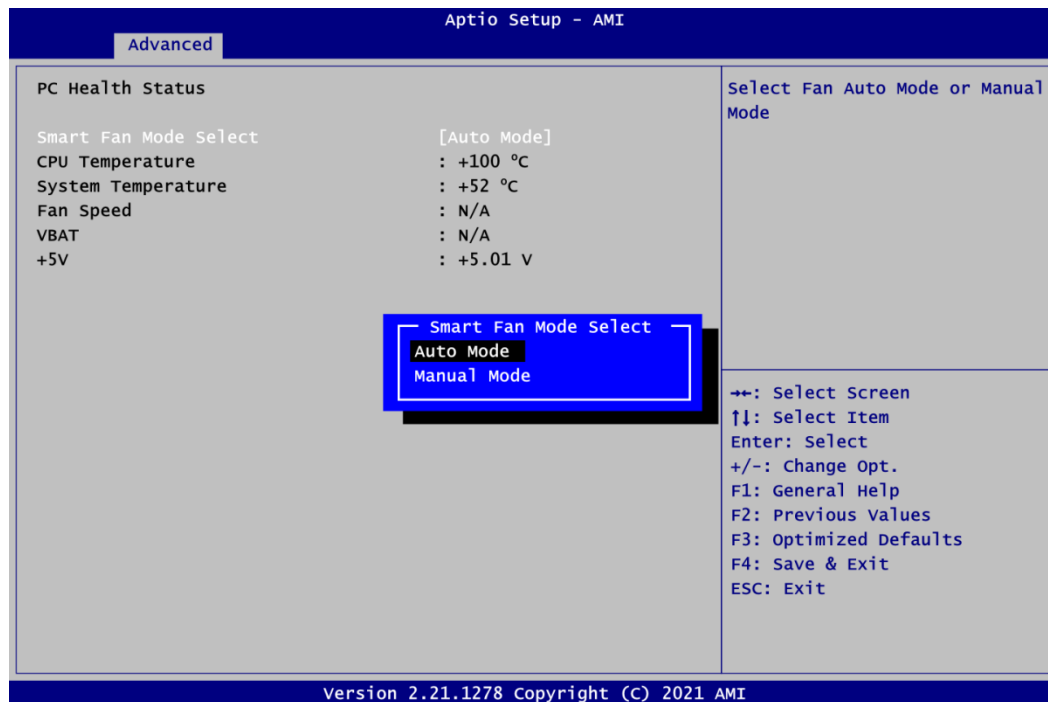

This screen displays the temperature of system and CPU, fan speed in RPM and system voltages (VBAT and +5V).

Smart Fan Mode Select

Set Smart Fan mode. The default is Auto Mode. In Auto Mode, the fan spins at different speed depending on system temperature; the higher the temperature, the faster the system fan spins. In Manual Mode; select fan speed control item, then user can manually change system fan speed to 100%, 75%, 50% or 0% (see image below).

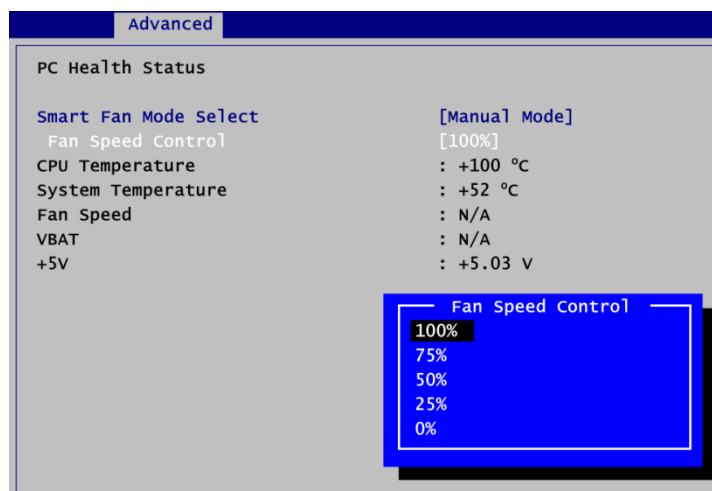

- **Trusted Computing**

You can use this screen for TPM (Trusted Platform Module) configuration. It also shows current TPM status information.

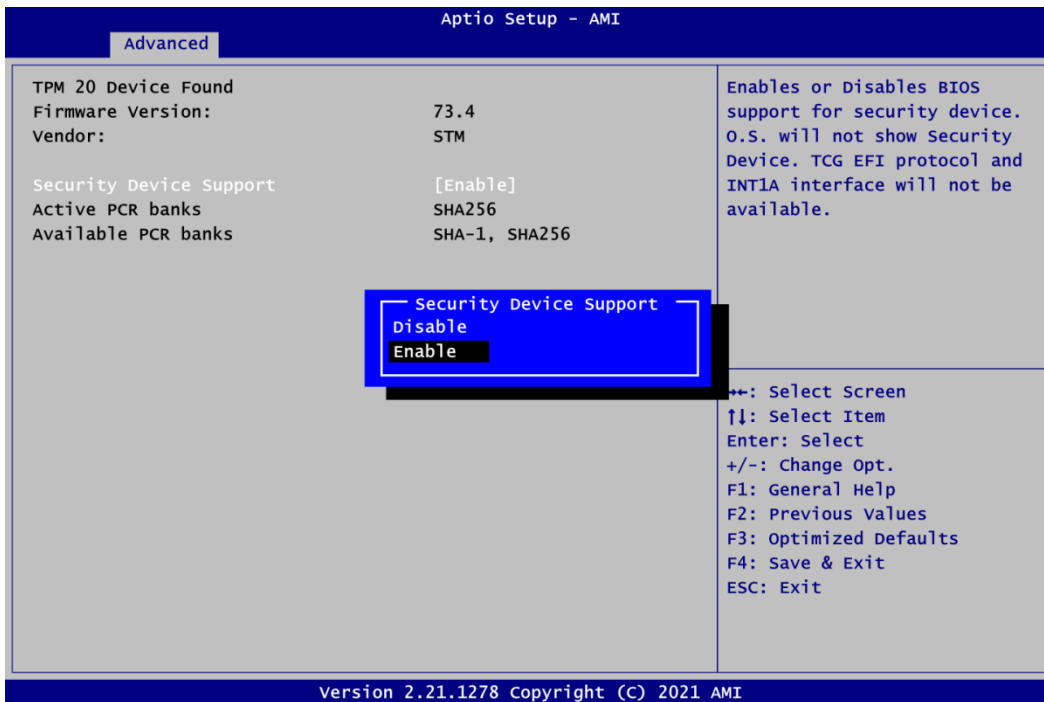

Security Device Support

Enable or disable BIOS support for security device.

- **CPU Configuration**

This screen shows the CPU Configuration.

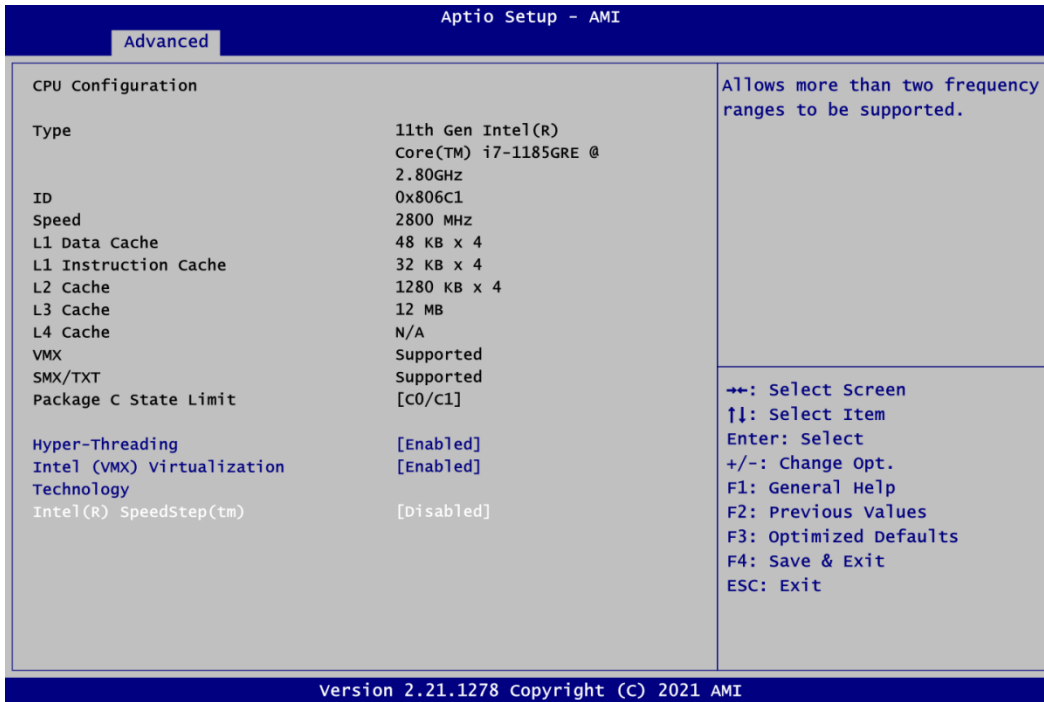

Hyper-Threading

Enable or disable Hyper-Threading Technology. When enabled, it allows a single physical processor to multitask as multiple logical processors. When disabled, only one thread per enabled core is enabled.

Intel (VMX) Virtualization Technology

Enable or disable Intel® Virtualization Technology. When enabled, a VMM (Virtual Machine Mode) can utilize the additional hardware capabilities. It allows a platform to run multiple operating systems and applications independently, hence enabling a computer system to work as several virtual systems.

Intel(R) SpeedStep(tm)

Enable or disable Intel® SpeedStep. It allows more than two frequency ranges to be supported.

Advanced	
CPU Configuration	
Type	11th Gen Intel(R) Core(TM) i7-1185GRE @ 2.80GHz
ID	0x806C1
Speed	2800 MHz
L1 Data Cache	48 KB x 4
L1 Instruction Cache	32 KB x 4
L2 Cache	1280 KB x 4
L3 Cache	12 MB
L4 Cache	N/A
VMX	Supported
SMX/TXT	Supported
Package C State Limit	[C0/C1]
Hyper-Threading	[Enabled]
Intel (VMX) Virtualization Technology	[Enabled]
Intel(R) SpeedStep(tm) Turbo Mode	[Enabled] [Disabled]

Turbo Mode

Enable or disable Intel® turbo boost mode allowing processor cores to run faster but not exceed CPU defined frequency limits.

- **Storage Configuration**

You can use this screen to select options for storage configuration, and change the value of the selected option. A description of the selected item appears on the right side of the screen. For items marked with “▶”, please press <Enter> for more options.

Aptio Setup - AMI	
Advanced	
Storage Configuration	SATA Device Options Settings
▶ SATA And RST Configuration	
▶ NVMe Configuration	
	++: Select Screen ↑↓: Select Item Enter: Select +/-: Change Opt. F1: General Help F2: Previous Values F3: Optimized Defaults F4: Save & Exit ESC: Exit
Version 2.21.1278 Copyright (C) 2021 AMI	

- **SATA and RST Configuration**

During system boot up, BIOS automatically detects the presence of SATA devices. In the SATA and RST configuration menu, you can see hardware currently installed in the SATA port.

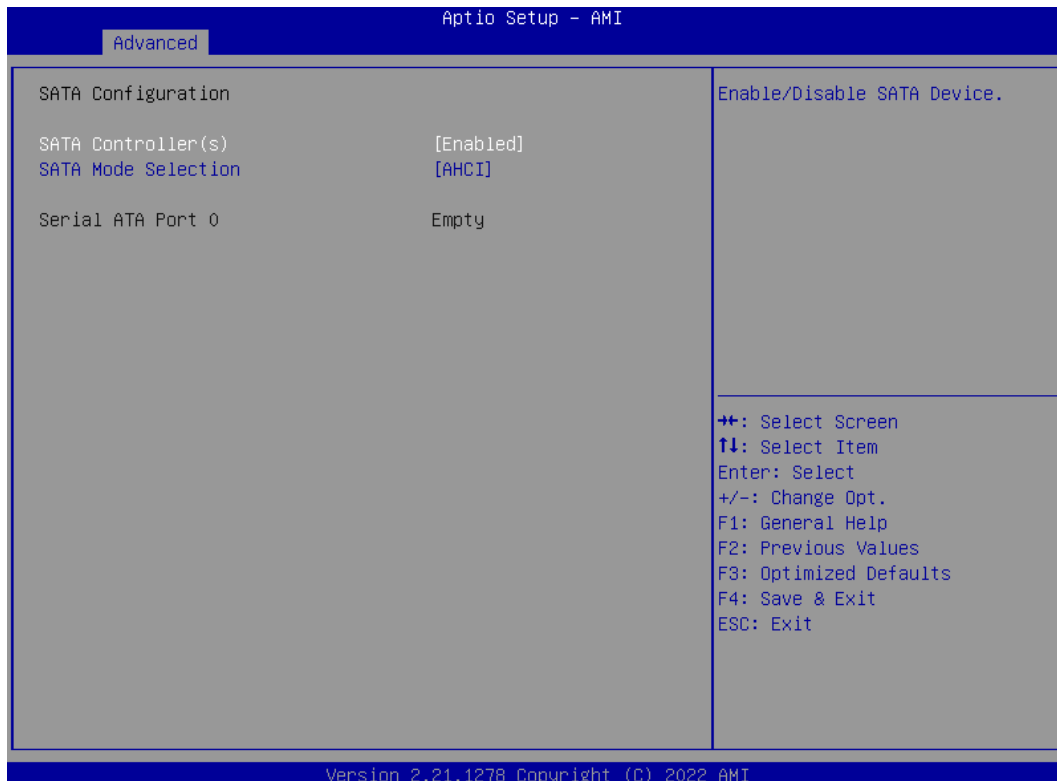

SATA Controller(s)

Enable or disable the SATA Controller feature.

SATA Mode Selection

Determine how SATA controller(s) operate.

- **NVMe Configuration**

If M.2 NVMe card is installed in M.2 Key M Connector (CN6) (see section 2.6.5), you will see related information and images given below.



- **AMT Configuration**

Use this screen to configure AMT parameters.

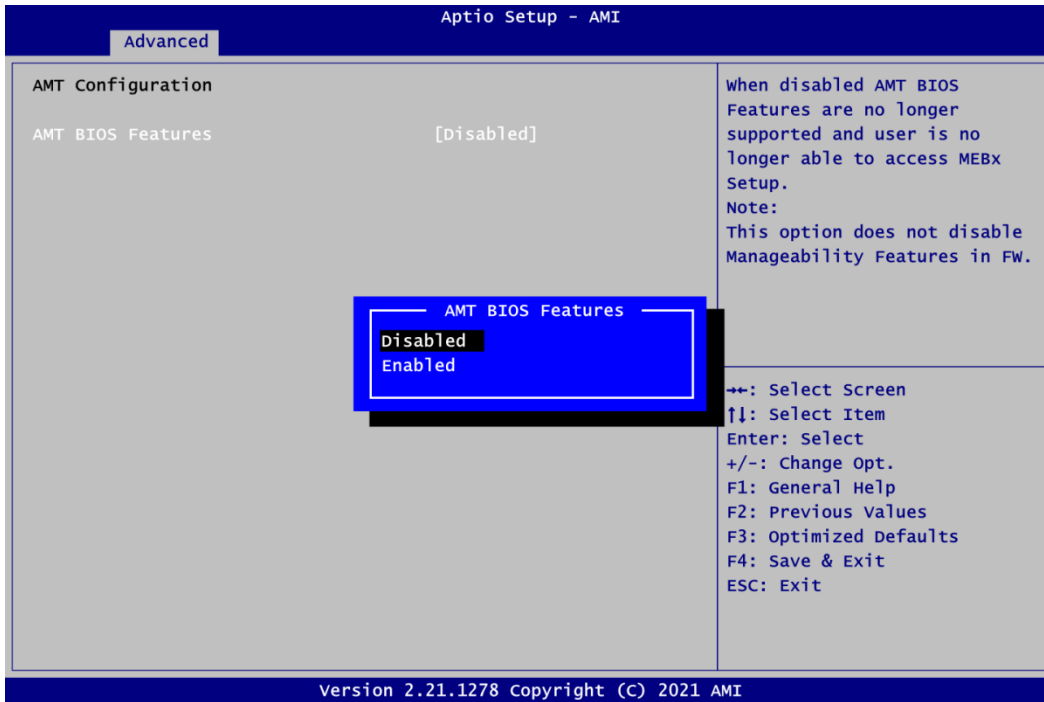

AMT BIOS Features

Enable or disable Active Management Technology BIOS features.

- **USB Configuration**

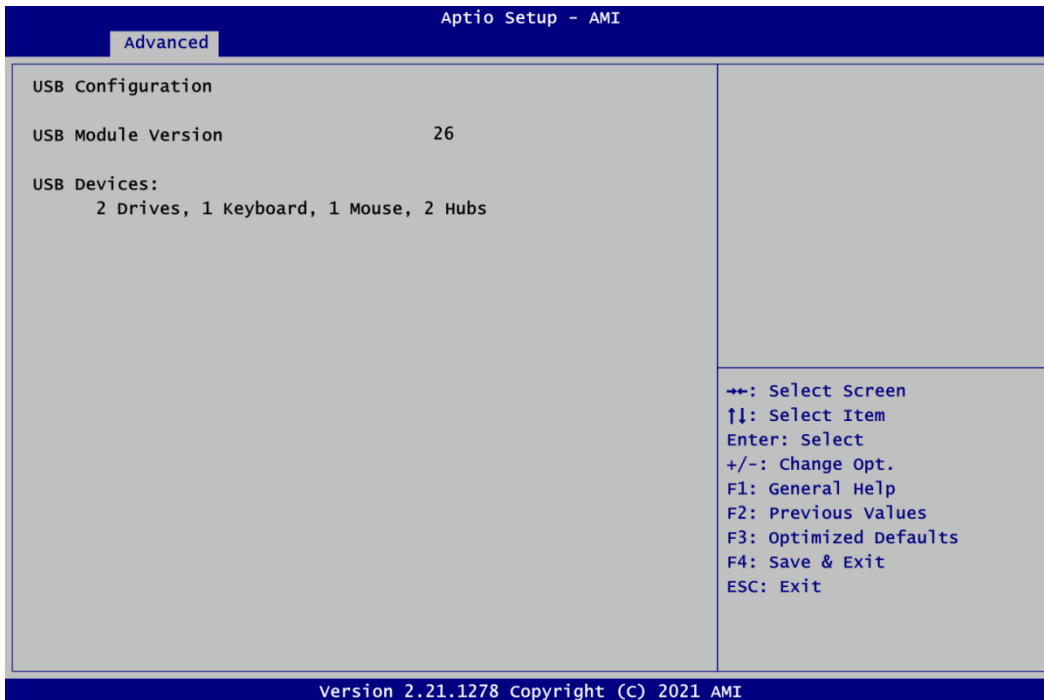

USB Devices

Display all detected USB devices.

4.5 Chipset Menu

The Chipset menu allows users to change the advanced chipset settings.

- **System Agent (SA) Configuration**

This screen allows users to configure System Agent (SA) parameters.



LVDS Panel Device

Enable or disable LVDS panel device.

LVDS Panel Type

Select the appropriate LVDS panel resolution, see image below.

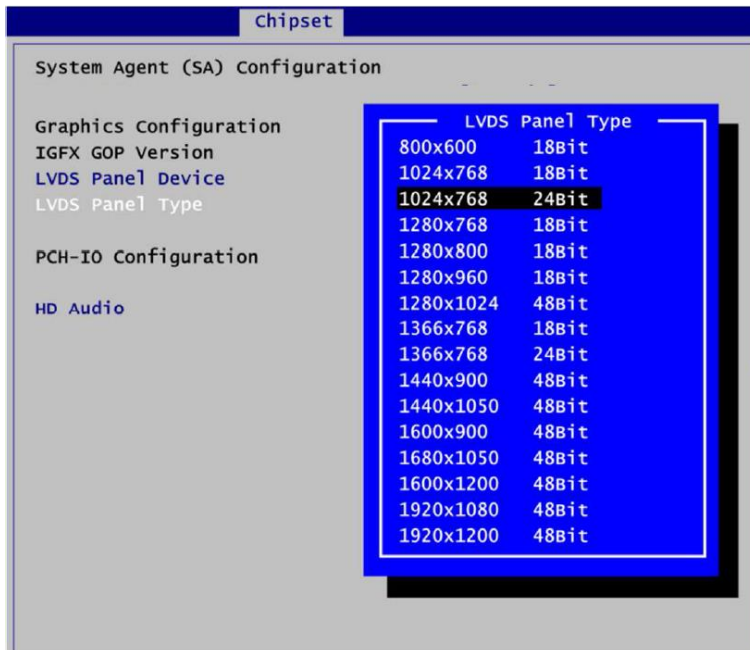

HD Audio

Control detection of the HD Audio device.

- Disabled: HDA will be unconditionally disabled.
- Enabled: HDA will be unconditionally enabled.

4.6 Security Menu

The Security menu allows users to change the security settings for the system.



- **Administrator Password.**
Set administrator password.
- **User Password**
Set user password.

4.7 Boot Menu

The Boot menu allows users to change boot options of the system.

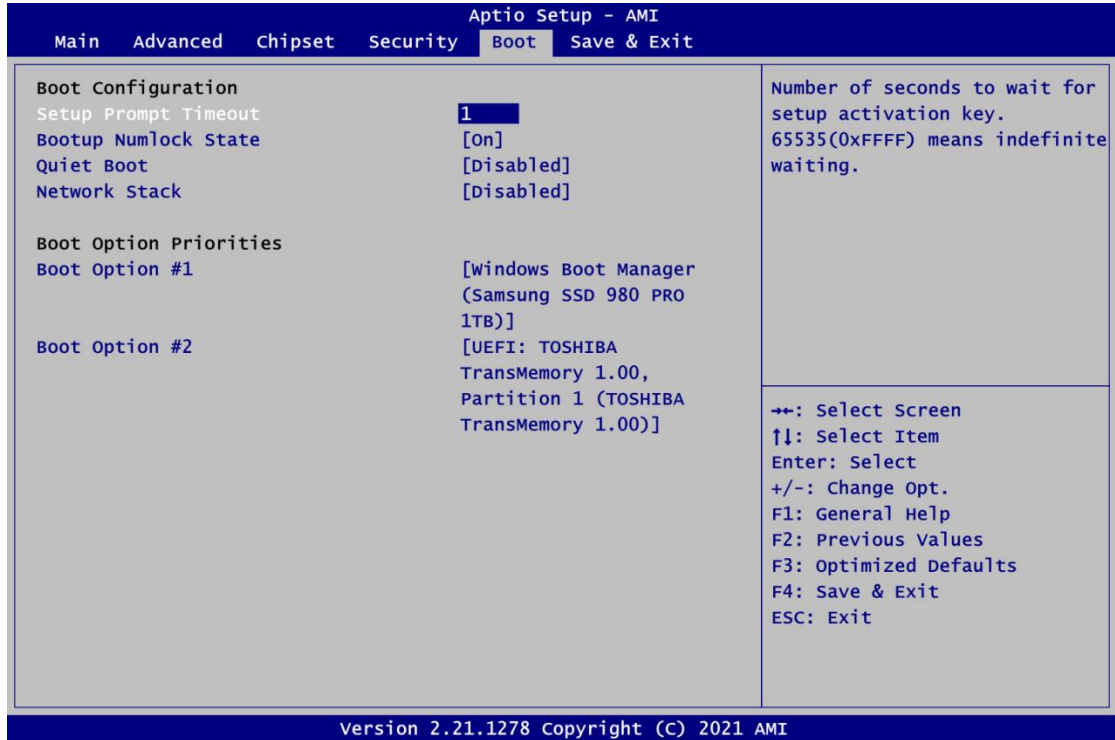

- Setup Prompt Timeout**
 Number of seconds to wait for setup activation key. 65535(0xFFFF) means indefinite waiting.
- Bootup NumLock State**
 Use this item to select the power-on state for the keyboard NumLock.
- Quiet Boot**
 Select to display either POST output messages or a splash screen during boot-up.
- Network Stack**
 Enable or disable UEFI Network stack.
- Boot Option Priorities [Boot Option #1, ...]**
 These are settings for boot priority. Specify the boot device priority sequence from the available devices.

4.8 Save & Exit Menu

The Save & Exit menu allows users to load your system configuration with optimal or fail-safe default values.

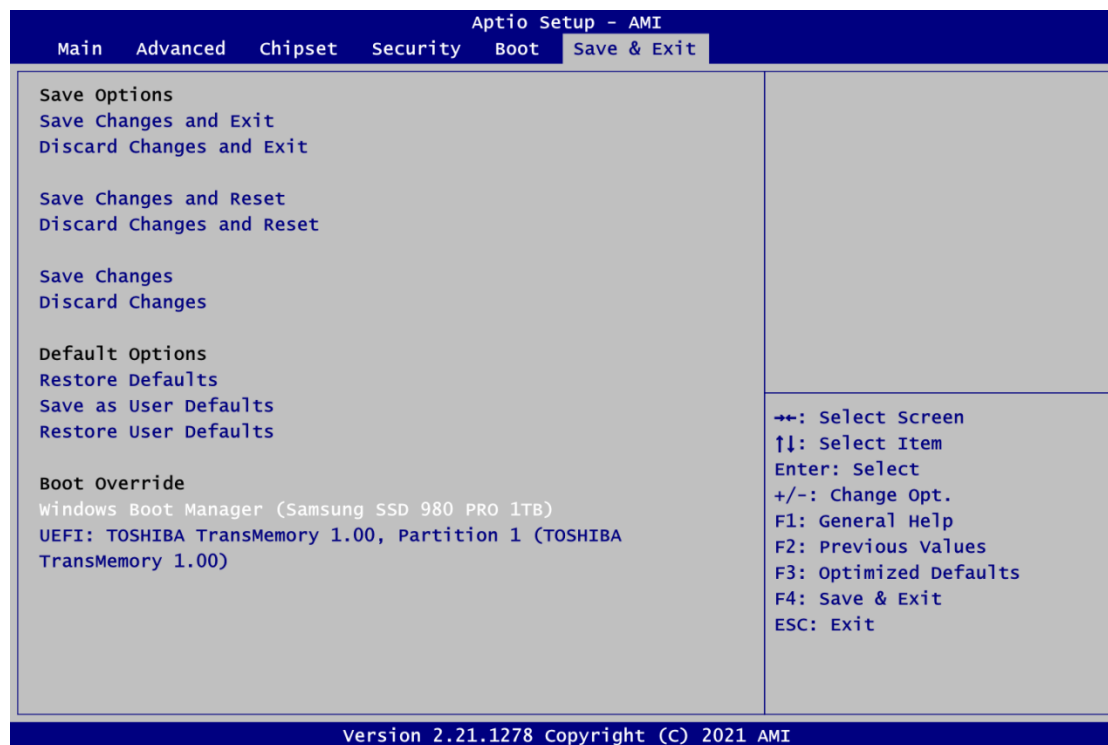

- Save Changes and Exit**
 When you have completed the system configuration changes, select this option to leave Setup and return to Main Menu. Select Save Changes and Exit from the Save & Exit menu and press <Enter>. Select Yes to save changes and exit.
- Discard Changes and Exit**
 Select this option to quit Setup without making any permanent changes to the system configuration and return to Main Menu. Select Discard Changes and Exit from the Save & Exit menu and press <Enter>. Select Yes to discard changes and exit.
- Save Changes and Reset**
 When you have completed the system configuration changes, select this option to leave Setup and reboot the computer so the new system configuration parameters can take effect. Select Save Changes and Reset from the Save & Exit menu and press <Enter>. Select Yes to save changes and reset.
- Discard Changes and Reset**
 Select this option to quit Setup without making any permanent changes to the system configuration and reboot the computer. Select Discard Changes and Reset from the Save & Exit menu and press <Enter>. Select Yes to discard changes and reset.
- Save Changes**
 When you have completed the system configuration changes, select this option to save changes. Select Save Changes from the Save & Exit menu and press <Enter>. Select Yes to save changes.

- **Discard Changes**
Select this option to quit Setup without making any permanent changes to the system configuration. Select Discard Changes from the Save & Exit menu and press <Enter>. Select Yes to discard changes.
- **Restore Defaults**
It automatically sets all Setup options to a complete set of default settings when you select this option. Select Restore Defaults from the Save & Exit menu and press <Enter>.
- **Save as User Defaults**
Select this option to save system configuration changes done so far as User Defaults. Select Save as User Defaults from the Save & Exit menu and press <Enter>.
- **Restore User Defaults**
It automatically sets all Setup options to a complete set of User Defaults when you select this option. Select Restore User Defaults from the Save & Exit menu and press <Enter>.
- **Boot Override**
Select a drive to immediately boot that device regardless of the current boot order.

Appendix A

Watchdog Timer

A.1 About Watchdog Timer

After the system stops working for a while, it can be auto-reset by the watchdog timer. The integrated watchdog timer can be set up in the system reset mode by program.

A.2 Watchdog Timer Programming

```

////////////////////////////////////
#include <stdio.h>
#include <conio.h>
#include <stdlib.h>
#include <dos.h>

#define AXIOM_WDT_TIMER          0xFA10
#define AXIOM_WDT_TRIGGER       0xFA12

void main()
{
    unsigned long int DefaultTimer = 0xFFFF; // 65535 Seconds
    unsigned long int CurrentWdtTimer = 0;

    clrscr();

    // Set WDT Timer, maximum is 65535 seconds
    outportw(AXIOM_WDT_TIMER, DefaultTimer);
    printf("Set WDT Timer to: %ld Seconds\n", DefaultTimer);

    // 0x01: Enabled WDT, 0x00: Disabled WDT
    outportb(AXIOM_WDT_TRIGGER, 0x01);
    printf("Enabled WDT Timer\n");

    while(1)
    {
        clrscr();
        // Get current WDT Timer
        CurrentWdtTimer = inportw(AXIOM_WDT_TIMER);
        printf("Set WDT Timer to: %ld Seconds\n", DefaultTimer);
        printf("Current WDT Timer: %ld Seconds\n", CurrentWdtTimer);
        delay(1000);
    }
}
////////////////////////////////////

```

This page is intentionally left blank.

Appendix B

Digital I/O

B.1 About Digital I/O

The onboard GPIO or digital I/O has 8 bits (DIO0~7). Each bit can be set to function as input or output by software programming. In default, all pins are pulled high with +5V level (according to main power). The BIOS default settings are 4 inputs and 4 outputs.

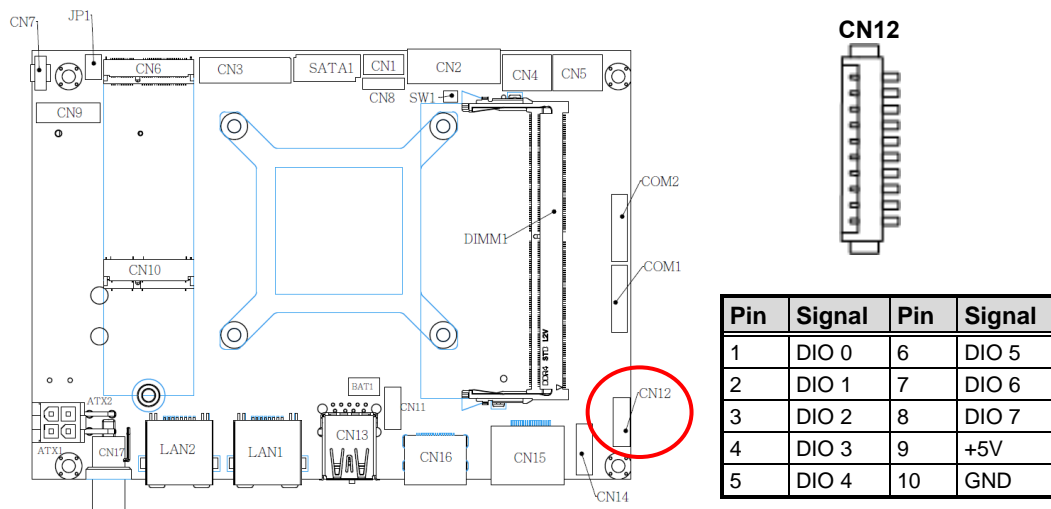

B.2 Digital I/O Programming

```
////////////////////////////////////////////////////////////////////////////////////////////////////////////////////////////////
```

```
#include <stdio.h>
#include <conio.h>
#include <stdlib.h>
#include <dos.h>
```

```
#define AXIOM_DIO_IN_OUT_ADDR0xFA31
#define AXIOM_DIO_HIGH_LOW_ADDR0xFA32
```

```
#define DIO_PIN1 BIT0 //correspondence to HW pin is GPIO
#define DIO_PIN2 BIT1 //correspondence to HW pin is GPI1
#define DIO_PIN3 BIT2 //correspondence to HW pin is GPI2
#define DIO_PIN4 BIT3 //correspondence to HW pin is GPI3
#define DIO_PIN5 BIT4 //correspondence to HW pin is GPO0
#define DIO_PIN6 BIT5 //correspondence to HW pin is GPO1
#define DIO_PIN7 BIT6 //correspondence to HW pin is GPO2
```

```
#define DIO_PIN8 BIT7           //correspondence to HW pin is GPO3
void main()
{
    // BIT0-BIT3 is input, BIT4-BIT7 is output
    unsigned char DIO_DefaultInOutSetting = 0x0F;
    // BIT0-BIT3 is input so do not care, BIT4-BIT7 is High
    unsigned char DIO_DefaultHighLowSetting = 0xF0;

    clrscr();

    // Set DIO input/output, 1: input, 0: output
    // BIT0-BIT3 is input, BIT4-BIT7 is output
    outportb(AXIOM_DIO_IN_OUT_ADDR, DIO_DefaultInOutSetting);
    printf("DIO input/output set to 0x%X \n", DIO_DefaultInOutSetting);
    printf("BIT0-BIT3 is setting to input,BIT4-BIT7 is setting to output\n");

    // Set DIO High/Low, 1: High, 0: Low
    // Now is set to BIT0-BIT3 is Low, BIT4-BIT7 is High
    outportb(AXIOM_DIO_HIGH_LOW_ADDR, DIO_DefaultHighLowSetting);
    printf("DIO High/Low set to 0x%X \n", DIO_DefaultHighLowSetting);
    printf("BIT0-BIT3 is set to input so do not care, BIT4-BIT7 is setting to High");

    while(1);
}
////////////////////////////////////
```

Appendix C

iAMT Settings

The Intel® Active Management Technology (Intel® iAMT) has decreased a major barrier to IT efficiency that uses built-in platform capabilities and popular third-party management and security applications to allow IT a better discovering, healing, and protection their networked computing assets.

In order to utilize Intel® iAMT you must enter the ME BIOS (<Ctrl + P> during system startup), change the ME BIOS password, and then select “Intel® iAMT” as the manageability feature.

C.1 Entering MEBx

1. Go to BIOS to enable iAMT function (see section 4.4).
2. Exit from BIOS after starting iAMT, and press <Ctrl + P> to enter MEBx Setting.



Note

It is better to press <Ctrl + P> before the screen popping out.

C.2 Set and Change Password

1. You will be asked to set a password when first log in. The default password is “admin”.

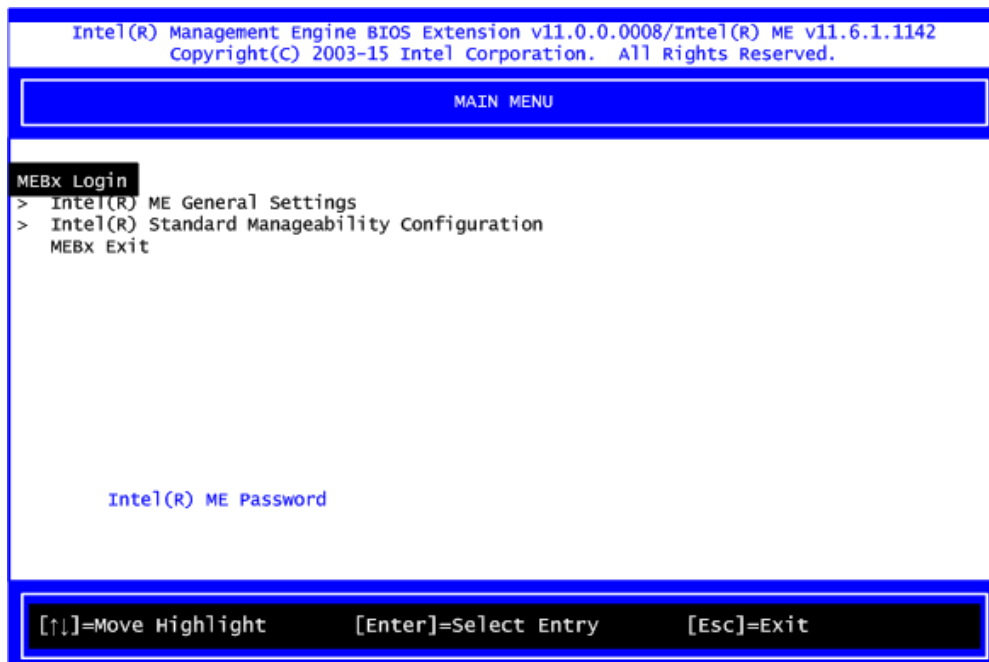

2. You will be asked to change the password before setting ME.
3. You must confirm your new password while revising. The new password must contain: (example: **!!11qqQQ**) (default value).
 - Eight characters
 - One upper case
 - One lower case
 - One number
 - One special symbol, such as ! ` \$ or ; ` (` " , excepted)

Underline (_) and space are valid characters for password, but they won't make higher complexity.

4. From Main Menu, select ME General Settings to get into ME Platform Configuration screen. In this screen you can modify Local FW Update setting.

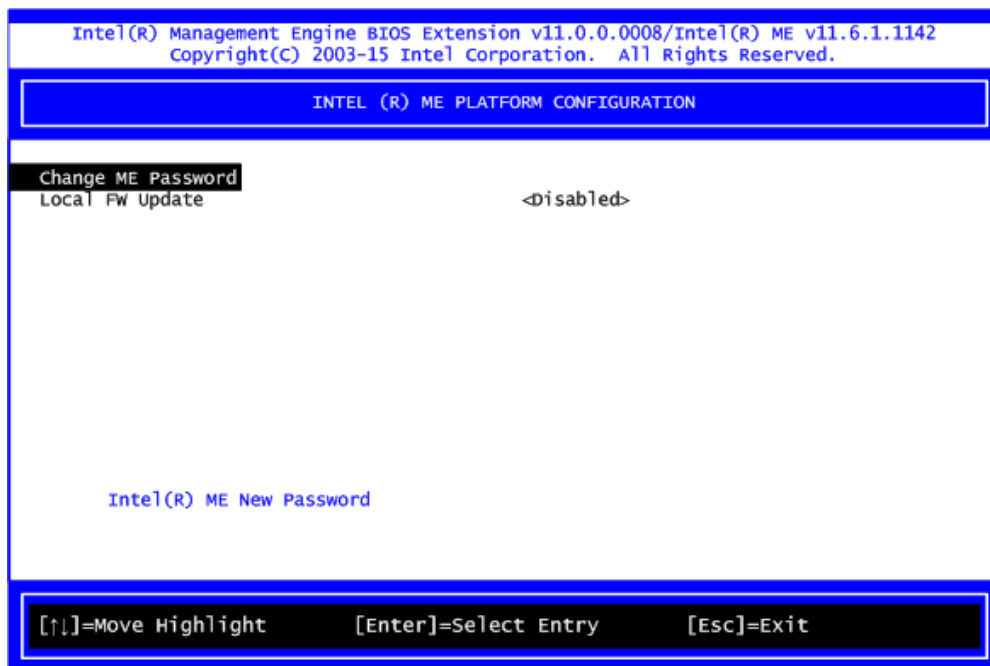

5. Return to Main Menu.

C.3 iAMT Configuration

1. From Main Menu, select Intel® Standard Manageability Configuration and press <Enter>.
2. Set Manageability Feature Selection to Enabled.

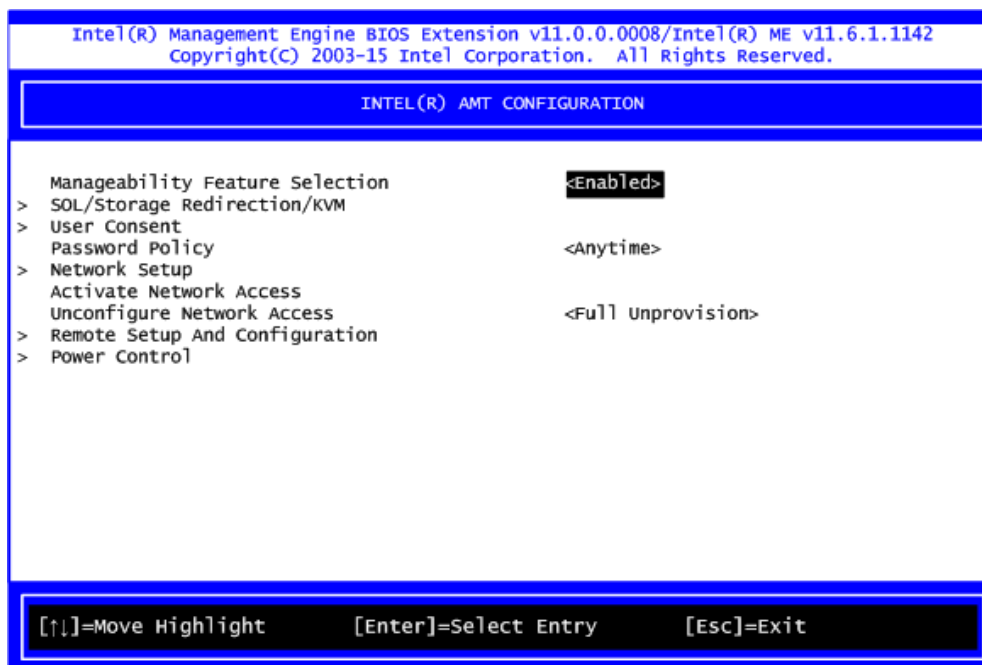

- **SOL/Storage Redirection/KVM**

This screen is for enabling or disabling Serial-over-LAN (SOL)/Storage Redirection/Keyboard Video Mouse (KVM) functionality.

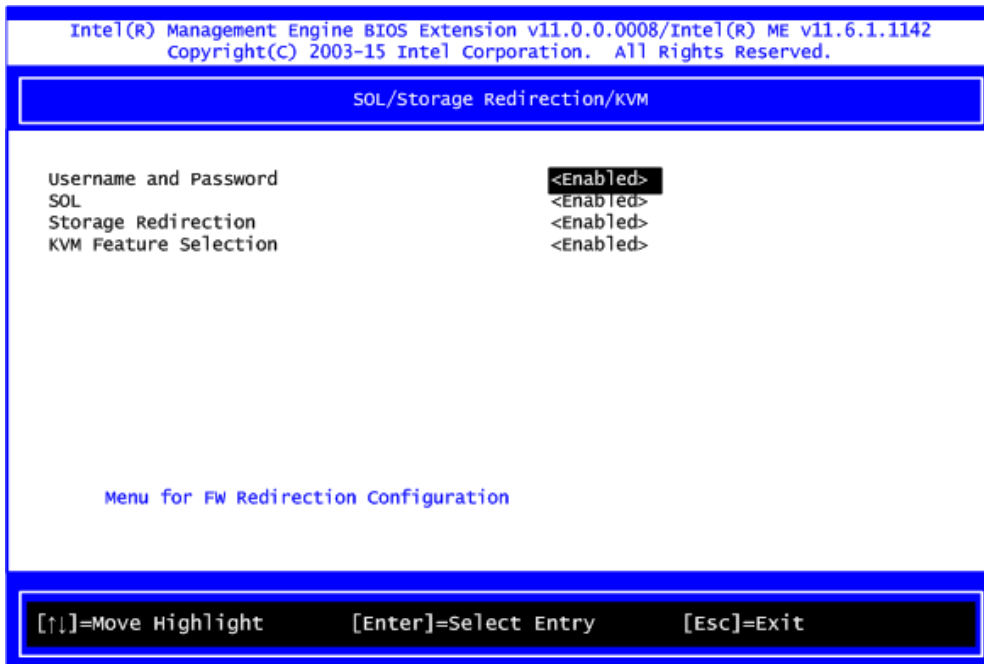

- **User Consent**

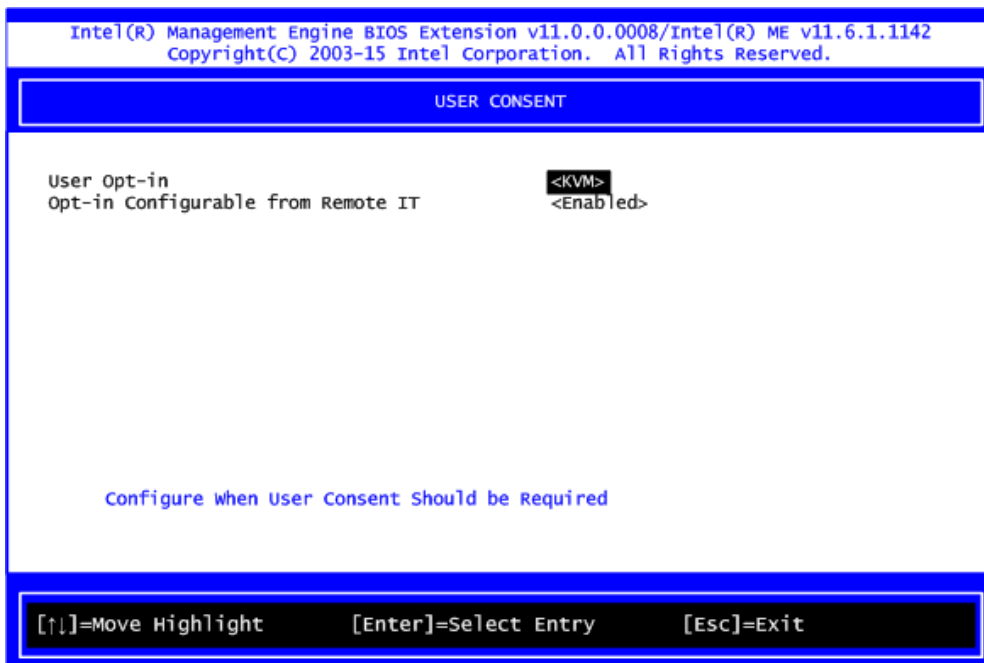

User Opt-in

Configure this item when user consent should be required.

Opt-in Configurable from Remote IT

Enable or disable remote change capability of user consent feature.

- **Network Setup**

1. From Intel® AMT Configuration Menu, select Network Setup.
2. Select ME Network Name Settings to set computer host and domain name.

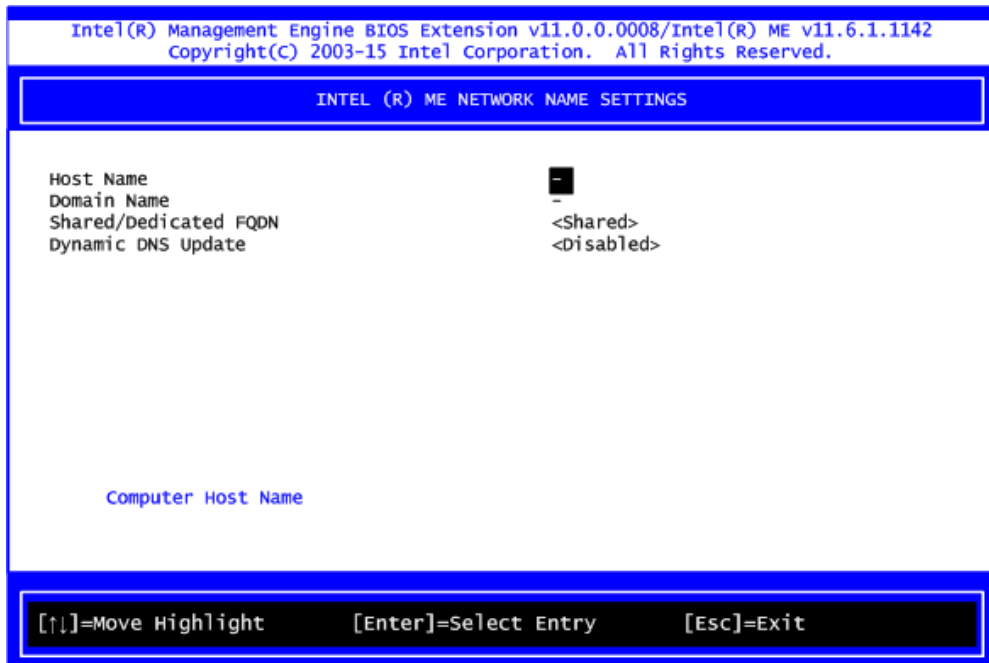
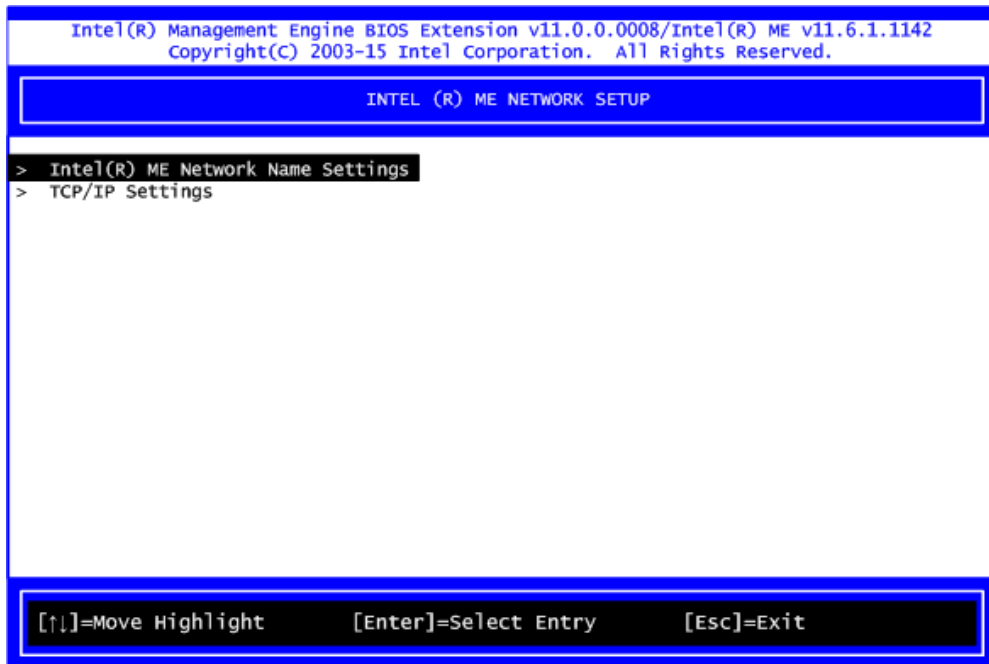

3. Select TCP/IP to get into Network interface. Get into DHCP Mode and set it to Disabled.

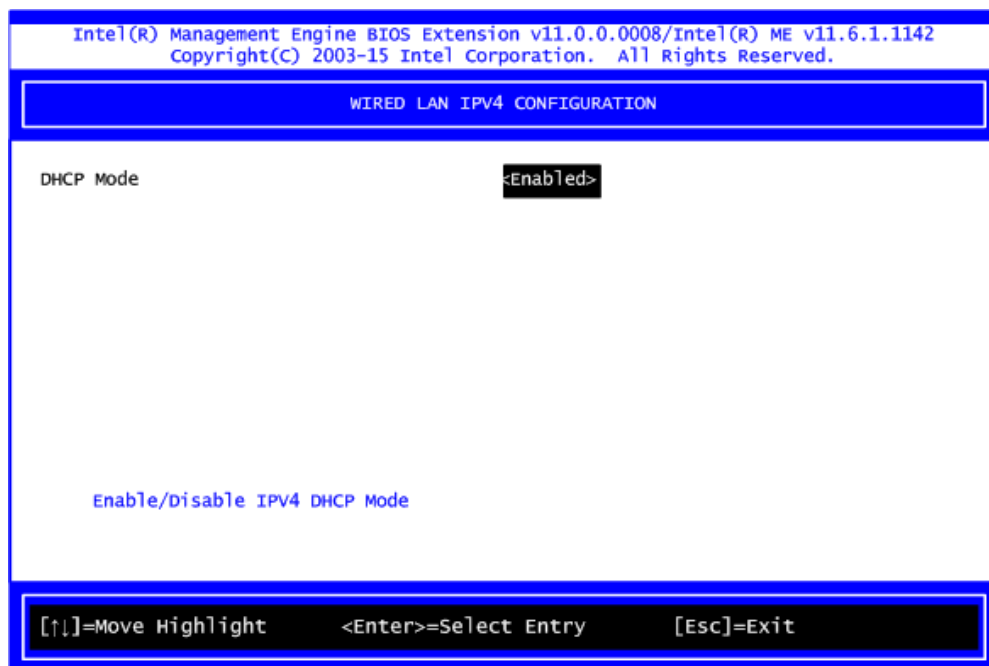
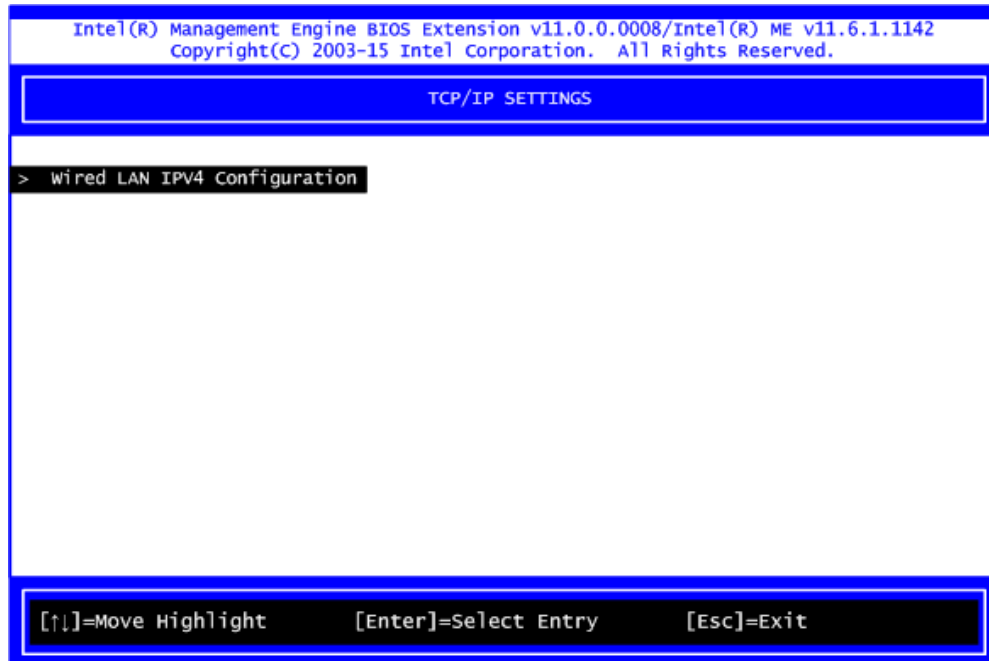

4. If DHCP Mode is disabled, set the following settings:
 - IP address
 - Subnet mask

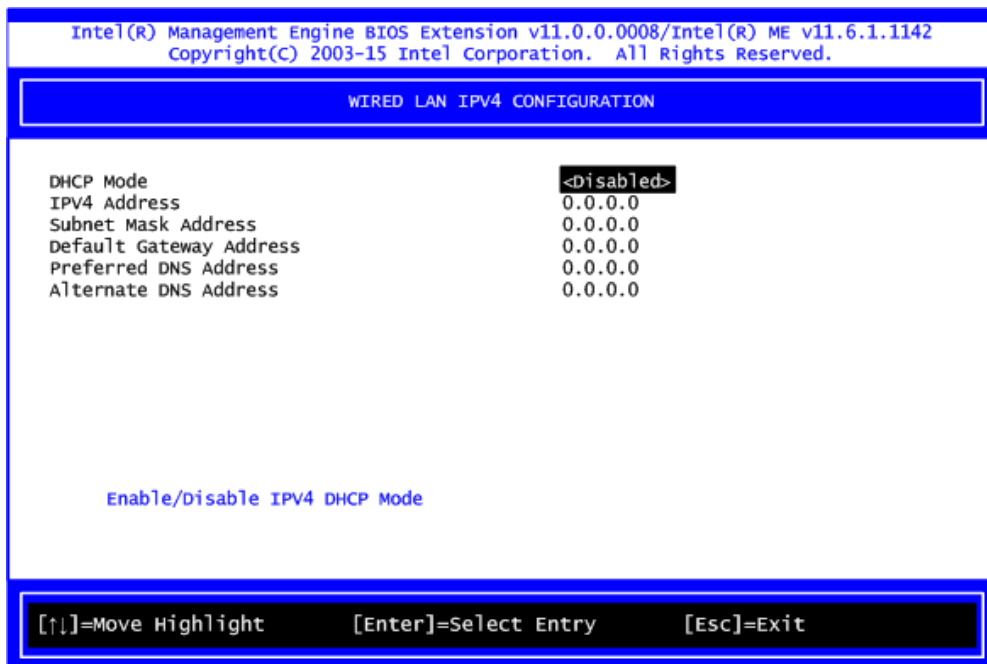

5. Go back to Intel® iAMT Configuration, then select Activate Network Access and press <Enter>.

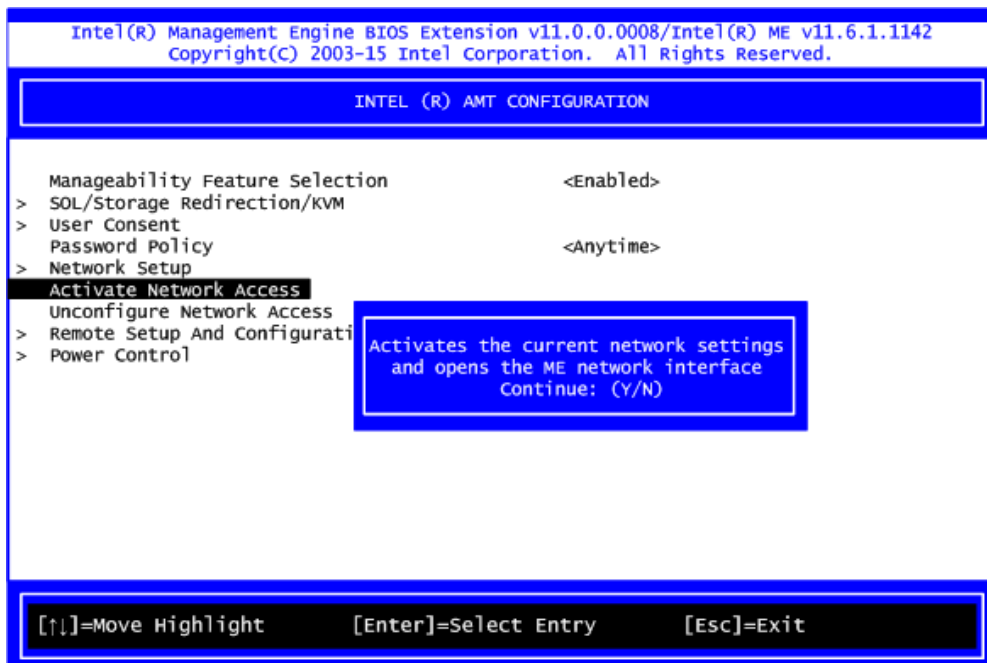

6. Exit from MEBx after completing the iAMT settings.

- Remote Setup and Configuration

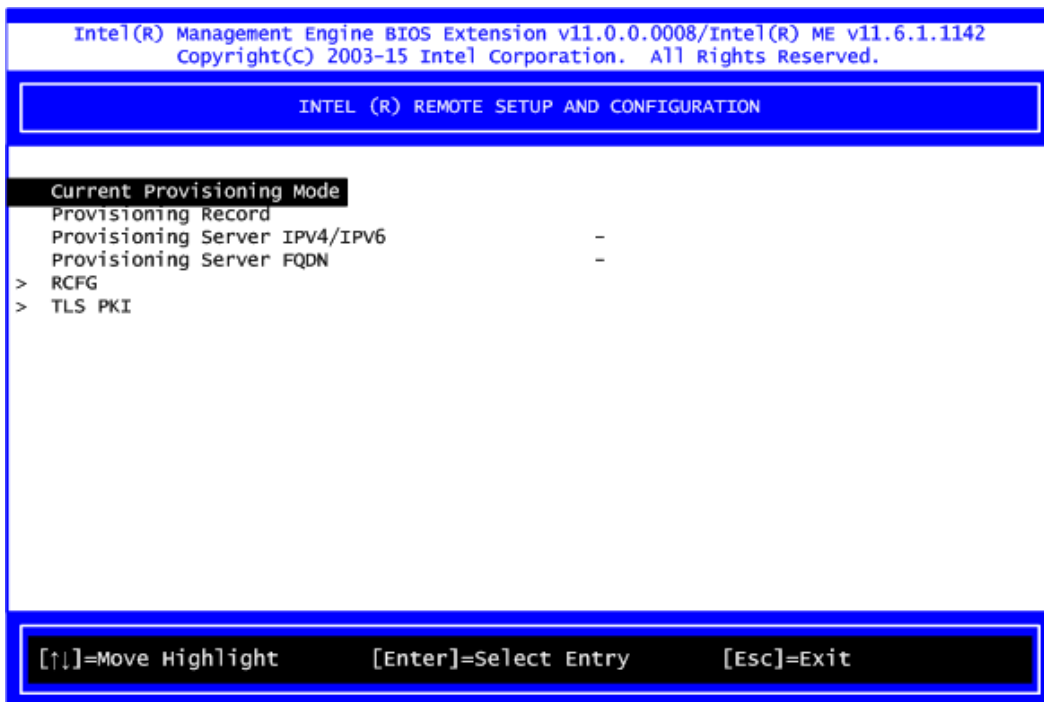

1. Select TLS PKI to get into remote configuration screen. Then select Start Configuration to activate it.

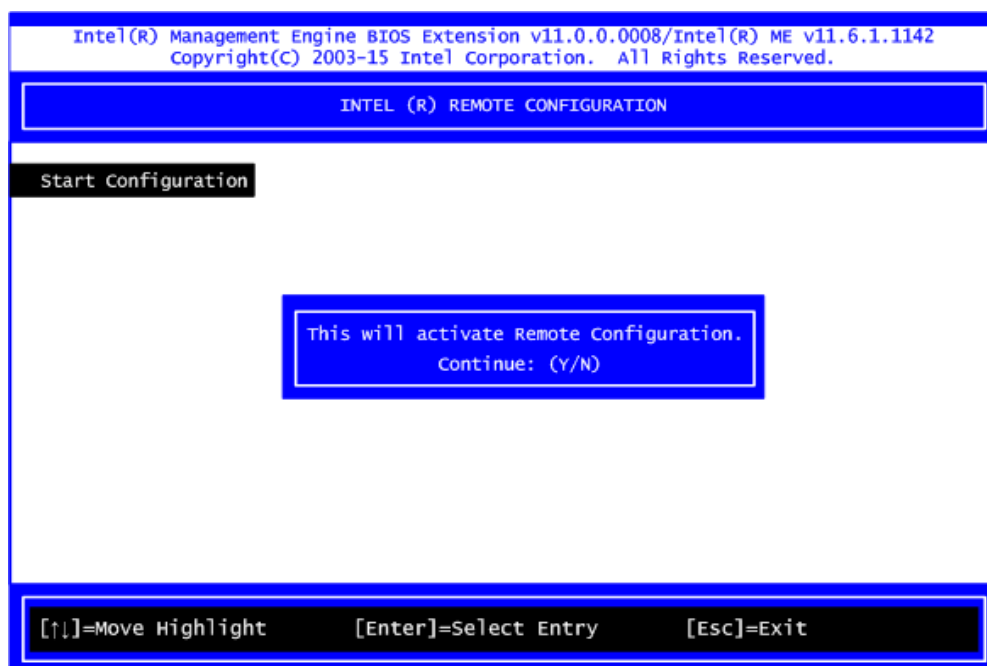

2. Select Manage Hashes to add, delete and activate hash.

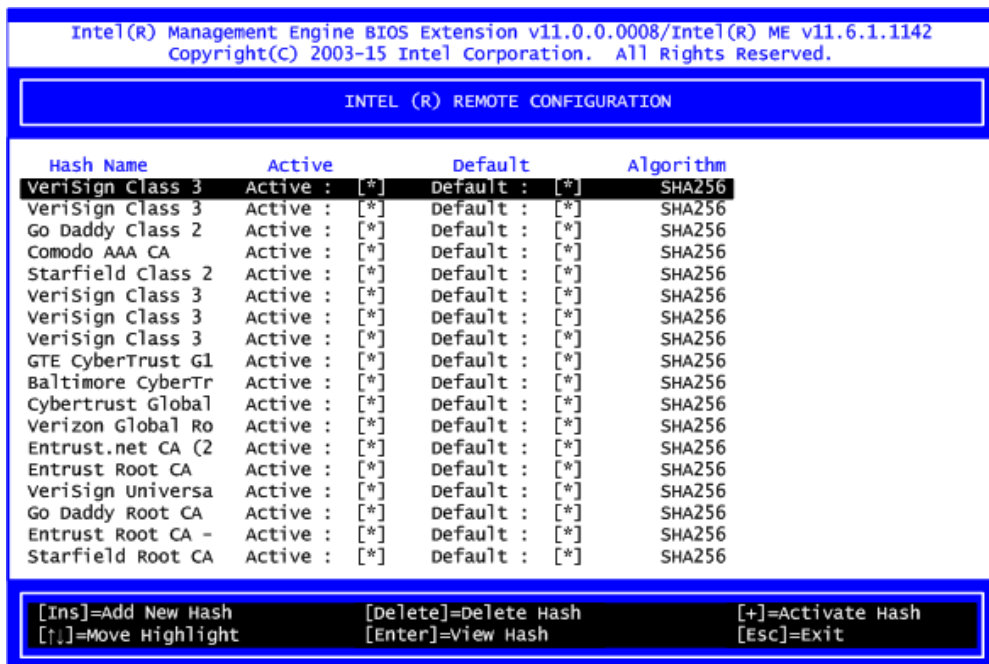
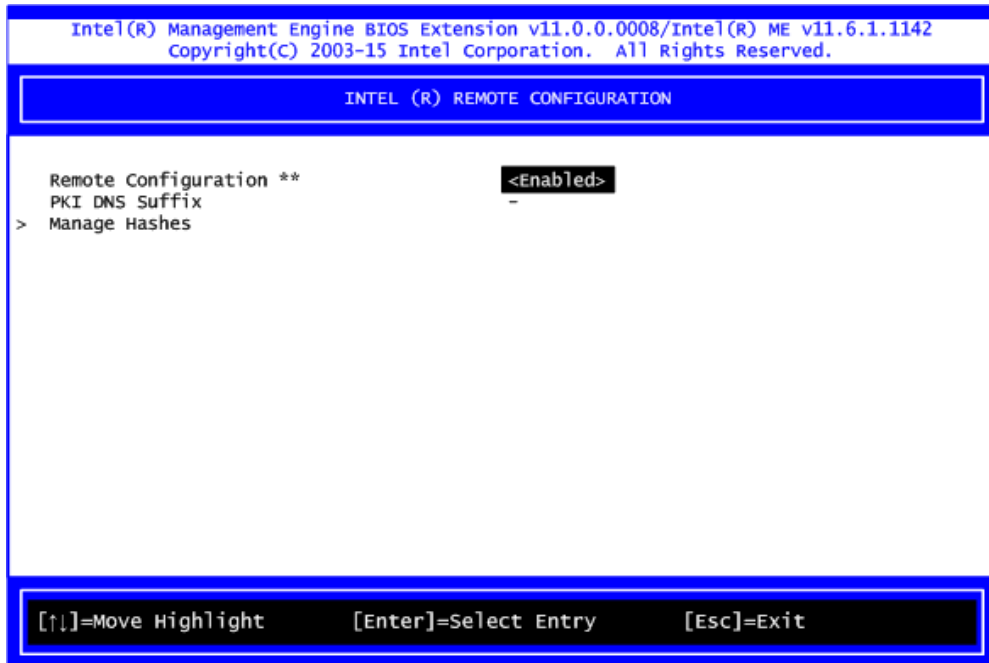

- **Power Control**

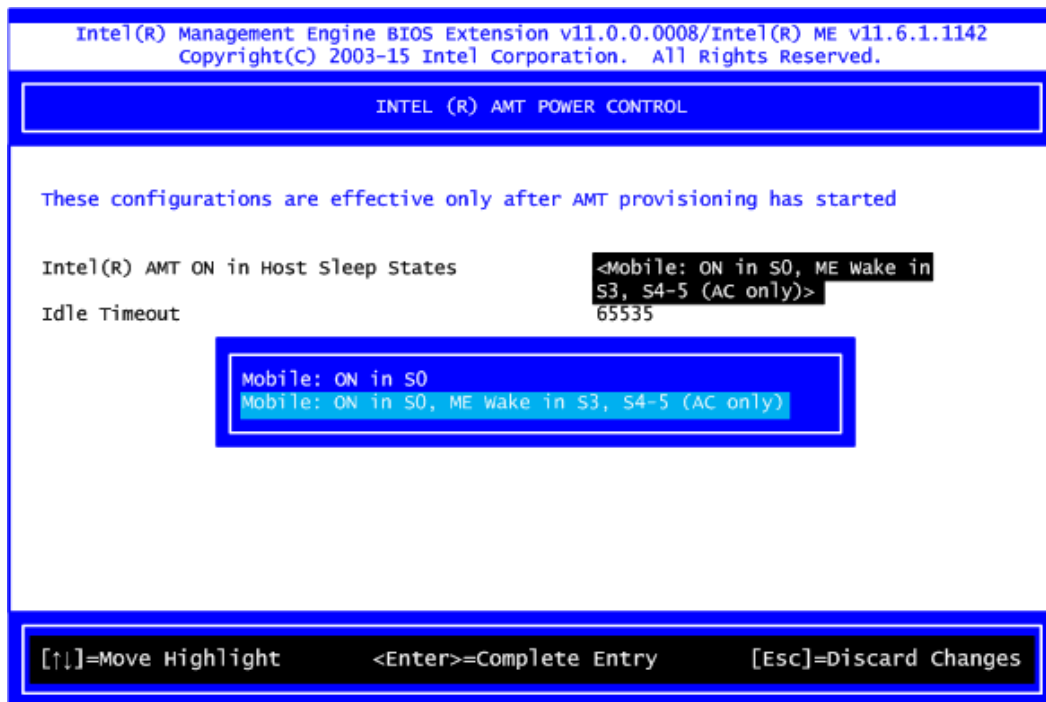

AMT ON in Host Sleep States

Select the appropriate AMT ON in Host Sleep States setting. Options are ON in S0 and ON in S0, ME Wake in S3, S4-5 (AC only).

Idle Timeout

This is timeout value for Wake_On_ME in minutes. It must be set to a non-zero value.

C.4 iAMT Web Console

1. From a web browser, please type [http://\(IP ADDRESS\):16992](http://(IP ADDRESS):16992), which connects to iAMT Web.

Example: <http://10.1.40.214:16992>

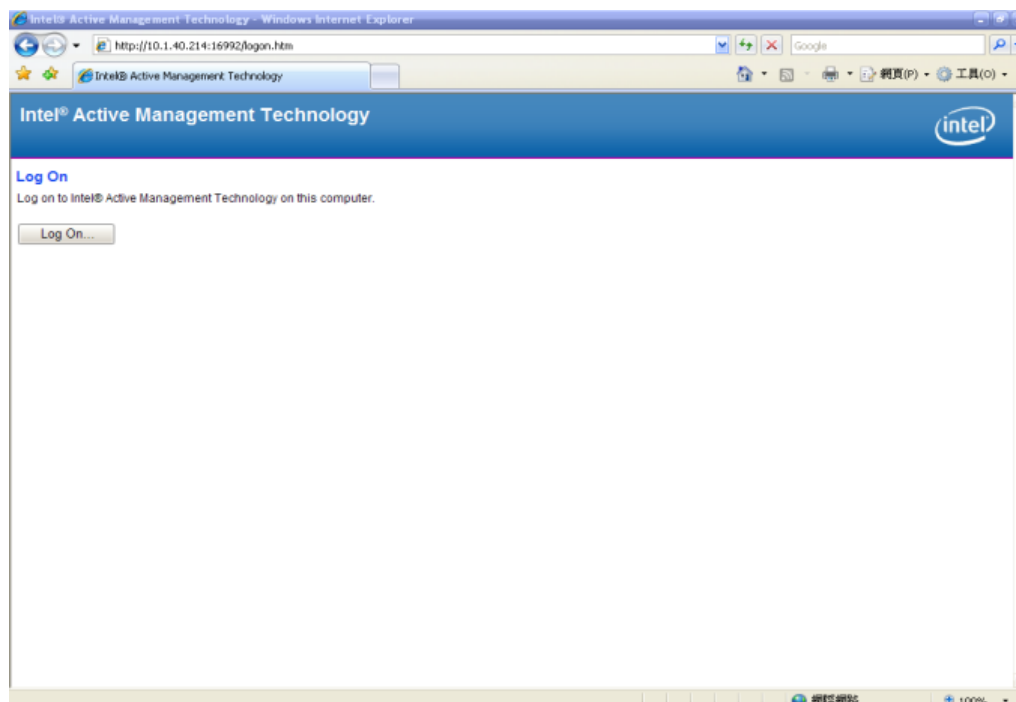

2. To log on, you will be required to type in username and password for access to the Web.

USER: admin (default value)

PASS: (MEBx password)

3. Enter the iAMT Web.

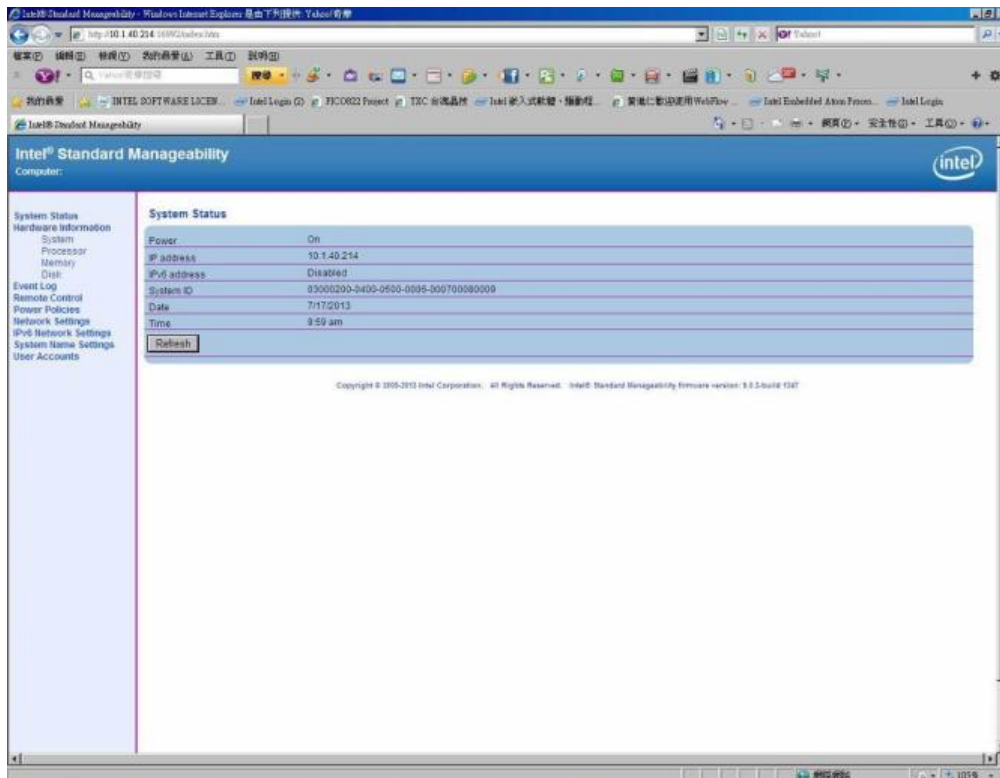

4. Click Remote Control, and select commands on the right side.

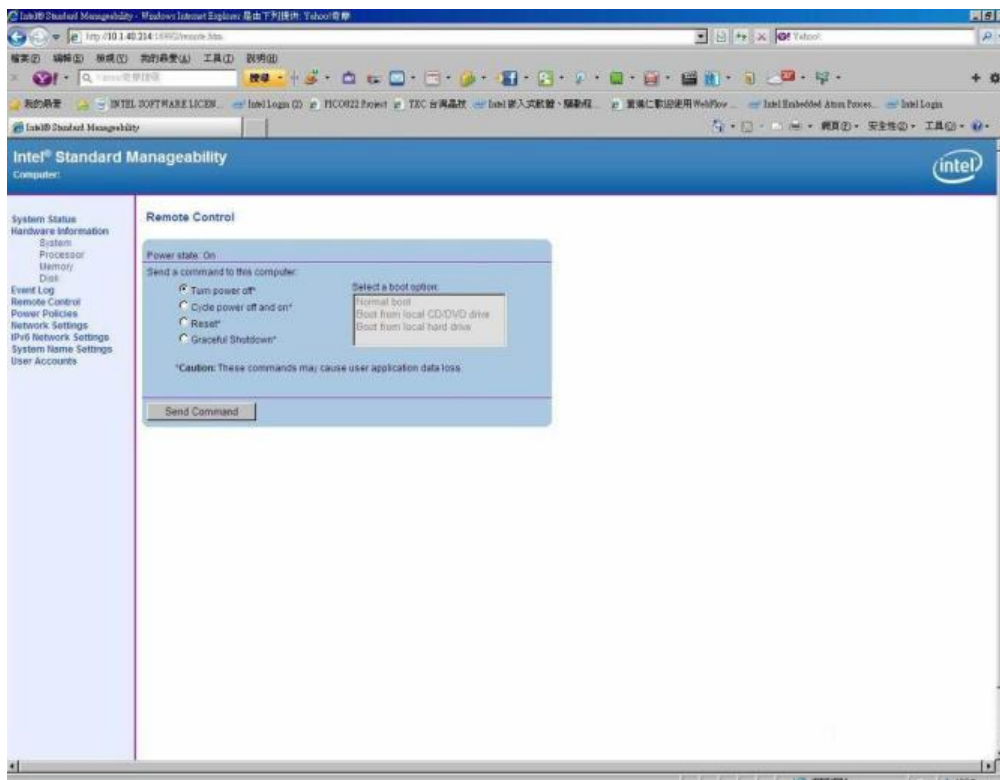

5. When you have finished using the iAMT Web console, close the Web browser.