

# USER'S MANUAL

## **AIE100-ONA Series**

Edge AI Embedded System

User's Manual



[www.axiomtek.com](http://www.axiomtek.com)

## **Disclaimers**

This manual has been carefully checked and believed to contain accurate information. Axiomtek Co., Ltd. assumes no responsibility for any infringements of patents or any third party's rights, or any liability arising from such uses.

Axiomtek does not warrant or assume any legal liability or responsibility for the accuracy, completeness or usefulness of any information in this document. Axiomtek does not make any commitment to update any information in this manual.

Axiomtek reserves the right to change or revise this document and/or product at any time without notice.

No part of this document may be reproduced, stored in a retrieval system, or transmitted in any forms or by any means, electronic, mechanical, photocopying, recording, among others, without prior written permissions of Axiomtek Co., Ltd.

**©Copyright 2023 Axiomtek Co., Ltd.**

**All Rights Reserved**

**September 2023, Version A1**

**Printed in Taiwan**

## Safety Precautions

Before getting started, please read the following important safety precautions.

1. The AIE100-ONA does not come with an operating system which must be loaded first before installation of any software into the computer.
2. Be sure to ground yourself to prevent static charge when installing any internal components. Use a wrist grounding strap and place all electronic components in any static-shielded devices. Most electronic components are sensitive to static electrical charge.
3. Disconnect the power cord from the AIE100-ONA prior to making any installation. Be sure both the system and all external devices are turned OFF. Sudden surge of power could ruin sensitive components. Make sure the AIE100-ONA is properly grounded.
4. Make sure the voltage of the power source is correct before connecting it to any power outlet.
5. Turn Off system power before cleaning. Clean the system using a cloth only. Do not spray any liquid cleaner directly onto the screen.
6. Do not leave equipment in an uncontrolled environment where the storage temperature is below  $-40^{\circ}\text{C}$  or above  $80^{\circ}\text{C}$  as it may damage the equipment.
7. Do not open the system's back cover. If opening the cover for maintenance is a must, only a trained technician is allowed to do so. Integrated circuits on computer boards are sensitive to static electricity. To avoid damaging chips from electrostatic discharge, observe the following precautions:
  - Before handling a board or integrated circuit, touch an unpainted portion of the system unit chassis for a few seconds. This will help discharge any static electricity on human body.
  - When handling boards and components, wear a wrist grounding strap available from most electronic component stores.
8. Note!! Caution with touch! AIE100-ONA will be hot when it's on.

## Classification

1. Degree of protection against electric shock: not classified
2. Degree of protection against ingress of water: IP40 (IP42 rating by optional cover kit)
3. Equipment not suitable for use in the presence of a flammable anesthetic mixture with air, oxygen or nitrous oxide.
4. Mode of operation: Continuous



**Note:** All of I/O connectors should be connected with corresponding cables when the system is operating with IP40 & IP42 rated definition. If some of I/O ports are not be used or connected during operation, users must to connect optional I/O covers to meet IP40 & IP42 standard.

## General Cleaning Tips

Please keep the following precautions in mind while understanding the details fully before and during any cleaning of the computer and any components within.

A piece of dry cloth is ideal to clean the device.

1. Be cautious of any tiny removable components when using a vacuum cleaner to absorb dirt on the floor.
2. Turn the system off before clean up the computer or any components within.
3. Avoid dropping any components inside the computer or getting circuit board damp or wet.
4. For cleaning, be cautious of all kinds of cleaning solvents or chemicals which may cause allergy to certain individuals.
5. Keep foods, drinks or cigarettes away from the computer.

### Cleaning Tools:

Although many companies have created products to help improve the process of cleaning computer and peripherals, users can also use house hold items accordingly for cleaning. Listed below are items available for cleaning computer or computer peripherals.

Pay special attention to components requiring designated products for cleaning as mentioned below.

- Cloth: A piece of cloth is the best tool to use when rubbing up a component. Although paper towels or tissues can be used on most hardware as well, it is recommended to use a piece of cloth.
- Water or rubbing alcohol: A piece of cloth may be somewhat moistened with water or rubbing alcohol before being rubbed on the computer. Unknown solvents may be harmful to plastic parts.
- Absorb dust, dirt, hair, cigarette and other particles outside of a computer can be one of the best methods of cleaning a computer. Over time these items may restrict the airflow in a computer and cause circuitry to corrode.
- Cotton swabs: Cotton swaps moistened with rubbing alcohol or water are applicable to reach areas in keyboard, mouse and other areas.
- Foam swabs: If possible, it is better to use lint free swabs such as foam swabs.



**Note:** It is strongly recommended that customer should shut down the system before start to clean any single components.

### Please follow the steps below:

1. Close all application programs;
2. Close operating software;
3. Turn off power switch;
4. Remove all devices;
5. Pull out power cable.

## **Scrap Computer Recycling**

If the computer equipment's needs the maintenance or are beyond repair, we strongly recommended that you should inform your Axiomtek distributor as soon as possible for the suitable solution. For the computers that are no longer useful or no longer working well, please contact your Axiomtek distributor for recycling and we will make the proper arrangement.

## **Trademarks Acknowledgments**

Axiomtek is a trademark of Axiomtek Co., Ltd.

IBM, PC/AT, PS/2, VGA are trademarks of International Business Machines Corporation.

Intel® and Pentium® are registered trademarks of Intel Corporation.

NVIDIA® and Jetson are registered trademarks of NVIDIA Corporation.

MS-DOS, Microsoft C and QuickBasic are trademarks of Microsoft Corporation.

Windows 10, Linux and other brand names and trademarks are the properties and registered brands of their respective owners.

# Table of Contents

---

Disclaimers.....	ii
Safety Precautions.....	iii
Classification.....	iv
General Cleaning Tips .....	v
Scrap Computer Recycling.....	vi
<b>SECTION 1 INTRODUCTION.....</b>	<b>1</b>
1.1    General Description .....	1
1.2    System Specifications .....	2
1.2.1    Product Specification .....	2
1.2.2    I/O System .....	3
1.2.3    System Specification.....	4
1.3    Dimensions .....	5
1.3.1    System Dimension.....	5
1.3.2    Wall mount Bracket Dimension (Screw: M3 *4L 4pcs) .....	6
1.3.3    Din-rail mount Bracket Dimension (Screw: M3 *4L 8pcs) .....	7
1.3.4    VESA arm mount Bracket Dimension (Screw: M3 *4L 4pcs) .....	8
1.4    I/O Outlets.....	9
1.5    Packing List.....	10
1.6    Model List .....	10
<b>SECTION 2 HARDWARE INSTALLATION .....</b>	<b>11</b>
2.1    Installing the PCI Express Mini Card .....	12
2.2    Installing LTE or Wi-Fi Antenna Cable.....	14
2.3    Installing the M.2 2280 Key M SSD Drive.....	17
<b>SECTION 3 JUMPER SETTING &amp; CONNECTOR .....</b>	<b>21</b>
3.1    Jumper & Connector Location .....	21
3.2    Connectors .....	23
3.2.1    Digital I/O Connector (CN2) (Optional) .....	24
3.2.2    HDMI Connector (CN4).....	24
3.2.3    USB2.0 & USB3.2 Gen2 Connector (CN5) .....	25
3.2.4    DC Power Jack w/ Screw (CN6).....	25
3.2.5    PCI-Express Mini Card Connector (SCN1) .....	26
3.2.6    M.2 2280 Key M PCIe x4 SSD slot (SCN2) .....	27
3.2.7    SIM Card Slot (SCN3) .....	28
3.2.8    Micro USB 2.0 Connector (Micro USB) (SCN4).....	28
3.2.9    Ethernet Ports (LAN1, LAN2).....	29
3.2.10    Power Button & Reset Button (SW1).....	30
3.2.11    AT/ATX Switch (SSW1) .....	30
3.2.12    Recovery Mode Switch (SSW2).....	30
3.2.13    Debug Port Connector (JP1) .....	31
3.2.14    CMOS Battery Interface (BAT1) .....	31
3.2.15    Power and Storage LED Indicator (LED1).....	31
<b>SECTION 4 JETPACK BSP FLASH METHOD.....</b>	<b>33</b>
4.1    Jetpack Flash Method.....	33
4.2    Image Information Inquiry Command.....	36
4.3    JTOP-Third-party Jetson Platform Monitor Tool.....	37

**This page is intentionally left blank.**



## SECTION 1 INTRODUCTION



This chapter contains general information and detailed specifications of the AIE100-ONA. The Chapter 1 includes the following sections:

- General Description
- System Specifications
- Dimensions
- I/O Outlets
- Packing List
- Model List

### 1.1 General Description

The AIE100-ONA is an embedded system with NVIDIA® Jetson Orin™ Nano Series supercomputer on a module to support Linux Ubuntu 20.04, suitable for the most enduring operation.

It features fanless design with full feature I/O, one 4 or 8 GB 128-bit LPDDR4x memory, and enhanced system dependability by built-in Watchdog Timer.

- **Features**

1. NVIDIA® Jetson Orin™ Nano (Up to 40 TOPS)
2. High AI computing performance for GPU-accelerated processing
3. Ideal for various edge AI applications at smart city and smart retail
4. Optional IP42 rating cover kit for semi-outdoor applications
5. Supports 1 USB 2.0, 1 USB 3.2 Gen2, 1 GbE LAN and 1 GbE PoE
6. JetPack supported

- **Reliable and Stable Design**

The AIE100-ONA adopts the advanced fanless system and supporting the PCIe4 NVMe through M.2 interface, which makes it especially suitable for AI computing environments, best for smart city, GPU-accelerated processing, edge computing and smart retail applications.

- **JetPack Supported**

The AIE100-ONA supports JetPack 5.1.1 or later. NVIDIA JetPack SDK is the most comprehensive solution for building AI applications.

JetPack supports Jetson AGX Orin™, Jetson Orin™ NX, Jetson Orin™ Nano, Jetson AGX Xavier™, Jetson Xavier™ NX, Jetson™ TX2 NX, Jetson™ Nano and Jetson TX2 series. It bundles all the Jetson platform software, including TensorRT, cuDNN, CUDA Toolkit, VisionWorks, GStreamer, and OpenCV, all built on top of L4T with LTS Linux kernel.

- **OS Supported**

The AIE100-ONA supports Linux Ubuntu 20.04.

- **High-performance NVMe SSD Storage Supported**

The AIE100-ONA supports one M.2 2280 Key M with PCI-Express 2.0 x4 interface.

## 1.2 System Specifications

### 1.2.1 Product Specification

- **NVIDIA Jetson SKU**

- NVIDIA® Jetson Orin™ Nano 4GB (20 TOPS)
- NVIDIA® Jetson Orin™ Nano 8GB (40 TOPS)

- **CPU**

- 6-core Arm® Cortex®-A78AE v8.2 64-bit CPU 1.5MB L2 + 4MB L3

- **GPU**

- 4GB: 512-core NVIDIA Ampere architecture GPU with 16 Tensor Cores
- 8GB: 1024-core NVIDIA Ampere architecture GPU with 32 Tensor Cores

- **Storage**

- One M.2 2280 M Key with PCI-Express 2.0 x4 NVMe SSD slot

\*Orin NX no longer has built-in eMMC and only supports SSD for the bootable device.

- **System Memory**

- 4GB: 4GB 64-bit LPDDR5 34 GB/s
- 8GB: 8GB 128-bit LPDDR5 68 GB/s

- **WLAN & WWAN**

- One PCI Express Mini Card modules slot to support Wi-Fi or 3G/4G/LTE modules

## 1.2.2 I/O System

- One HDMI 2.1 for display (Resolution: up to 3840x2160 @ 30 Hz)
- One RJ-45 connector for 10/100/1000 Base-T Ethernet port
- One RJ-45 connector for 10/100/1000 Base-T PoE (IEEE 802.3af; PSE), max. up to 15.4 Watts



**Note:** AIE100 is a power supply device. Two PSE devices should not be connected together, which may cause the risk of power conflict. Correctly connect PD Device or switch without PoE. If you need PoE switch, please find the switch with uplink port.

- One USB 2.0 and one USB 3.2 Gen2 connectors
- Front-access design for ease of updating NVIDIA Jetpack
  - One Micro USB connector for image flash only
  - One Recovery switch
- One M.2 2280 Key M with PCI-Express 2.0 x4 SSD slot for massive data processing  
\*Orin Nano no longer has built-in eMMC and only supports SSD for the bootable device.
- One full-size PCI Express Mini Card slot (USB + PCI Express signal)
- One Power button and one Reset button
- Two Indicators LEDs (System Power, M.2 Storage)
- Two SMA type connector openings for antenna
- One 12VDC Power Jack connector

### 1.2.3 System Specification

- **Watchdog Timer**
  - Built-in NVIDIA® Jetson Orin™ Nano
- **Power Supply**
  - Input : 12VDC
- **Operation Temperature**
  - -25°C to +70°C (-13°F to +158°F) (Power Mode: 15W)
- **Humidity**
  - 10% ~ 95% (non-condensation)
- **Vibration Endurance**
  - 3Grms w/ M.2 SSD Storage (5-500Hz, X, Y, Z directions)
- **Weight**
  - 1 kg(2.20lb) without package
  - 1.6 kg(3.52lb) with package
- **Dimensions**
  - 148.6 mm (5.85") (W) x 129.8 mm (5.11") (D) x 34.6 mm (1.36") (H)



**Note:** All specifications and images are subject to change without notice.

## 1.3 Dimensions

The following diagrams show you dimensions and outlines of the AIE100-ONA.

### 1.3.1 System Dimension

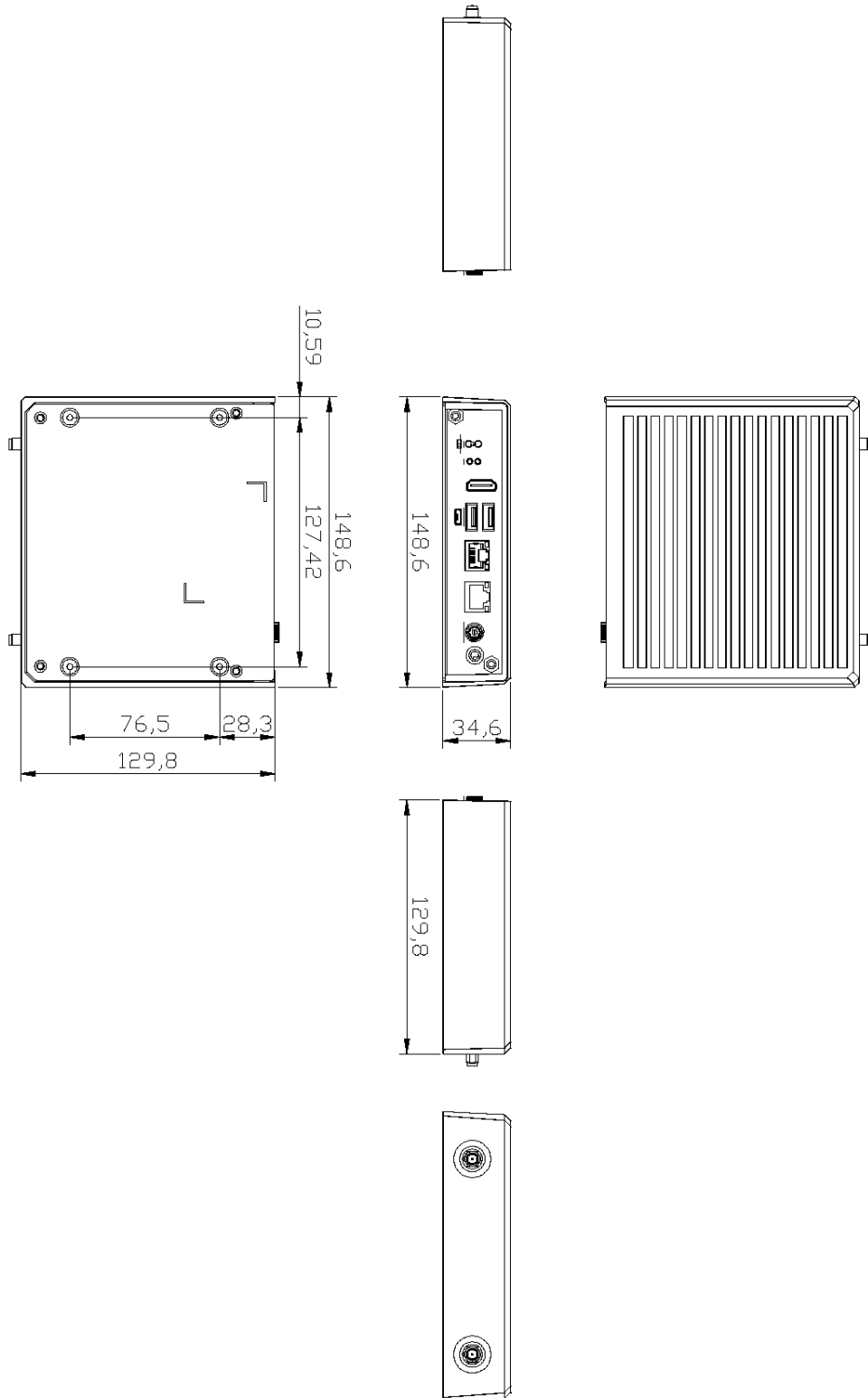

### 1.3.2 Wall mount Bracket Dimension (Screw: M3 \*4L 4pcs)

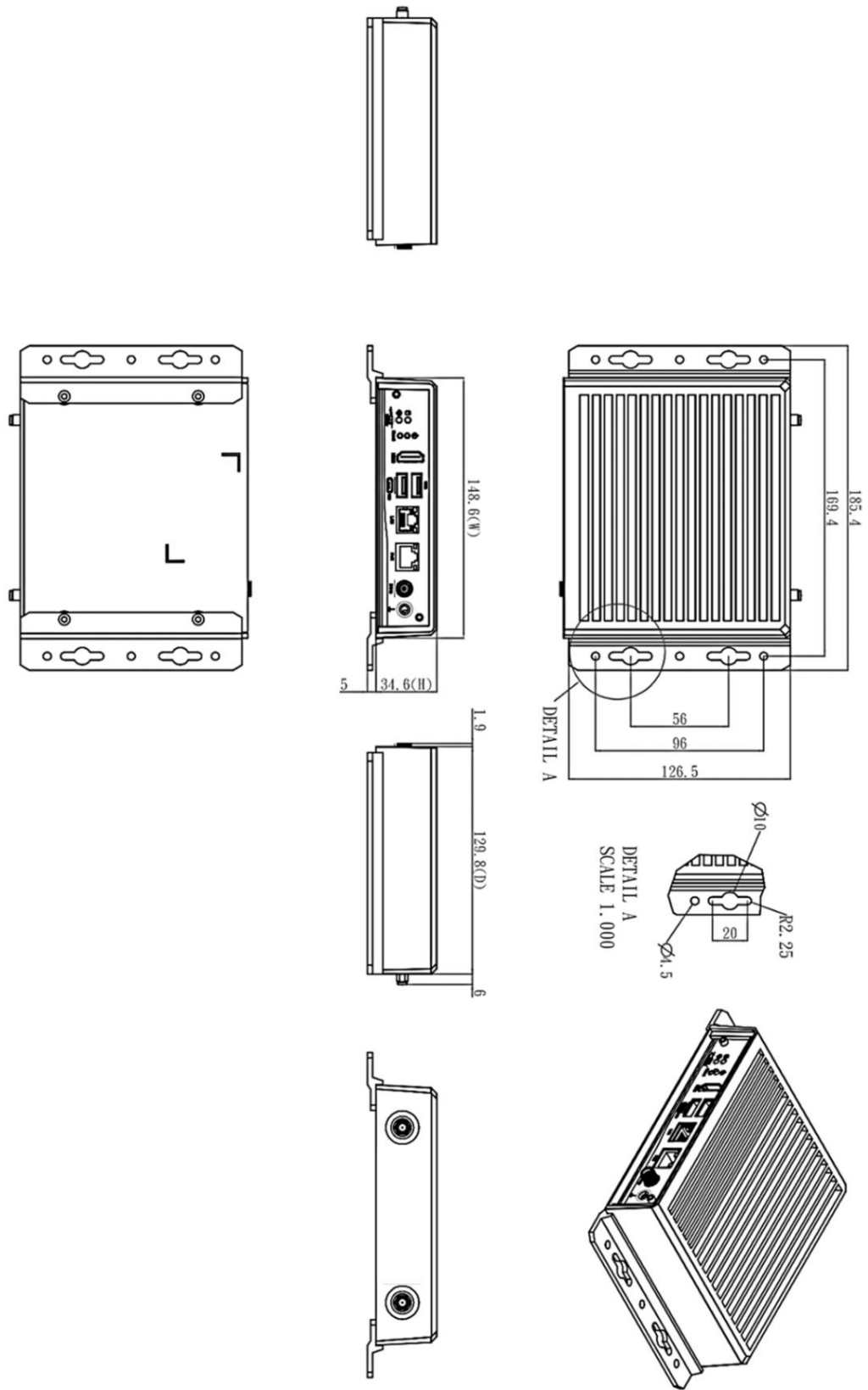

### 1.3.3 Din-rail mount Bracket Dimension (Screw: M3 \*4L 8pcs)

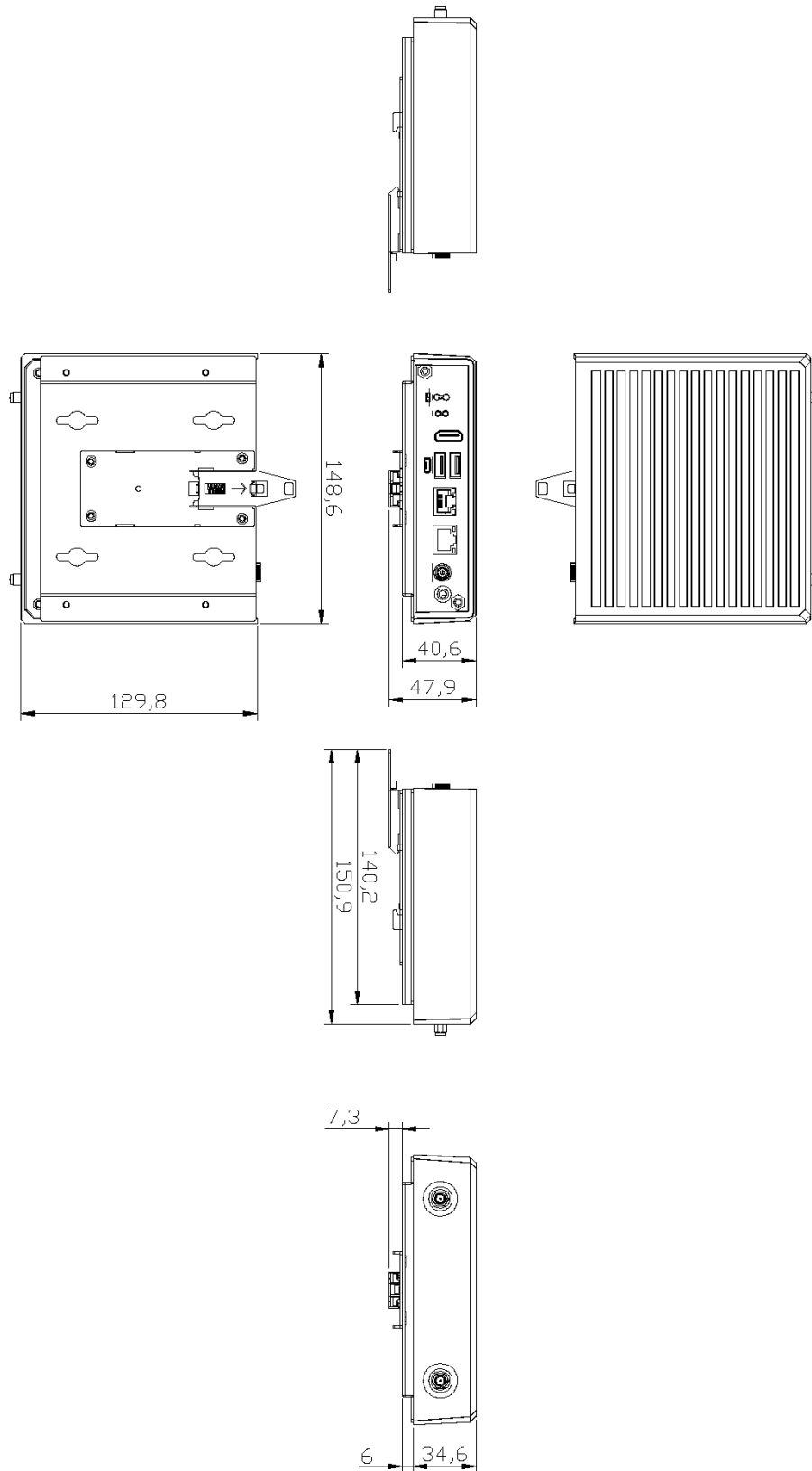

### 1.3.4 VESA arm mount Bracket Dimension (Screw: M3 \*4L 4pcs)

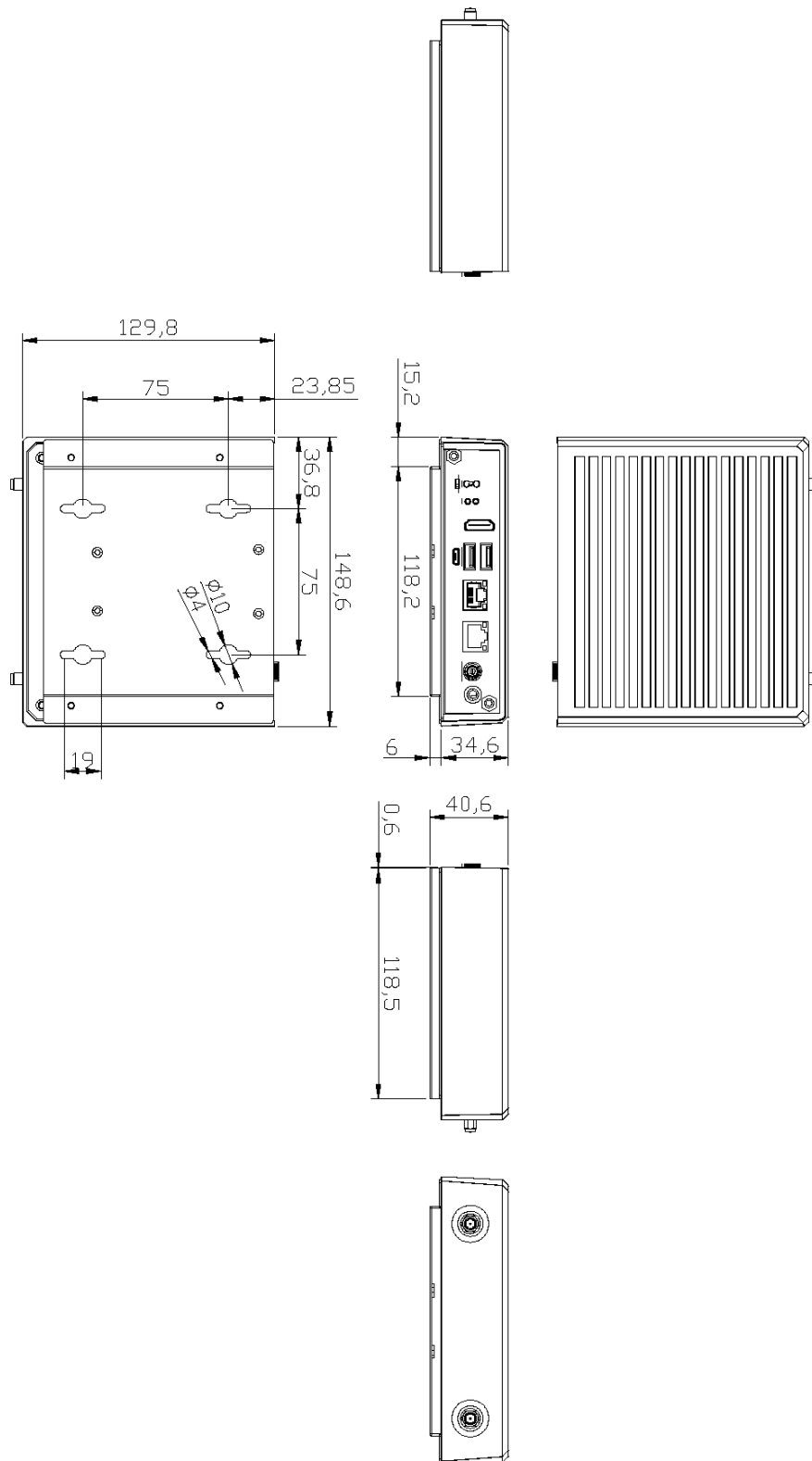



## 1.4 I/O Outlets

The following figures show you I/O outlets on front view of the AIE100-ONA.

- Front View drawing

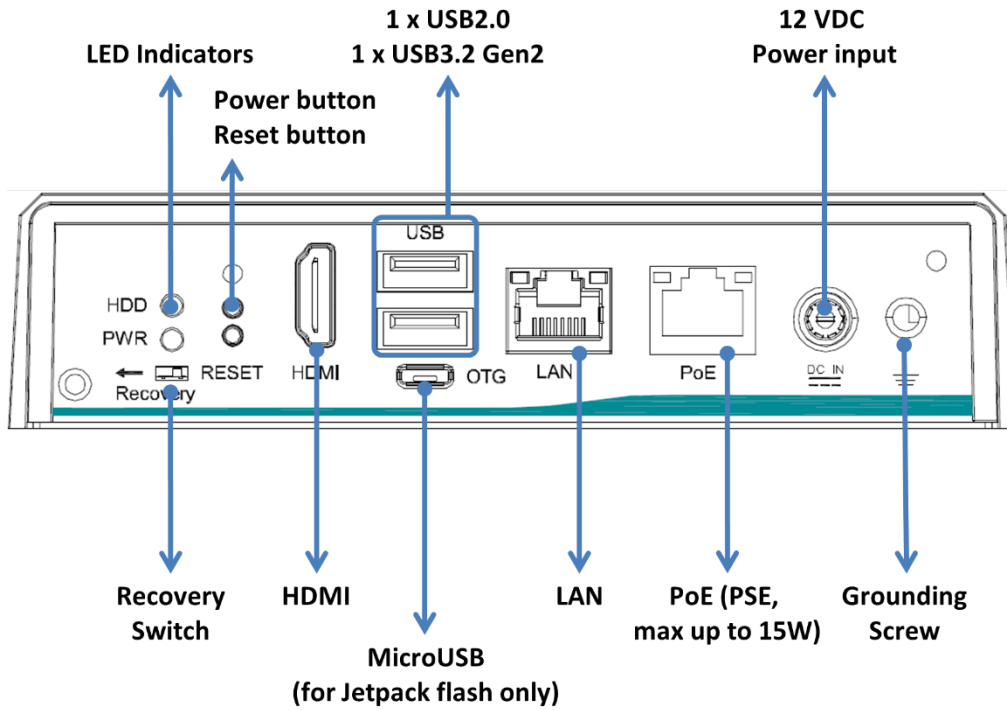

- Rear View drawing

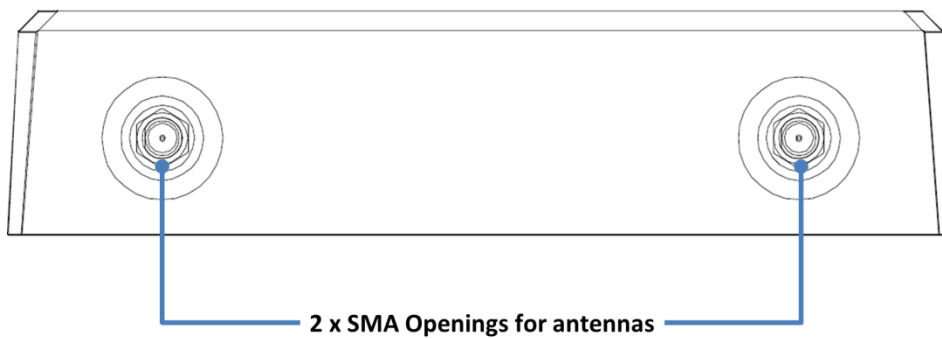

## 1.5 Packing List

The package bundled with your AIE100-ONA should contain the following items:

- **AIE100-ONA System Unit x 1**
- **Foot pad x 4**
- **Screws Pack x 1**
- **Thermal pad x 3 (for M.2 M-Key SSD)**

※Regarding the latest product manual, please download them from Axiomtek official website.

## 1.6 Model List

<b>AIE100-ONA-4GB</b>	Fanless Edge AI System with NVIDIA® Jetson Orin™ Nano 4GB, 1 HDMI, 1 GbE LAN, 1 GbE PoE and 2 USB
<b>AIE100-ONA-8GB</b>	Fanless Edge AI System with NVIDIA® Jetson Orin™ Nano 8GB, 1 HDMI, 1 GbE LAN, 1 GbE PoE and 2 USB

If you cannot find this package or any items are missing, please contact Axiomtek distributors immediately.

## SECTION 2 HARDWARE INSTALLATION

The AIE100-ONA is convenient for your various hardware configurations, such as SSD (Solid State Drive), and PCI Express Mini Card modules. The chapter 2 will show you how to install the hardware.

 **Note:** Waterproof capability of the IPX2 rating may be affected if a system is disassembled or improperly assembled; under such circumstances Axiomtek shall not be liable for any quality deterioration.

Besides assembling the optional IP42 rating cover kit, please refer to tightening torque below for all system screws and waterproof antenna connectors to ensure the waterproof capability:

⊙ Philips screws at bottom side: 6Kgf-cm



⊙ Waterproof antennas connector of SMA cables: 6Kgf-cm

 **Note:** To support the IP42 rating, AIE100-ONA must be installed with waterproof SMA cables.

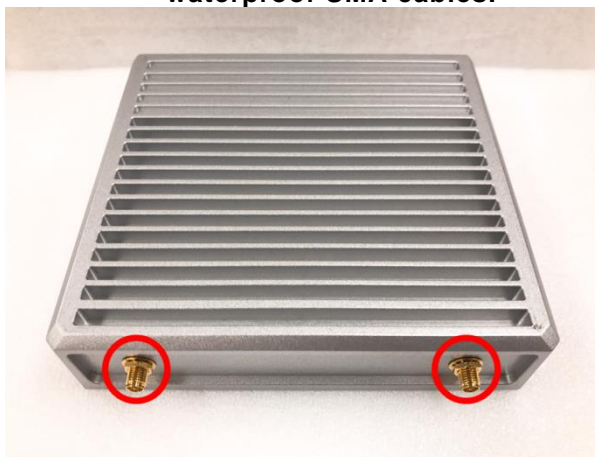

## 2.1 Installing the PCI Express Mini Card

**Step 1** Turn off the system, and unplug the power adaptor.

**Step 2** Turn the system upside down to locate screws at the bottom side as red marked and loosen four screws.



**Step 3** Remove the bottom cover, and locate PCI Express mini card slot on the board.



**Step 4** Holding the PCI Express mini card at a 45 degree angle up from horizontal, slowly insert the golden fingers into the PCI Express slot until it is fully inserted in.

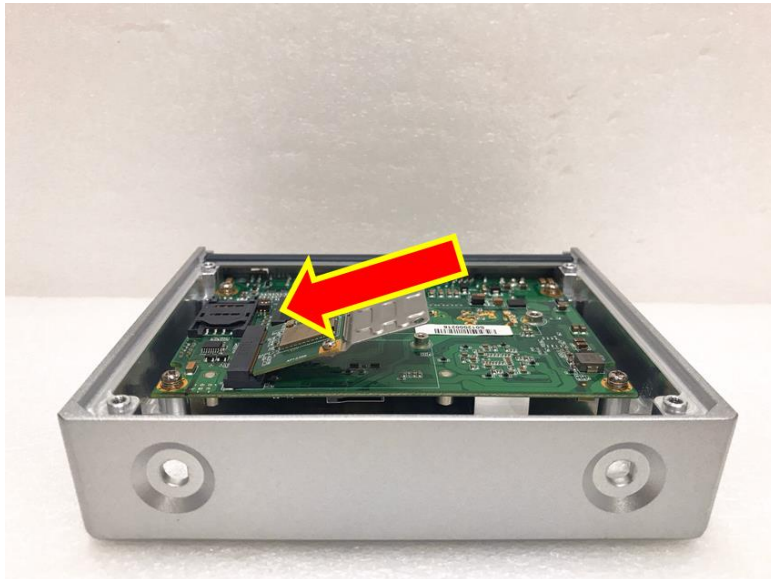

**Step 5** Press it down gently, but firmly, and then secure the PCI Express mini card to the carrier by tightening up the one M2 Phillips screw to the marked position.



## 2.2 Installing LTE or Wi-Fi Antenna Cable

**Step 1** Install the Mini PCIe card into the Mini PCIe slot and affix it with a screw. For more details, please refer to section 2.1: Installing the PCI Express Mini Card.



**Step 2** Take the Antenna kit out of its box, and remove the hex nut and washer from the Antenna cable.

 **Note:** The LTE and Wi-Fi module comes with the different type of SMA cable, one is IPEX, and another one is IPEX4, please do not mix and match them.

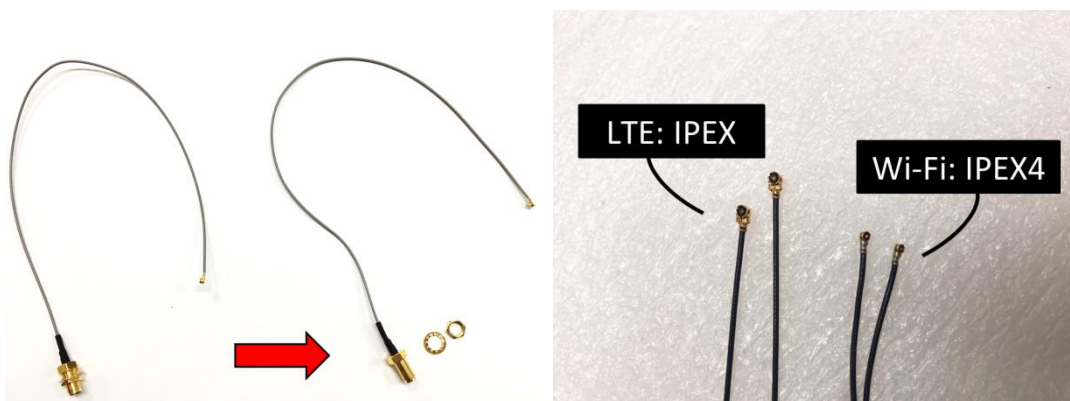

**Step 3** Install the antenna cable connector through the opening at the rear of the chassis.



**Step 4** Put the washer and Hex nut into the antenna cable connector, and tighten it up.





**Step 5 Connect the antenna cable to the PCI Express mini card.**

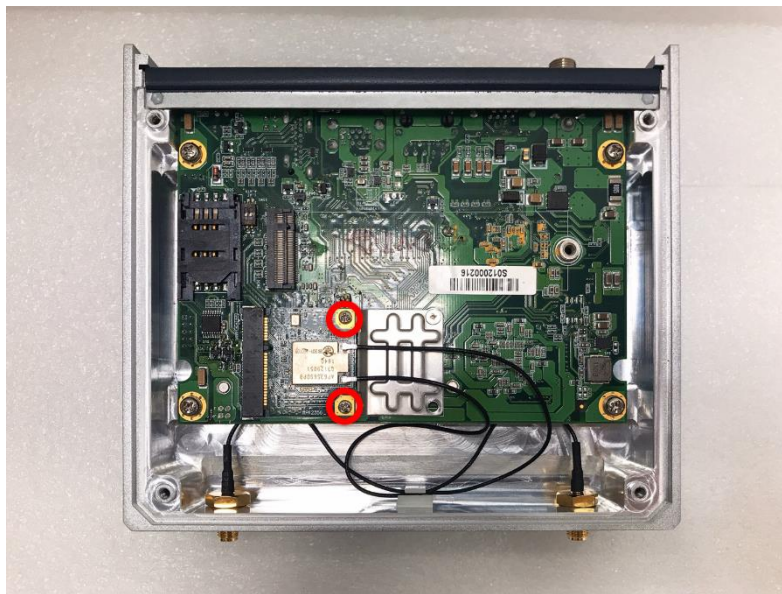



## 2.3 Installing the M.2 2280 Key M SSD Drive

**Step 1** Turn off the system, and unplug the power adaptor.

**Step 2** Turn the system upside down to locate screws at the bottom side as red marked and loosen four screws.



**Step 3** Remove the bottom cover, and locate the M.2 2280 Key M slot on the board.



**Step 4** Take 3pcs thermal pads out of its box.

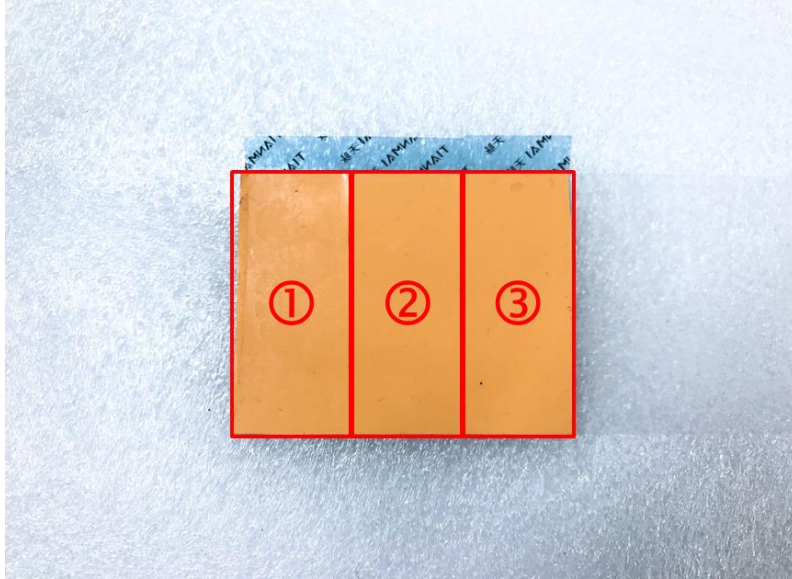

**Step 5** Apply one thermal pad on the M.2 2280 Key M slot.



**Step 6** Holding the M.2 2280 Key M SSD drive at a 30 degree angle up from horizontal, slowly insert the golden fingers into the M.2 2280 Key M slot until it is fully inserted in.



**Step 7** Press it down gently, but firmly, and then secure the M.2 2280 Key M SSD drive to the carrier by tightening up the one M3 Phillips head screw to the marked position.



**Step 8 Apply another two thermal pads on the M.2 2280 Key M SSD drive.**

 **Note:** The thickness of the SSD drive may be different by the different manufacturers, to avoid system damaged by forced closing of the bottom cover and improperly installed. Please check M.2 thickness first to decide to apply how many pieces thermal pads on the M.2 SSD Drive, or please install the M.2 SSD Drive suggested by Axiomtek.

 **Note:** Thermal Pads dimension: 60mm (L) x 25mm (W) x 2mm (H)



## SECTION 3 JUMPER SETTING & CONNECTOR

Proper jumper settings configure the **AIE100-ONA** to meet your application purpose. We are here with listing a summary table of all jumpers and default settings for onboard devices, respectively.

### 3.1 Jumper & Connector Location

SBC87903 Top View

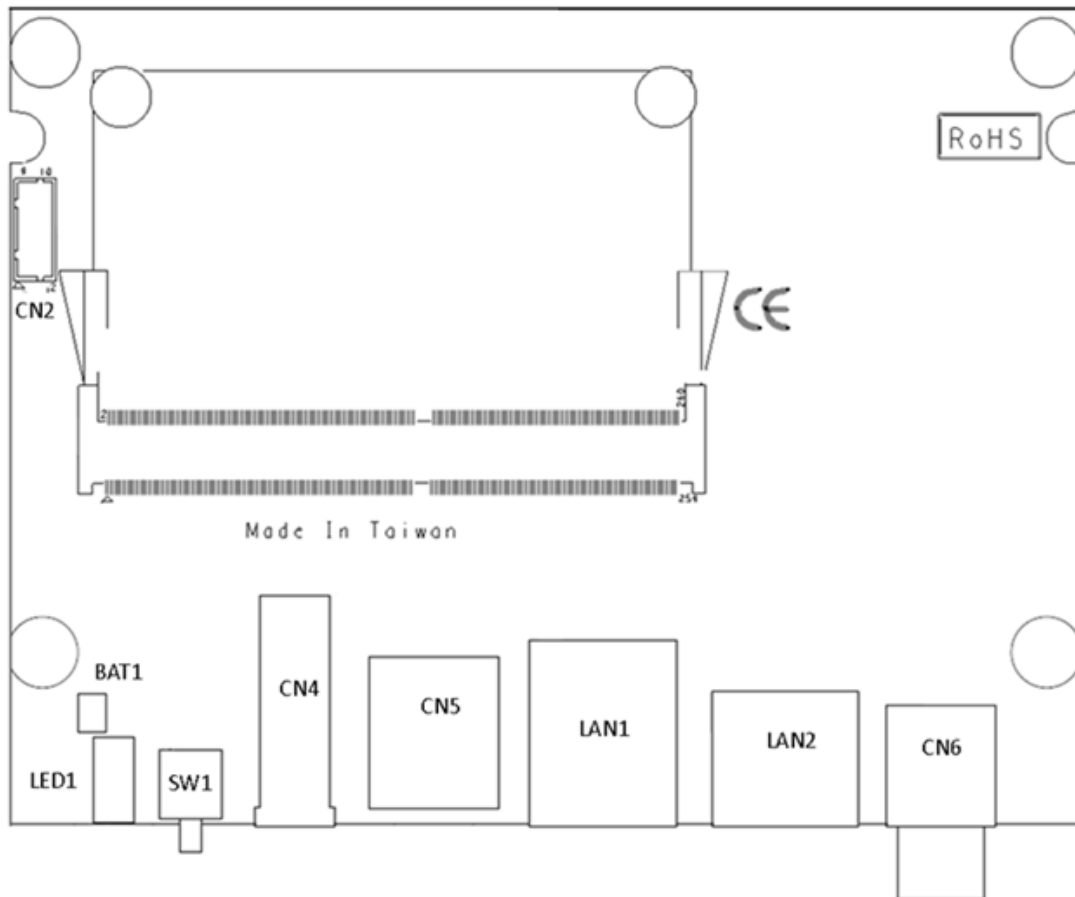

SBC87903 Bottom View

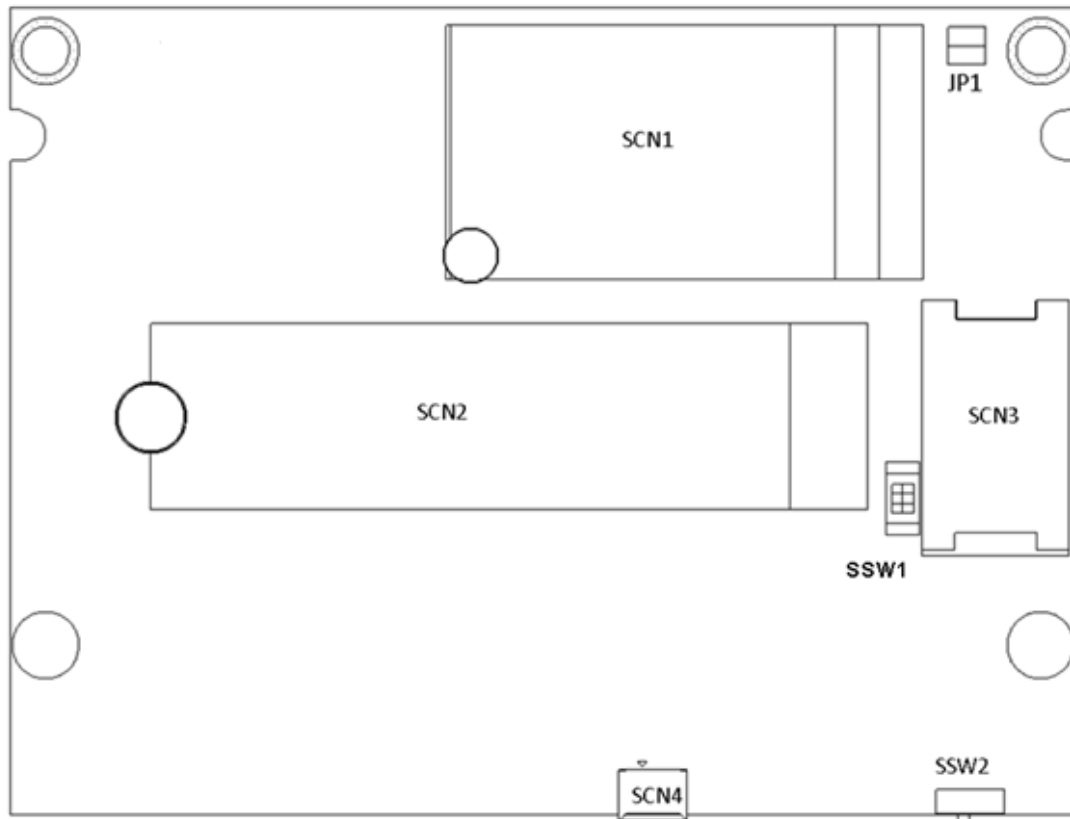

**Note:** We strongly recommended that you should not modify any unmentioned jumper setting without Axiomtek FAE's instruction. Any modification without instruction might cause damage to the system.

## 3.2 Connectors

Connectors connect the board with other parts of the system. Loose or improper connection might cause problems. Make sure all connectors are properly and firmly connected. Here is a summary table shows you all connectors and button on the **AIE100-ONA** Series.

External Connectors / Buttons	PCB Location	Section
Digital I/O Connector (Optional)	CN2	3.2.1
HDMI Connector	CN4	3.2.2
USB2.0 & USB3.2 Gen2 Connector	CN5	3.2.3
DC-in Connector	CN6	3.2.4
PCI-Express Mini Card slot	SCN1	3.2.5
M.2 2280 Key M PCIe x4 SSD slot	SCN2	3.2.6
SIM Card Slot	SCN3	3.2.7
Micro USB 2.0 Connector (For Jetpack flash only)	SCN4	3.2.8
Ethernet Ports	LAN1	3.2.9
PoE Ports	LAN2	3.2.10
Power Button & Reset Button	SW1	3.2.10
AT/ATX Switch	SSW1	3.2.11
Recovery Mode Switch	SSW2	3.2.12
Debug Port Connector	JP1	3.2.13
CMOS Battery Interface	BAT1	3.2.14
Power and Storage LED Indicator	LED1	3.2.15

### 3.2.1 Digital I/O Connector (CN2) (Optional)

The AIE100-ONA supports one 8-Channel digital I/O connector by option.

The digital I/O is controlled via software programming.

Pin	Signal	Pin	Signal
1	DIO1	2	DIO2
3	DIO3	4	DIO4
5	DIO5	6	DIO6
7	DIO7	8	DIO8
9	+5V_SBY	10	GND

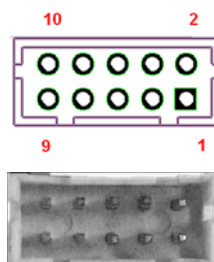

### 3.2.2 HDMI Connector (CN4)

The HDMI (High-Definition Multimedia Interface) is a compact digital interface which is capable of transmitting high-definition video and high-resolution audio over a single cable.

Pin	Signal	Pin	Signal
1	HDMI1_DATA2+	2	GND
3	HDMI1_DATA2-	4	HDMI1_DATA1+
5	GND	6	HDMI1_DATA1-
7	HDMI1_DATA0+	8	GND
9	HDMI1_DATA0-	10	HDMI1_CLK+
11	GND	12	HDMI1_CLK-
13	HDMI_CEC	14	NC
15	HDMI1_SCL	16	HDMI1_SDA
17	GND	18	+5V
19	HDMI_HTPLG		

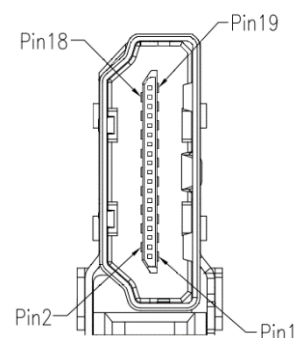



### 3.2.3 USB2.0 & USB3.2 Gen2 Connector (CN5)

The Universal Serial Bus connectors are compliant with USB 2.0 (480Mbps) and USB 3.2 Gen2 (10Gbps), and ideally for installing USB peripherals such as keyboard, mouse, scanner, etc.

Pin	Signal	Pin	Signal
1	5V_USB1	7	GND
2	USB1_D-	8	USB_SS1_TX-
3	USB1_D+	9	USB_SS1_TX+
4	GND	10	5V_USB2
5	USB_SS1_RX-	11	USB2_D-
6	USB_SS1_RX+	12	USB2_D+
13	GND		

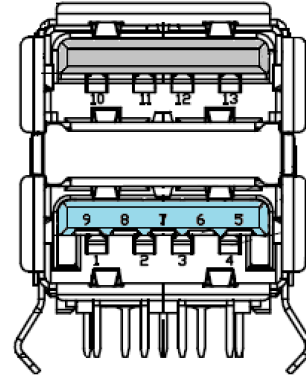

### 3.2.4 DC Power Jack w/ Screw (CN6)

The CN6 is a DC jack with screw. Firmly insert at least 60W adapter into this connector. Loose connection may cause system instability and make sure all components/devices are properly installed before connecting.

Pin	Signal
1	12V
2	GND

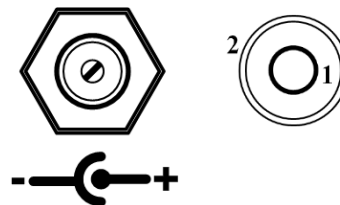

### 3.2.5 PCI-Express Mini Card Connector (SCN1)

The AIE100-ONA supports a full-size PCI-Express Mini Card slots. SCN1 is applying to either PCI-Express or USB 2.0 signal, and complies with PCI-Express Mini Card Spec. V1.2.

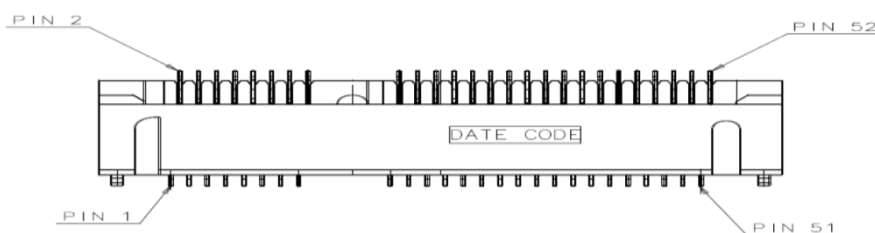

Pin	Signal	Pin	Signal	Pin	Signal	Pin	Signal
1	WAKE#	2	+3.3V	3	NC	4	GND
5	NC	6	+1.5V	7	CLKREQ#	8	UIM_PWR
9	GND	10	UIM_DATA	11	REFCLK-	12	UIM_CLK
13	REFCLK+	14	UIM_RESET	15	GND	16	UIM_VPP
17	NC	18	GND	19	NC	20	WLAN_DISABLE# / Orin™ Nano's GPIO05
21	GND	22	NC	23	PEX2_RX-	24	+3.3V
25	PEX2_RX+	26	GND	27	GND	28	+1.5V
29	GND	30	NC	31	PEX2_TX-	32	NC
33	PEX2_TX+	34	GND	35	GND	36	USB2.0_D-
37	GND	38	USB2.0_D+	39	+3.3V	40	GND
41	+3.3V	42	LED_WWAN#	43	GND	44	NC
45	NC	46	NC	47	NC	48	+1.5V
49	NC	50	GND	51	NC	52	+3.3V

### 3.2.6 M.2 2280 Key M PCIe x4 SSD slot (SCN2)

The AIE100-ONA comes with one M.2 2280 Key M PCIe x4 NVMe SSD slot for storage.

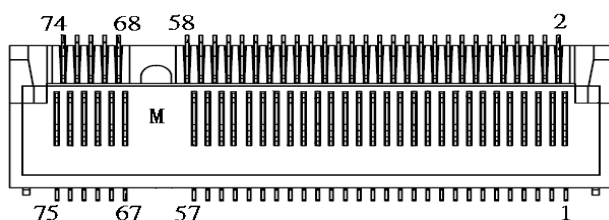

Pin	Signal	Pin	Signal	Pin	Signal	Pin	Signal
1	GND	2	+3.3V	3	GND	4	+3.3V
5	PEX3_RX-	6	NC	7	PEX3_RX+	8	NC
9	GND	10	LED_1#	11	PEX3_TX-	12	+3.3V
13	PEX3_TX+	14	+3.3V	15	GND	16	+3.3V
17	PEX2_RX-	18	+3.3V	19	PEX2_RX+	20	NC
21	GND	22	NC	23	PEX2_TX-	24	NC
25	PEX2_TX+	26	NC	27	GND	28	NC
29	PEX1_RX-	30	NC	31	PEX1_RX+	32	NC
33	GND	34	NC	35	PEX1_TX-	36	NC
37	PEX1_TX+	38	M.2_DEVSLP	39	GND	40	NC
41	PEX0_RX-	42	NC	43	PEX0_RX+	44	NC
45	GND	46	NC	47	PEX0_TX-	48	NC
49	PEX0_TX+	50	PERST#	51	GND	52	CLKREQ#
53	PEX0_REFCLK <sub>n</sub>	54	PEWAKE#	55	PEX0_REFCLK <sub>p</sub>	56	NC
57	GND	58	NC	59	CONNECTOR Key M	60	CONNECTOR Key M
61	CONNECTOR Key M	62	CONNECTOR Key M	63	CONNECTOR Key M	64	CONNECTOR Key M
65	CONNECTOR Key M	66	CONNECTOR Key M	67	NC	68	NC
69	NC	70	+3.3V	71	GND	72	+3.3V
73	GND	74	+3.3V	75	GND		

### 3.2.7 SIM Card Slot (SCN3)

AIE100-ONA comes with SIM Card Slot (SCN3) for inserting SIM Card. In order to work properly, the SIM Card must be used together with 3G/LTE module which would be inserted to PCI-Express Mini Card Connector (SCN1). It is mainly used for 3G/LTE wireless network application.

Pin	Signal	Pin	Signal
1	UIM PWR	5	GND
2	UIM RST	6	UIM VPP
3	UIM CLK	7	UIM DATA
4	NC	8	NC

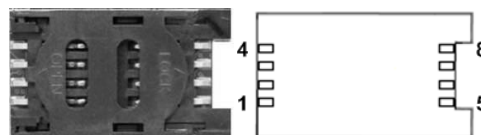

### 3.2.8 Micro USB 2.0 Connector (Micro USB) (SCN4)

The SCN4 is specifically designed for image flashing only. To flash Jetpack, please switch SSW2 to ON before booting up the system, which would force the system to recovery mode.

Pin	Signal
1	+5V
2	USB0 DN
3	USB0 DP
4	GND
5	GND

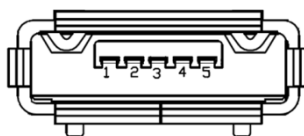

### 3.2.9 Ethernet Ports (LAN1, LAN2)

The AIE100-ONA comes with two RJ-45 connectors: LAN1 (NVIDIA® Jetson Orin™ Nano) and LAN2 (Intel® I210-IT). LAN1 is a GbE port, but LAN2 is the GbE PoE port (non-isolated), which is compliant IEEE 802.3af class 3, and the total power budget is 15Watts maximum.

LAN1		LAN2 (PoE)	
Pin	Signal	Pin	Signal
1	Tx+(Data transmission positive)	1	Tx+ (Data transmission positive)
2	Tx-(Data transmission negative)	2	Tx- (Data transmission negative)
3	Rx+(Data reception positive)	3	Rx+(Data reception positive)
4	RJ-1(For 1000 base T-Only)	4	RJ-1(For 1000 base T-Only)
5	RJ-1(For 1000 base T-Only)	5	RJ-1(For 1000 base T-Only)
6	Rx- (Data reception negative)	6	Rx- (Data reception negative)
7	RJ-1(For 1000 base T-Only)	7	RJ-1(For 1000 base T-Only)
8	RJ-1(For 1000 base T-Only)	8	RJ-1(For 1000 base T-Only)
A	Active LED	A	Active LED
B	Speed LED (1000M)	B	Speed LED (1000M / 100M)

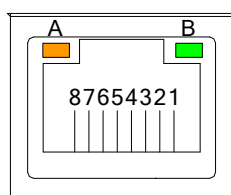

### 3.2.10 Power Button & Reset Button (SW1)

Power button can allow users to either turn on the AIE100-ONA or forcibly shut down the system, and the reset button can allow users to reset AIE100-ONA during system abnormal situation.

Pin	Signal
1	GND
2	GND
3	RST_BTN
4	PWR_BTN
5	GND
6	GND

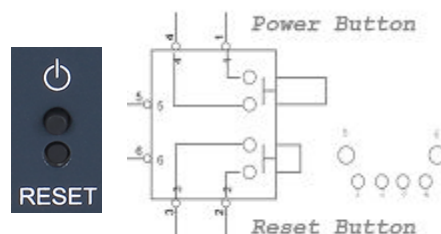

### 3.2.11 AT/ATX Switch (SSW1)

If you turn OFF the Pin1 (AT mode) of SSW1, the system will be automatically power on without pressing soft power button during power input; we can use this switch to achieve auto power on demand.

Pin	Description	ON (Default)	OFF
1	AT / ATX Mode	ATX	AT
2	NC	NC	NC

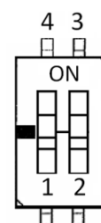

### 3.2.12 Recovery Mode Switch (SSW2)

It will make NVIDIA® Jetson Orin™ Nano force recovery mode when switching SSW2 to ON before booting up the system.

Pin	Signal
ON	Recovery Mode
OFF	Normal

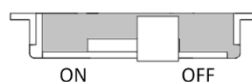

### 3.2.13 Debug Port Connector (JP1)

The JP1 is the serial debug port (UART Port0) for debugging purposes at software development.

Pin	Signal
1	+5V
2	UART2_TXD_3.3V
3	GND
4	UART2_RXD_3.3V

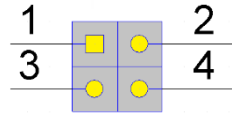

### 3.2.14 CMOS Battery Interface (BAT1)

This connector is for CMOS battery interface.

Pin	Signal
1	+VBAT
2	GND

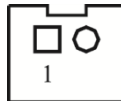

### 3.2.15 Power and Storage LED Indicator (LED1)

The Yellow LED is linked to Solid-state Drive (SSD) activity signal. LED flashes every time SSD is accessed. The power LED (Green) lights up and will remain steady while the system is powered on.

LED Color	Description
Yellow	Solid-state drive activity
Green	Power on/off



**This page is intentionally left blank.**



## SECTION 4

# JETPACK BSP FLASH METHOD

This chapter provides users with a detailed description of how to flash NVIDIA Jetpack BSP for AIE100-ONA, the user could follow the below instruction to install or reinstall Jetpack BSP by themselves.

### 4.1 Jetpack Flash Method

Please use the following instructions to flash the JetPack to the AIE100-ONA.

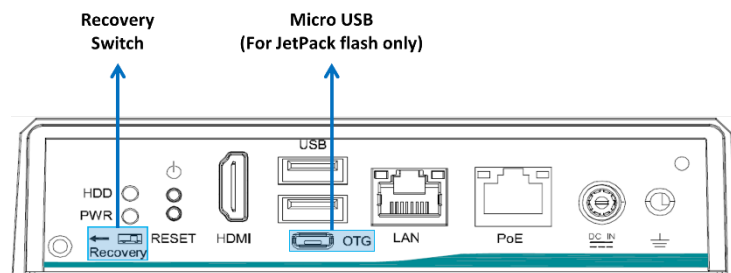

Please contact our sales or FAE for the latest Jetpack SDK, and prepare a Linux host system running x86\_64 Ubuntu v18.04 or later.

**Note:** If the Linux host system is running x86\_64 Ubuntu v18.04, please follow the instructions below to install Python first.

- Step 1. Connect the Linux host system to internet
- Step 2. Install Python with the command below:

```
sudo apt-get update
sudo apt-get install python
```

Step1. AIE100-ONA connection as follows:

- Connect a USB cable from the Linux host system to the Micro USB port at AIE100-ONA, and switch the recovery switch to ON. For more details, please refer to [3.2.12 Recovery Mode Switch \(SSW2\)](#).
- Connect an HDMI monitor to AIE100-ONA.

Step2. Open the terminal at the host system, and change the path to the image file directory, e.g., “~/Downloads”, and check image tarball data integrity with the following commands:

```
$ cd ~/Downloads
$ md5sum -c <image_tarball_file_name>.tbz2.md5sum
```

**Command Example:**

```
$ md5sum -c mfi_jetson-orin-nano-8GB-JP5.1.1-SBC87903-V1.0.0.tbz2.md5sum
```

```
axio@axio-desktop:/media/axio/Backup/ImageINS/SBC87903-A20/ONA/JP5.1.1/20230824_mfi_jetson-orin-nano-8GB-JP5.1.1-SBC87903-V1.0.0$ md5sum -c mfi_jetson-orin-nano-8GB-JP5.1.1-SBC87903-V1.0.0.tbz2.md5sum
mfi_jetson-orin-nano-8GB-JP5.1.1-SBC87903-V1.0.0.tbz2: OK
axio@axio-desktop:/media/axio/Backup/ImageINS/SBC87903-A20/ONA/JP5.1.1/20230824_mfi_jetson-orin-nano-8GB-JP5.1.1-SBC87903-V1.0.0$
```

Step3. If the check result returns OK, untar the image file with the command below:

```
$ tar jxvf <image_tarball_file_name>.tbz2
```



**Command Example:**

```
$ tar jxvf mfi_jetson-orin-nano-8GB-JP5.1.1-SBC87903-V1.0.0.tbz2
```

```
axio@axio-desktop:/media/axio/Backup/ImageINS/SBC87903-A20/ONA/JP5.1.1/20230824_mfi_jetson-orin-nano-8GB-JP5.1.1-SBC87903-V1.0.0$ tar jxvf mfi_jetson-orin-nano-8GB-JP5.1.1-SBC87903-V1.0.0.tbz2
```

Step4. Change the directory to the image package folder with the command below:

```
$ cd <image_file_name>
```



**Command Example:**

```
$ cd mfi_jetson-orin-nano-8GB-JP5.1.1-SBC87903-V1.0.0
```

```
axio@axio-desktop:/media/axio/Backup/ImageINS/SBC87903-A20/ONA/JP5.1.1/20230824_mfi_jetson-orin-nano-8GB-JP5.1.1-SBC87903-V1.0.0$ cd mfi_jetson-orin-nano-8GB-JP5.1.1-SBC87903-V1.0.0
axio@axio-desktop:/media/axio/Backup/ImageINS/SBC87903-A20/ONA/JP5.1.1/20230824_mfi_jetson-orin-nano-8GB-JP5.1.1-SBC87903-V1.0.0/mfi_jetson-orin-nano-8GB-JP5.1.1-SBC87903-V1.0.0$
```

Step5. Make sure the recovery switch(SSW2) has been switched to ON, and run the command lsusb, then the command line "0955:7523 Nvidia Corp." should be listed.

```
$ lsusb
```

```
axio@axio-desktop:~/Downloads$ lsusb
Bus 002 Device 001: ID 1d6b:0003 Linux Foundation 3.0 root hub
Bus 001 Device 008: ID 045e:00cb Microsoft Corp. Basic Optical Mouse v2.0
Bus 001 Device 039: ID 067b:2303 Prolific Technology, Inc. PL2303 Serial Port
Bus 001 Device 002: ID 067b:2303 Prolific Technology, Inc. PL2303 Serial Port
Bus 001 Device 082: ID 0955:7523 NVidia Corp.
Bus 001 Device 010: ID 05e3:0608 Genesys Logic, Inc. Hub
Bus 001 Device 036: ID 1c4f:0002 SiGamma Micro Keyboard TRACER Gamma Ivory
Bus 001 Device 001: ID 1d6b:0002 Linux Foundation 2.0 root hub
axio@axio-desktop:~/Downloads$
```

Step6. Running the following command to flash the image.

```
$sudo ./tools/kernel_flash/l4t_initrd_flash.sh --flash-only --massflash 5
```

```
axio@axio-desktop:/media/axio/Backup/ImageINS/SBC87903-A20/ONA/JP5.1.1/20230824_mfi_jetson-orin-nano-8GB-JP5.1.1-SBC87903-V1.0.0/mfi_jetson-orin-nano-8GB-JP5.1.1-SBC87903-V1.0.0$ sudo ./tools/kernel_flash/l4t_initrd_flash.sh --flash-only --massflash 5
[sudo] password for axio:
/media/axio/Backup/ImageINS/SBC87903-A20/ONA/JP5.1.1/20230824_mfi_jetson-orin-nano-8GB-JP5.1.1-SBC87903-V1.0.0/mfi_jetson-orin-nano-8GB-JP5.1.1-SBC87903-V1.0.0/tools/kernel_flash/l4t_initrd_flash_internal.sh --usb-instance 1-8 --device-instance 0 --flash-only --external-device nvme0n1p1 -c "/tools/kernel_flash/flash_l4t_external.xml" --network usb0 p3509-a02+p3767-0000 internal
Start flashing device: 1-8, rcm instance: 0, PID: 27732
Log will be saved to Linux_for_Tegra/initrdlog/flash_1-8_0_20230825-115333.log
Ongoing processes: 27732
Ongoing processes: 27732
Ongoing processes: 27732
Ongoing processes: 27732
Ongoing processes: 27732
```

Step7. The flashing procedure takes approximately 20 minutes or more. Once finished, and AIE100-ONA will automatically reboot, and please switch the recovery switch(SSW2) to OFF to return to standard mode.

[SUCCESS]:

```
Ongoing processes: 27732
Ongoing processes: 27732
Ongoing processes: 27732
Ongoing processes: 27732
Ongoing processes:
axio@axio-desktop:/media/axio/Backup/ImageINS/SBC87903-A20/ONA/JP5.1.1/20230824_mfi_jetson-orin-nano-8GB-JP5.1.1-SBC87903-V1.0.0/mfi_jetson-orin-nano-8GB-JP5.1.1-SBC87903-V1.0.0$
```

[FAIL]: If the flashing procedure fails, you will see a message "Flash complete (WITH FAILURES)" as shown below. In this case, the AIE100-ONA will not automatically reboot. Please press the reset button and repeat the flashing procedure.

```
Ongoing processes: 30731
Ongoing processes: 30731
Ongoing processes:
Flash complete (WITH FAILURES)
axio@axio-desktop:/media/axio/Backup/ImageINS/SBC87903-A20/ONA/JP5.1.1/20230824_mfi_jetson-orin-nano-8GB-JP5.1.1-SBC87903-V1.0.0/mfi_jetson-orin-nano-8GB-JP5.1.1-SBC87903-V1.0.0$
```

## THE DEFAULT LOGIN CREDENTIALS:

Username: nvidia      Password: nvidia

## ⚠CAUTION:



Running `$ sudo apt upgrade` command for NVIDIA JetPack OTA may overwrite the BSP of the AIE series platform, which can cause unexpected results including losing I/O ports. For regular JetPack updates or reflashing, please contact our sales or FAE to get the latest AIE Series JetPack image.

## 4.2 Image Information Inquiry Command

Running `axiomtek.sh` command to inquiry the current image information, image version, L4T version, Linux kernel version, and Ubuntu version.

```
nvidia@nvidia-desktop:~$ axiomtek.sh
BUILD_MODEL=SBC87903-A20 + Jetson-ORIN_NANO
BUILD_VERSION=JetPack-5.1.1_Linux
BSP_BUILD_VERSION=V1.0.0
BSP_BUILD_COMMIT_ID=master_591e2514f
BUILD_DATE=2023/08/23 17:23:11
BUILD_ID=axio
L4T_VERSION=R35-3.1
LINUX_KERNEL_VERSION=5.10.104
UBUNTU_VERSION=Ubuntu 20.04.5 LTS
CUSTOMER_ID=Axiomtek
Libraries:
  CUDA: 11.4.315
  cuDNN: 8.6.0.166
  TensorRT: 8.5.2.2
  VPI: 2.2.7
  Vulkan: 1.3.204
  OpenCV: 4.5.4
  DEEPSTREAM: 6.2.0-1
nvidia@nvidia-desktop:~$
```

### 4.3 JTOP-Third-party Jetson Platform Monitor Tool

JTOP is a third-party system monitoring utility that runs on the terminal and see and control realtime the status of the AIE Series Platform. CPU, RAM, GPU status, power mode management, toolkits version and more.

#### Installation Guide:

Please connect to the internet and enter the following commands in the terminal to install JTOP.

```
$ sudo apt install python3-pip
```

```
$ sudo -H pip3 install -U jetson-stats
```

Once installation is completed, reboot the device and then type the below command in the terminal to launch JTOP:

```
$ sudo jtop
```



**Note:** JTOP may require approximately 200 to 300 MB of storage space.

```

jtop 15W|CPU 13.3%|GPU 0.0%
Model: NVIDIA Orin Nano Developer Kit - Jetpack 5.1.1 [L4T 35.3.1]
1 [ | 3.0%] 729MHz 4 [ | 2.0%] 729MHz
2 [ | 2.0%] 729MHz 5 [ | 7.9%] 729MHz
3 [ | 3.0%] 729MHz 6 [ | 3.0%] 729MHz
Mem [|||||] 1.4G/7.2G FAN [|||||] 63.9% 0RPM
Swp [ | 0k/3.6G] Jetson Clocks: inactive
Enc [204MHz:::] 2.1GHz] 665MHz 0% NV Power[0]: 15W
Uptime: 0 days 0:4:35
GPU [ | 0.0%] 306MHz
Dsk [#####] 17.0G/109G
PID USER GPU TYPE PRI S CPU% MEM [GPU MEM] Command
2413 nvidia I G 20 S 3.8 65.4M 90.3M gnome-shell
2260 nvidia I G 20 S 1.4 10.9M 49.3M Xorg
1475 root I G 20 S 0.4 10.0M 43.4M Xorg
1903 root I G 20 S 1.7 38.5M 22.4M gnome-shell
948 root I G 20 S 0.0 2.6M 0k nvargus-daemon

[HW engines] [Sensor] [Temp] [Power] [Inst] [Avg]
APE: [OFF] CPU 47.59C CPU GPU CV 525mW 650mW
NVENC: [OFF] NVDEC: [OFF] CV0 Offline SOC 1.2W 1.2W
NVJPG: [OFF] NVJPG1: [OFF] CV1 Offline VDD_IN 4.0W 4.1W
SE: 307MHz VIC: [OFF] CV2 Offline GPU 46.62C
SOC0 45.59C
SOC1 47.28C
SOC2 44.88C
tj 47.66C

1ALL 2GPU 3CPU 4MEM 5ENG 6CTRL 7INFO Quit (c) 2023, RB

```