

# USER'S MANUAL

## **AIE110-ONX Series**

Edge AI Developer Kit

User's Manual



[www.axiomtek.com](http://www.axiomtek.com)

## **Disclaimers**

This manual has been carefully checked and believed to contain accurate information. Axiomtek Co., Ltd. assumes no responsibility for any infringements of patents or any third party's rights, or any liability arising from such uses.

Axiomtek does not warrant or assume any legal liability or responsibility for the accuracy, completeness or usefulness of any information in this document. Axiomtek does not make any commitment to update any information in this manual.

Axiomtek reserves the right to change or revise this document and/or product at any time without notice.

No part of this document may be reproduced, stored in a retrieval system, or transmitted in any forms or by any means, electronic, mechanical, photocopying, recording, among others, without prior written permissions of Axiomtek Co., Ltd.

## **CAUTION**

If you replace wrong batteries, it causes the danger of explosion. It is recommended by the manufacturer that you follow the manufacturer's instructions to only replace the same or equivalent type of battery, and dispose of used ones.

**©Copyright 2023 Axiomtek Co., Ltd.**

**All Rights Reserved**

**September 2023, Version A1**

**Printed in Taiwan**

## ESD Precautions

Computer boards have integrated circuits sensitive to static electricity. To prevent chipsets from electrostatic discharge damage, please take care of the following jobs with precautions:

- Do not remove boards or integrated circuits from their anti-static packaging until you are ready to install them.
- Before holding the board or integrated circuit, touch an unpainted portion of the system unit chassis for a few seconds. It discharges static electricity from your body.
- Wear a wrist-grounding strap, available from most electronic component stores, when handling boards and components.

## Trademarks Acknowledgments

Axiomtek is a trademark of Axiomtek Co., Ltd.

IBM, PC/AT, PS/2, VGA are trademarks of International Business Machines Corporation.

Intel® and Pentium® are registered trademarks of Intel Corporation.

NVIDIA® and Jetson are registered trademarks of NVIDIA Corporation.

MS-DOS, Microsoft C and QuickBasic are trademarks of Microsoft Corporation.

Windows 10, Linux and other brand names and trademarks are the properties and registered brands of their respective owners.

# Table of Contents

---

Disclaimers.....	ii
ESD Precautions .....	iii
<b>SECTION 1 INTRODUCTION.....</b>	<b>1</b>
1.1    General Description .....	2
1.2    Developer Kit Specifications.....	3
1.2.1    Product Specification .....	3
1.2.2    I/O System .....	3
1.2.3    System Specification.....	4
1.3    Dimensions .....	5
1.3.1    Developer Kit Dimensions .....	5
1.3.2    Assembly Drawing.....	6
1.4    Packing List.....	7
1.5    Model List .....	7
<b>SECTION 2 BOARD AND PIN ASSIGNMENTS .....</b>	<b>9</b>
2.1    Board Dimensions and Fixing Holes .....	9
2.2    Board Layout.....	10
2.3    Connectors and Switches .....	12
2.3.1    Digital I/O Header (CN2) .....	13
2.3.2    HDMI Connector (CN4) .....	13
2.3.3    USB2.0 & USB3.1 Gen2 Connector (CN5) .....	14
2.3.4    DC Power Jack w/ Screw (CN6).....	14
2.3.5    5V Fan Connector (CN7) .....	14
2.3.6    PCI-Express Mini Card Connector (SCN1) .....	15
2.3.7    M.2 2280 Key M PCIe x4 SSD slot (SCN2) .....	16
2.3.8    SIM Card Slot (SCN3) .....	17
2.3.9    Micro USB 2.0 Connector (SCN4).....	17
2.3.10    Ethernet Ports (LAN1, LAN2) .....	18
2.3.11    Power Button & Reset Button (SW1).....	19
2.3.12    AT/ATX Switch (SSW1) .....	19
2.3.13    Recovery Mode Switch (SSW2).....	19
2.3.14    Debug Port Header (JP1) .....	20
2.3.15    Reserved Connector: Power Button & Recovery mode (JP2) .....	20
2.3.16    I <sup>2</sup> C Connector (JP3).....	20
2.3.17    CMOS Battery Interface (BAT1) .....	21
2.3.18    Power and Storage LED Indicator (LED1).....	21
2.4    Cables .....	22
2.4.1    Digital I/O Cable .....	22
<b>SECTION 3 JETPACK BSP FLASH METHOD.....</b>	<b>23</b>
3.1    JETPACK FLASH METHOD .....	23
3.2    Image Information Inquiry Command.....	26
3.3    JTOP-Third-party Jetson Platform Monitor Tool.....	27
<b>APPENDIX A WATCHDOG TIMER .....</b>	<b>29</b>
A.1    Sample Program .....	29
A.2    wdt.c .....	30
A.3    watchdog.h.....	31
<b>APPENDIX B PROGRAMMABLE DIGITAL I/O.....</b>	<b>33</b>
B.1    Default Setting & Command Format.....	33

**B.2 Sample Program ..... 34**  
**B.3 Register Table ..... 34**

**This page is intentionally left blank.**

## SECTION 1 INTRODUCTION

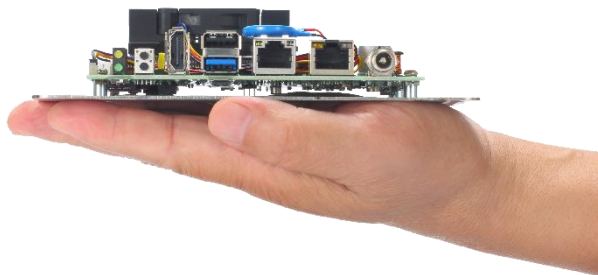
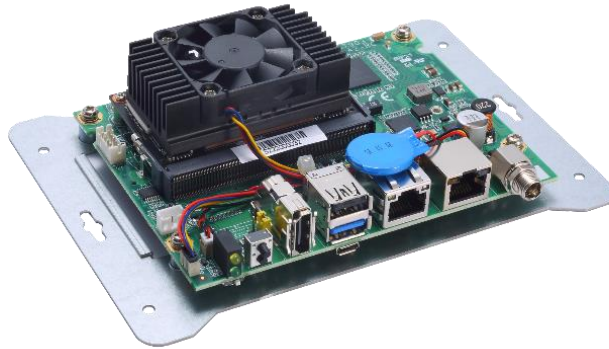

This chapter contains general information and detailed specifications of the AIE110-ONX. The Chapter 1 includes the following sections:

- General Description
- Developer kit Specifications
- Dimensions
- I/O Outlets
- Packing List
- Model List

## 1.1 General Description

The AIE110-ONX is a palm-sized developer kit with NVIDIA® Jetson Orin™ NX Series supercomputer-on-a-module that delivers outstanding AI performance, excellent I/O flexibility, varied peripherals, and accommodation for board support packages (BSP).

It enables users to easily convert the developer kit to an edge system using Axiomtek industrial design services.

This developer kit is equipped with one 8 GB or 16GB 128-bit LPDDR5 102.4GB/s, and a built-in watchdog timer. It also features one GbE, one GbE PoE, one USB 3.2 Gen2, one USB 2.0, one HDMI2.1, and one mini PCI-Express slot with USB and PCIe signal. Additionally, it offers users one M.2 Key M NVMe slot that provides high-performance storage for makers to process the massive data and the edge AI application development.

There are more interfaces available, such as 8CH DIO, debug port, recovery switch, Micro USB for image flash, and more.

- **Features**

1. NVIDIA® Jetson Orin™ NX (Up to 100 TOPS)
2. 2 USB, 1 8CH DIO, 1 GbE and 1 GbE PoE (15W)
3. 1 M.2 Key M NVMe SSD slot for massive data processing
4. 1 Mini PCI-Express slot & SIM slot for Wi-Fi / Bluetooth / LTE / GPS
5. 12VDC Power input (DC Jack Screw Type)

- **JetPack Supported**

The AIE110-ONX supports JetPack 5.1.1 or later. NVIDIA JetPack SDK is the most comprehensive solution for building AI applications.

JetPack supports Jetson AGX Orin™, Jetson Orin™ NX, Jetson Orin™ Nano, Jetson AGX Xavier™, Jetson Xavier™ NX, Jetson™ TX2 NX, Jetson™ Nano and Jetson TX2 series. It bundles all the Jetson platform software, including TensorRT, cuDNN, CUDA Toolkit, VisionWorks, GStreamer, and OpenCV, all built on top of L4T with LTS Linux kernel.

- **OS Supported**

The AIE110-ONX supports Linux Ubuntu 20.04 or later.

- **High-performance NVMe SSD Storage Supported**

For storage device, the AIE110-ONX supports one M.2 2280 Key M with PCI-Express 2.0 x4 interface.



## 1.2 Developer Kit Specifications

### 1.2.1 Product Specification

- **NVIDIA Jetson SKU**
  - NVIDIA® Jetson Orin™ NX Series 8GB (70 TOPS)
  - NVIDIA® Jetson Orin™ NX Series 16GB (100 TOPS)
- **CPU**
  - 8GB: 6-core NVIDIA Arm® Cortex A78AE v8.2 64-bit CPU 1.5MB L2 + 4MB L3
  - 16GB: 8-core NVIDIA Arm® Cortex A78AE v8.2 64-bit CPU 2MB L2 + 4MB L3
- **GPU**
  - 1024-core NVIDIA Ampere architecture GPU with 32 Tensor Cores
- **Storage**
  - One M.2 2280 M Key with PCI-Express 2.0 x4 NVMe SSD slot

*\*Orin NX no longer has built-in eMMC and only supports SSD for the bootable device.*
- **System Memory**
  - 8GB: 8GB 128-bit LPDDR5 102.4GB/s
  - 16GB: 16GB 128-bit LPDDR5 102.4GB/s
- **WLAN & WWAN**
  - One PCI Express Mini Card modules slot to support Wi-Fi or 3G/4G/LTE modules

### 1.2.2 I/O System

- One HDMI 2.1 for display (Resolution: up to 7680x4320 @30Hz)
- One RJ-45 connector for 10/100/1000 Base-T Ethernet port
- One RJ-45 connector for 10/100/1000 Base-T PoE (IEEE 802.3af; PSE), max. up to 15.4 Watts



**Note:** AIE110 is a power supply device. Two PSE devices should not be connected together, which may cause the risk of power conflict. Correctly connect PD Device or switch without PoE. If you need PoE switch, please find the switch with uplink port.

- One USB 2.0 and one USB 3.2 Gen2 connectors
- Front-access design for ease of updating NVIDIA Jetpack
  - One Micro USB connector for image flash only
  - One Recovery switch
- One M.2 2280 Key M with PCI-Express2.0 x4 SSD slot for massive data processing
 

*\*Orin NX no longer has built-in eMMC and only supports SSD for the bootable device.*
- One full-size PCI Express Mini Card slot (USB + PCI Express signal)
- One Power button and one Reset button

- **Two LED Indicators (System Power, M.2 Storage)**
- **One 12 VDC Power Jack connector**

### **1.2.3 System Specification**

- **Watchdog Timer**
  - Built-in NVIDIA® Jetson Orin™ NX Series
- **Power Supply**
  - Input : 12 VDC
- **Thermal Solution**
  - Active heatsink
- **Operation Temperature**
  - -10°C ~ +60°C (-14°F ~ +140°F)
- **Humidity**
  - 10% ~ 95% (non-condensing)
- **Weight**
  - 0.3 kg (0.66 lb) without package
  - 0.9 kg (1.98 lb) with package
- **Dimensions**
  - 165 mm (6.49") (W) x 117 mm (4.60") (D) x 37.7 mm (1.48") (H)



**Note:** All specifications and images are subject to change without notice.

## 1.3 Dimensions

The following diagrams show the dimensions and outlines of the AIE110-ONX.

### 1.3.1 Developer Kit Dimensions

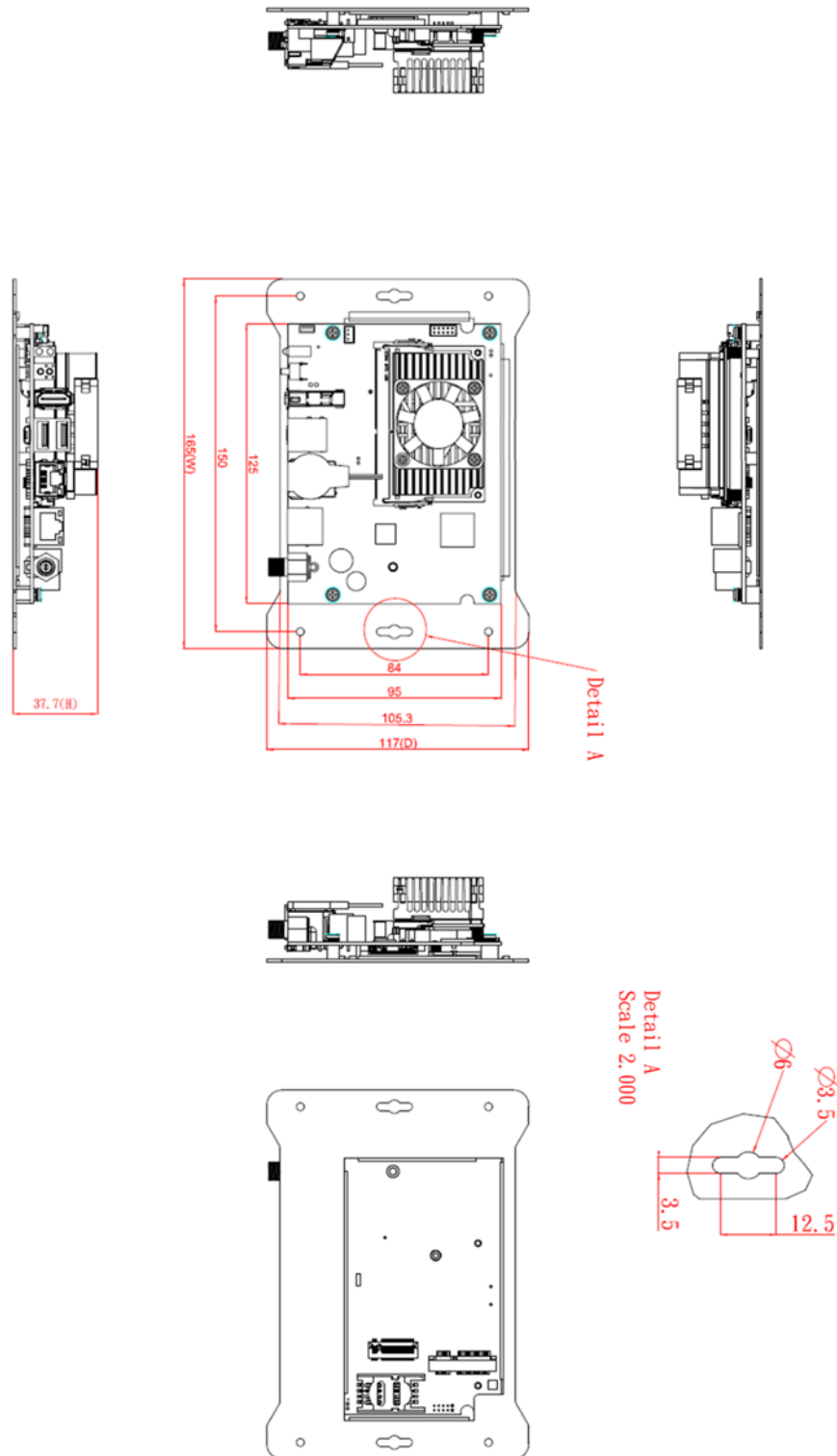

### 1.3.2 Assembly Drawing

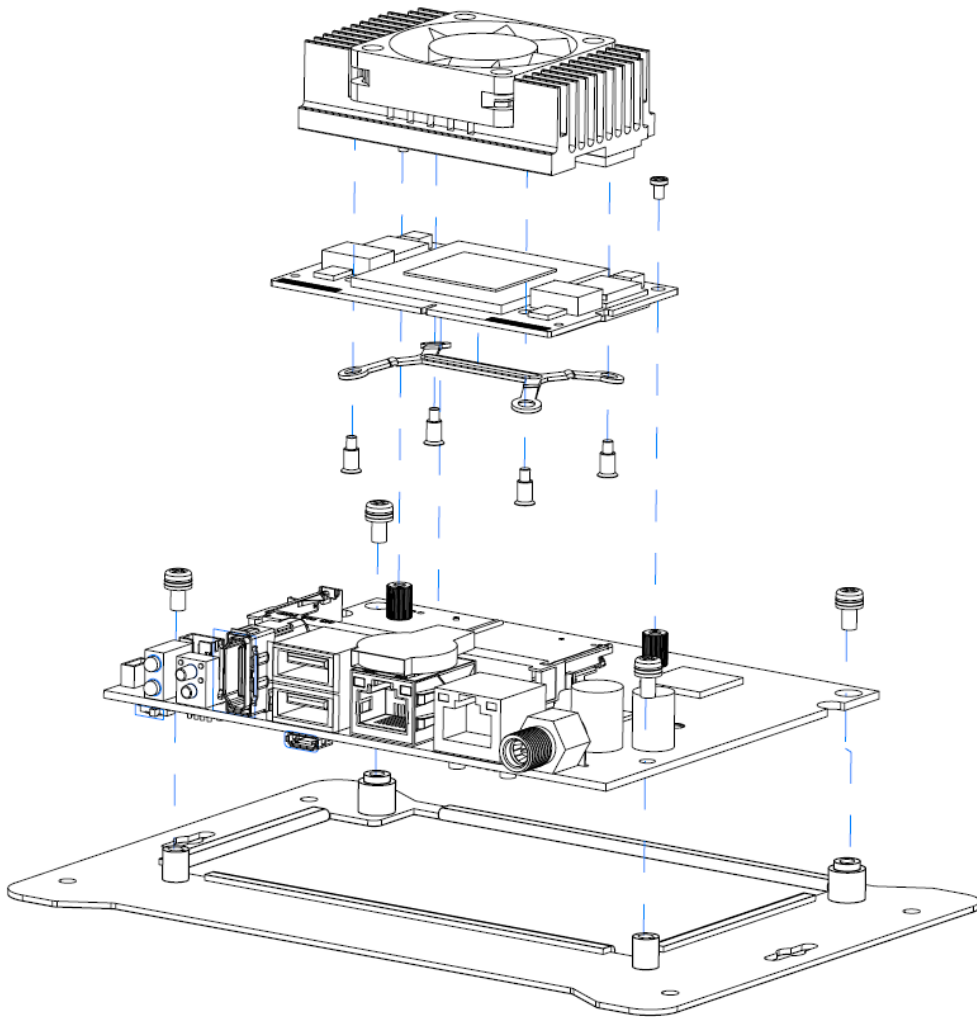

## 1.4 Packing List

The package bundled with your AIE110-ONX should contain the following items:

- **AIE110-ONX Developer Kit Unit x 1**
- **Digital I/O Cable x 1**
- **(Optional) Power Adapter**
- **(Optional) Power Cord**
- **(Optional) M.2 Key M NVMe SSD**
- **(Optional) Wi-Fi or LTE module kit**

※Regarding the latest product manual, please download them from Axiomtek official website.

## 1.5 Model List

<b>AIE110-ONX-8GB</b>	Edge AI Developer Kit with NVIDIA® Jetson Orin™ NX 8GB, 1 HDMI, 1 GbE LAN, 1 GbE PoE and 2 USB
<b>AIE110-ONX-16GB</b>	Edge AI Developer Kit with NVIDIA® Jetson Orin™ NX 16GB, 1 HDMI, 1 GbE LAN, 1 GbE PoE and 2 USB

If you cannot find this package or any items are missing, please contact Axiomtek distributors immediately.

**This page is intentionally left blank.**

## SECTION 2 BOARD AND PIN ASSIGNMENTS

Proper jumper settings configure the **AIE110-ONX** to meet your application purpose. We are here with listing a summary table of all jumpers and default settings for onboard devices, respectively.

### 2.1 Board Dimensions and Fixing Holes

Top View

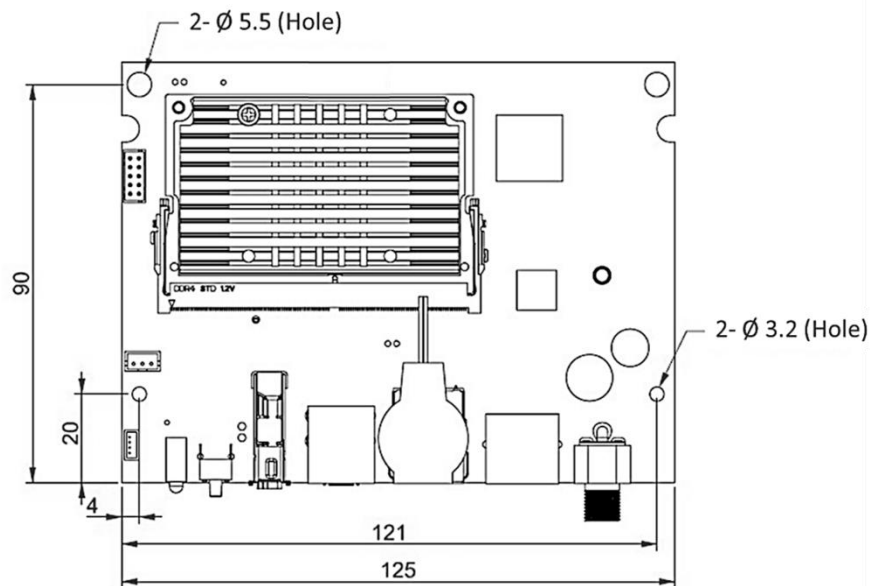

Bottom View

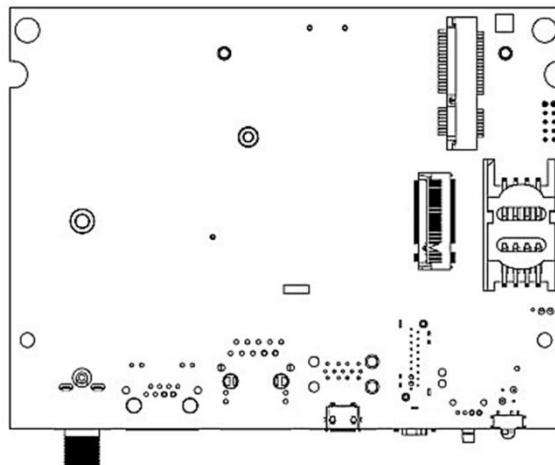

## 2.2 Board Layout

Top View

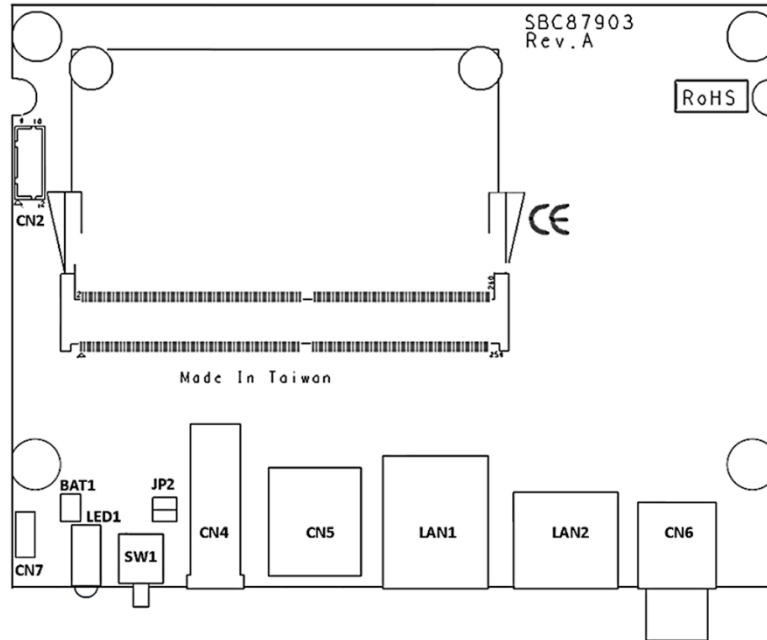

Bottom View

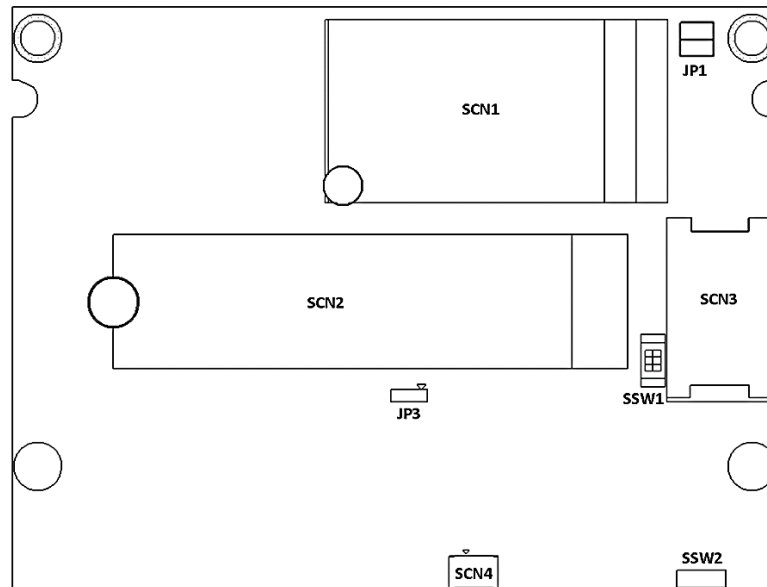



**Side View**

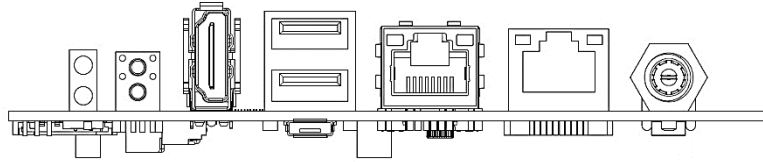

**Note:** We strongly recommended that you should not modify any unmentioned jumper setting without Axiomtek FAE's instruction. Any modification without instruction might cause damage to the system.

## 2.3 Connectors and Switches

Connectors connect the board with other parts of the system. Loose or improper connection might cause problems. Make sure all connectors are properly and firmly connected. Here is a summary table shows you all connectors and button on the **AIE110-ONX** Series.

External Connectors / Buttons	PCB Location	Section
Digital I/O Connector	CN2	2.3.1
HDMI Connector	CN4	2.3.2
USB2.0 & USB3.1 Gen2 Connector	CN5	2.3.3
DC-in Connector	CN6	2.3.4
5V Fan Connector	CN7	2.3.5
PCI-Express Mini Card slot	SCN1	2.3.6
M.2 2280 Key M PCIe x4 SSD slot	SCN2	2.3.7
SIM Card Slot	SCN3	2.3.8
Micro USB 2.0 Connector (For Jetpack flash)	SCN4	2.3.9
Ethernet Ports	LAN1	2.3.10
PoE Ports	LAN2	2.3.11
Power Button & Reset Button	SW1	2.3.11
AT/ATX Switch	SSW1	2.3.12
Recovery Mode Switch (For Jetpack flash)	SSW2	2.3.13
Debug Port Connector	JP1	2.3.14
Reserved Connector: Power Button & Recovery mode	JP2	2.3.15
I <sup>2</sup> C Connector	JP3	2.3.16
CMOS Battery Interface	BAT1	2.3.17
Power and Storage LED Indicator	LED1	2.3.18

### 2.3.1 Digital I/O Header (CN2)

The CN12 is a 2 x 5-pin header for 8-Channel digital I/O interface.

The digital I/O is controlled via software programming.

Pin	Signal	Pin	Signal
1	DIO1	2	DIO2
3	DIO3	4	DIO4
5	DIO5	6	DIO6
7	DIO7	8	DIO8
9	+5V_SBY	10	GND

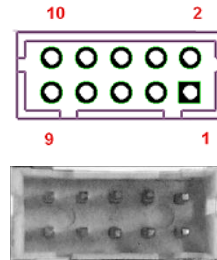

### 2.3.2 HDMI Connector (CN4)

The HDMI (High-Definition Multimedia Interface) is a compact digital interface which is capable of transmitting high-definition video and high-resolution audio over a single cable.

Pin	Signal	Pin	Signal
1	HDMI1_DATA2+	2	GND
3	HDMI1_DATA2-	4	HDMI1_DATA1+
5	GND	6	HDMI1_DATA1-
7	HDMI1_DATA0+	8	GND
9	HDMI1_DATA0-	10	HDMI1_CLK+
11	GND	12	HDMI1_CLK-
13	HDMI_CEC	14	NC
15	HDMI1_SCL	16	HDMI1_SDA
17	GND	18	+5V
19	HDMI_HTPLG		

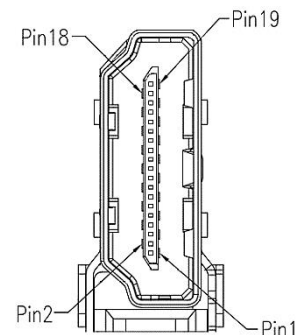

### 2.3.3 USB2.0 & USB3.1 Gen2 Connector (CN5)

The Universal Serial Bus connectors are compliant with USB 2.0 (480Mbps) and USB 3.1 Gen2 (10Gbps), and ideally for installing USB peripherals such as keyboard, mouse, scanner, etc.

Pin	Signal	Pin	Signal
1	5V_USB1	7	GND
2	USB1_D-	8	USB_SS1_TX-
3	USB1_D+	9	USB_SS1_TX+
4	GND	10	5V_USB2
5	USB_SS1_RX-	11	USB2_D-
6	USB_SS1_RX+	12	USB2_D+
13	GND		

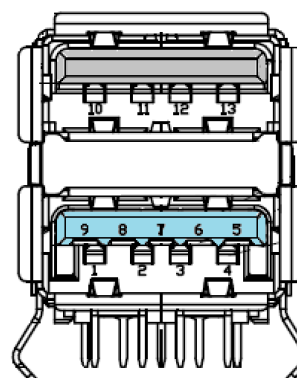

### 2.3.4 DC Power Jack w/ Screw (CN6)

The CN6 is a DC jack with screw. Firmly insert at least 60W adapter into this connector. Loose connection may cause system instability and make sure all components/devices are properly installed before connecting.

Pin	Signal
1	12V
2	GND

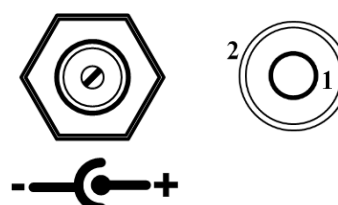

### 2.3.5 5V Fan Connector (CN7)

This is a 4-pin connector for smart fan interface.

Pin	Signal
1	GND
2	+5V
3	TACH
4	PWM (5V)

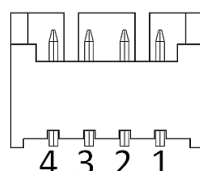

### 2.3.6 PCI-Express Mini Card Connector (SCN1)

The AIE110-ONX supports a full-size PCI-Express Mini Card slots. SCN1 is applying to either PCI-Express or USB 2.0 signal, and complies with PCI-Express Mini Card Spec. V1.2.

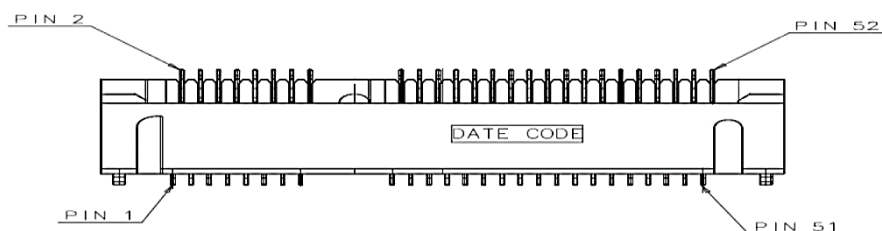

Pin	Signal	Pin	Signal	Pin	Signal	Pin	Signal
1	WAKE#	2	+3.3V	3	NC	4	GND
5	NC	6	+1.5V	7	CLKREQ#	8	UIM_PWR
9	GND	10	UIM_DATA	11	REFCLK-	12	UIM_CLK
13	REFCLK+	14	UIM_RESET	15	GND	16	UIM_VPP
17	NC	18	GND	19	NC	20	WLAN_DISABLE# / Orin™ NX's GPIO05
21	GND	22	NC	23	PEX2_RX-	24	+3.3V
25	PEX2_RX+	26	GND	27	GND	28	+1.5V
29	GND	30	Orin™ NX's I2C2_SCL	31	PEX2_TX-	32	Orin™ NX's I2C2_SDA
33	PEX2_TX+	34	GND	35	GND	36	USB2.0_D-
37	GND	38	USB2.0_D+	39	+3.3V	40	GND
41	+3.3V	42	LED_WWAN#	43	GND	44	NC
45	NC	46	NC	47	NC	48	+1.5V
49	NC	50	GND	51	NC	52	+3.3V

### 2.3.7 M.2 2280 Key M PCIe x4 SSD slot (SCN2)

The AIE110-ONX comes with one M.2 2280 Key M PCIe x4 NVMe SSD slot for storage.

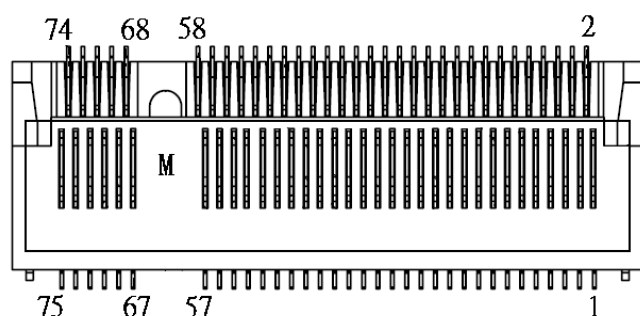

Pin	Signal	Pin	Signal	Pin	Signal	Pin	Signal
1	GND	2	+3.3V	3	GND	4	+3.3V
5	PEX3_RX-	6	NC	7	PEX3_RX+	8	NC
9	GND	10	LED_1#	11	PEX3_TX-	12	+3.3V
13	PEX3_TX+	14	+3.3V	15	GND	16	+3.3V
17	PEX2_RX-	18	+3.3V	19	PEX2_RX+	20	NC
21	GND	22	NC	23	PEX2_TX-	24	NC
25	PEX2_TX+	26	NC	27	GND	28	NC
29	PEX1_RX-	30	NC	31	PEX1_RX+	32	NC
33	GND	34	NC	35	PEX1_TX-	36	NC
37	PEX1_TX+	38	M.2_DEVSLP	39	GND	40	NC
41	PEX0_RX-	42	NC	43	PEX0_RX+	44	NC
45	GND	46	NC	47	PEX0_TX-	48	NC
49	PEX0_TX+	50	PERST#	51	GND	52	CLKREQ#
53	PEX0_REFCLKn	54	PEWAKE#	55	PEX0_REFCLKp	56	NC
57	GND	58	NC	59	CONNECTOR Key M	60	CONNECTOR Key M
61	CONNECTOR Key M	62	CONNECTOR Key M	63	CONNECTOR Key M	64	CONNECTOR Key M
65	CONNECTOR Key M	66	CONNECTOR Key M	67	NC	68	NC
69	NC	70	+3.3V	71	GND	72	+3.3V
73	GND	74	+3.3V	75	GND		

### 2.3.8 SIM Card Slot (SCN3)

AIE110-ONX comes with SIM Card Slot (SCN3) for inserting SIM Card. In order to work properly, the SIM Card must be used together with 3G/LTE module which would be inserted to PCI-Express Mini Card Connector (SCN1). It is mainly used for 3G/LTE wireless network application.

Pin	Signal	Pin	Signal
1	UIM PWR	5	GND
2	UIM RST	6	UIM VPP
3	UIM CLK	7	UIM DATA
4	NC	8	NC

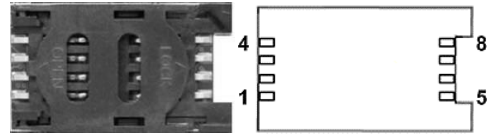

### 2.3.9 Micro USB 2.0 Connector (SCN4)

The SCN4 is specifically designed for image flashing only. To flash Jetpack, please switch SSW2 to ON before booting up the system, which would force the system to recovery mode.

Pin	Signal
1	+5V
2	USB0 DN
3	USB0 DP
4	GND
5	GND

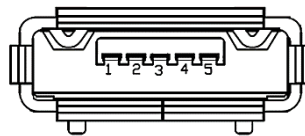

### 2.3.10 Ethernet Ports (LAN1, LAN2)

The AIE110-ONX comes with two RJ-45 connectors: LAN1 (NVIDIA® Jetson Orin™ NX) and LAN2 (Intel® I210-IT). LAN1 is a GbE port, but LAN2 is the GbE PoE port (non-isolated), which is compliant IEEE 802.3af class 3, and the total power budget is 15Watts maximum.

LAN1		LAN2 (PoE)	
Pin	Signal	Pin	Signal
1	Tx+(Data transmission positive)	1	Tx+ (Data transmission positive)
2	Tx-(Data transmission negative)	2	Tx- (Data transmission negative)
3	Rx+(Data reception positive)	3	Rx+(Data reception positive)
4	RJ-1(For 1000 base T-Only)	4	RJ-1(For 1000 base T-Only)
5	RJ-1(For 1000 base T-Only)	5	RJ-1(For 1000 base T-Only)
6	Rx- (Data reception negative)	6	Rx- (Data reception negative)
7	RJ-1(For 1000 base T-Only)	7	RJ-1(For 1000 base T-Only)
8	RJ-1(For 1000 base T-Only)	8	RJ-1(For 1000 base T-Only)
A	Active LED	A	Active LED
B	Speed LED (1000M)	B	Speed LED (1000M / 100M)

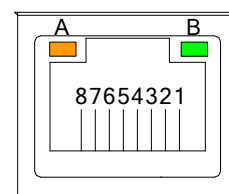



### 2.3.11 Power Button & Reset Button (SW1)

Power button can allow users to either turn on the AIE110-ONX or forcibly shut down the system, and the reset button can allow users to reset AIE110-ONX during system abnormal situation.

Pin	Signal
1	GND
2	GND
3	RST_BTN
4	PWR_BTN
5	GND
6	GND

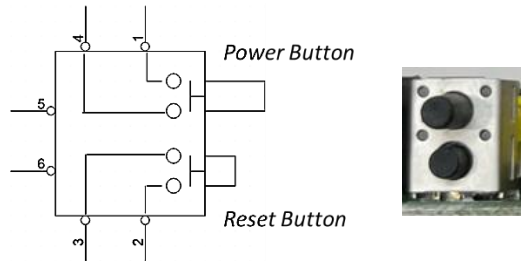

### 2.3.12 AT/ATX Switch (SSW1)

If you turn OFF the Pin1 (AT mode) of SSW1, the system will be automatically power on without pressing soft power button during power input; we can use this switch to achieve auto power on demand.

Pin	Description	ON (Default)	OFF
1	AT / ATX Mode	ATX	AT
2	NC	NC	NC

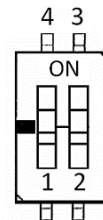

### 2.3.13 Recovery Mode Switch (SSW2)

It will make NVIDIA® Jetson Orin™ NX force recovery mode when switching SSW2 to ON before booting up the system.

Pin	Signal
ON	Recovery Mode
OFF	Normal

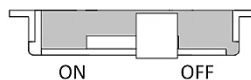

### 2.3.14 Debug Port Header (JP1)

The JP1 is the serial debug port (UART Port0) for debugging purposes at software development.

Pin	Signal
1	+5V
2	UART2_TXD_3.3V
3	GND
4	UART2_RXD_3.3V

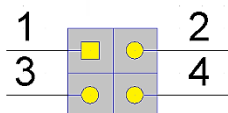

### 2.3.15 Reserved Connector: Power Button & Recovery mode (JP2)

JP2 is a reserved connector for entering recovery mode (1-2) and power button (3-4). It supports the same function as SSW2 and SSW1(Power button only).

Pin	Signal
1	Recovery_N
2	GND
3	PWR_BTN
4	GND

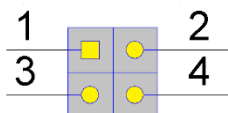

### 2.3.16 I<sup>2</sup>C Connector (JP3)

JP3 is connect to I<sup>2</sup>C port 0 of the NVIDIA® Jetson Orin™ NX, and it has pull up 2.2k ohm to 3.3V on carrier board.

Pin	Signal
1	I <sup>2</sup> C0_SDA (3.3V)
2	I <sup>2</sup> C0_SCL (3.3V)
4	GND

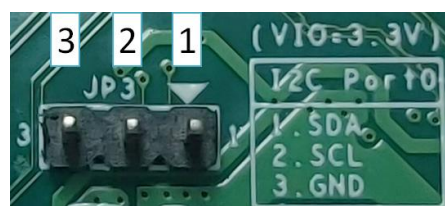

### 2.3.17 CMOS Battery Interface (BAT1)

This connector is for CMOS battery interface.

Pin	Signal
1	+VBAT
2	GND

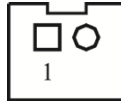

### 2.3.18 Power and Storage LED Indicator (LED1)

The Yellow LED is linked to Solid-state Drive (SSD) activity signal. LED flashes every time SSD is accessed. The power LED (Green) lights up and will remain steady while the system is powered on.

LED Color	Description
Yellow	Solid-state drive activity
Green	Power on/off



## 2.4 Cables

### 2.4.1 Digital I/O Cable

This cable is for 8-Channel digital I/O programming, please connect the digital I/O cable to Digital I/O Header (CN2).

Pin	Signal	Pin	Signal
1	DIO1	6	DIO6
2	DIO3	7	DIO4
3	DIO5	8	DIO2
4	DIO7	9	GND
5	DIO8		

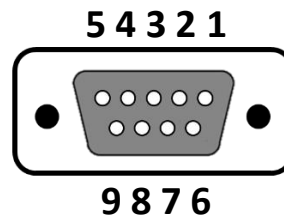

## SECTION 3

# JETPACK BSP FLASH METHOD

This chapter provides users with a detailed description of how to flash NVIDIA Jetpack BSP for AIE110-ONX, the user could follow the below instruction to install or reinstall Jetpack BSP by themselves.

### 3.1 JETPACK FLASH METHOD

Please use the following instructions to flash the JetPack to the AIE110-ONX.

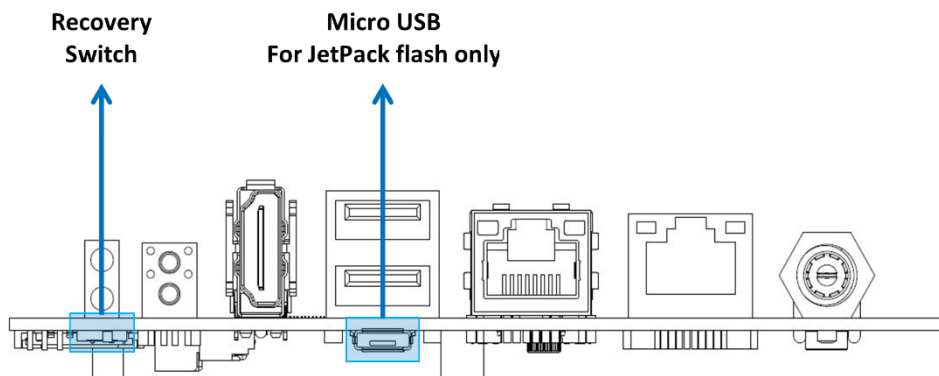

Please contact our sales or FAE for the latest Jetpack SDK, and prepare a Linux host system running x86\_64 Ubuntu v18.04 or later.

**Note:** If the Linux host system is running x86\_64 Ubuntu v18.04, please follow the instructions below to install Python first.

Step 1. Connect the Linux host system to internet

Step 2. Install Python with the command below:

```
sudo apt-get update
sudo apt-get install python
```

Step1. AIE110-ONX connection as follows:

- ⇒ Connect a USB cable from the Linux host system to the Micro USB port at AIE110-ONX, and switch the recovery switch to ON. For more details, please refer to [2.2.13 Recovery Mode Switch \(SSW2\)](#).
- ⇒ Connect an HDMI monitor to AIE110-ONX.

Step2. Open the terminal at the host system, and change the path to the image file directory, e.g., "~/Downloads", and check image tarball data integrity with the following commands:

```
$ cd ~/Downloads
$ md5sum -c <image_tarball_file_name>.tbz2.md5sum
```

**Command Example:**

```
$ md5sum -c mfi_jetson-orin-nx-JP5.1.1-SBC87903-V1.0.0.tbz2.md5sum
```

```
axio@axio-desktop:~/Downloads$ md5sum -c mfi_jetson-orin-nx-JP5.1.1-SBC87903-V1.0.0.tbz2.md5sum
mfi_jetson-orin-nx-JP5.1.1-SBC87903-V1.0.0.tbz2: OK
axio@axio-desktop:~/Downloads$ █
```

Step3. If the check result returns OK, untar the image file with the command below:

```
$ tar jxvf <image_tarball_file_name>.tbz2
```



**Command Example:**

```
$ tar jxvf mfi_jetson-orin-nx-JP5.1.1-SBC87903-V1.0.0.tbz2
```

```
axio@axio-desktop:~/Downloads$ tar jxvf mfi_jetson-orin-nx-JP5.1.1-SBC87903-V1.0.0.tbz2 █
```

Step4. Change the directory to the image package folder with the command below:

```
$ cd <image_file_name>
```



**Command Example:**

```
$ cd mfi_jetson-orin-nx-JP5.1.1-SBC87903-V1.0.0
```

```
axio@axio-desktop:~/Downloads$ cd mfi_jetson-orin-nx-JP5.1.1-SBC87903-V1.0.0
axio@axio-desktop:~/Downloads/mfi_jetson-orin-nx-JP5.1.1-SBC87903-V1.0.0$ █
```

Step5. Make sure the recovery switch(SSW2) has been switched to ON, and run the command lsusb, then the command line "0955:7323 Nvidia Corp." should be listed.

```
$ lsusb
```

```
axio@axio-desktop:~/Downloads$ lsusb
Bus 002 Device 001: ID 1d6b:0003 Linux Foundation 3.0 root hub
Bus 001 Device 004: ID 1c4f:0002 SiGma Micro Keyboard TRACER Gamma Ivory
Bus 001 Device 003: ID 067b:2303 Prolific Technology, Inc. PL2303 Serial Port
Bus 001 Device 002: ID 067b:2303 Prolific Technology, Inc. PL2303 Serial Port
Bus 001 Device 052: ID 0955:7323 NVidia Corp.
Bus 001 Device 006: ID 05e3:0608 Genesys Logic, Inc. Hub
Bus 001 Device 005: ID 045e:00cb Microsoft Corp. Basic Optical Mouse v2.0
Bus 001 Device 001: ID 1d6b:0002 Linux Foundation 2.0 root hub
axio@axio-desktop:~/Downloads$ █
```

Step6. Running the following command to flash the image.

```
$sudo ./tools/kernel_flash/l4t_initrd_flash.sh --flash-only --massflash 5
```

```
axio@axio-desktop:~/Downloads/mfi_jetson-orin-nx-JP5.1.1-SBC87903-V1.0.0$ sudo ./tools/kernel_flash/l4t_initrd_flash.sh --flash-only --massflash 5
[sudo] password for axio:
/home/axio/Downloads/mfi_jetson-orin-nx-JP5.1.1-SBC87903-V1.0.0/tools/kernel_flash/l4t_initrd_flash_internal.sh --usb-instance 1-3 --device-instance 0 --flash-only --external-device nvme0n1p1 -c "tools/kernel_flash/flash_l4t_external.xml" --network usb0 jetson-orin-nano-devkit internal
Start flashing device: 1-3, rcm instance: 0, PID: 3165
Log will be saved to Linux_for_Tegra/initrdlog/flash_1-3_0_20230428-135212.log
Ongoing processes: 3165
Ongoing processes: 3165
Ongoing processes: 3165
Ongoing processes: 3165
```

Step7. The flashing procedure takes approximately 20 minutes or more. Once finished, and AIE110-ONX will automatically reboot, and please remove the Micro USB cable and switch the recovery switch(SSW2) to OFF to return to standard mode.

#### [SUCCESS]:

```
Ongoing processes: 3165
Ongoing processes: 3165
Ongoing processes: 3165
Ongoing processes:
axio@axio-desktop:~/Downloads/mfi_jetson-orin-nx-JP5.1.1-SBC87903-V1.0.0$
```

#### [FAIL]:

If the flashing procedure fails, you will see a message "Flash complete (WITH FAILURES)" as shown below. In this case, the AIE110-ONX will not automatically reboot. Please press the reset button and repeat the flashing procedure.

```
Ongoing processes: 16446
Ongoing processes: 16446
Ongoing processes:
Flash complete (WITH FAILURES)
axio@axio-desktop:~/Test/mfi_jetson-orin-nx-JP5.1.1-SBC87903-V1.0.0$
```

#### THE DEFAULT LOGIN CREDENTIALS:

Username: nvidia      Password: nvidia

#### ⚠CAUTION:



Running **\$ sudo apt upgrade** command for NVIDIA JetPack OTA may overwrite the BSP of the AIE series platform, which can cause unexpected results including losing I/O ports. For regular JetPack updates or reflashing, please contact our sales or FAE to get the latest AIE Series JetPack image.

## 3.2 Image Information Inquiry Command

Running `axiomtek.sh` command to inquiry the current image information, image version, L4T version, Linux kernel version, and Ubuntu version.

```
nvidia@nvidia-desktop:~$ axiomtek.sh
BUILD_MODEL=SBC87903-A20 + Jetson-ORIN_NX
BUILD_VERSION=JetPack-5.1_Linux
BSP_BUILD_VERSION=V1.0.0
BSP_BUILD_COMMIT_ID=master_76fafb8c8
BUILD_DATE=2023/02/23 11:28:47
BUILD_ID=axio
L4T_VERSION=R35-2.1
LINUX_KERNEL_VERSION=5.10.104
UBUNTU_VERSION=Ubuntu 20.04.5 LTS
nvidia@nvidia-desktop:~$ █
```



### 3.3 JTOP-Third-party Jetson Platform Monitor Tool

JTOP is a third-party system monitoring utility that runs on the terminal and see and control realtime the status of the AIE Series Platform. CPU, RAM, GPU status, power mode management, toolkits version and more.

#### Installation Guide:

Please connect to the internet and enter the following commands in the terminal to install JTOP.

```
$ sudo apt install python3-pip
```

```
$ sudo -H pip3 install -U jetson-stats
```

Once installation is completed, reboot the device and then type the below command in the terminal to launch JTOP:

```
$ sudo jtop
```

 **Note:** JTOP may require approximately 200 to 300 MB of storage space.

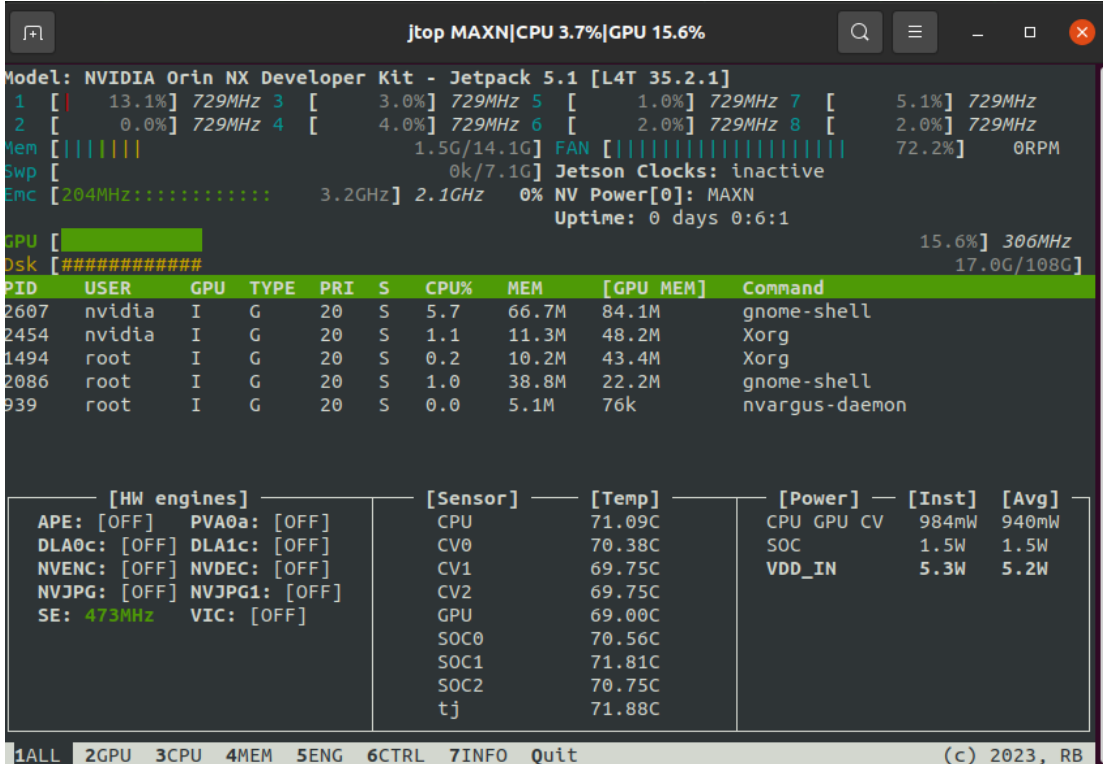

```

jtop MAXN|CPU 3.7%|GPU 15.6%
Model: NVIDIA Orin NX Developer Kit - Jetpack 5.1 [L4T 35.2.1]
1 [ 13.1%] 729MHz 3 [ 3.0%] 729MHz 5 [ 1.0%] 729MHz 7 [ 5.1%] 729MHz
2 [ 0.0%] 729MHz 4 [ 4.0%] 729MHz 6 [ 2.0%] 729MHz 8 [ 2.0%] 729MHz
Mem [|||||] 1.5G/14.1G FAN [|||||||||||||||||] 72.2% 0RPM
Swp [ 0k/7.1G] Jetson Clocks: inactive
Emc [204MHz::: 3.2GHz] 2.1GHz 0% NV Power[0]: MAXN
Uptime: 0 days 0:6:1
GPU [ ] 15.6% 306MHz
Dsk [#####] 17.0G/108G
PID USER GPU TYPE PRI S CPU% MEM [GPU MEM] Command
2607 nvidia I G 20 S 5.7 66.7M 84.1M gnome-shell
2454 nvidia I G 20 S 1.1 11.3M 48.2M Xorg
1494 root I G 20 S 0.2 10.2M 43.4M Xorg
2086 root I G 20 S 1.0 38.8M 22.2M gnome-shell
939 root I G 20 S 0.0 5.1M 76k nvargus-daemon

[HW engines] [Sensor] [Temp] [Power] [Inst] [Avg]
APE: [OFF] PVA0a: [OFF] CPU 71.09C CPU GPU CV 984mW 940mW
DLA0c: [OFF] DLA1c: [OFF] CV0 70.38C SOC 1.5W 1.5W
NVENC: [OFF] NVDEC: [OFF] CV1 69.75C VDD_IN 5.3W 5.2W
NVJPG: [OFF] NVJPG1: [OFF] CV2 69.75C
SE: 473MHz VIC: [OFF] GPU 69.00C
SOC0 70.56C
SOC1 71.81C
SOC2 70.75C
tj 71.88C

1ALL 2GPU 3CPU 4MEM 5ENG 6CTRL 7INFO Quit (c) 2023, RB

```

**This page is intentionally left blank.**

## APPENDIX A WATCHDOG TIMER

### About Watchdog Timer

Software stability is major issue in most applications. Some embedded systems are not watched by human for 24 hours. It is usually too slow to wait for someone to reboot when computer hangs. The systems need to be able to reset automatically when things go wrong. The watchdog timer gives us solutions in this regard.

The watchdog timer is a counter that triggers a system to reset when it counts down to zero from a preset value. The software starts the counter with an initial value and must reset it periodically. If the counter ever reaches zero, it means the software has crashed, the system will reboot.

### A.1 Sample Program

1. Put “wdt.c” and “watchdog.h” two files into target AIE device.
2. Compile by below command line:

```
# gcc wdt.c -o wdt
```

3. Test: (default: 60 seconds, if there is no timeout value as input parameter)

```
# sudo ./wdt <timeout in seconds>
```

⇒ System will reboot automatically after timeout

```
nvidia@nvidia-desktop:~/Downloads$ cd watchdog_example_code/  
nvidia@nvidia-desktop:~/Downloads/watchdog_example_code$ gcc wdt.c -o wdt  
nvidia@nvidia-desktop:~/Downloads/watchdog_example_code$ sudo ./wdt  
[sudo] password for nvidia:  
Watchdog timeout value: 120  
New watchdog timeout value: 60  
nvidia@nvidia-desktop:~/Downloads/watchdog_example_code$
```

```
nvidia@nvidia-desktop:~/Downloads/watchdog_example_code$ sudo ./wdt 240  
[sudo] password for nvidia:  
Watchdog timeout value: 120  
New watchdog timeout value: 240  
nvidia@nvidia-desktop:~/Downloads/watchdog_example_code$
```

## A.2 wdt.c

```
#include <stdio.h>
#include <stdlib.h>
#include <unistd.h>
#include <fcntl.h>
#include <errno.h>
#include <sys/ioctl.h>
#include <sys/types.h>
#include <sys/stat.h>
#include "watchdog.h"

int main(int argc, char **argv)
{
    int fd, ret;
    int timeout = 0;

    /* open WDT0 device (WDT0 enables itself automatically) */
    fd = open("/dev/watchdog0", O_RDWR);
    if (fd < 0) {
        fprintf(stderr, "Open watchdog device failed!\n");
        return -1;
    }

    /* WDT0 is counting now, check the default timeout value */
    ret = ioctl(fd, WDIOC_GETTIMEOUT, &timeout);
    if (ret) {
        fprintf(stderr, "Get watchdog timeout value failed!\n");
        return -1;
    }
    fprintf(stdout, "Watchdog timeout value: %d\n", timeout);

    /* set new timeout value 60s */
    /* Note the value should be within [5, 1000] */
    if (argc > 1) {
        timeout = atoi(argv[1]);
    } else {
        timeout = 60;
    }
    ret = ioctl(fd, WDIOC_SETTIMEOUT, &timeout);
    if (ret) {
        fprintf(stderr, "Set watchdog timeout value failed!\n");
        return -1;
    }
    fprintf(stdout, "New watchdog timeout value: %d\n", timeout);

    /* Kick WDT0, this should be running periodically */
    ret = ioctl(fd, WDIOC_KEEPALIVE, NULL);
    if (ret) {
        fprintf(stderr, "Kick watchdog failed!\n");
        return -1;
    }
}
```

```

/* close WDT0 device */
close(fd);
if (ret<0) {
    fprintf(stderr, "Failed to close watchdog device.");
    return -1;
}

return 0;
}

```

### A.3 watchdog.h

```

#include <linux/ioctl.h>
#include <linux/types.h>

/*
 * Generic watchdog defines. Derived from..
 *
 * Berkshire PC Watchdog Defines
 * by Ken Hollis
 *
 */

#ifndef _LINUX_WATCHDOG_H
#define _LINUX_WATCHDOG_H

#define WATCHDOG_IOCTL_BASE 'W'

struct watchdog_info {
    __u32 options; /* Options the card/driver supports */
    __u32 firmware_version; /* Firmware version of the card */
    __u8 identity[32]; /* Identity of the board */
};

#define WDIOC_GETSUPPORT _IOR(WATCHDOG_IOCTL_BASE, 0, struct
watchdog_info)
#define WDIOC_GETSTATUS _IOR(WATCHDOG_IOCTL_BASE, 1, int)
#define WDIOC_GETBOOTSTATUS _IOR(WATCHDOG_IOCTL_BASE, 2, int)
#define WDIOC_GETTEMP _IOR(WATCHDOG_IOCTL_BASE, 3, int)
#define WDIOC_SETOPTIONS _IOR(WATCHDOG_IOCTL_BASE, 4, int)
#define WDIOC_KEEPAWAKE _IOR(WATCHDOG_IOCTL_BASE, 5, int)
#define WDIOC_SETTIMEOUT _IOWR(WATCHDOG_IOCTL_BASE, 6, int)
#define WDIOC_GETTIMEOUT _IOR(WATCHDOG_IOCTL_BASE, 7, int)
#define WDIOC_SETPRETIMEOUT _IOWR(WATCHDOG_IOCTL_BASE, 8, int)
#define WDIOC_GETPRETIMEOUT _IOR(WATCHDOG_IOCTL_BASE, 9, int)
#define WDIOC_GETTIMELEFT _IOR(WATCHDOG_IOCTL_BASE, 10, int)

#define WDIOF_UNKNOWN -1 /* Unknown flag error */
#define WDIOS_UNKNOWN -1 /* Unknown status error */

#define WDIOF_OVERHEAT 0x0001 /* Reset due to CPU overheat */
#define WDIOF_FANFAULT 0x0002 /* Fan failed */
#define WDIOF_EXTERN1 0x0004 /* External relay 1 */

```

```
#define WDIOF_EXTERN2      0x0008 /* External relay 2 */
#define WDIOF_POWERUNDER  0x0010 /* Power bad/power fault */
#define WDIOF_CARDRESET   0x0020 /* Card previously reset the CPU */
#define WDIOF_POWEROVER   0x0040 /* Power over voltage */
#define WDIOF_SETTIMEOUT  0x0080 /* Set timeout (in seconds) */
#define WDIOF_MAGICCLOSE  0x0100 /* Supports magic close char */
#define WDIOF_PRETIMEOUT  0x0200 /* Pretimeout (in seconds), get/set */
#define WDIOF_KEEPLIVEPING 0x8000 /* Keep alive ping reply */

#define WDIOS_DISABLECARD 0x0001 /* Turn off the watchdog timer */
#define WDIOS_ENABLECARD  0x0002 /* Turn on the watchdog timer */
#define WDIOS_TEMPPANIC   0x0004 /* Kernel panic on temperature trip */

#endif /* ifndef _LINUX_WATCHDOG_H */
```

## APPENDIX B PROGRAMMABLE DIGITAL I/O

### About Programmable Digital I/O

The AIE110-ONX supports 8 channels programmable digital I/O which allows user to program the DI or DO. For more details, please refer to the below sample code.

### B.1 Default Setting & Command Format

#### THE DEFAULT SETTING:

DIO1 ~ 8 are all **INPUT**



**Note:** The DIO protocol will reset to the default setting after a cold boot.

#### COMMAND FORMAT:

```
# i2cset -f -y <i2c_num> <device_addr> <reg_addr> <value>  
# i2cget -f -y <i2c_num> <device_addr> <reg_addr>
```

#### [For Example]

<i2c\_num>: 7

<device\_adrr>: 0x24

<reg\_addr>: 0x00~0x03 (as below Register Table)

<value>:

- Bit0 -> DIO1, Low: 0 High: 1
- Bit1 -> DIO2, Low: 0 High: 1
- ...
- Bit7 -> DIO8, Low: 0 High: 1

## B.2 Sample Program

### 1. DIO Output Sample Code

```
# i2cset -f -y 7 0x24 0x01 0xFF //Set DIO1 ~ 8 as High
# i2cset -f -y 7 0x24 0x03 0x00 //Set DIO1 ~ 8 as Output
# i2cset -f -y 7 0x24 0x01 0xF0 //Set DIO1 ~ 4 as Low and DIO5~8 as High
# i2cset -f -y 7 0x24 0x01 0x01 //Set DIO1 as High and DIO2~8 as Low
# i2cset -f -y 7 0x24 0x03 0x0F //Set DIO1 ~ 4 as Input and DIO5~8 as Output
...

```

### 2. DIO Input Sample Code

```
# i2cset -f -y 7 0x24 0x03 0xFF //Set DIO1 ~ 8 as Input
# i2cget -f -y 7 0x24 0x00 //Read all inputs
...

```

## B.3 Register Table

Register 0 - Input Port Register Bit Description

Bit	Symbol	Access	Value	Description
7	I7	read only	X	Determined by externally applied logic level
6	I6	read only	X	
5	I5	read only	X	
4	I4	read only	X	
3	I3	read only	X	
2	I2	read only	X	
1	I1	read only	X	
0	I0	read only	X	



**Register 1 - Output Port Register Bit Description**

This register reflects the outgoing logic levels of the pins defined as outputs by Register 3. Bit values in this register have no effect on pins defined as inputs. Reads from this register return the value that is in the flip-flop controlling the output selection, **not** the actual pin value.

Legend: \* default value

Bit	Symbol	Access	Value	Description
7	O7	R	1*	Reflects outgoing logic levels of pins defined as outputs by Register 3
6	O6	R	1*	
5	O5	R	1*	
4	O4	R	1*	
3	O3	R	1*	
2	O2	R	1*	
1	O1	R	1*	
0	O0	R	1*	

**Register 3 - Configuration Register Bit Description**

This register configures the directions of the I/O pins. If a bit in this register is set, the corresponding port pin is enabled as an input with high-impedance output driver. If a bit in this register is cleared, the corresponding port pin is enabled as an output. At reset, the I/Os are configured as inputs with a weak pull-up to  $V_{DD}$ .

Legend: \* default value

Bit	Symbol	Access	Value	Description
7	C7	R / W	1*	Configures the directions of the I/O pins 0 = corresponding port pin enabled as an output 1 = corresponding port pin configured as input (default value)
6	C6	R / W	1*	
5	C5	R / W	1*	
4	C4	R / W	1*	
3	C3	R / W	1*	
2	C2	R / W	1*	
1	C1	R / W	1*	
0	C0	R / W	1*	