

USER'S MANUAL

UST500-517-FL Series

Embedded System

User's Manual



www.axiomtek.com

Disclaimers

This manual has been carefully checked and believed to contain accurate information. Axiomtek Co., Ltd. assumes no responsibility for any infringements of patents or rights of any third party, or any liability arising from such uses.

Axiomtek does not warrant or assume any legal liability or responsibility for the accuracy, completeness or usefulness of any information in this document. Axiomtek does not make any commitment to update any information in this manual.

Axiomtek reserves the right to change or revise this document and/or product at any time without notice.

No part of this document may be reproduced, stored in a retrieval system, or transmitted in any forms or by any means, electronic, mechanical, photocopying, recording, among others, without prior written permissions of Axiomtek Co., Ltd.

©Copyright 2023 Axiomtek Co., Ltd.

All Rights Reserved

June 2023, Version A9

Printed in Taiwan

Safety Precautions

Before getting started, please read the following important safety precautions.

1. The UST500-517-FL does not come with an operating system which must be loaded first before installation of any software into the computer.
2. Be sure to ground yourself to prevent static charge when installing any internal components. Use a grounding wrist strap and place all electronic components in any static-shielded devices. Most electronic components are sensitive to static electrical charge.
3. Disconnect the power cord from the UST500-517-FL prior to making any installation. Be sure both the system and all external devices are turned OFF. Sudden surge of power could ruin sensitive components. Make sure the UST500-517-FL is properly grounded.
4. Make sure the voltage of the power source is correct before connecting it to any power outlet.
5. Turn OFF system power before cleaning. Clean the system using a cloth only. Do not spray any liquid cleaner directly onto the screen.
6. Do not leave equipment in an uncontrolled environment where the storage temperature is below -40°C or above 80°C as it may damage the equipment.
7. Do not open the system's back cover. If opening the cover for maintenance is a must, only a trained technician is allowed to do so. Integrated circuits on computer boards are sensitive to static electricity. To avoid damaging chips from electrostatic discharge, observe the following precautions:
 - Before handling a board or integrated circuit, touch an unpainted portion of the system unit chassis for a few seconds. This will help discharge any static electricity on human body.
 - When handling boards and components, wear a grounding wrist strap available from most electronic component stores.
8. Follow these simple precautions to protect yourself from harm and the products from damage.
 - To avoid electrical shock, always disconnect the power from the PC chassis before manual handling. Do not touch any components on the motherboard while the PC is powered on.
 - Disconnect the power before making any configuration changes. A sudden rush of power after connecting a jumper or installing a card may damage sensitive electronic components.

Battery Information

Batteries, battery packs, and accumulators must not be disposed of as unsorted household waste. Please use the public collection system to return, recycle, or treat such items in compliance with local regulations.



※ Cautions are included to help prevent hardware damage and data losses.



For example,

The battery is at risk of exploding if incorrectly installed. Do not attempt to recharge, force open, or heat the battery. Replace the battery only with the same or equivalent type recommended by the manufacturer. Discard used batteries according to the manufacturer's instructions."

※ As for the RTC battery used in the system, when the battery voltage drops below 2.5V, the REAL-TIME CLOCK (RTC) RAM in the CMOS will be cleared, including the date, time, system password, and system configuration parameters. At this point, the battery must be replaced, and all parameters need to be reconfigured. Please refer to Chapter 2.4 for instructions on how to replace the battery.

Classifications

1. Degree of protection against electric shock: not classified.
2. Degree of protection against ingress of water: IP40/30*
3. Equipment not suitable for use in the presence of a flammable anesthetic mixture with air, oxygen or nitrous oxide.
4. Mode of operation: Continuous

*Please refer the IP rating for UST500 SKUs in 1.6 Model List.

General Cleaning Tips

Please keep the following precautions in mind while understanding the details fully before and during any cleaning of the computer and any components within.

A piece of dry cloth is ideal to clean the device.

1. Be cautious of any tiny removable components when using a vacuum cleaner to absorb dirt on the floor.
2. Turn the system off before cleaning up the computer or any components within.
3. Avoid dropping any components inside the computer or getting circuit board damp or wet.
4. For cleaning, be cautious of all kinds of cleaning solvents or chemicals which may cause allergy to certain individuals.
5. Keep foods, drinks or cigarettes away from the computer.

Cleaning Tools:

Although many companies have created products to help improve the process of cleaning computers and peripherals, users can also use household items accordingly for cleaning. Listed below are items available for cleaning computers or computer peripherals.

Pay special attention to components requiring designated products for cleaning as mentioned below.

- Cloth: A piece of cloth is the best tool to use when rubbing up a component. Although paper towels or tissues can be used on most hardware as well, it is recommended to use a piece of cloth.
- Water or rubbing alcohol: A piece of cloth may be somewhat moistened with water or rubbing alcohol before being rubbed on the computer. Unknown solvents may be harmful to plastic parts.
- Vacuuming dust, dirt, hair, cigarette and other particles out of a computer can be one of the best methods of cleaning a computer. Over time these items may restrict the airflow in a computer and cause circuitry to corrode.
- Cotton swabs: Cotton swabs moistened with rubbing alcohol or water are applicable to reach areas in keyboard, mouse and other areas.
- Foam swabs: If possible, it is better to use lint- free swabs such as foam swabs.



【Note】 : *It is strongly recommended that the user should shut down the system before starting to clean any single component.*

Please follow the steps below:

1. Close all application programs;
2. Close operating software;
3. Turn off power;
4. Remove all devices;
5. Pull out the power cable.

Scrap Computer Recycling

Please inform the nearest Axiomtek distributor as soon as possible for suitable solutions in case computers require maintenance or repair; or for recycling in case computers are out of order.

Trademarks Acknowledgments

Axiomtek is a trademark of Axiomtek Co., Ltd.

IBM, PC/AT, PS/2, VGA are trademarks of International Business Machines Corporation. Intel® and Pentium® are registered trademarks of Intel Corporation.

MS-DOS, Microsoft C and QuickBasic, Windows 10, Windows 8.1, Windows 8, Windows 7, Windows XPE, Windows XP, Windows CE embedded, Linux are trademarks of Microsoft Corporation.

Other brand names and trademarks are the properties and registered brands of their respective owners.

Table of Contents

Disclaimers.....	ii
Safety Precautions.....	iii
Battery Information	iv
Classifications.....	v
General Cleaning Tips	vi
Scrap Computer Recycling.....	vii
SECTION 1 INTRODUCTION.....	1
1.1 General Descriptions	1
1.2 System Specifications	2
1.2.1 Driver Contents	4
1.3 Dimensions.....	5
1.3.1 UST500-517-FL FOR 4SATA TRAY Dimensions	5
1.3.2 UST500-517-FL FOR 2SATA TRAY Dimensions.....	6
1.3.3 UST500-517-FL FOR NO TRAY Dimensions	7
1.4 I/O Outlets.....	8
1.5 Packing List.....	12
1.6 Model List	13
SECTION 2 HARDWARE INSTALLATION.....	15
2.1 Installing CPU	15
2.2 Installing SO-DIMM	18
2.3 Installing thermal pads.....	19
2.4 Installing RTC Battery	20
2.5 Installing 2.5" SATA Device	21
2.5.1 Installing 2.5" SATA Device for 4SATA	21
2.5.2 Installing 2.5" SATA Device for 2SATA	22
2.5.3 Installing 2.5" SATA Device for No Tray	24
2.6 Installing Mini PCIe Module.....	25
2.6.1 Installing Mini PCIe Module for 4SATA.....	25
2.6.2 Installing Mini PCIe Module for 2SATA.....	27
2.6.3 Installing Mini PCIe Module for No Tray	28
2.7 Installing 4G/3G Module	29
2.7.1 Installing 4G/3G Module for 4SATA	29
2.7.2 Installing 4G/3G Module for 2SATA	34
2.7.3 Installing 4G/3G Module for No Tray	38
2.8 Installing the Wall Mount Kit	41
2.8.1 Installing the Wall Mount Kit for 2SATA/4SATA.....	41
2.8.2 Installing the Wall Mount Kit for No Tray	41
2.9 Installing the Cable Fixing Plate	42
2.9.1 Installing the HDMI Cable Fixing Plate	42
2.9.2 Audio Cable Installation	42
SECTION 3 DIP SWITCH, BUTTON & CONNECTOR SETTINGS.....	43
3.1 Summary of DIP Switch Settings	43
3.2 Buttons	44
3.2.1 Power Button.....	44
3.2.2 Reset Button	44
3.3 Connectors	45
3.3.1 DC-in Power Connector	45

3.3.2	HDMI Connector	46
3.3.3	DVI-D Connector	46
3.3.4	VGA Connector	46
3.3.5	Serial Port Connector(COM1~COM2)	46
3.3.6	Ethernet & Power of Ethernet Connector (LAN1~LAN16)	47
3.3.7	USB 3.0 Connector	48
3.3.8	Audio Connector	48
3.3.9	Digital I/O	48
3.3.10	SATA Connector (SATA 1~4)	49
3.3.11	SATA Power Connector	49
3.3.12	SIM Card Slots (S1~S2).....	49
3.3.13	PCI Express Mini Card Slot	50
SECTION 4 BIOS SETUP UTILITY		53
4.1	Starting	53
4.2	Navigation Keys	53
4.3	Main Menu	54
4.4	Advanced Menu	55
4.5	Chipset Menu	75
4.6	Boot Menu	80
4.7	Save & Exit Menu	81
APPENDIX A WATCHDOG TIMER		83
	About Watchdog Timer	83
	How to Use the Watchdog Timer	83
	Sample Program	83
APPENDIX B DIGITAL I/O		85
APPENDIX C CONFIGURING SATA FOR RAID.....		91
APPENDIX D POWER BUTTON SETTING FOR WINDOWS.....		99

This page is intentionally left blank.

SECTION 1 INTRODUCTION

This section contains general information and detailed specifications of the UST500-517-FL. Section 1 consists of the following sub-sections:

- General Descriptions
- System Specifications
- Dimensions
- I/O Outlets
- Packing List
- Model List

1.1 General Descriptions

The UST500-517-FL is a fanless embedded system powered by the 7th / 6th generation Intel® Core™ i7/i5/i3 and Celeron® processor (formally codenamed: Kaby Lake / Skylake) and comes with flexible I/O design. To fulfill different application needs, the flexible embedded system supports WE8S, WES7, Windows® 10 and Linux, and can be wall-mounted or DIN-rail mounted as an optional request.

The UST500-517-FL is built with an IP40-rated* heavy-duty aluminum extrusion, enabling reliable operation in harsh environments. Moreover, it features a wide range of 9 to 36V DC power input with power protection and -40 °C to +70 °C extended operating temperature support. To help minimize deployment time, this fanless embedded PC provides one optional I/O door for customers to easily install additional I/O output, making it perfectly suitable for any transportation applications.

*Please refer the IP rating for UST500 SKUs in 1.6 Model List.

Features

- LGA1151 socket 7th / 6th generation Intel® Core™ i7/i5/i3 & Celeron® processor (Kaby Lake / Skylake) with Intel®Q170
- Supports wide range of DC power input from 9 to 36VDC (Typical 24VDC).
- One DVI-D, one HDMI and VGA with triple view supported
- Multiple flexible I/O modules supported

Reliable and Stable Design

The UST500-517-FL embedded system supports 7th / 6th generation Intel® Core™ i7/i5/i3 and Celeron® processors, with high flexibility and multi-functional design to present the best solution for any transportation applications.

Flexible Connectivity

The UST500-517-FL comes with rich I/O interfaces including two RS-232/422/485 ports, four USB 3.0 ports, 6-CH isolated digital Input / 2-CH isolated digital Output, and sixteen GbE LAN ports.

Embedded O.S. Supported

With the Skylake processor, UST500-517-FL can support WIN 7/8/10 and Linux

With the Kabylake processor, UST500-517-FL can support Windows® 10 64 Bit.

1.2 System Specifications

- **CPU**
 - LGA1151 socket 7th / 6th generation Intel® Core™ i7/i5/i3 & Celeron® processor, CPU TDP max. up to 35W/65W
- **Chipset**
 - Intel® Q170
- **BIOS**
 - American Megatrends Inc. UEFI (Unified Extensible Firmware Interface) BIOS.
- **System Memory**
 - Two 260-pin unbuffered DDR4-2133 MHz SO-DIMM sockets, up to 32 GB at the maximum for 6th / 7th generation Intel® Core™ processor
- **Display**
 - 1 x HDMI (Resolution:4K/2K@30Hz)
 - 1 x DVI-D (Resolution:2K@60Hz)
 - 1 x VGA (Resolution: 1920X1200@ @60Hz)
- **Ethernet & Power Over Ethernet**

All Ethernet ports use the I210-AT controller, which can support 10/100/1000 Mb/s speed , and different types of connectors can be provided for different skews for access. In addition, All ports support IEEE 802.3AF/AT (15.4W/25.5W) Power over Ethernet can provide both data connection and electric power to devices (eg. IP camera).



Note: UST500 is a power supply device. Two PSE devices should not be connected together, which may cause the risk of power conflict. Correctly connect PD Device or switch without PoE. If you need PoE switch, please find the switch with uplink port.

- **No Tray**
 - 8 ports RJ45
- **2 Tray**
 - 8 ports RJ45
 - 16 ports RJ45

- **4 Tray**
 - 8 ports M12
 - 8 ports RJ45 and 8ports M12
 - 16 ports RJ45
- **USB Ports**
 - 4 x USB 3.0
- **Serial Ports**
 - 2 x RS-232/422/485 (COM1~2)
- **DIO**
 - Isolated programmable 6DI / 2DO
- **Audio**
 - 2 x Audio (Mic-in, Line-out)
- **Mini Card Interface**
 - 2 x full-size PCI Express Mini Card Slots (USB + PCI Express signal)
 - 1 x half-size PCI Express Mini Card Slot (mSATA + USB + PCI Express signal)
 - 1 x half-size USB Mini Card Slots
 - 2 x SIM slots
- **Storage**
 - 2/4 x 2.5" SATA HDD/SSD drive tray
 - 1 x mSATA
- **Indicator**
 - 1 x Green LED as indicator for PWR status
 - 1 x Green LED as indicator for HDD active
 - 2 x Green LED as indicator for programmable
- **Button**
 - 1 x Power button
 - 1 x Reset button
- **Antenna**
 - 5 x SMA type connector openings for antenna
- **Watchdog Timer**
 - 1~255 seconds or minutes; up to 255 levels.
- **Power Supply**
 - 9~36VDC input (typical 24VDC input)
- **Operation Temperature**
 - -40 °C ~+70 °C (-40 °F ~ 158 °F), with W.T. SSD & Memory : Skylake/ Kaby Lake (Operating environment varies depending on the CPU model in use.)
- **Storage Temperature**
 - -40 °C ~+85 °C (-40 °F ~ 185 °F)
- **Humidity**
 - 10% ~ 95% (non-condensation)
- **Vibration Endurance**
 - No Tray
 - 3Grm with SSD (5-500Hz, X, Y, Z directions)
 - 2Grm with HDD (5~500Hz, X,Y, Z directions) (must be used with the Axiomtek Anti-Vibration Kit; please contact Axiomtek for details)
 - 2 SATA Tray
 - 3Grm with SSD (5-500Hz, X, Y, Z directions)
 - 2Grm with HDD (5~500Hz, X,Y, Z directions) (must be used with the Axiomtek Anti-Vibration Kit; please contact Axiomtek for details)

- 4 SATA Tray
 - 2Grms with SSD (5-500Hz, X, Y, Z directions)
 - 2Grms with HDD (5-500Hz, X,Y, Z directions) (must be used with the Axiomtek Anti-Vibration Kit; please contact Axiomtek for details)
- **Weight**
 - No Tray
 - 3.95 kg (8.71 lb) without package
 - 4.97 kg (10.96 lb) with package
 - 2 SATA Tray
 - 4.92 kg (10.85 lb) without package
 - 5.74 kg (12.65 lb) with package
 - 4 SATA Tray
 - 4.92 kg (10.85 lb) without package
 - 5.74 kg (12.65 lb) with package
- **Dimension**
 - 2 SATA internal drive without tray: 280 mm(11.02")(W) x 210.5 mm(8.27")(D) x 70 mm(2.76") (H)
 - 2 SATA drive trays: 280 mm(11.02")(W) x 210.5 mm(8.27")(D) x 83.7 mm(3.30")(H)
 - 4 SATA drive trays: 280 mm(11.02")(W) x 210.5 mm(8.27")(D) x 99.2 mm(3.91")(H)

1.2.1 Driver Contents

Please download the drivers from the Axiomtek official website.

- **Ethernet**
- **Chipset**
- **Graphic**
- **Serial Port**
- **USB 3.0**
- **Intel® ME**
- **Audio**
- **User's Manual**
- **UST500 Digital I/O utility**



【 Note 】 : All specifications and images are subject to change without notice.

1.3 Dimensions

The following diagrams show the dimensions and outlines of the UST500-517-FL.

1.3.1 UST500-517-FL FOR 4SATA TRAY Dimensions

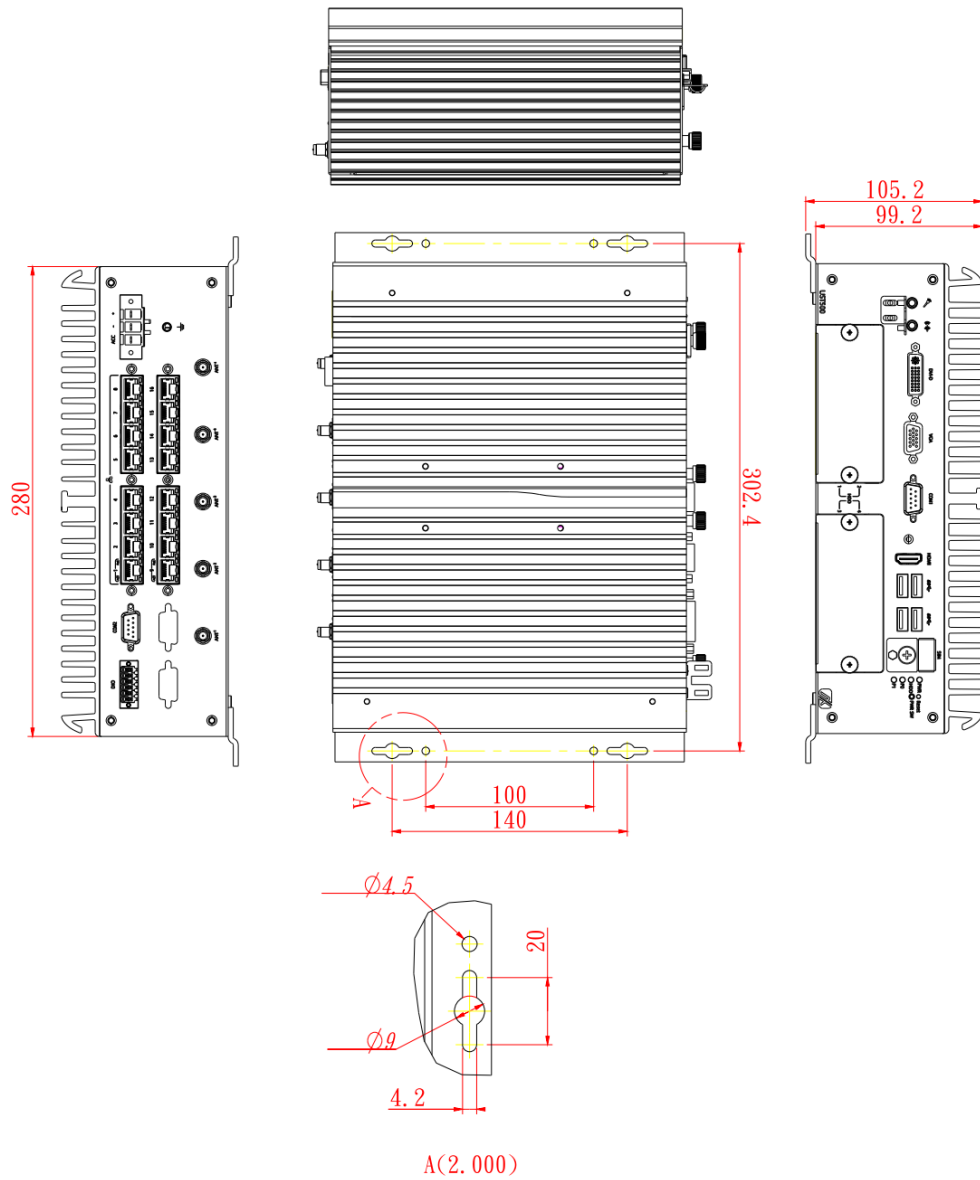

1.3.2 UST500-517-FL FOR 2SATA TRAY Dimensions

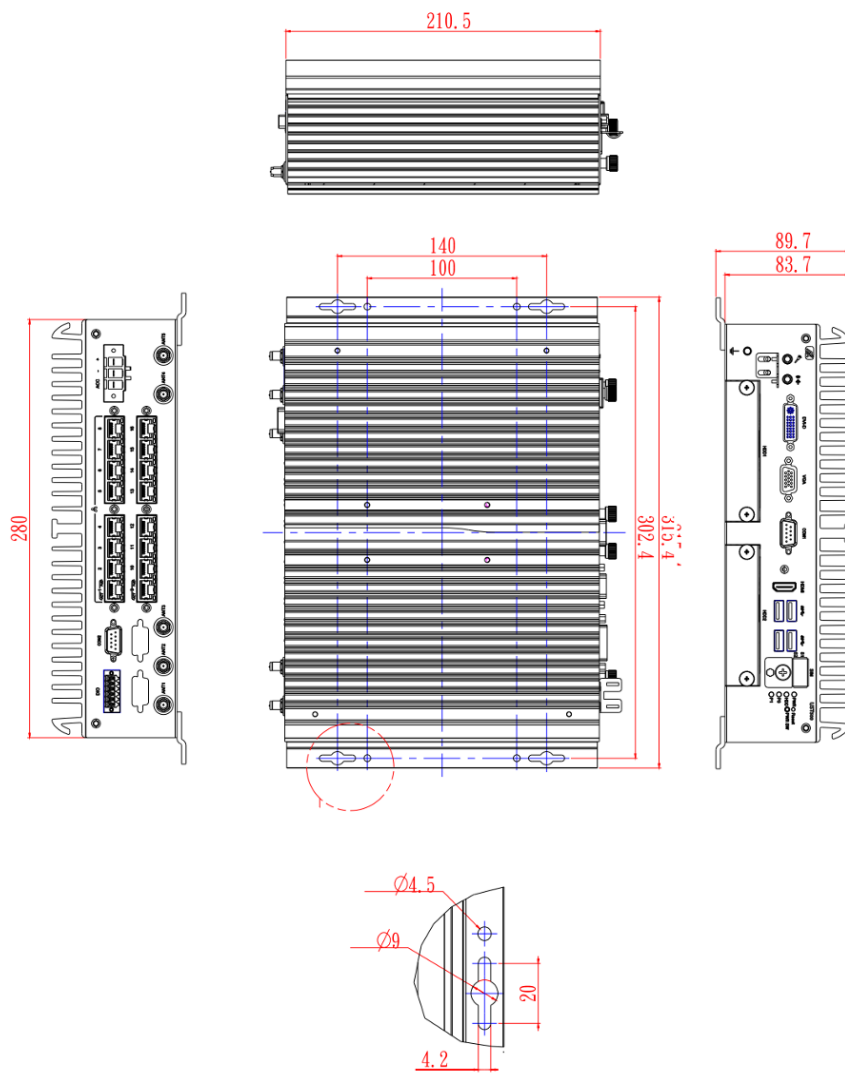

1.3.3 UST500-517-FL FOR NO TRAY Dimensions

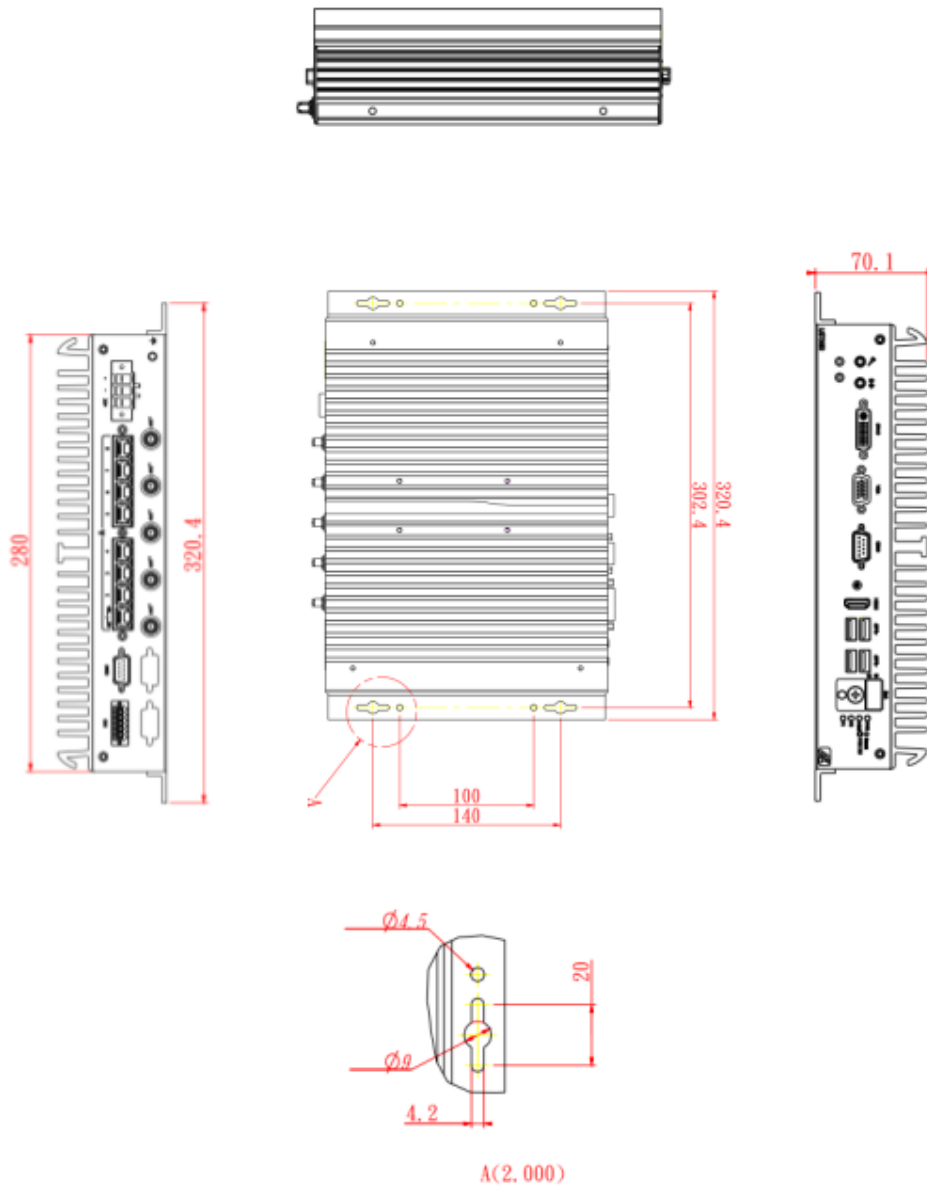

1.4 I/O Outlets

The following figures show I/O outlets on the UST500-517-FL.

Front View

UST500-517-FL-16RJ-4SATA-TDC / UST500-517-FL-8RJ8M12-4SATA-TDC

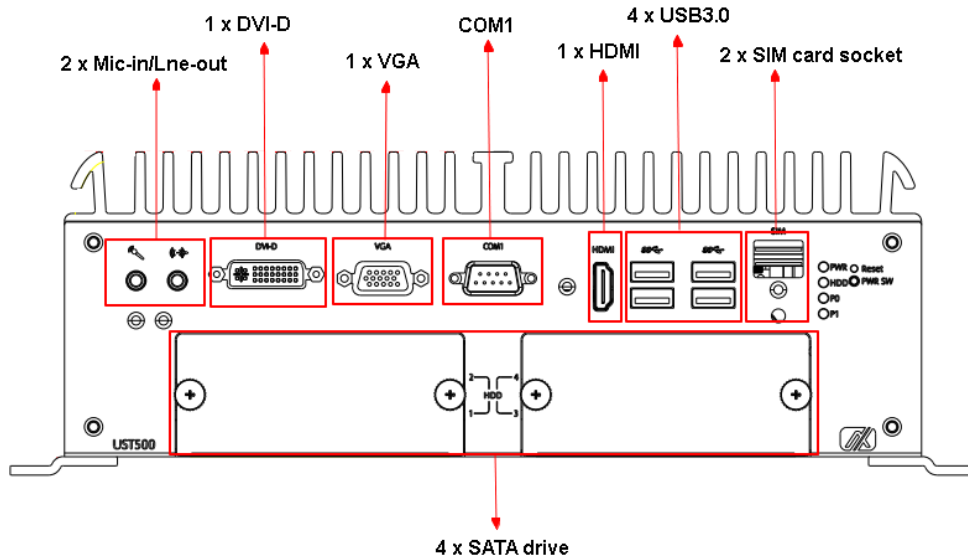

Rear View

UST500-517-FL-16RJ-4SATA-TDC

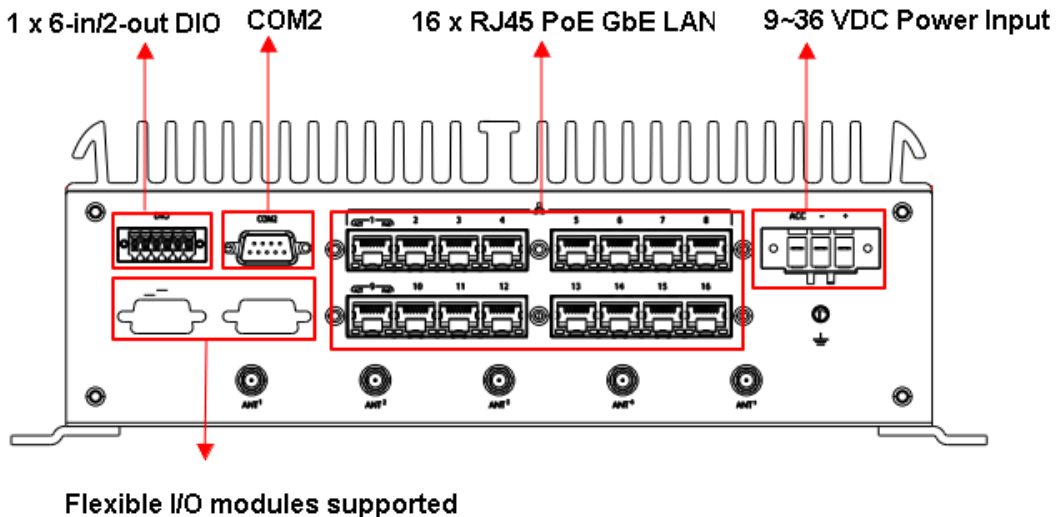

Rear View

UST500-517-FL-8RJ8M12-4SATA-TDC

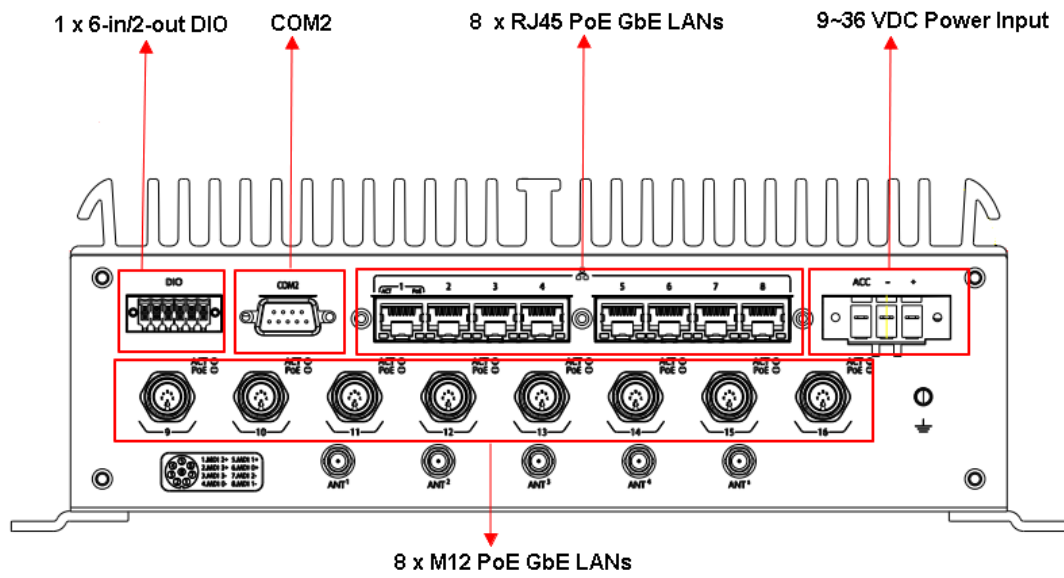

Front View

UST500-517-FL-16RJ-2SATA-TDC / UST500-517-FL-8RJ-2SATA-TDC

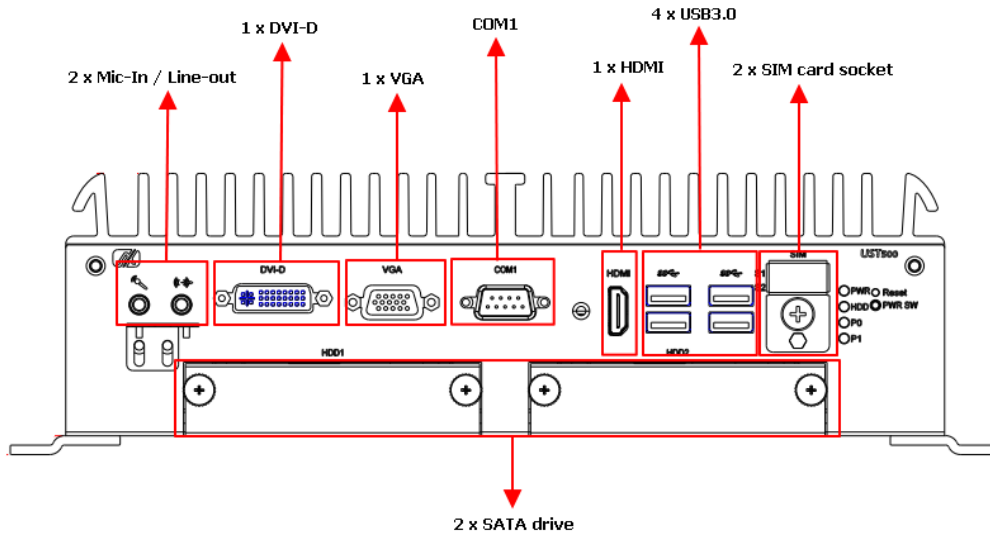

Rear View

UST500-517-FL-16RJ-2SATA-TRAY-TDC

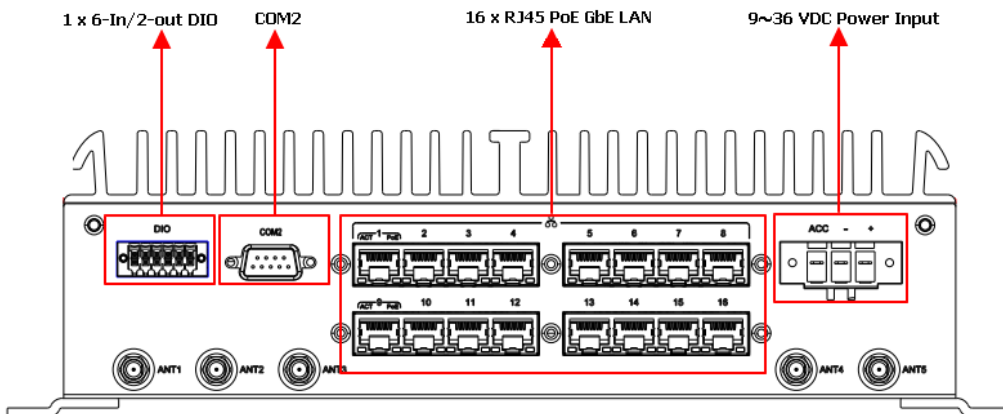

Rear View

UST500-517-FL-8RJ-2SATA-TRAY-TDC

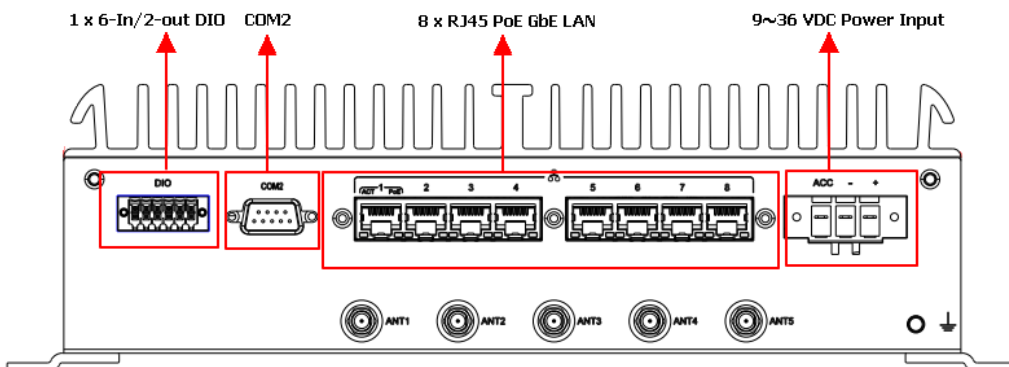

Front View
UST500-517-FL 2SATA-TDC

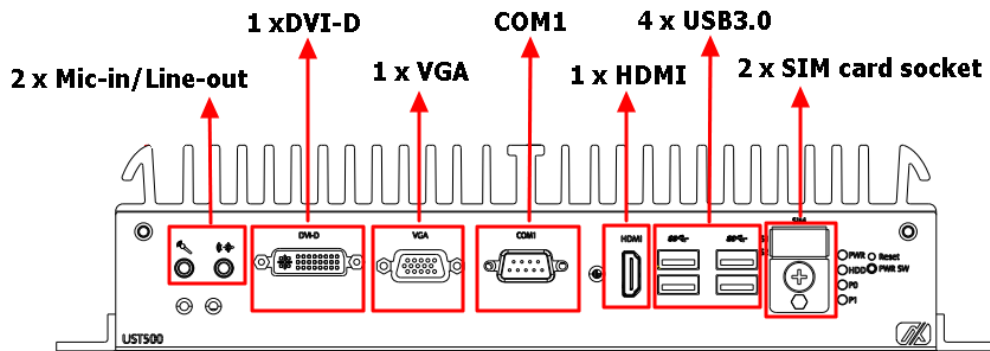

Rear View
UST500-517-FL 2SATA-TDC

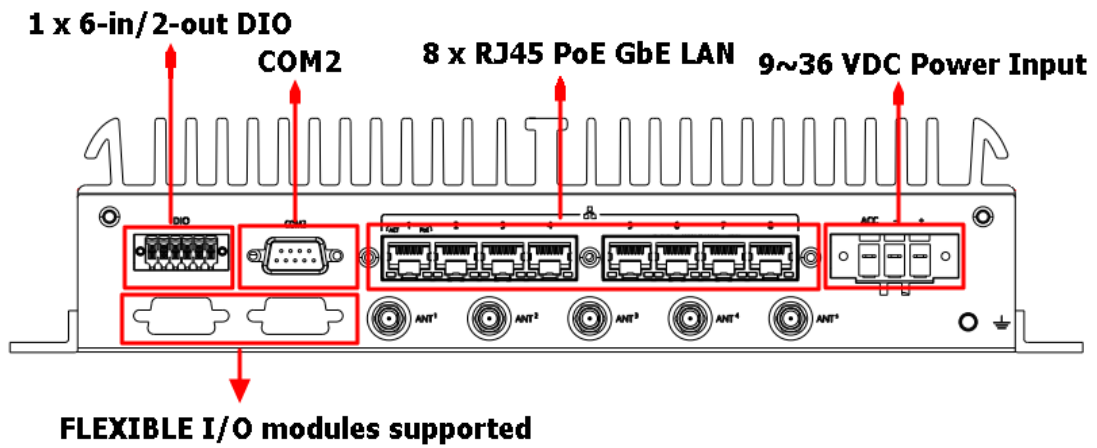

1.5 Packing List

The UST500-517-FL comes with the following bundle package:

No Tray	2 SATA Tray	4 SATA Tray
UST500-517-FL system unit x 1	UST500-517-FL system unit x 1	UST500-517-FL system unit x 1
CPU thermal pad x 1	CPU thermal pad x 1	CPU thermal pad x 1
Audio cable fixture x 1	Audio cable fixture x 1	Audio cable fixture x 1
HDMI cable fixture x 1	HDMI cable fixture x 1	HDMI cable fixture x 1
Cable fixture screws x 3	Cable fixture screws x 3	Cable fixture screws x 3
cable tie x 3	Cable tie x 3	Cable tie x 3
HDD screws x 8	HDD screws x 8	HDD screws x16
HDD holder x 2	Terminal block x 1	HDD Mylar x4
HDD holder screws x 8	Programming DI/DO connector x 1	Terminal block x 1
Terminal block x 1	Wall mount kit x 1	Programming DI/DO connector x 1
Programming DI/DO connector x 1	Wall mount kit screws x 4	Wall mount kit x1
Wall mount kit x 1	Mini Card slot screws x 8	Wall mount kit screws x 4
Wall mount kit screws x 4	RF isolated plastic spacer x 10	Mini Card Slot screws x 8
Mini Card slot screws x 8		RF isolated plastic spacer x 10
RF isolated plastic spacer x 10		

1.6 Model List

UST500-517-FL-16RJ-4SATA-TDC (P/N: E274500100)	Fanless embedded IP40 rated system with 6/7th gen Intel® desktop processor (LGA1151), Q170, VGA, DVI-D, HDMI, 6-in/2-out DIO, 2 COM, 4 USB 3.0, 16 RJ-45 PoE GbE LAN, 4 SATA swappable drives and ACC ignition.
UST500-517-FL-8RJ8M12-4SATA-TDC (P/N: E274500101)	Fanless embedded IP40 rated system with 6/7th gen Intel® desktop processor (LGA1151), Q170, VGA, DVI-D, HDMI, 6-in/2-out DIO, 2 COM, 4 USB 3.0, 8 M12 & 8 RJ-45 PoE GbE LAN, 4 SATA swappable drives and ACC ignition.
UST500-517-FL-8M12-4SATA-TDC (P/N: E274500102)	Fanless embedded IP40 rated system with 6/7th gen Intel® desktop processor (LGA1151), Q170, VGA, DVI-D, HDMI, 6-in/2-out DIO, 2 COM, 4 USB 3.0, 8 M12 PoE GbE LAN, 4 SATA swappable drives and ACC ignition.
UST500-517-FL-8RJ-2SATA-TDC (P/N: E274500103)	Fanless embedded IP40 rated system with 6/7th gen Intel® desktop processor (LGA1151), Q170, VGA, DVI-D, HDMI, 6-in/2-out DIO, 2 COM, 4 USB 3.0, 8 RJ-45 PoE GbE LAN, 2 SATA internal drives and ACC ignition.
UST500-517-FL-16RJ-2SATA-TRAY-TDC (P/N: E274500104)	Fanless embedded IP30 rated system with 6/7th gen Intel® desktop processor (LGA1151), Q170, VGA, DVI-D, HDMI, 6-in/2-out DIO, 2 COM, 4 USB 3.0, 16 RJ-45 PoE GbE LAN, 2 SATA swappable drives and ACC ignition.
UST500-517-FL-8RJ-2SATA-TRAY-TDC (P/N: E274500105)	Fanless embedded IP30 rated system with 6/7th gen Intel® desktop processor (LGA1151), Q170, VGA, DVI-D, HDMI, 6-in/2-out DIO, 2 COM, 4 USB 3.0, 8 RJ-45 PoE GbE LAN, 2 SATA swappable drives and ACC ignition.

Please contact an Axiomtek distributor immediately if any of the abovementioned item is missing.

This page is intentionally left blank.

SECTION 2 HARDWARE INSTALLATION

The UST500-517-FL is convenient for various hardware configurations, such as CPU, DRAM, HDD (Hard Disk Drive), SSD (Solid State Drive), and PCI Express Mini card modules. Section 2 contains guidelines for hardware installation.

2.1 Installing CPU

Step 1 Turn off the system and unplug the power cord.

Step 2 Loosen all screws to remove the top cover.

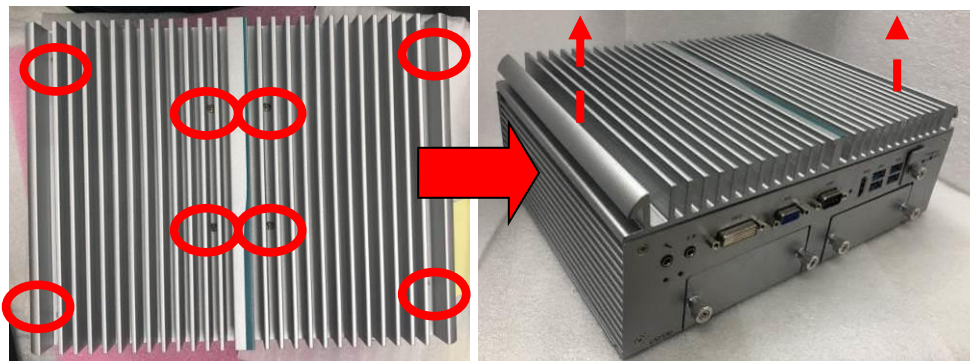

Step 3 Tear the protective cover off carefully.

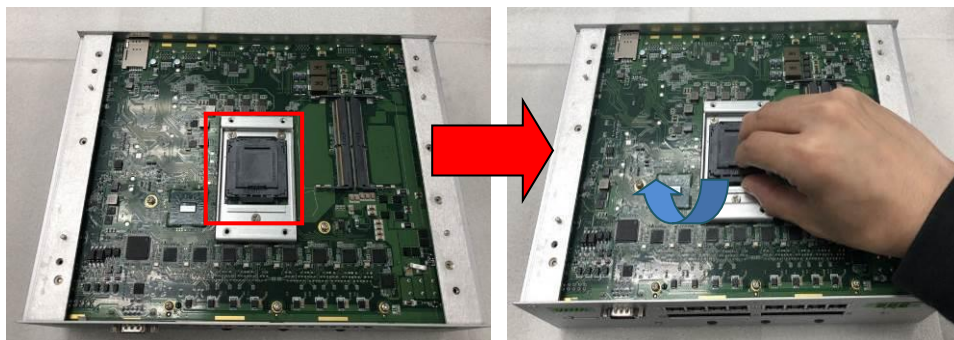

Step 4 CPU installation steps:

- Lift the processor package from shipping media by grasping the substrate edges.



- Scan the processor package gold pads for any presence of foreign material.
- Locate connection 1 indicator on the processor which aligns with connection 1 indicator chamfer on the socket, and notice processor keying features that line up with posts along socket walls.
- Grasp the processor with the thumb and index finger along the top and bottom edges. The socket will have cutouts for your fingers to fit into.
- Carefully place the processor into the socket body vertically.

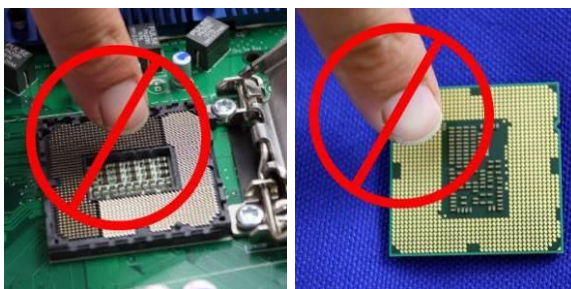
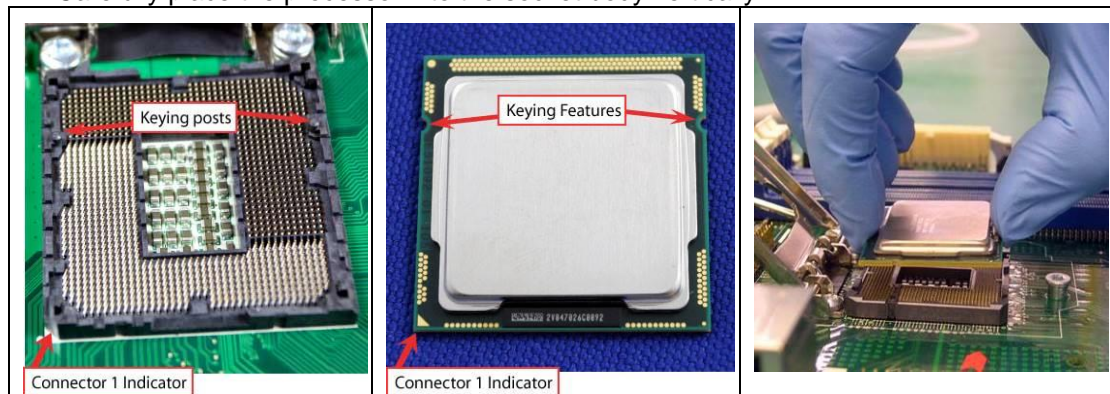

To avoid damage, never touch the fragile contacts of the socket and the processor at any time during installation.

Step 5 When installing the CPU, pay attention to the CPU's orientation and align the arrow mark on the CPU with the arrow key on the socket (Step 4). And apply the thermal pad on the top of the processor.

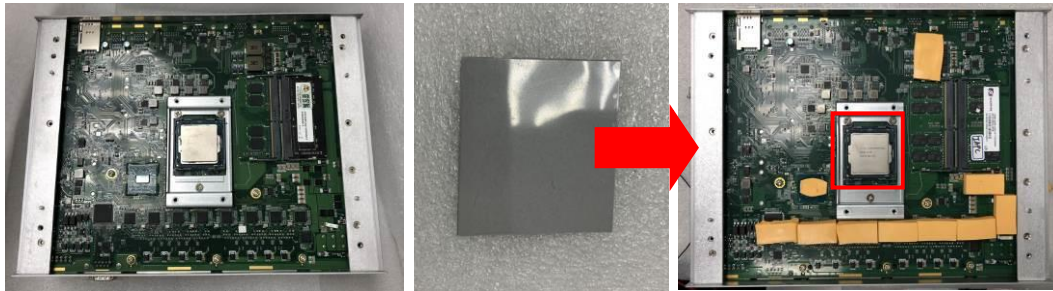

Step 6 Put the top cover back onto the system and fasten all screws.



【Note】 When removing the top cover to change accessories, the CPU will stick on the underside of the cover. To avoid damaging the CPU by squeezing, please take it down carefully by holding the edges of the CPU and follow section 2.1 to reinstall.

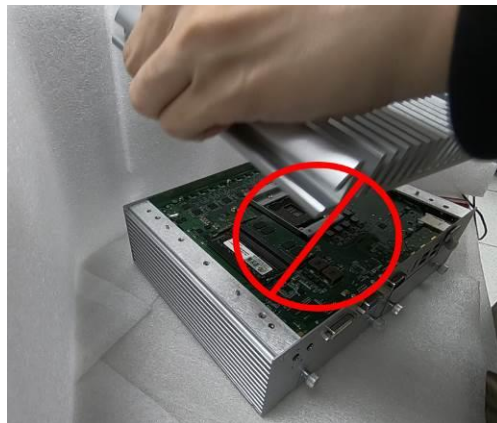

2.2 Installing SO-DIMM

Step 1 Turn off the system and unplug the power cord.

Step 2 Loosen all screws to remove the top cover.

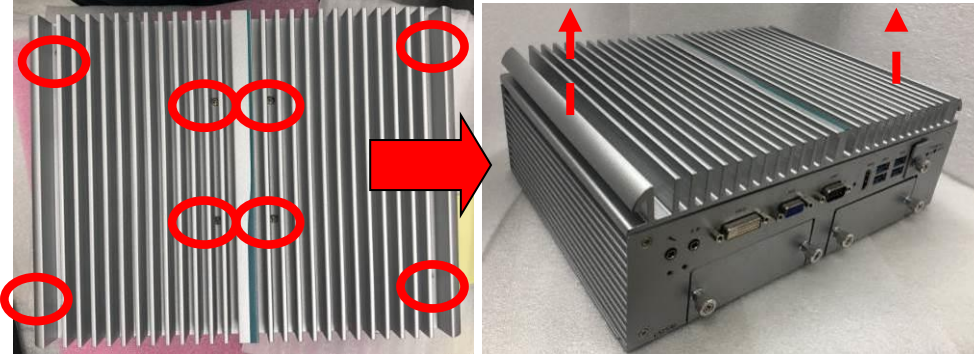

Step 3 Locate the dual SO-DIMM sockets on the main board.



Step 4 Insert the connecting finger of the memory module into the socket and push the two end latches down until locked.



Step 5 Put the top cover back onto the system and fasten all screws.

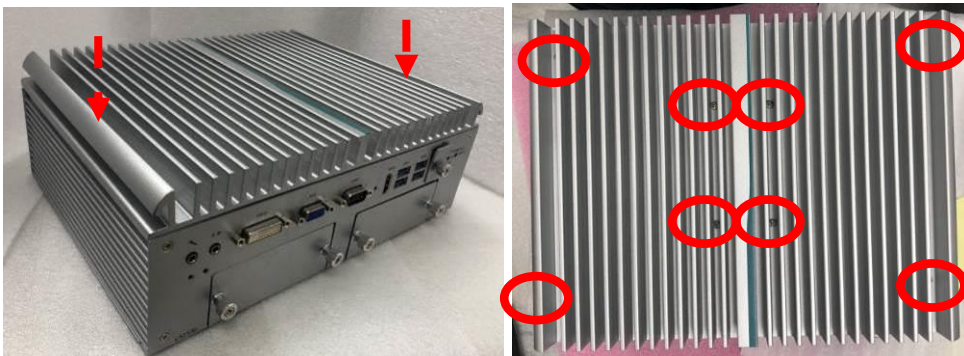

2.3 Installing thermal pads

Step 1 Turn off the system and unplug the power cord.

Step 2 Loosen all screws to remove the top cover.

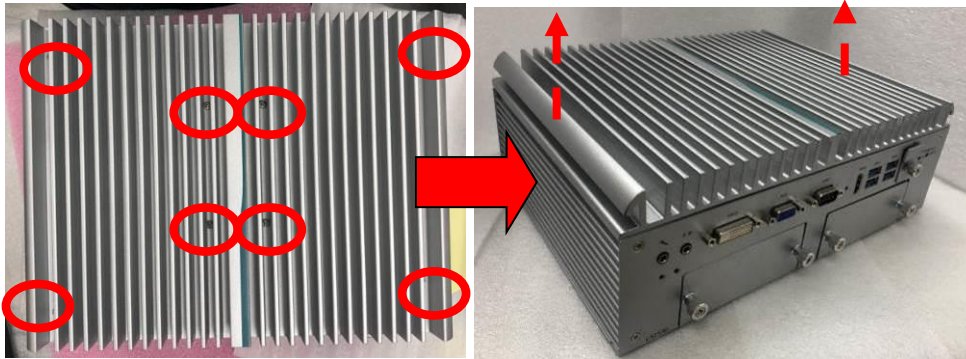

Step 3 Put the thermal pads on the marked secant locations.

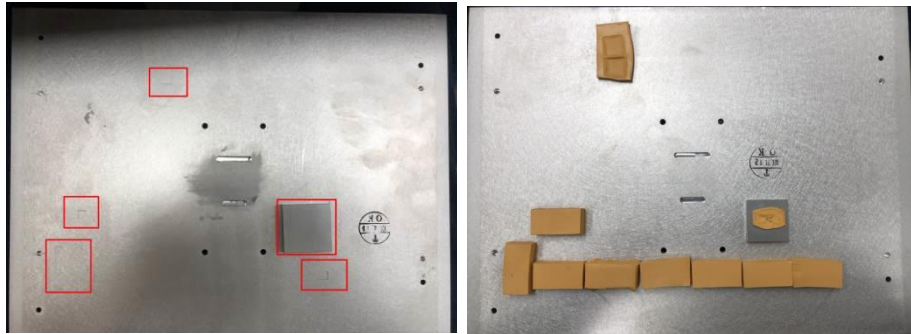

【Note】 It is suggested that the thermal pads be put on the motherboard's corresponding positions as shown.

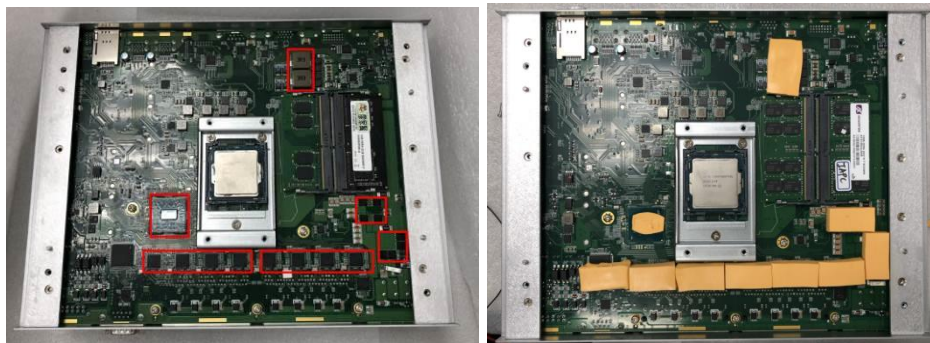

2.4 Installing RTC Battery

Step 1 Turn off the system and unplug the power cord.

Step 2 Turn the system upside down and loosen the SATA tray screws.

Step 3 Extract the SATA tray on the left side as shown.



Step 4 Loosen all screws and open the cover carefully.

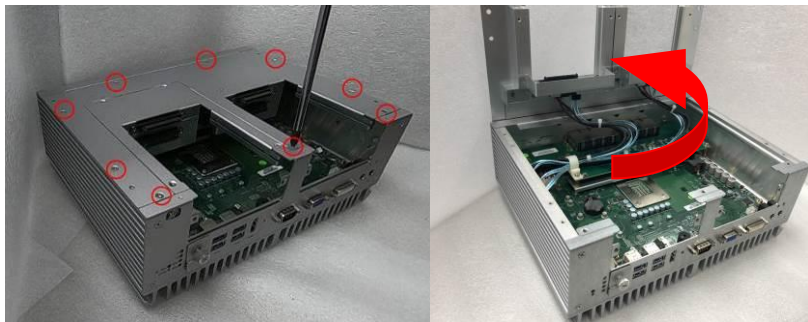

Step 5 Push the metal clasp and remove the RTC battery.

Step 6 Install the new RTC battery into the holder.

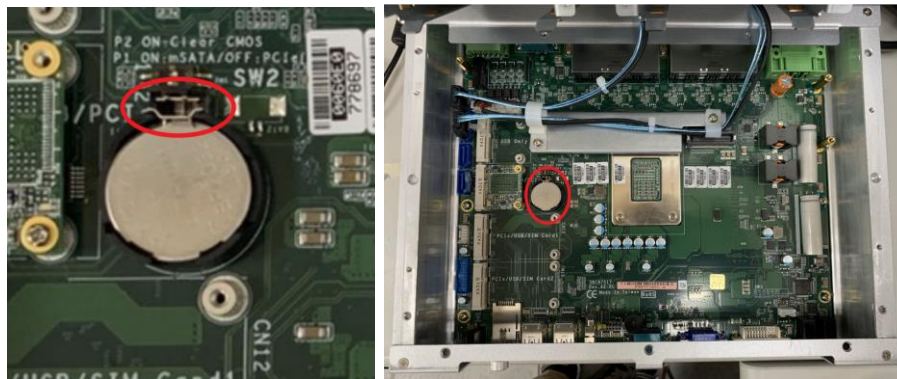

【Note】 The RTC battery voltage can be monitored by the BIOS utility, as explained in Chapter 4.4 of the BIOS NCT6106D Hardware Monitor in the Advanced Menu. It is important to ensure that the +VBAT voltage remains above 2.5V. Typically, the standard battery lifetime is over three years. In the situation that the +VBAT voltage drops below 2.5V, the BIOS/UEFI will automatically reset to the default values. In such cases, users are advised to replace the RTC battery according to the voltage requirements.

Step 7 Secure the cover back to the original position and fasten all screws tight.

2.5 Installing 2.5" SATA Device

2.5.1 Installing 2.5" SATA Device for 4SATA

Step 1 Turn off the system and unplug the power cord.

Step 2 Loosen all of the SATA drive tray's screws.



Step 3 Extract the SATA drive tray. Each drive tray can install two storage drives.



Step 4 Attach a piece of Mylar on the back of an HDD/SSD as shown.



Step 5 Turn the SATA drive tray upside down to install SSD/HDD and fasten the eight screws to secure the SATA drive tray.



Step 6 Slide the secured SATA drive tray back into the system and fasten the screws tight to complete the installation.



2.5.2 Installing 2.5" SATA Device for 2SATA

Step 1 Turn off the system and unplug the power cord.

Step 2 Loosen all of the SATA drive tray's screws.



Step 3 Extract the SATA drive tray. One drive tray can install two SSD/HDD drives.



Step 4 Turn the SATA drive tray upside down to install SSD/HDD and fasten the four screws to secure the SATA drive tray.

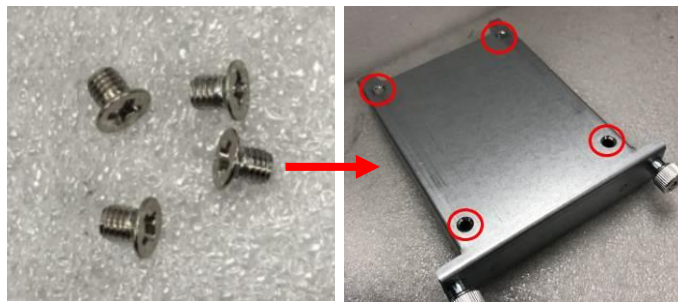

Step 5 Slide the secured SATA drive tray back into the system and fasten the screws firmly to complete the installation.



2.5.3 Installing 2.5" SATA Device for No Tray

Step 1 Turn off the system and unplug the power cord.

Step 2 Flip over the system and loosen all screws.

Step 3 Open the cover carefully and unplug the SATA cable.



Step 4 Install a HDD/SSD onto a drive holder by tightening HDD/SSD screws on the holder.



Step 5 Put the drive holders to precisely meet the screws hole positions and tighten screws.



Step 6 Plug the SATA cable into HDD/SSD.

Step 7 Place the cover back onto the original position with caution and tighten the screws firmly to complete the installation.

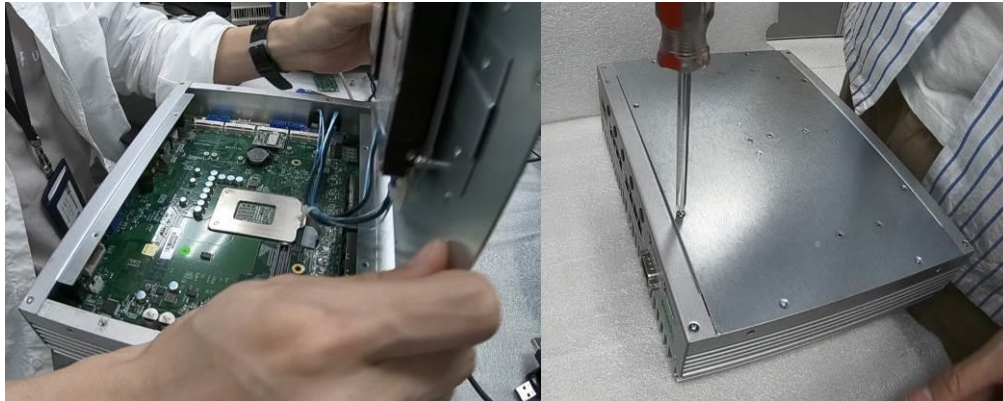

2.6 Installing Mini PCIe Module

2.6.1 Installing Mini PCIe Module for 4SATA

Step 1 Turn off the system and unplug the power cord.

Step 2 Turn the system upside down and loosen the SATA tray screws.

Step 3 Extract the SATA tray on the left side as shown.

Step 4 Loosen all screws and open the cover carefully.

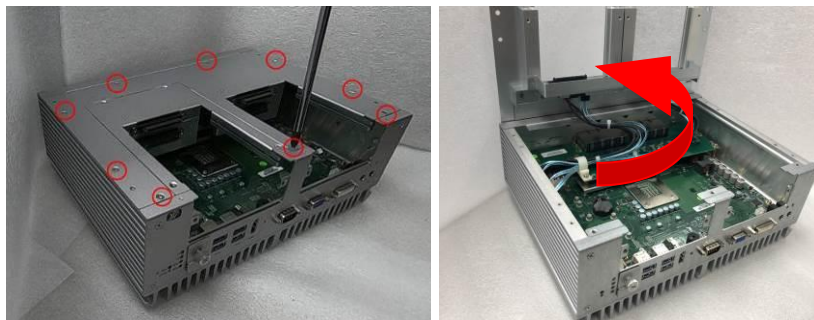

Step 5 Insert the PCIe card and fasten the screws as shown.

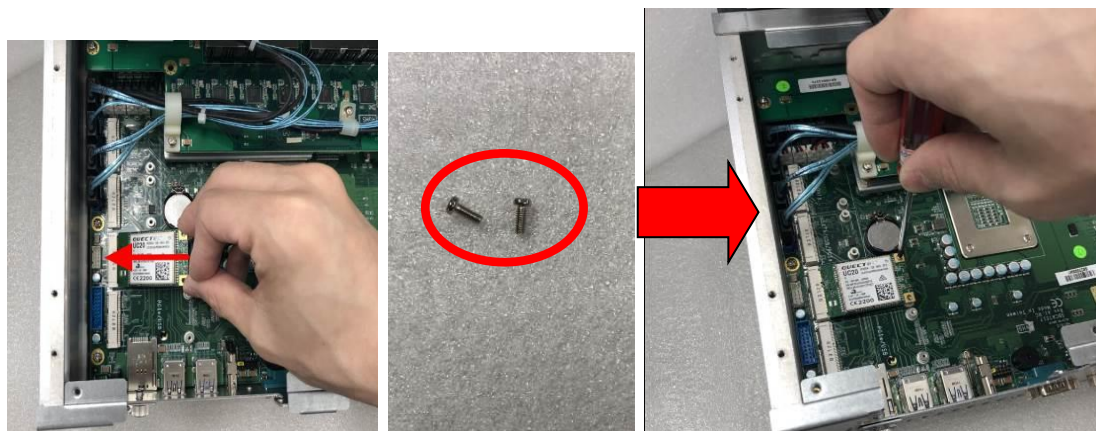

Step 6 Secure the cover back to the original position and fasten all screws tight.



Step 7 Slide the secured SATA tray back and fasten screws tight to complete the installation.



2.6.2 Installing Mini PCIe Module for 2SATA

Step 1 Turn off the system and unplug the power cord.

Step 2 Turn the system upside down and loosen the SATA trays.

Step 3 Extract both SATA trays as shown.



Step 4 Loosen all screws and open the bottom cover carefully.

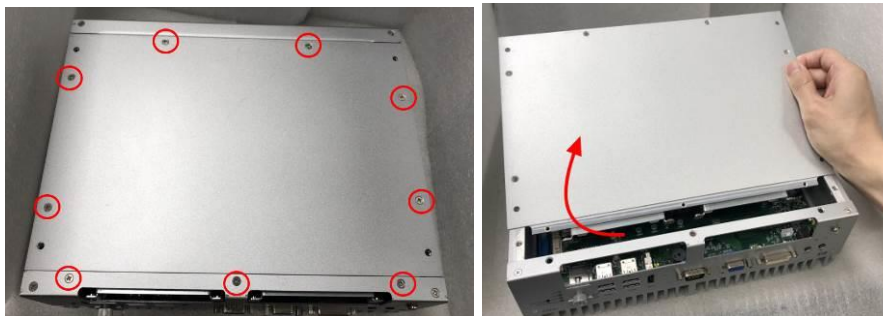

Step 5 Insert the PCIe card and fasten the screws as shown

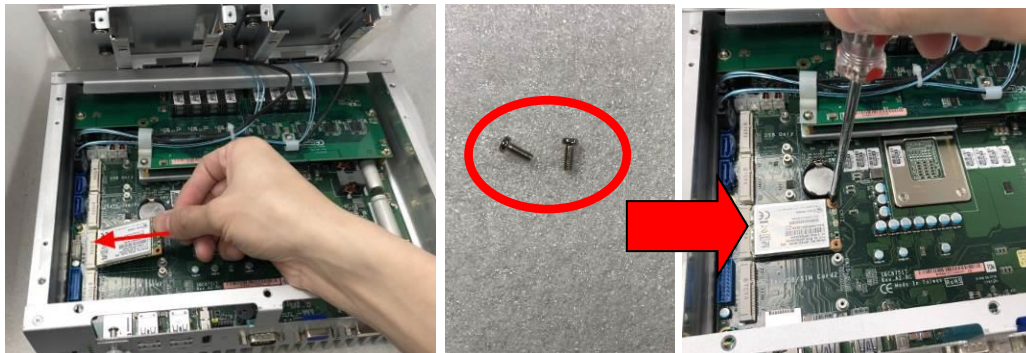

Step 6 Secure the cover back to original position and fasten all screws firmly.



Step 7 Slide the SATA trays back and fasten screws firmly to complete the installation.



2.6.3 Installing Mini PCIe Module for No Tray

Step 1 Turn off the system and unplug the power cord.

Step 2 Flip over the system and loosen the cover screws.

Step 3 Open the cover carefully and unplug the SATA cable.

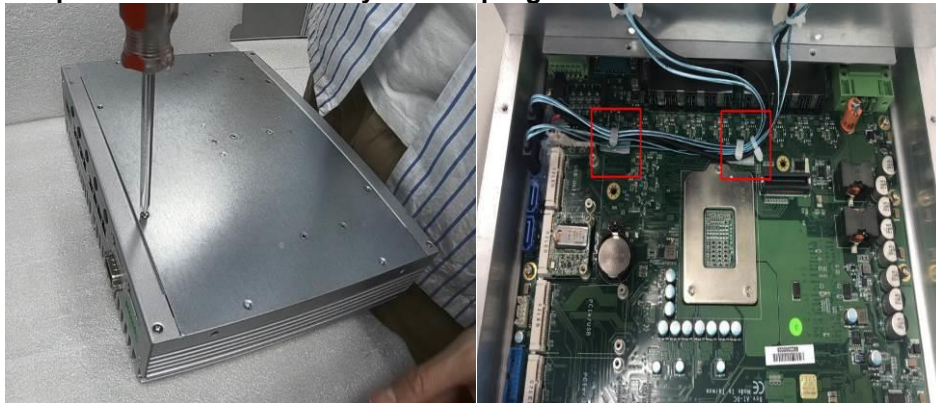

Step 4 Insert the PCIe card and fasten the screws as shown.

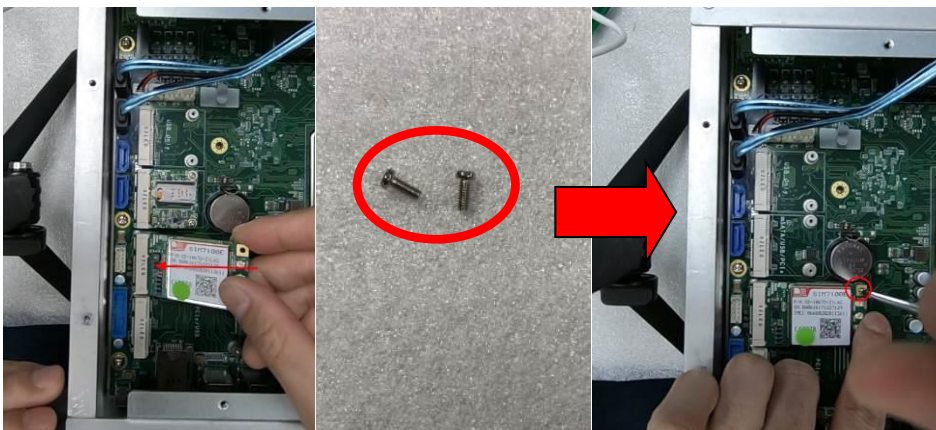

Step 5 Put the cover back and plug the SATA cable.

Step 6 Fasten all cover screws tight to complete the installation.

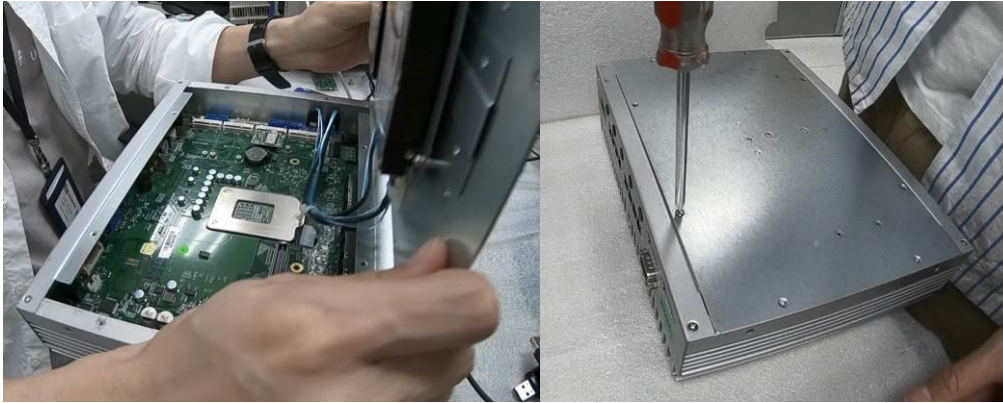

2.7 Installing 4G/3G Module

2.7.1 Installing 4G/3G Module for 4SATA

Step 1 Turn off the system and unplug the power cord.

Step 2 Turn the system upside down, and loosen the SATA tray screws.



Step 3 Extract all SATA trays.

Step 4 Loosen nine bottom cover screws as shown and open the cover carefully.

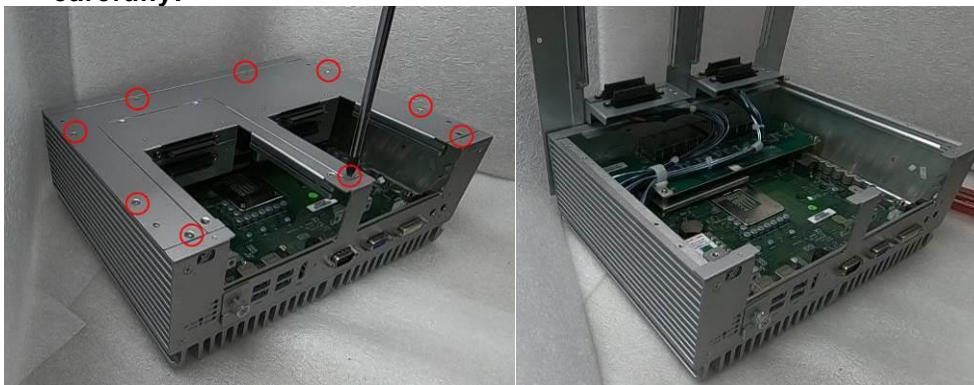

Step 5 Insert the wireless module (3G/4G/BT/GPS module etc.) into the slot with the marking "PCIe / USB".

Step 6 For instance, insert the 3G module and screw it tight.



Step 7 Remove the black plastic antenna plug cover from the rear panel.

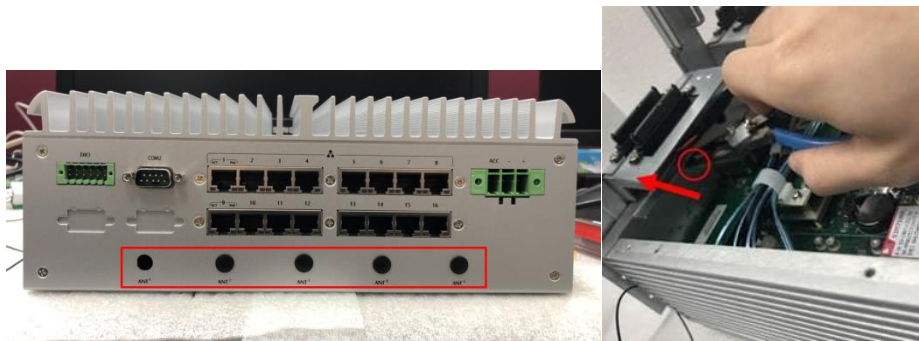

Step 8 Connect the RF cable to the connector of the 3G module marked with "MAIN".



Step 9 Put the larger plastic spacer over the other end of the RF cable (Figure 1) (Figure 2), and then insert the end of the RF cable through the antenna hole (Figure 3).



(Figure 1)



(Figure 2)

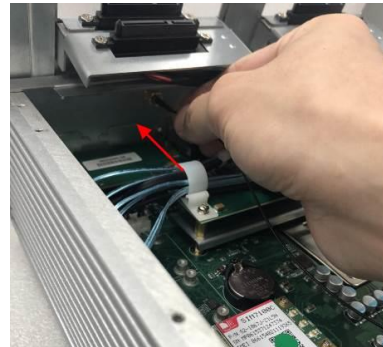

(Figure 3)

Step 10 Place the smaller plastic spacer over the end of the RF cable (Figure 5) and screw it tight with the fastening parts (Figure 4) (Figure 6) (Figure 7).



(Figure 4)



(Figure 5)



(Figure 6)



(Figure 7)

Step 11 Put the cover back onto the system, and fasten nine bottom screws tight.

Step 12 Slide and secure SATA trays back to complete the installation.

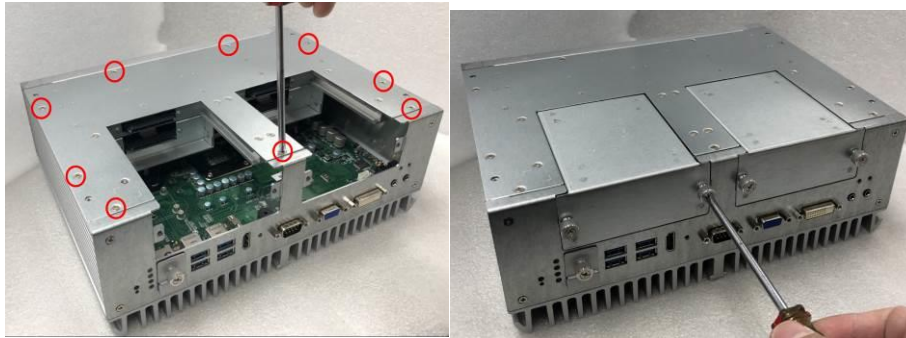

Step 13 Turn the system back to its upright position, and screw the RF antenna tight.



Step 14 Loosen the SIM cover one screw and insert the SIM card.





【Note】 The system provides two PCIe slots for SIM card installation. Pay attention to the orientation when inserting a SIM card: The SIM card's contacts must face downward when the card is being inserted into the SIM1 slot; the card's contacts must face upward when it is being inserted into the SIM2 slot.

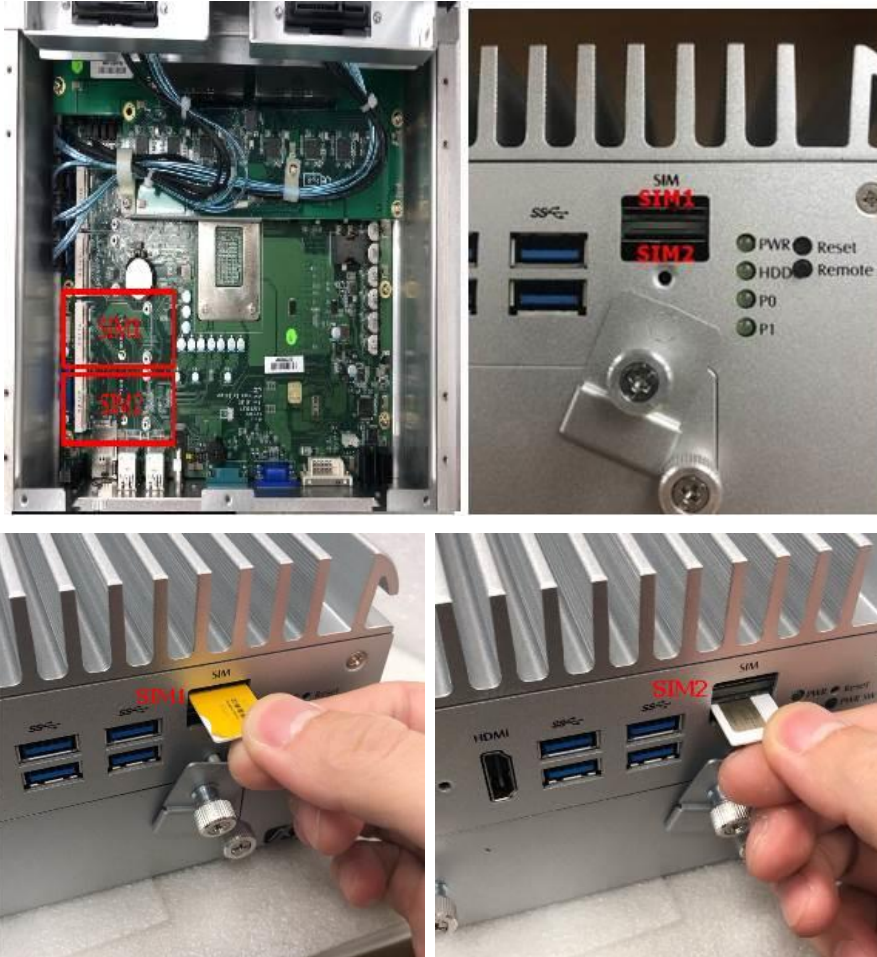

2.7.2 Installing 4G/3G Module for 2SATA

Step 1 Turn off the system and unplug the power cord.

Step 2 Turn the system upside down, and loosen the SATA tray.



Step 3 Loosen nine bottom cover screws as shown and open the cover carefully

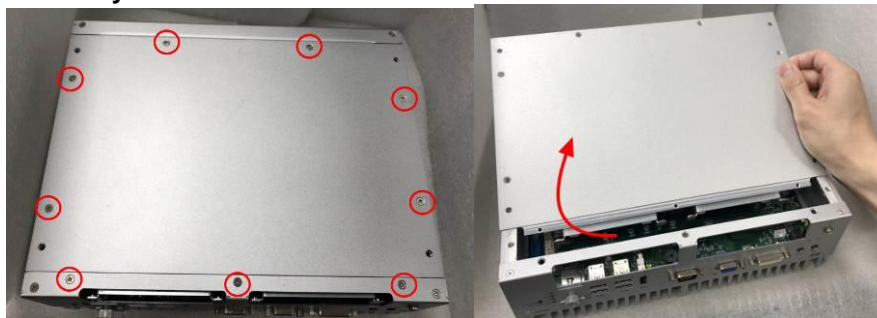

Step 4 Insert the wireless module (3G/4G/BT/GPS module etc.) into the slot with the marking "PCIe / USB".

Step 5 For instance, insert the 3G module and screw it tight.

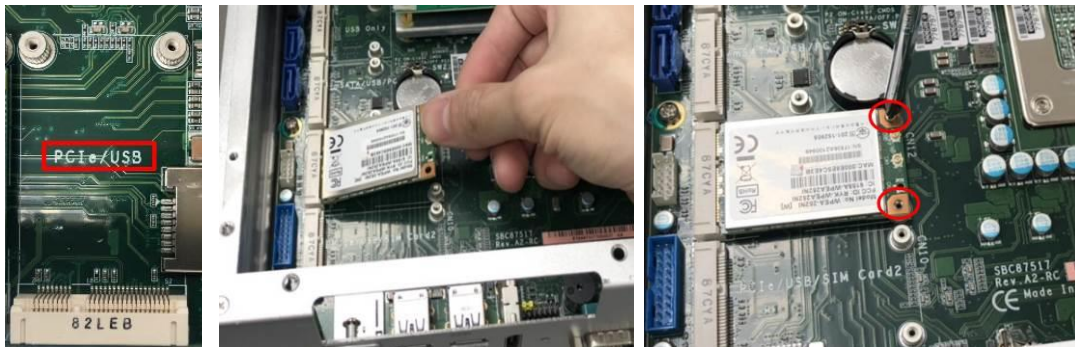

Step 6 Remove the black plastic antenna plug cover from the rear panel.

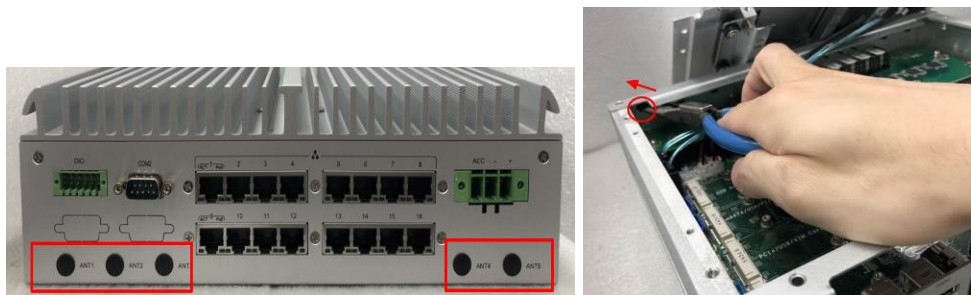

Step 7 Connect the RF cable to the connector of the 3G module with the marking "MAIN" .



Step 8 Place the larger plastic spacer over the other end of the RF cable (Figure 1 left) (Figure 2) and then insert the RF cable through the antenna hole (Figure 3).



(Figure 1)



(Figure 2)

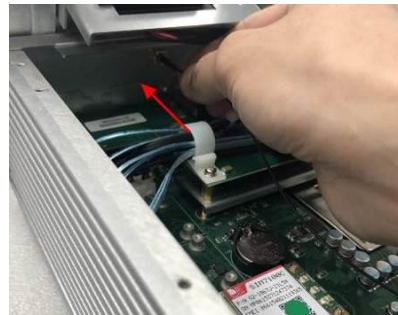

(Figure 3)

Step 9 Place the smaller plastic spacer over the end of the RF cable (Figure 1 right & Figure 5) and screw it firmly with the washer (Figure 4 right & Figure 6), and then the nut (Figure 4 left & Figure 7).



(Figure 4)



(Figure 5)



(Figure 6)



(Figure 7)

Step 10 Put the cover back onto the system, and fasten nine bottom screws firmly.

Step 11 Slide and secure SATA trays back.



Step 12 Place the system upright, and then screw the RF antenna firmly.



Step 13 Loosen the SIM cover screw and insert the SIM card.



【Note】 The system provides two PCIe slots for SIM card installation. Pay attention to the orientation when inserting a SIM card: The SIM card's contacts must face downward when the card is being inserted into the SIM1 slot; the card's contacts must face upward when it is being inserted into the SIM2 slot.

2.7.3 Installing 4G/3G Module for No Tray

Step 1 Turn off the system and unplug the power cord.

Step 2 Flip over the system, and loosen the cover screws.

Step 3 Open the cover carefully and unplug the SATA cable.



Step 4 Insert the wireless module (3G/4G/BT/GPS module etc.) into the slot with the marking "PCIe / USB". Then fasten the screws as shown.



Step 5 Remove the black plastic antenna plug cover from the rear panel.



Step 6 Connect the RF cable to the connector of the 3G module marked with "MAIN".



Step 7 Make the end of the RF cable go through the hole of the larger RF gasket .

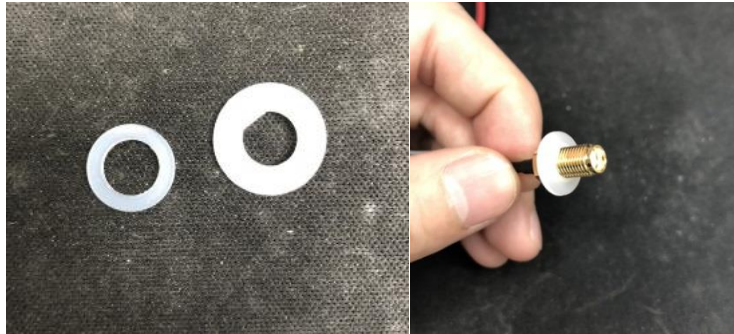

Step 8 Take out the fastening nuts from the 4G/3G kit package (Figure 1). Insert the end of the RF cable through the antenna hole (Figure 2 and 3). Place the smaller gasket and screw it tight (Figure 4) with the fastening nuts.



(Figure 1)



(Figure 2)

(Figure 3)

(Figure 4)

Step 9 Put the cover back and plug the SATA cable.

Step 10 Fasten all cover screws tight to complete the installation.



Step 11 Flip over the system, and screw the RF antenna tight.



Step12 Loosen the screw to remove the SIM cover and insert the SIM card.



2.8 Installing the Wall Mount Kit

2.8.1 Installing the Wall Mount Kit for 2SATA/4SATA

- Step 1 Turn off the system and unplug the power cord.
- Step 2 Turn the system upside down to locate four screw holes reserved for the wall mount at the bottom.
- Step 3 Take the wall mount with the high side facing up and fasten the screws tightly as below shown to complete the installation.

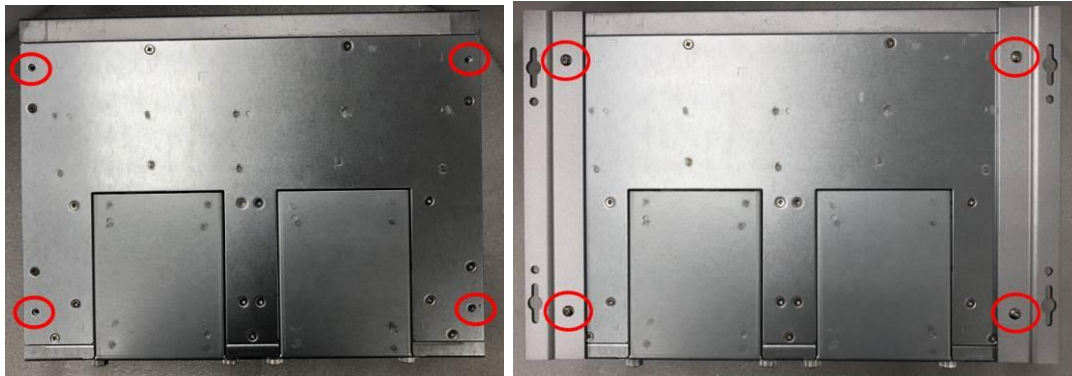

2.8.2 Installing the Wall Mount Kit for No Tray

- Step 1 Turn off the system and unplug the power cord.
- Step 2 Locate the wall mount screw holes on both sides of the system.
- Step 3 Attach the wall mount to the system and fasten the screws tightly as shown below to complete the installation.



2.9 Installing the Cable Fixing Plate

2.9.1 Installing the HDMI Cable Fixing Plate

- Step 1** Turn off the system and unplug the power cord.
- Step 2** To fasten the HDMI cable fixing plate to the system, position the hole on the plate against the hole on the system, insert the screw into the holes, and turn the screw tightly to fasten the plate, as shown below.
- Step 3** Insert the HDMI cable into the system's HDMI port. Then Insert a cable tie through the loop of the cable fixing plate to bind the HDMI cable to the plate, as shown below.

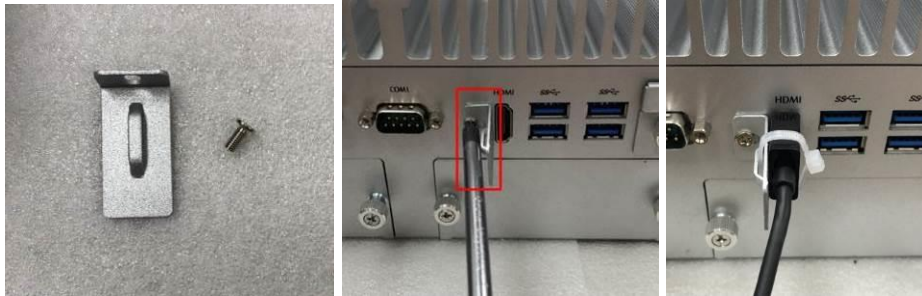

2.9.2 Audio Cable Installation

- Step 1** Turn off the system and unplug the power cord.
- Step 2** To fasten the audio cable fixing plate to the system, position the hole on the plate against the hole on the system, insert the screw into the holes, and turn the screw tightly to fasten the plate, as shown below.
- Step 3** Insert the audio cable into the system, and then use a cable tie to bind the audio cable together.



SECTION 3

DIP SWITCH, BUTTON & CONNECTOR SETTINGS

3.1 Summary of DIP Switch Settings

Proper DIP Switch settings configure the UST500-517-FL to meet various application purposes. The table below lists all jumpers and their default settings.

SW2 switch settings are indicated as below:

Switch	Descriptions	Settings	Mode
1	For CN15 mSATA / PCIe mode	ON	mSATA (Default)
		OFF	PCIe
2	Restore BIOS Optimal	ON	Restore
		OFF	Normal (Default)

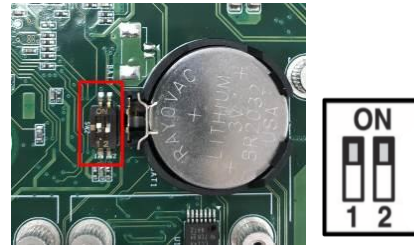

SW3 switch settings are indicated as below:

Switch1	Switch2	Descriptions
ON	OFF	AT mode : 9~36VDC AT mode (Note)
OFF	OFF	In-Vehicle mode : (Default) Auto detect 12 / 24VDC input with Ignition control



[Note] UST500-517-FL can support 9~36VDC AT Mode Power Function (waived ACC power connection and Ignition function).

3.2 Buttons

3.2.1 Power Button

The power button is located on the I/O side. It allows users to control power on/off state of the UST500-517-FL.



Note: Refer to APPENDIX D for instructions on Power button settings for Windows.

Functions	Descriptions
On	Turn on/off system
Off	Keep system status



3.2.2 Reset Button

The reset button allows users to reset UST500-517-FL.

Functions	Descriptions
On	Reset system
Off	Keep system status



3.3 Connectors

Please refer to pin assignments below:

3.3.1 DC-in Power Connector

The system supports the 9~36V (Default 12/24V) DC-in connector for system power input. Use a 16AWG power wire for the system that consumes up to 150w.

Pins	Signals
1	DC+
2	GND
3	ACC (Accessory Power)

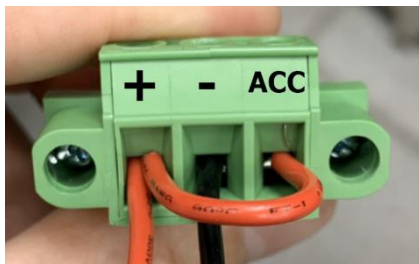
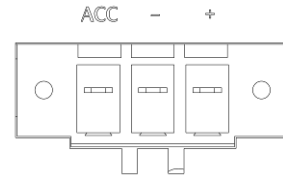

(Figure 1)



(Figure 2)



[Note] Connect the DC-in power connector for the UST500-517-FL in-vehicle system as follows:

1. When using in-Vehicle applications, connect the ACC pin to the accessory power of the vehicle.

If the testing environment is not able to provide accessory power, refer to the connection method illustrated in Figure 1 to proceed.

※**Note:** If the ACC action behavior is incorrect and causes the system to shut down abnormally, please ensure the correct wiring method for the ACC connection when setting up the vehicle layout. Connecting it to the DC input may lead to incorrect ignition configuration actions.

There are multiple connection methods available to effectively control the UST500 ignition configuration for proper operation. For instance, you can connect it to the ACC (Accessories power switch) in the vehicle, use a separate switch, or trigger it using GPIO actions. Furthermore, software configuration is required, and detailed instructions can be found in Chapter 4.4 on Ignition Configuration and Appendix D.

2. When the AT mode is in use, refer to the SW3 switch mode in section 3.1, and leave the power connector's ACC pin open, as illustrated in Figure 2.

3.3.2 HDMI Connector

The HDMI Rev1.4b (High-Definition Multimedia Interface) is a compact digital interface which is capable of transmitting high-definition video and high-resolution audio over a single cable. Pin definition follows **HDMI Type A standard**.

3.3.3 DVI-D Connector

Pin definition follows **DVI-D (dual link) standard**.

3.3.4 VGA Connector

Pin definition follows **Video Electronics Standards Association (VESA)**.



【Note】 While using HDMI as a main monitor and VGA as a secondary monitor in

dual monitors scenario, use keyboard presses  +  or  to move “Graphics control panel settings” in the main monitor in order to set the priorities of monitors.

3.3.5 Serial Port Connector(COM1~COM2)

The UST500-517-FL has two serial ports. COM1~COM2 are RS-232/422/485 ports. Please refer to Chapter 4 for detailed BIOS settings.

Pins	RS-232	RS-422	RS-485
1	DCD, Data carrier detect	TX-	Data-
2	RXD, Receive data	TX+	Data+
3	TXD, Transmit data	RX+	NC
4	DTR, Data terminal ready	RX-	NC
5	GND, ground	GND, ground	GND, ground
6	DSR, Data set ready	NC	NC
7	RTS, Request to send	NC	NC
8	CTS, Clear to send	NC	NC
9	RI, Ring indicator	NC	NC

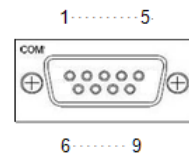

3.3.6 Ethernet & Power of Ethernet Connector (LAN1~LAN16)

RJ45

The functions of all RJ45 are described below:

Pins	LAN Signal	Pins	LAN Signal
1	MDI0+ (Passive V _{PSE+})	5	MDI2+ (Passive V _{PSE+})
2	MDI0- (Passive V _{PSE+})	6	MDI2- (Negative V _{PSE-})
3	MDI1+ (Negative V _{PSE-})	7	MDI3+ (Negative V _{PSE-})
4	MDI1- (Passive V _{PSE+})	8	MDI3- (Negative V _{PSE-})
ACT	Activity link LED (Orange) OFF: No link Blinking: Link established; data activity detected		
PoE	PoE LED Green: PoE power activity LED Blinking: over power budget		

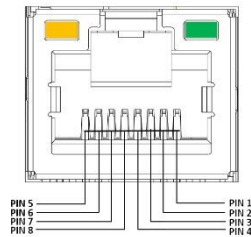

M12 (A Code)

The functions of all M12 are described below:

Pins	LAN Signal	Pins	LAN Signal
1	MDI2+ (Passive V _{PSE+})	5	MDI1+ (Passive V _{PSE+})
2	MDI3+ (Passive V _{PSE+})	6	MDI0+ (Negative V _{PSE-})
3	MDI3- (Negative V _{PSE-})	7	MDI2- (Negative V _{PSE-})
4	MDI0- (Passive V _{PSE+})	8	MDI1- (Negative V _{PSE-})
ACT	Activity link LED(Orange) OFF: No link Blinking: Link established; data activity detected		
PoE	PoE LED Green: PoE power activity LED Blinking: over power budget		

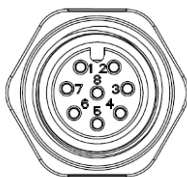

NOTE: If PoE power supply exceeds power budget and the PoE LED will start blinking.

3.3.7 USB 3.0 Connector

The Universal Serial Bus connectors are compliant with USB 3.0 (5 GB/s), ideal for connecting USB peripherals such as scanners, cameras and other USB devices. Pin definition follows **USB Implementers Forum, Inc.**

3.3.8 Audio Connector

These two 3.5mm audio jacks are ideal for connecting **TRS** stereo plugs for Audio Mic-In and Audio Line-out.

Pins	Signals
1	Microphone In
2	Line Out

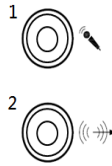

3.3.9 Digital I/O

The UST500-517-FL supports 6CH isolated digital inputs and 2CH isolated digital outputs.

Pins	Signals	Pins	Signals
1	COM+	7	IN 0
2	OUT0	8	IN 1
3	OUT1	9	IN 2
4	COM-	10	IN 3
5	DIO_GND	11	IN 4
6	Ext Power	12	IN 5

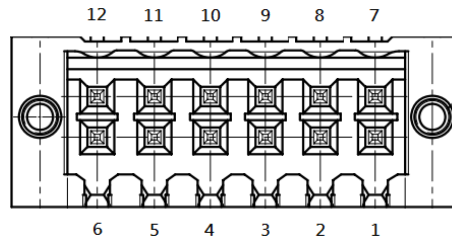

NOTE: Please refer to Appendix B for more information about Digital I/O

3.3.10 SATA Connector (SATA 1~4)

These Serial Advanced Technology Attachment (Serial ATA or SATA) connectors support high-speed SATA interfaces. They are computer bus interfaces for connecting to devices such as hard disk drives. This board has two **SATA 3.0** ports at the rate of up to 6Gb/s. Pin definition follows **Serial ATA International Organization**.

3.3.11 SATA Power Connector

The table shows all SATA power connector pin out:

Pins	Signals
1	+5V level
2	GND



3.3.12 SIM Card Slots (S1~S2)

The UST500-517-FL includes one SIM slot on the front side of the system for inserting a SIM Card. It is mainly used for 3G/4G/LTE wireless network applications on CN10 and CN12. PIN definition follows ISO/IEC 7810:2003, ID-000.

3.3.13 PCI Express Mini Card Slot

Full-Size (CN10 & CN12)

The UST500-517-FL supports dual full-size PCI-Express Mini Card slots. CN10 and CN12 apply to either **PCI-Express2.0** or **USB 2.0** signals, and follow up **PCI-Express Mini Card Spec. V1.2**.

The table shows the Mini Card pins define:

Pin s	Signals	Pin s	Signals
51	NC	52	+3.3Vaux
49	NC	50	GND
47	NC	48	+1.5V
45	NC	46	NC
43	GND	44	NC
41	+3.3Vaux	42	NC
39	+3.3Vaux	40	GND
37	GND	38	USB_D+
35	GND	36	USB_D-
33	PETp	34	GND
31	PETn	32	SMB_DATA
29	GND	30	SMB_CLK
27	GND	28	+1.5V
25	PERp	26	GND
23	PERn	24	+3.3Vaux
21	GND	22	PERST#
19	NC	20	W_DISABLE#
17	NC	18	GND
Mechanical Key			
15	GND	16	UIM_VPP
13	REFCLK+	14	UIM_RESET
11	REFCLK-	12	UIM_CLK
9	GND	10	UIM_DATA
7	NC	8	UIM_PWR
5	NC	6	1.5V
3	NC	4	GND
1	WAKE#	2	3.3Vaux

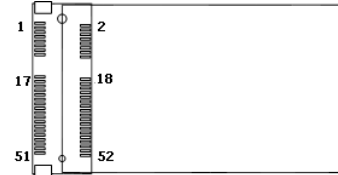

Half-Size (CN15 & CN16)

CN15 applies to **PCI-Express2.0, USB2.0** and **SATA (mSATA)** signals and complies with **PCI-Express Mini Card Spec. V1.2**. Thus, users can install an mSATA card into this slot. Please refer to section 3.1 DIP Switch Mode.

CN16 only applies to USB 2.0 signals and follow up **PCI-Express Mini Card Spec. V1.2**.

The table shows the Mini Card pins define:

Pin s	Signals	Pin s	Signals
51	NC	52	+3.3Vaux
49	NC	50	GND
47	NC	48	+1.5V
45	NC	46	NC
43	GND	44	NC
41	+3.3Vaux	42	NC
39	+3.3Vaux	40	GND
37	GND	38	USB_D+
35	GND	36	USB_D-
33	PETp mSATA_Tp	34	GND
31	PETn mSATA_Tn	32	SMB_DATA
29	GND	30	SMB_CLK
27	GND	28	+1.5V
25	PERp mSATA_Rp	26	GND
23	PERn mSATA_Rn	24	+3.3Vaux
21	GND	22	PERST#
19	NC	20	W_DISABLE#
17	NC	18	GND
Mechanical Key			
15	GND	16	NC
13	REFCLK+	14	NC
11	REFCLK-	12	NC
9	GND	10	NC
7	NC	8	NC
5	NC	6	1.5V
3	NC	4	GND
1	WAKE#	2	3.3Vaux

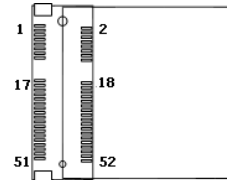

This page is intentionally left blank.

SECTION 4 BIOS SETUP UTILITY

This section provides users with detailed descriptions in terms of how to set up basic system configurations through the BIOS setup utility.

4.1 Starting

To enter the setup screens, follow the steps below:

1. Turn on the computer and press the key immediately.
2. After press the key, the main BIOS setup menu displays. Users can access to other setup screens, such as the Advanced and Chipset menus, from the main BIOS setup menu.

It is strongly recommended that users should avoid changing the chipset's defaults. Both AMI and system manufacturer have carefully set up these defaults that provide the best performance and reliability.

4.2 Navigation Keys

The BIOS setup/utility uses a key-based navigation system called hot keys. Most of the BIOS setup utility hot keys can be used at any time during the setup navigation process. These keys include <F1>, <F2>, <Enter>, <ESC>, <Arrow> keys, and so on.



【Note】 : *Some of the navigation keys differ from one screen to another.*

Hot Keys	Descriptions
→← Left/Right	The Left and Right <Arrow> keys allow users to select a setup screen.
↑↓ Up/Down	The Up and Down <Arrow> keys allow users to select a setup screen or sub-screen.
+– Plus/Minus	The Plus and Minus <Arrow> keys allow users to change the field value of a particular setup item.
Tab	The <Tab> key allows users to select setup fields.
F1	The <F1> key allows users to display the General Help screen.
F2	The <F2> key allows users to Load Previous Values.
F3	The <F3> key allows users to Load Optimized Defaults.
F4	The <F4> key allows users to save any changes they made and exit the Setup. Press the <F4> key to save any changes.
Esc	The <Esc> key allows users to discard any changes they made and exit the Setup. Press the <Esc> key to exit the setup without saving any changes.
Enter	The <Enter> key allows users to display or change the setup option listed for a particular setup item. The <Enter> key can also allow users to display the setup sub- screens.

4.3 Main Menu

The Main Menu screen is the first screen users see when entering the setup utility. Users can always return to the Main setup screen by selecting the Main tab. System Time/Date can be set up as described below. The Main BIOS setup screen is also shown below.



BIOS Information

Display the auto-detected BIOS information.

System Language

Choose the system default language.

System Date/Time

Use this option to change the system time and date. Highlight System Time or System Date using the <Arrow> keys. Enter new values through the keyboard. Press the <Tab> key or the <Arrow> keys to move between fields. The date must be entered in MM/DD/YY format. The time is entered in HH:MM:SS format.

Access Level

Display the access level of the current user.

4.4 Advanced Menu

The Advanced menu also allows users to set configuration of the CPU and other system devices. Users can select any items in the left frame of the screen to go to sub menus:

- ▶ CPU Configuration
- ▶ NCT6106D Super IO Configuration
- ▶ NCT6106D HW Monitor
- ▶ SATA Configuration
- ▶ PCH-FW Configuration
- ▶ USB Configuration
- ▶ Utility Configuration
- ▶ NCT6106D DIO Configuration
- ▶ Ignition Configuration
- ▶ PoE Configuration

For items marked with “▶”, please press <Enter> for more options.

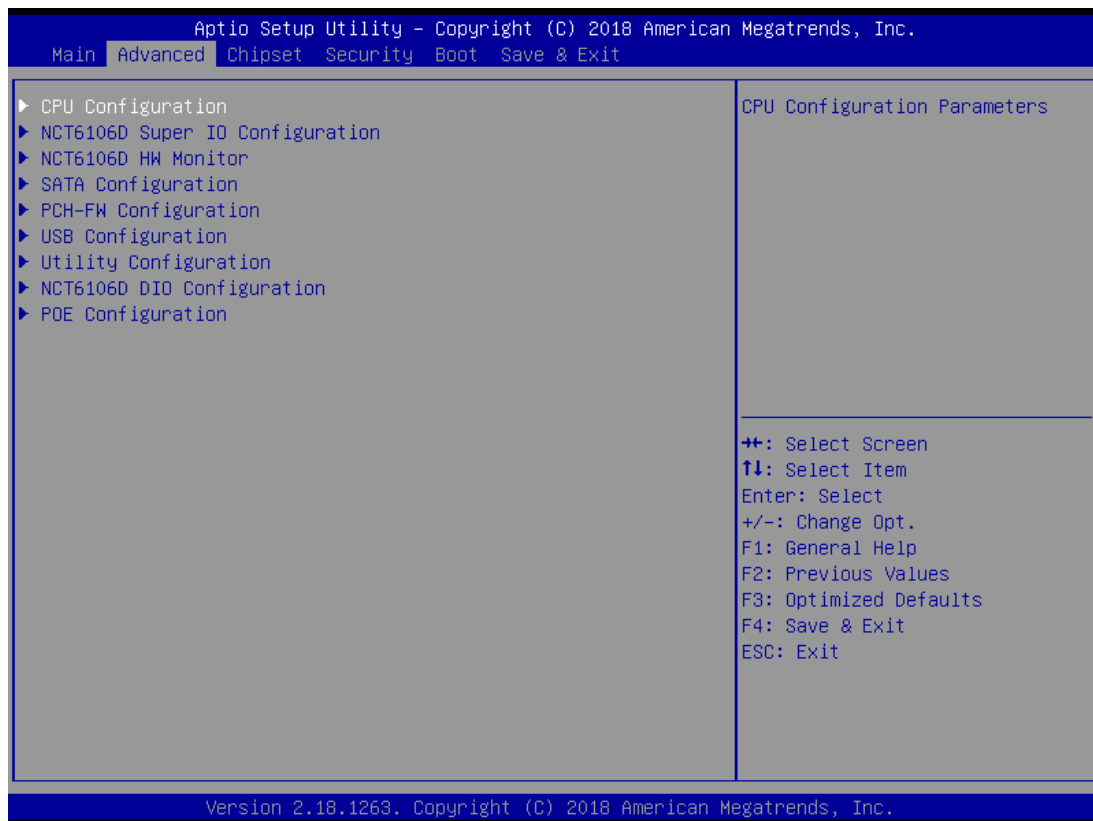

CPU Configuration

This screen shows the CPU version and its detailed information.

CPU Configuration		Enabled for Windows XP and Linux (OS optimized for Hyper-Threading Technology) and Disabled for other OS (OS not optimized for Hyper-Threading Technology).
Type	Intel(R) Core(TM) i7-6700TE CPU @ 2.40GHz	
ID	0x506E3	
Microcode Revision	C2	
Speed	2400 MHz	
L1 Data Cache	32 KB x 4	
L1 Instruction Cache	32 KB x 4	
L2 Cache	256 KB x 4	
L3 Cache	8 MB	
L4 Cache	N/A	
VMX	Supported	
SMX/TXT	Supported	
Hyper-Threading	[Enabled]	** : Select Screen ↑↓ : Select Item Enter : Select +/- : Change Opt. F1 : General Help F2 : Previous Values F3 : Optimized Defaults F4 : Save & Exit ESC : Exit
Intel (VMX) Virtualization Technology	[Enabled]	

Intel Virtualization Technology

It allows a hardware platform to run multiple operating systems separately and simultaneously, enabling one system to virtually function as several systems.

NCT6106D Super IO Configuration

Use this screen to select options for the NCT6106D Super IO Configurations, and change the value of the selected option. A description of the selected item appears on the right side of the screen. For items marked with a right-pointing arrow (▶) on the screen. For items marked with a left-pointing arrow (◀) on the screen.

The default setting for all Serial Ports is RS232.

You can change the setting by selecting the value you want in each COM Port Type. The system also supports RS422 & RS485 mode and high speed mode.



Serial Port 1~2 (COM1~2) Configurations

Use these items to set parameters related to serial ports 1~2.

Serial Port 1 Configuration

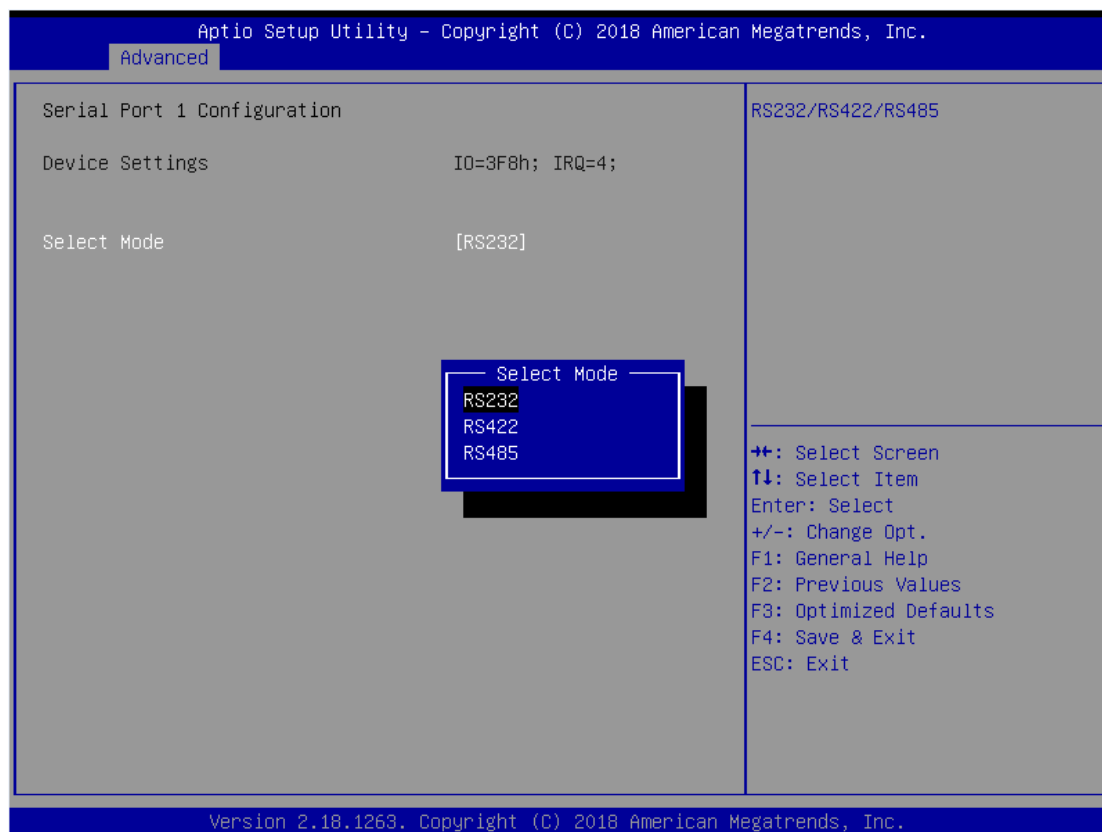

Select Mode

Use this option to set RS-232/RS-422/RS-485 mode.

Serial Port 2 Configuration

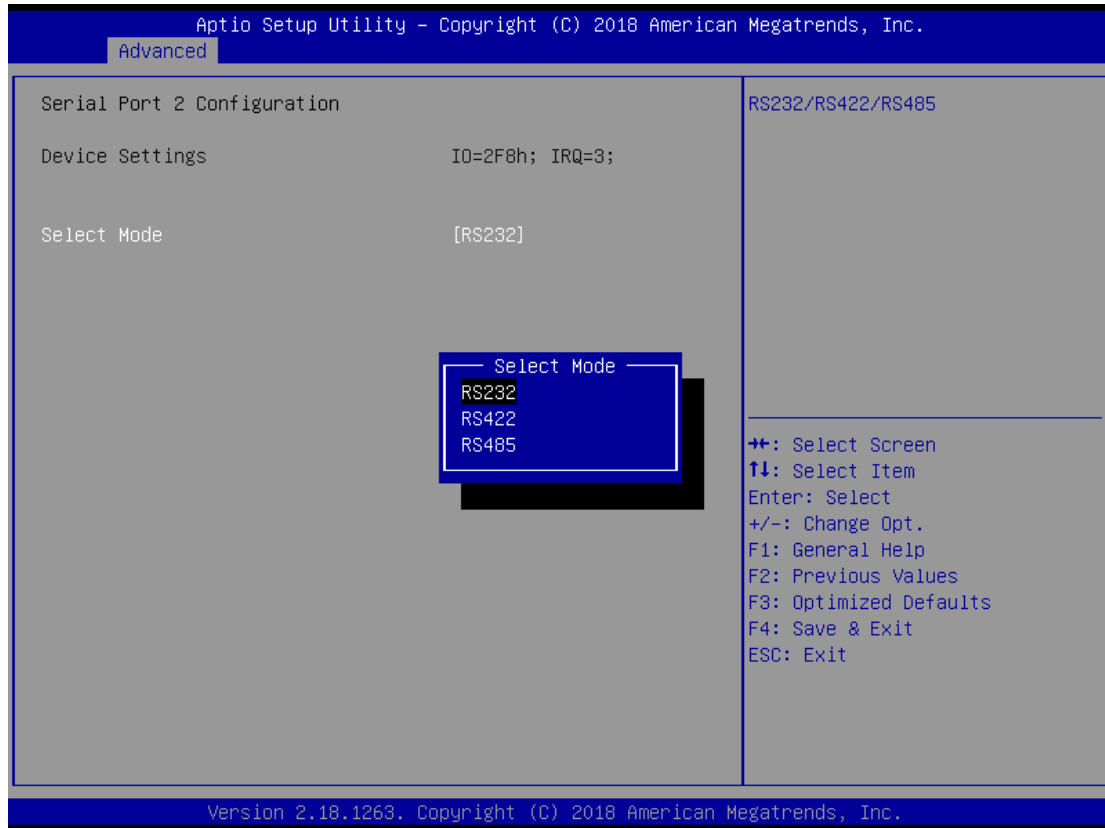

Aptio Setup Utility - Copyright (C) 2018 American Megatrends, Inc.

Advanced

Serial Port 2 Configuration RS232/RS422/RS485

Device Settings IO=2F8h; IRQ=3;

Select Mode [RS232]

Select Mode

- RS232
- RS422
- RS485

++: Select Screen
↑↓: Select Item
Enter: Select
+/-: Change Opt.
F1: General Help
F2: Previous Values
F3: Optimized Defaults
F4: Save & Exit
ESC: Exit

Version 2.18.1263. Copyright (C) 2018 American Megatrends, Inc.

NCT6106D Hardware Monitor

This screen displays the temperature of system and CPU and system voltages (V CORE, +3.3V, +12V and +5V).



SATA Configuration

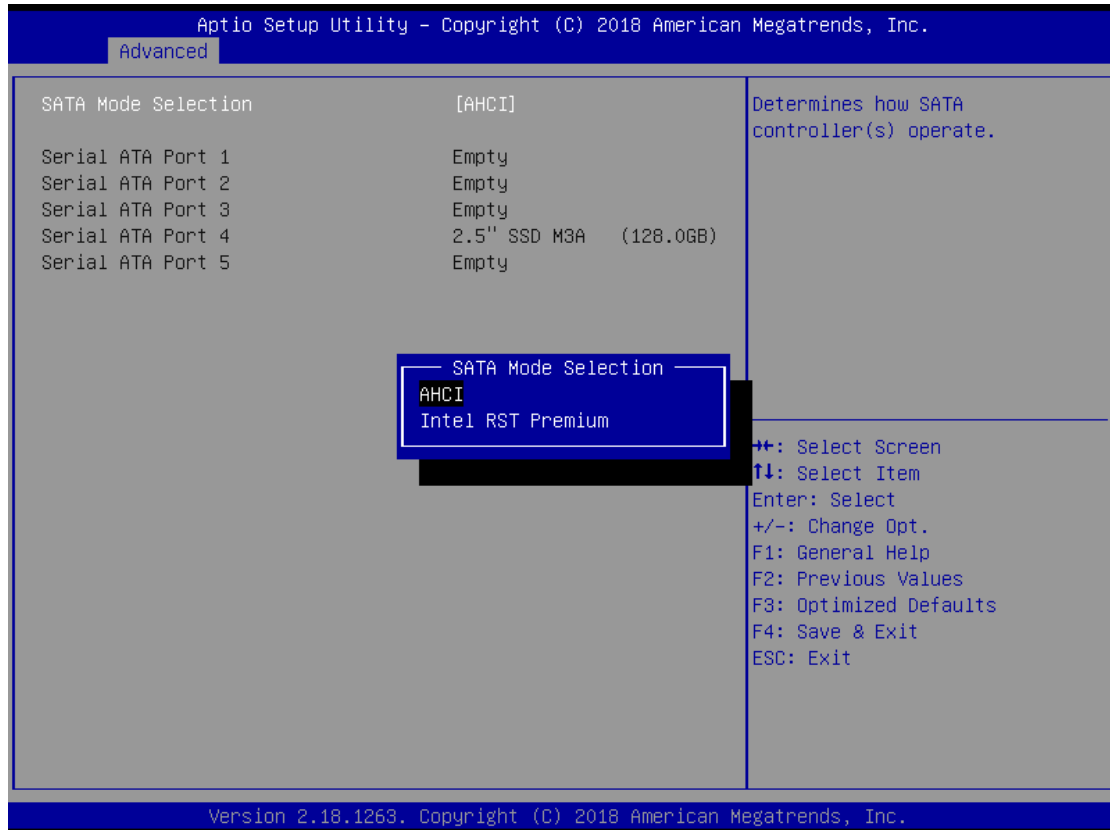

SATA Mode Selection

AHCI (Advanced Host Controller Interface) mode is how SATA controller(s) operate.

Serial ATA Port 0~5

It shows the device installed in connector SATA0~5.

PCH-FW Configuration

This screen shows ME Firmware information.



USB Configuration

This screen specifies USB settings.

Aptio Setup Utility - Copyright (C) 2018 American Megatrends, Inc.

Advanced

USB Configuration USB Module Version 17 USB Controllers: 1 XHCI USB Devices: 1 Drive, 1 Keyboard, 1 Mouse, 1 Hub Mass Storage Devices: USB 2.0 Flash Disk 0.00 [Auto]	Mass storage device emulation type. 'AUTO' enumerates devices according to their media format. Optical drives are emulated as 'CDROM', drives with no media will be emulated according to a drive type. ++: Select Screen ↑↓: Select Item Enter: Select +/-: Change Opt. F1: General Help F2: Previous Values F3: Optimized Defaults F4: Save & Exit ESC: Exit
--	---

Version 2.18.1263. Copyright (C) 2018 American Megatrends, Inc.

USB Devices

Display all detected USB devices.

Utility Configuration

BIOS flash utility is a tool for flashing BIOS on setup menu. Follow the steps to flash BIOS.

1. Create a folder and rename it to Axiomtek on the root of USB storage (Ex: X:\Axiomtek)
2. Copy the BIOS file to the Axiomtek folder (Ex: X:\Axiomtek\SBC87517V.103). (Note: The BIOS file name must contain the word SBC87517)
3. Enter the BIOS flash utility and locate the BIOS file.
4. Push "Start flash system BIOS".



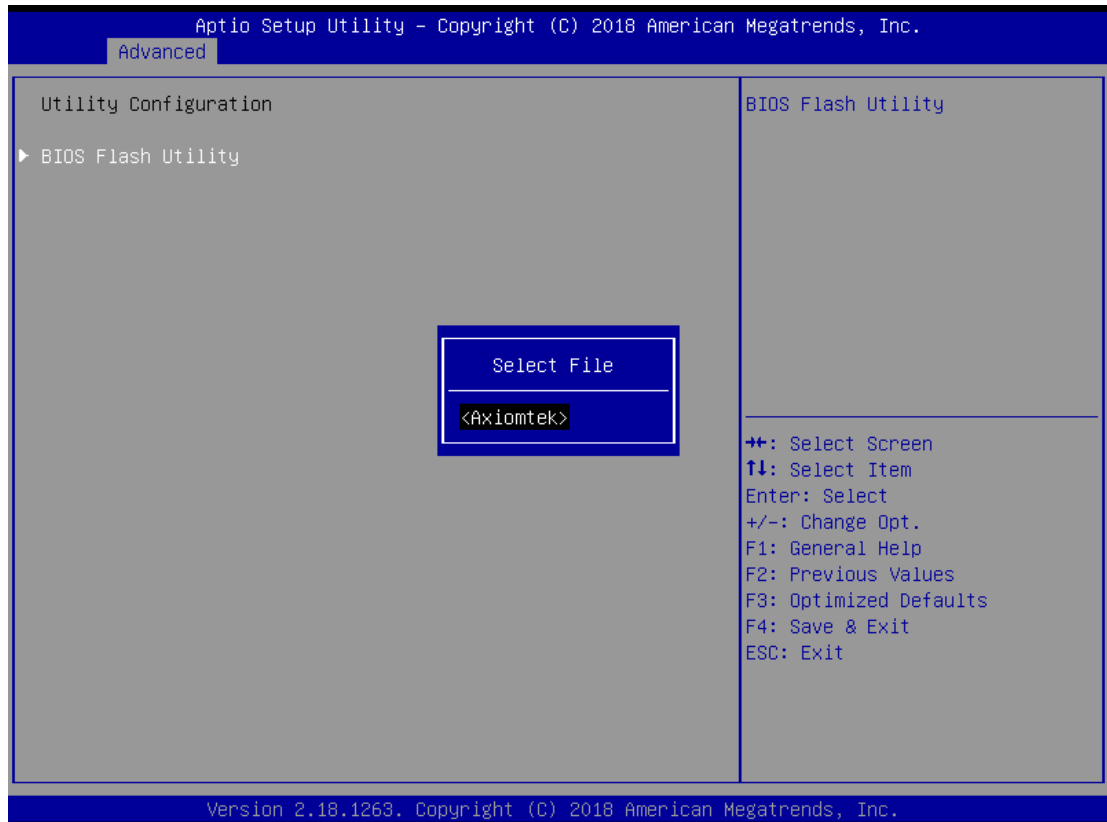
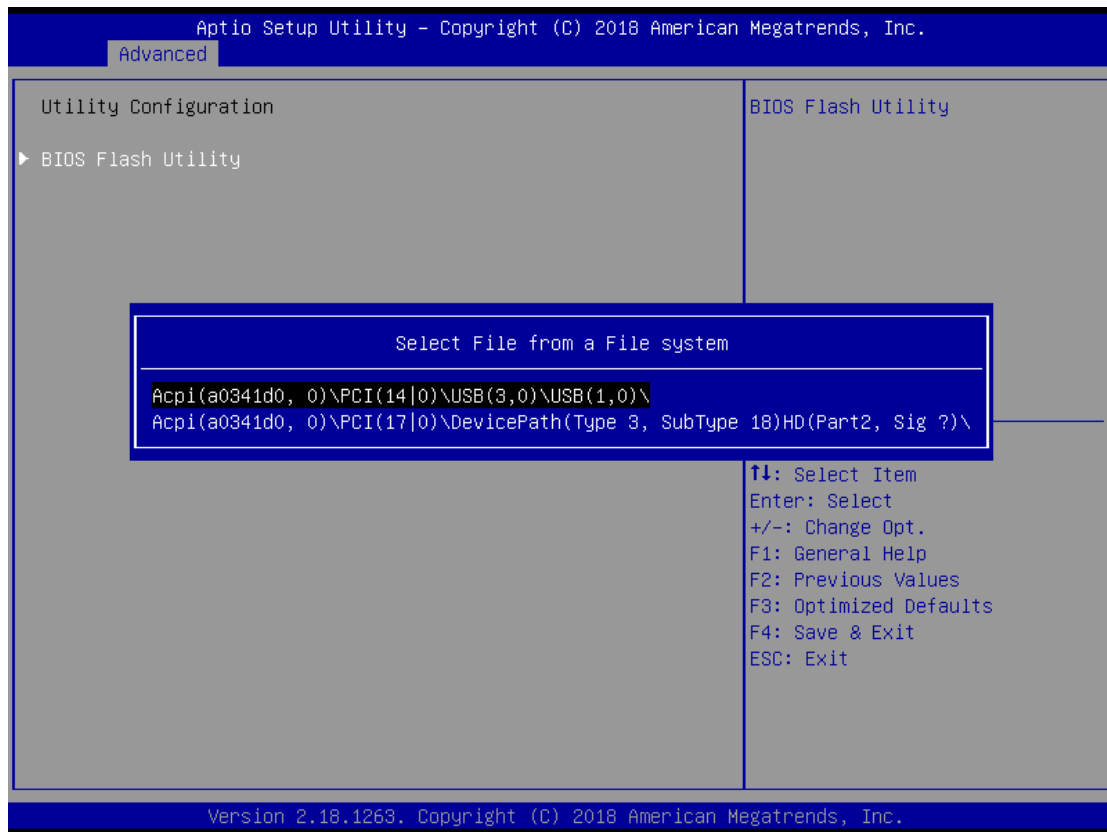

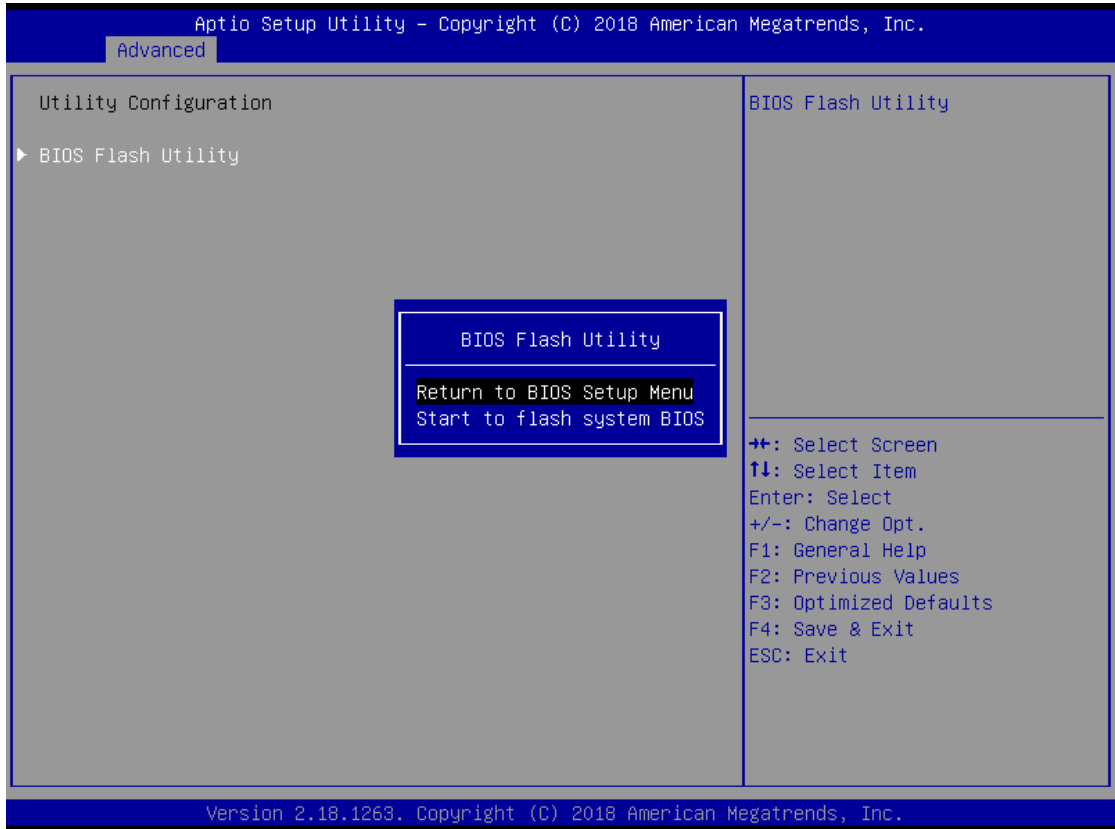
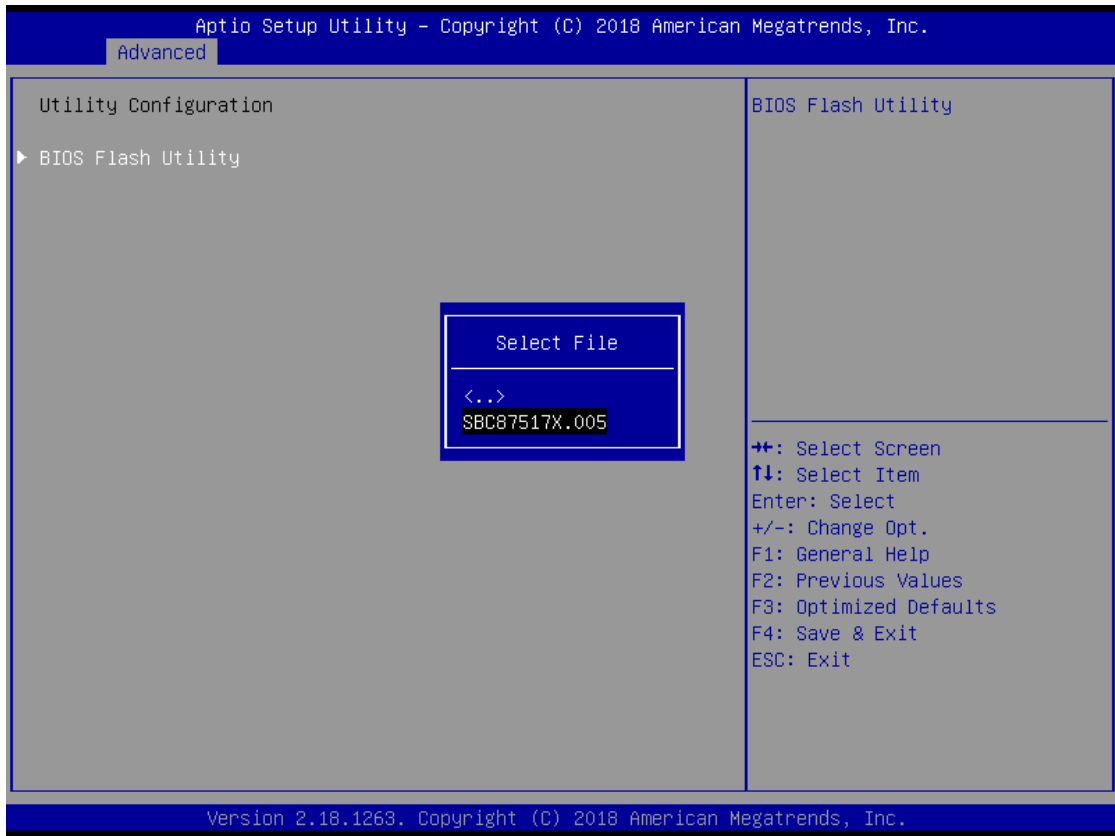

NCT6106D DIO Configuration

Use this screen to display DIO polarity and level.

Aptio Setup Utility - Copyright (C) 2019 American Megatrends, Inc.

Advanced

NCT6106D DIO Configuration	
DIO 0 Input/Output Status High/Low Setting	Output Low [Low]
DIO 1 Input/Output Status High/Low Setting	Output Low [Low]
DIO 2 Input/Output Status	Input High
DIO 3 Input/Output Status	Input High
DIO 4 Input/Output Status	Input High
DIO 5 Input/Output Status	Input High
DIO 6 Input/Output Status	Input High
DIO 7 Input/Output Status	Input High

++: Select Screen
 ↑↓: Select Item
 Enter: Select
 +/-: Change Opt.
 F1: General Help
 F2: Previous Values
 F3: Optimized Defaults
 F4: Save & Exit
 ESC: Exit

Version 2.18.1263. Copyright (C) 2019 American Megatrends, Inc.

Ignition Configuration

This menu allows users to configure settings related to vehicle ignition switch.



Note: Ignition related settings need to be used with the in-vehicle mode of Chapter 3.1 SW3.

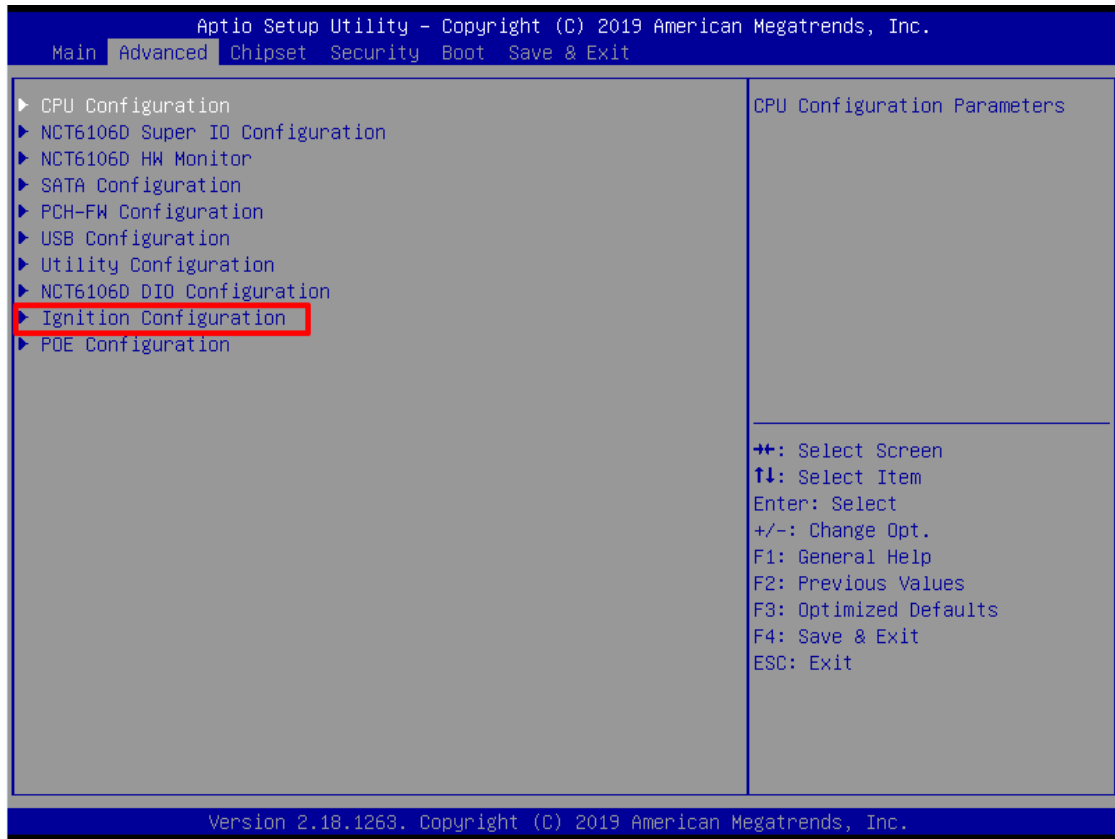

Use this screen to set ACC Timer.

- (1) ACC-ON Delay (T1): Set delay timer for system power on.
- (2) ACC-OFF Delay (T2): Set delay timer for system power off.
- (3) Shutdown Delay (T3): In case the system OS fails to shut down and gets stuck on the shutdown screen, setting time out will allow the system to force turn off system power.

Function	Specification range	Unit
ACC ON Delay (T1)	1~30	Sec
ACC OFF Delay (T2)	60~10800	Sec
Shutdown Delay (T3)	60~600	Sec

Advance Setting

This item shows all information and voltage settings.

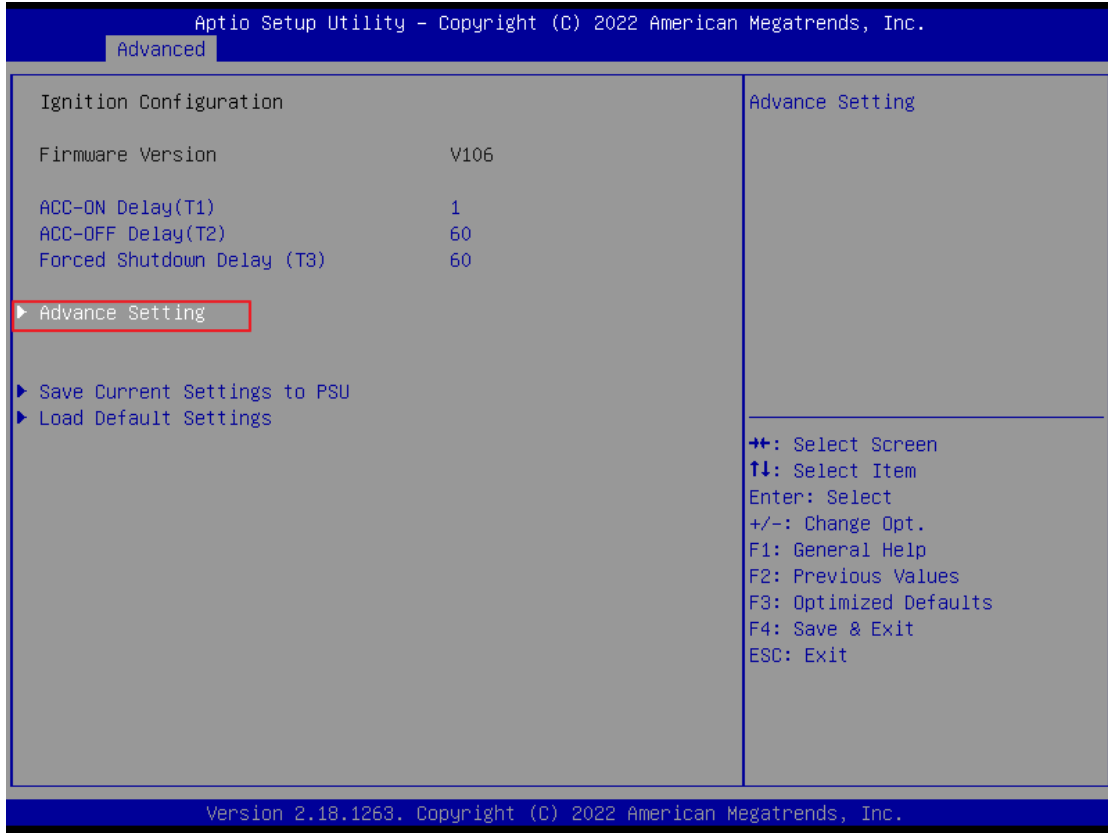

Voltage Setting

Voltage setting is designed to protect the lead-acid batteries and keep the system from running out of power when the lead-acid battery is low, so as not to drain the battery. (It is strongly recommended that users should avoid changing the defaults.)

- (1) Low Voltage: Notifies the system to shut down when voltage drops to the specified value.
- (2) Very Low Voltage: Force turns off system power when voltage drops to the specified value.

DC Mode	Function	Configuration range	Default Value	Unit
12V	Start Voltage	Low Voltage + 1V	10.5	V
	Low Voltage	9~12	9.5	
	Very Low Voltage	8.5~11.5	8.5	
24V	Start Voltage	Low Voltage + 2V	19.5	
	Low Voltage	17.5~24	17.5	
	Very Low Voltage	17~23.5	17	

Counter Setting

(3) Low Voltage Counter: Sets shut down delay time.

(4) Very Low Voltage Counter: Sets force turn off system power delay time.

Function	Spec range	Default Value	Unit
Low Voltage Counter	1~60	60	sec
Very Low Voltage Counter	1~120	120	sec

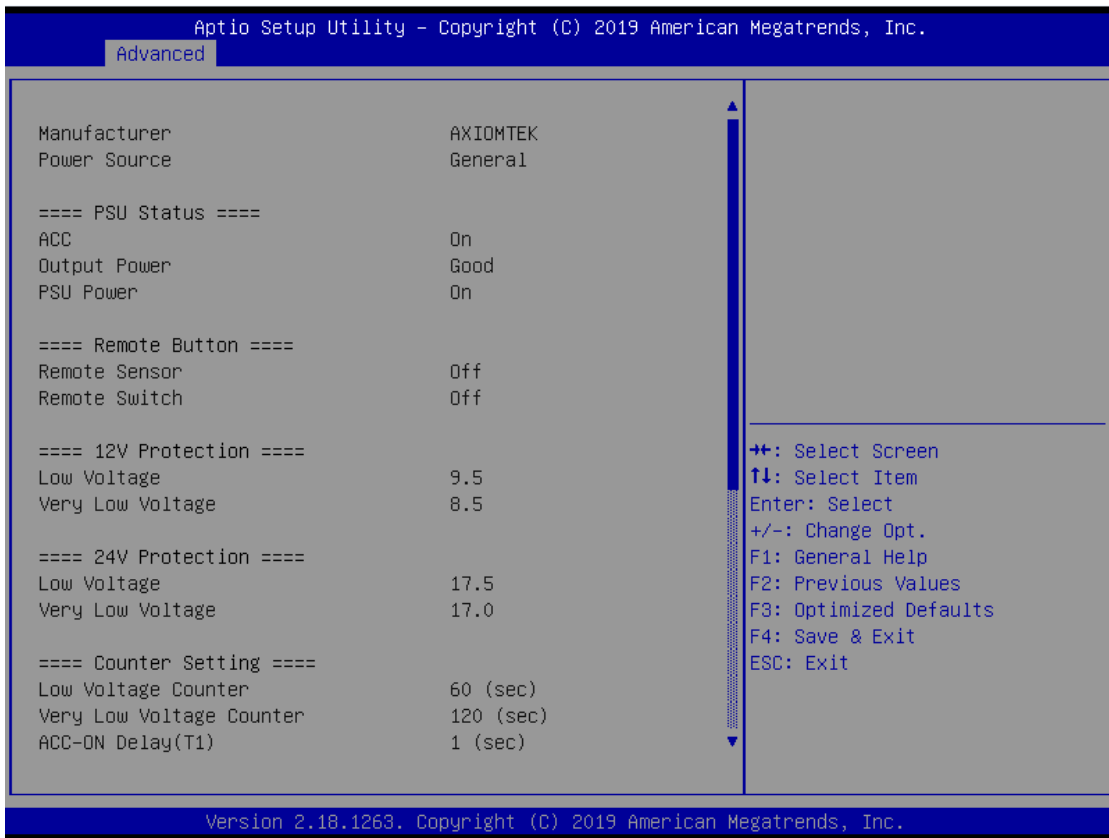

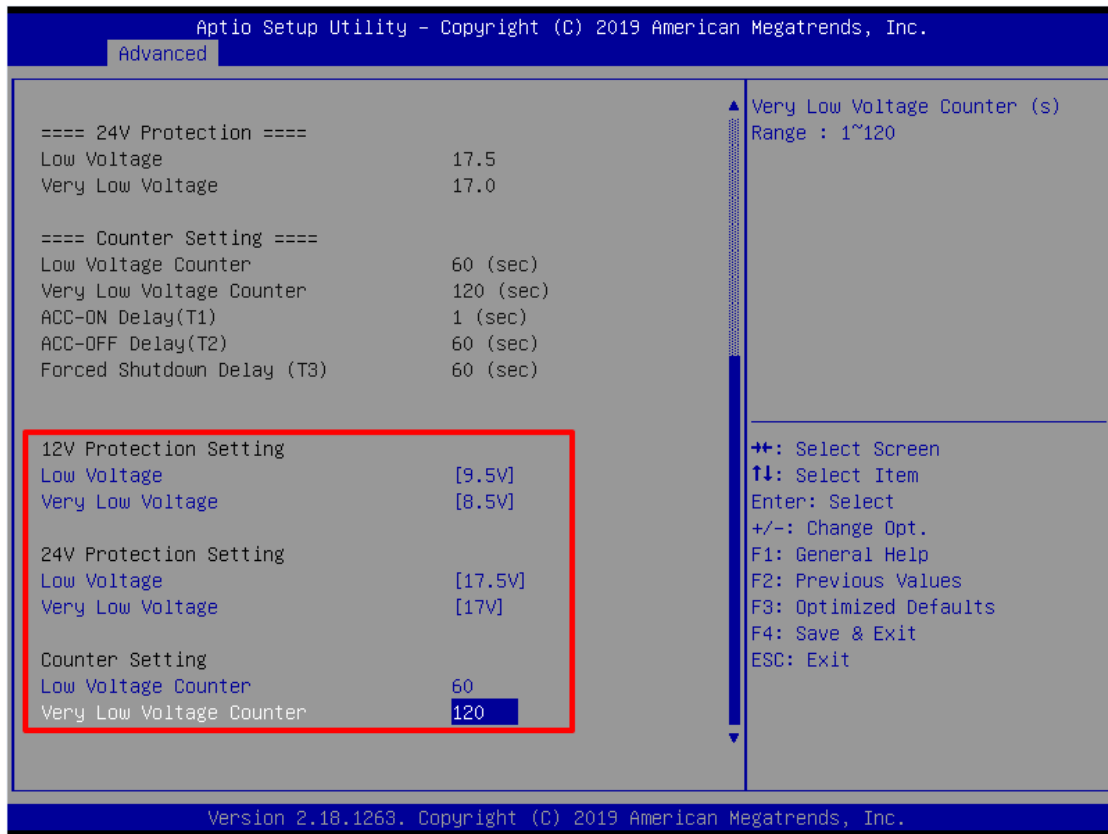

Save Setting

When all settings are completed, select "Save Current Setting to PSU" to save changes. If the user forgets to save current settings, the interface will pop up a notice message.

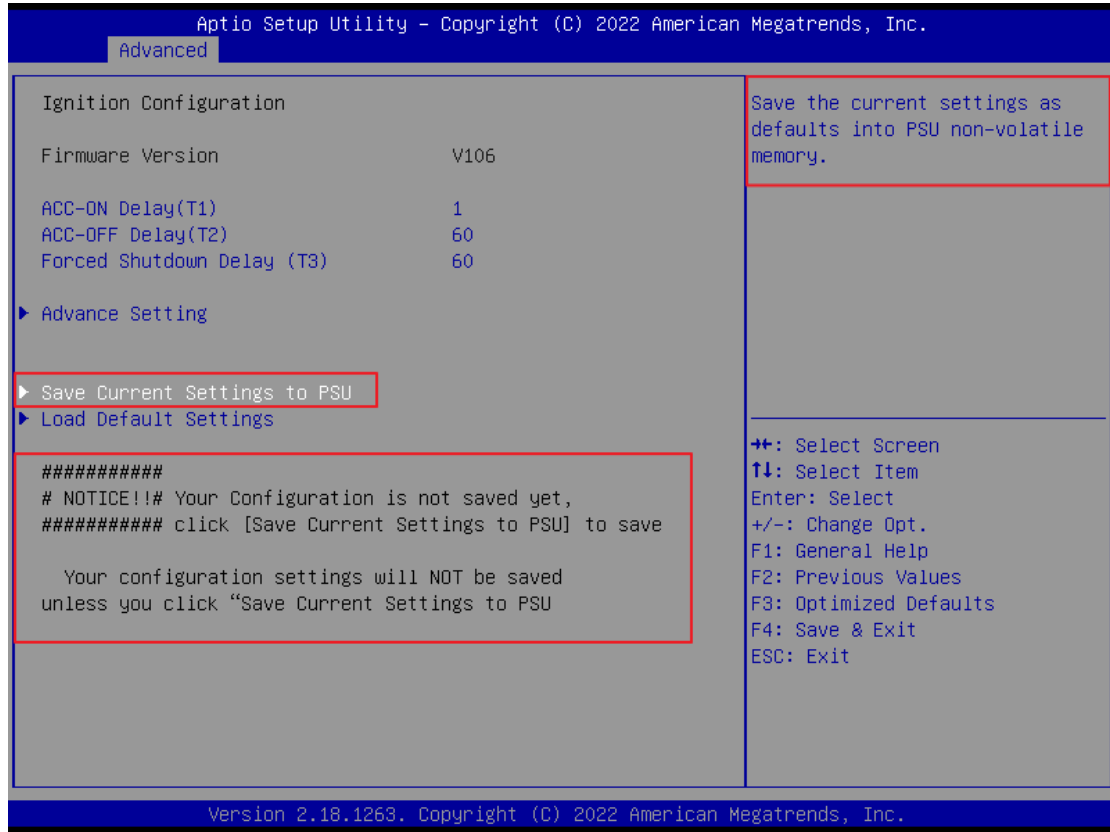

Load Default Setting

This option allows you to restore to default settings and save factory defaults.

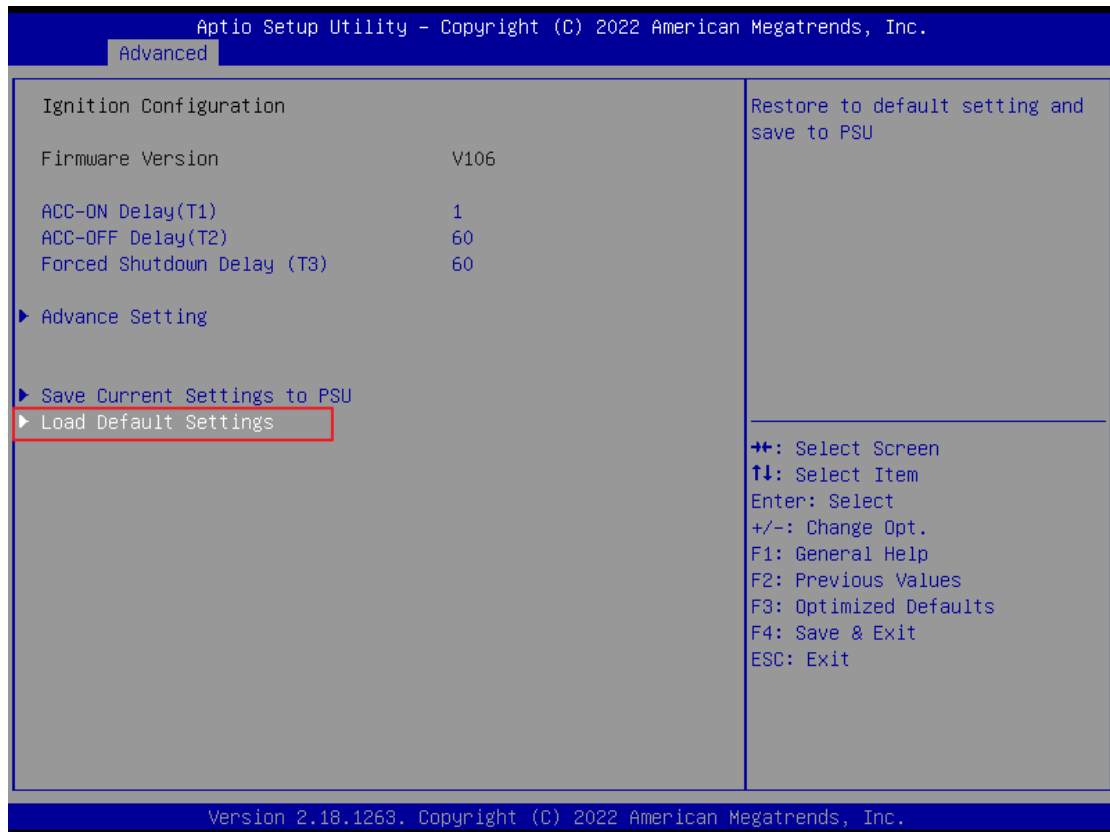

POE Configuration

Power over Ethernet (PoE) describes any of several standard or ad-hoc systems which pass electric power along with data on twisted pair Ethernet cabling.

This menu allows users to set the power and enable/disable a specific port.

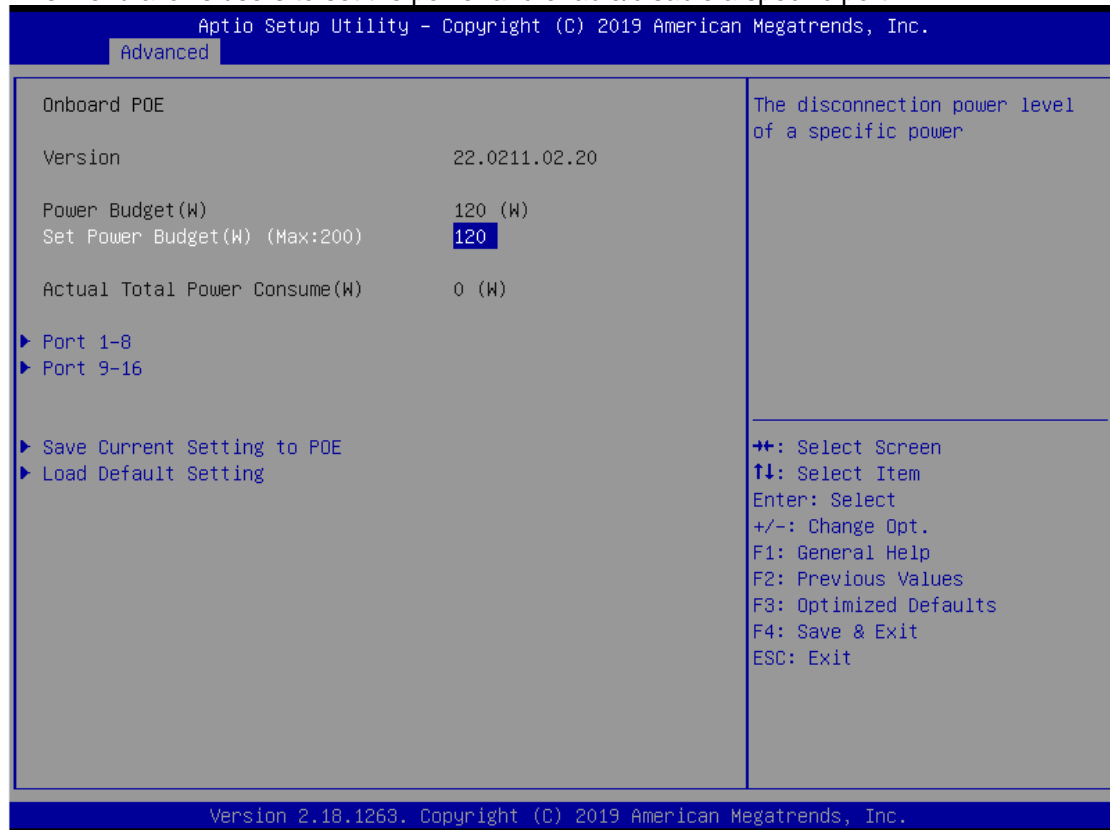

Version

Display PoE Controller FW version.

Power Budget

Display current total power budget on all ports.

 **Note:** Please be advised that the Power Budget must not smaller than the sum up of Power Device (PD) operating watts and Power Classifications Watts when setting up Power Budge. Otherwise, the system will not provide electricity to the PD. Please request the PD supplier for clear Power Classifications watts values or checking the info in the BIOS.

Set Power Budget

Set disconnection power level for a specific power (Max:200).

Actual Total Power Consume

The UST500-517-FL supplies power to devices according to actual power budget.

Save Current Setting to POE

Save the current settings from menu into the POE non-volatile memory and these user values become the defaults after any reset.

Load Default Setting

Restore to default settings and save to POE, Default : Power Budget 120w, all ports enabled.

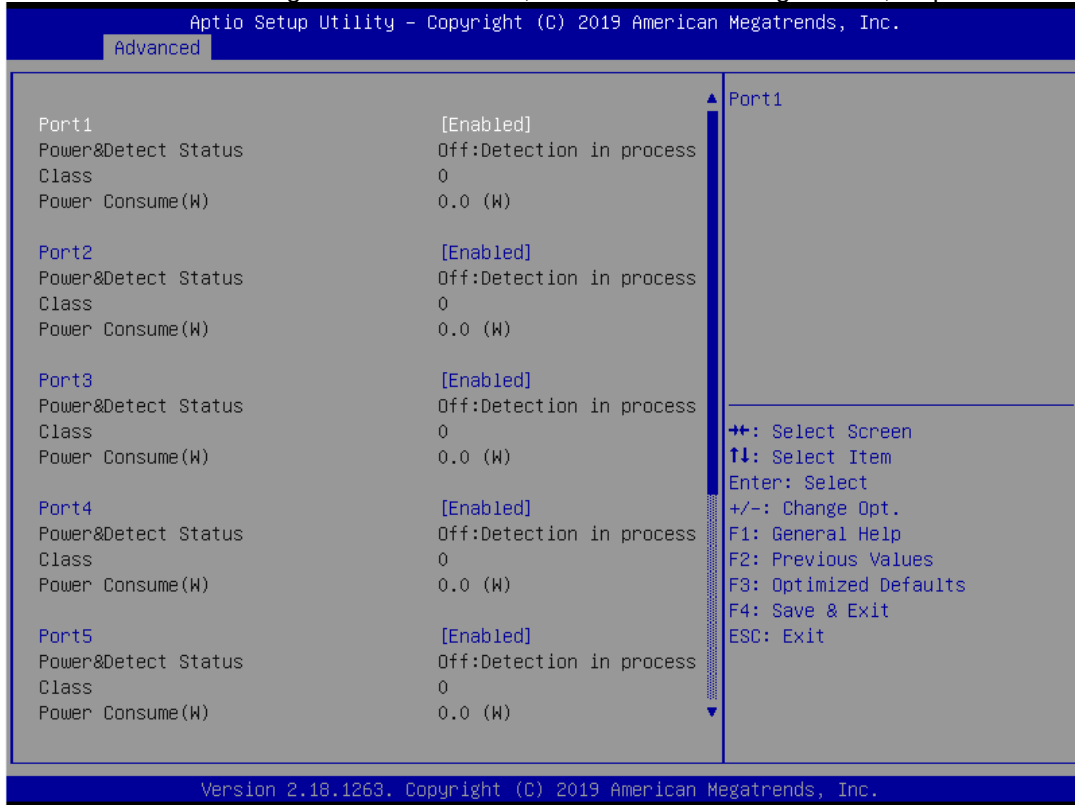

Port1~Port8

Enable/Disable a specific POE port and display all port status.

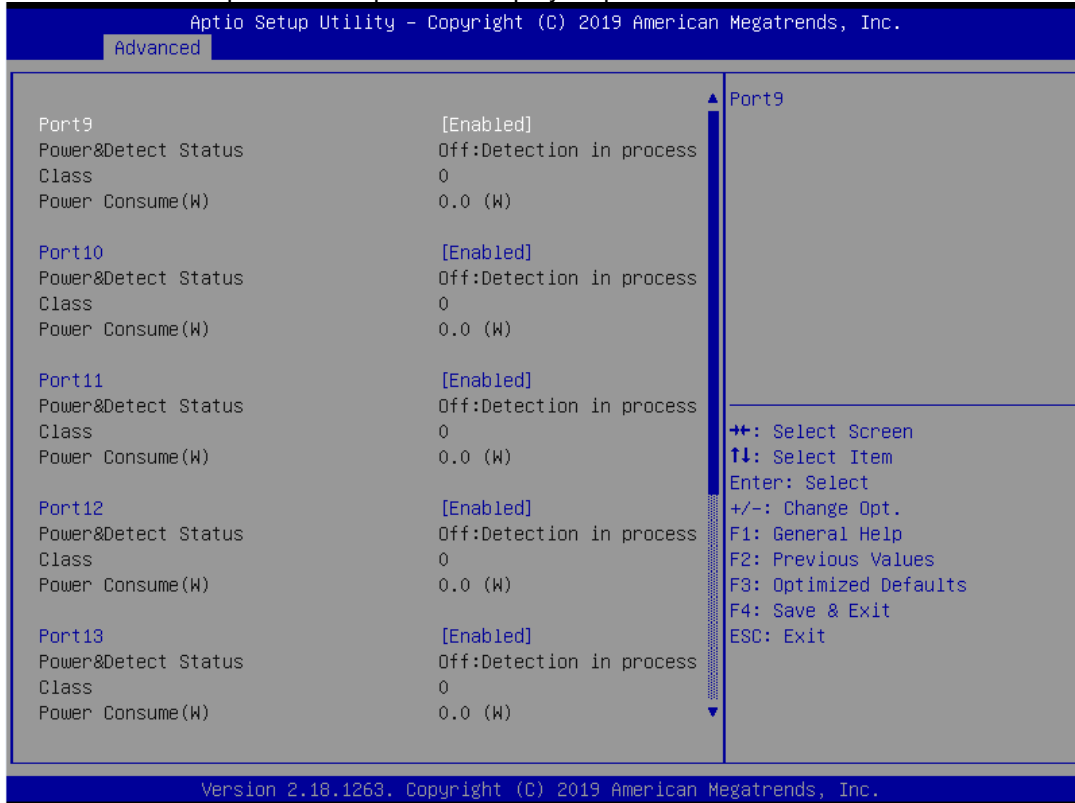

Port9~Port16

Enable/Disable a specific POE port and display all port status.

4.5 Chipset Menu

The Chipset menu allows users to change the advanced chipset settings. Users can select any of the items in the left frame of the screen to go to the sub menus:

- ▶ System Agent (SA) Configurations

For items marked with “▶”, please press <Enter> for more options.



System Agent (SA) Configurations

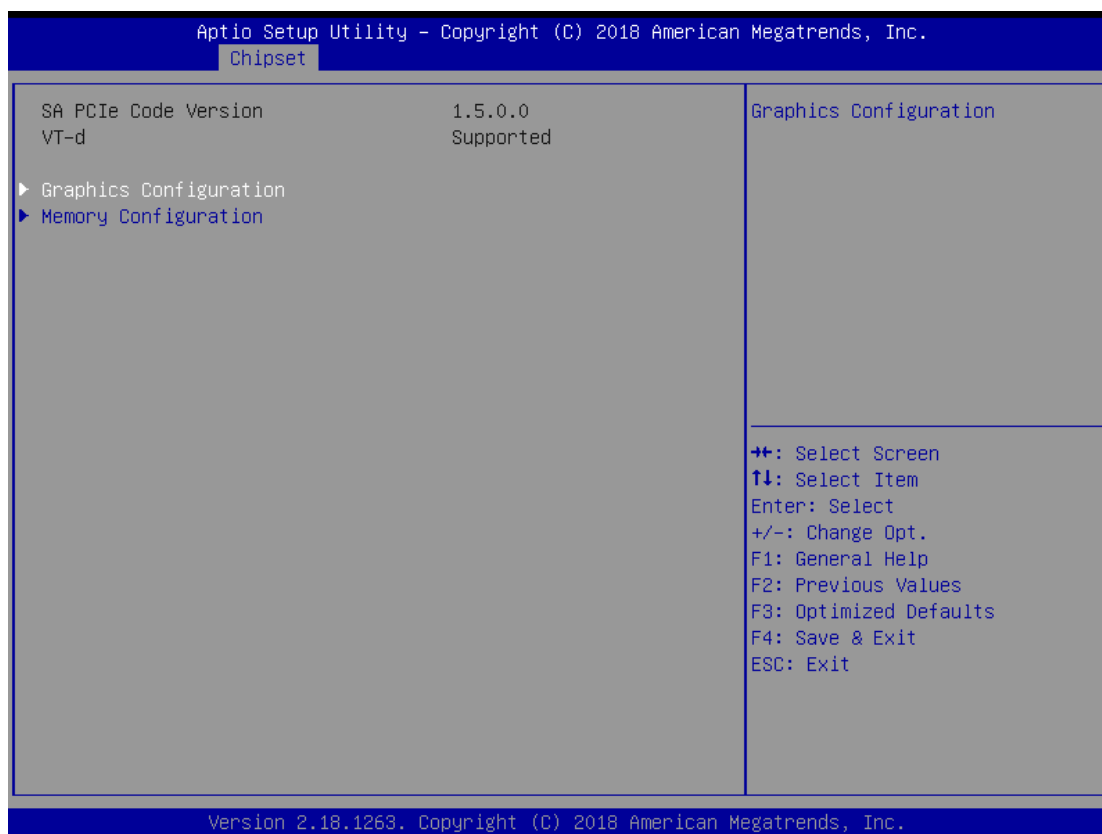

Graphics Configuration

Use this item to configure internal graphics controller.

Memory Configuration

Use this item to refer to the information related to system memory.

Graphic Configurations

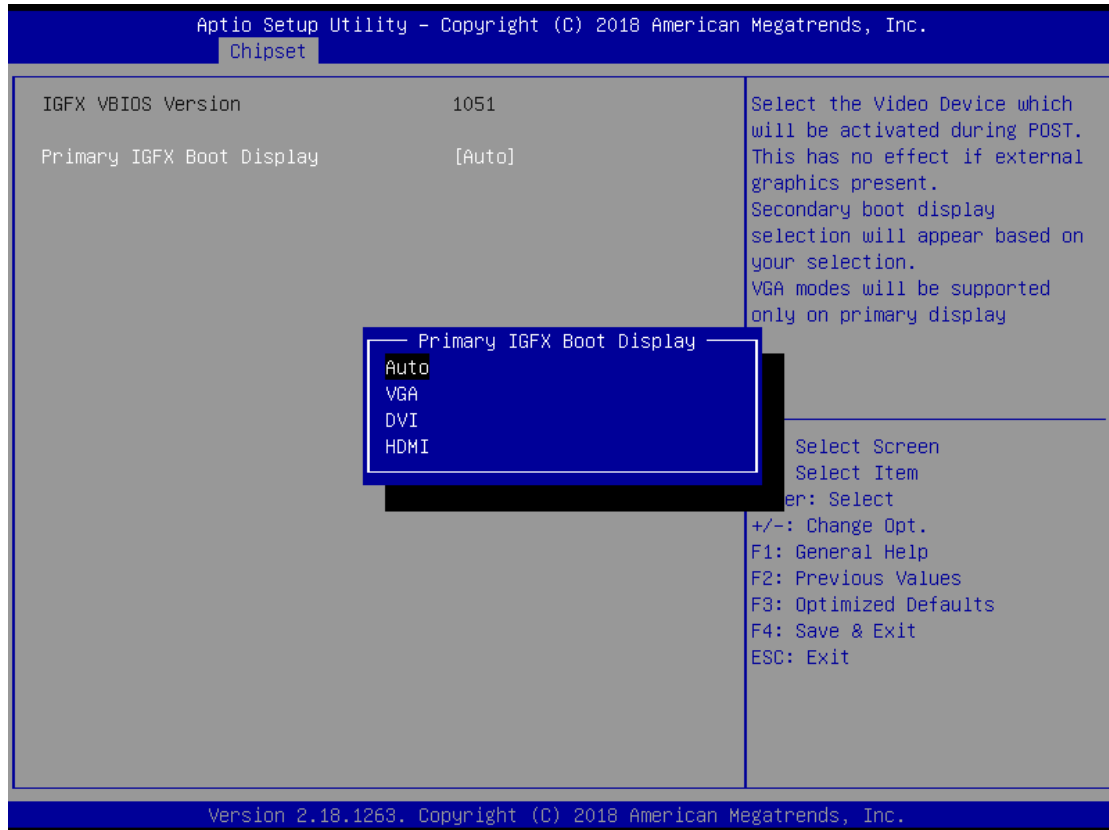

Primary IGFX Boot Display

Select the video device which will be activated during POST (Power-On Self-Test). The default is Auto.

Memory Configurations

This screen shows the system memory information.

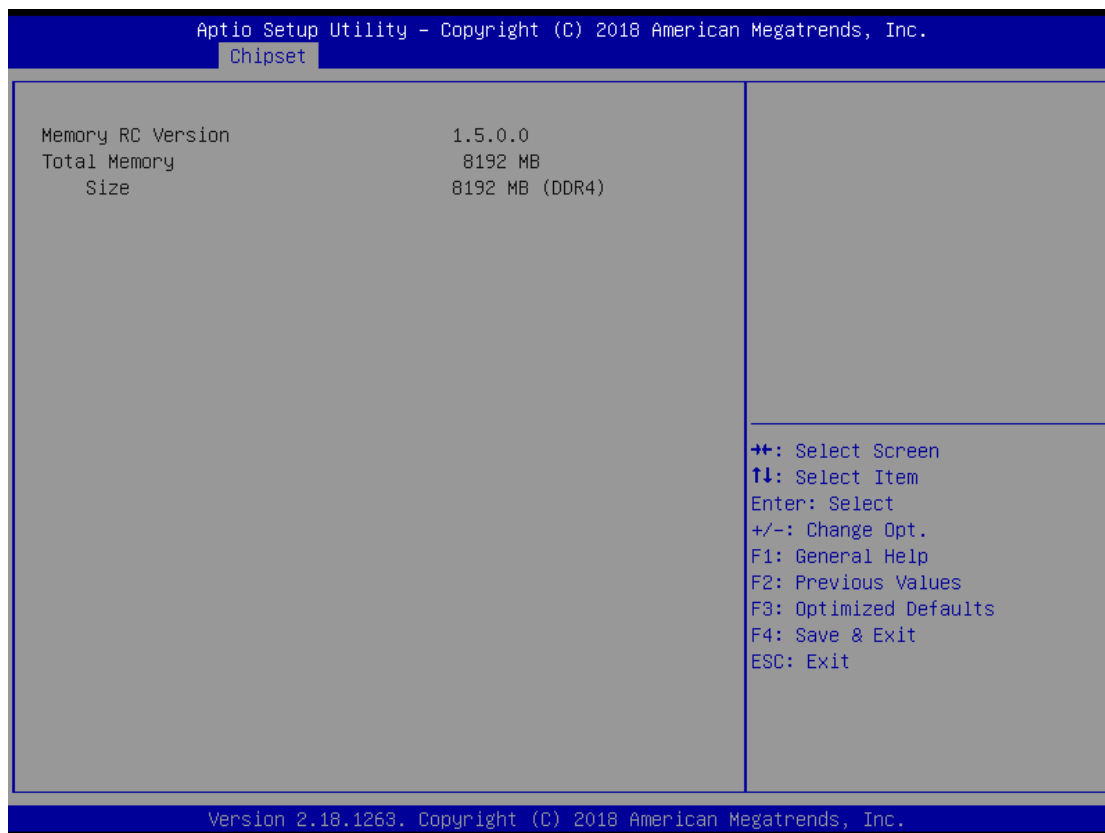

Security Menu

Aptio Setup Utility - Copyright (C) 2018 American Megatrends, Inc.					
Main Advanced Chipset Security Boot Save & Exit					
<p>Password Description</p> <p>If ONLY the Administrator's password is set, then this only limits access to Setup and is only asked for when entering Setup.</p> <p>If ONLY the User's password is set, then this is a power on password and must be entered to boot or enter Setup. In Setup the User will have Administrator rights.</p> <p>The password length must be in the following range:</p> <table> <tr> <td>Minimum length</td> <td>3</td> </tr> <tr> <td>Maximum length</td> <td>20</td> </tr> </table> <p>Administrator Password</p> <p>User Password</p>	Minimum length	3	Maximum length	20	<p>Set Administrator Password</p> <hr/> <p> ++: Select Screen ↑↓: Select Item Enter: Select +/-: Change Opt. F1: General Help F2: Previous Values F3: Optimized Defaults F4: Save & Exit ESC: Exit </p>
Minimum length	3				
Maximum length	20				
Version 2.18.1263. Copyright (C) 2018 American Megatrends, Inc.					

Administrator Password

This item indicates whether an administrator password has been set (installed or uninstalled).

User Password

This item indicates whether a user password has been set (installed or uninstalled).

4.6 Boot Menu

The Boot menu allows users to change boot options of the system.

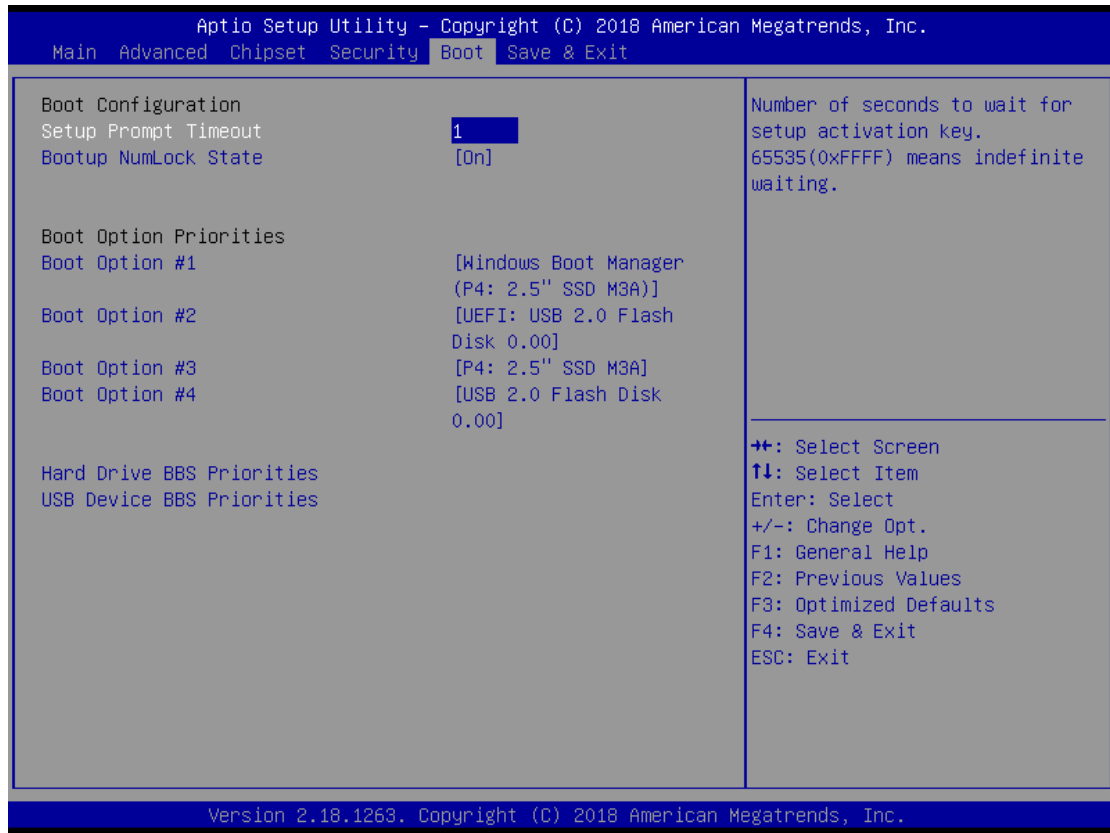

Setup Prompt Timeout

Use this item to set up number of seconds to wait for setup activation key where 65535(0xFFFF) means indefinite waiting.

Bootup NumLock State

Use this item to select the power-on state for the keyboard NumLock.

Boot Option Priorities

These are settings for boot priority. Specify the boot device priority sequence from the available devices.

4.7 Save & Exit Menu

The Save & Exit menu allows users to load system configurations with optimal or fail-safe default values.

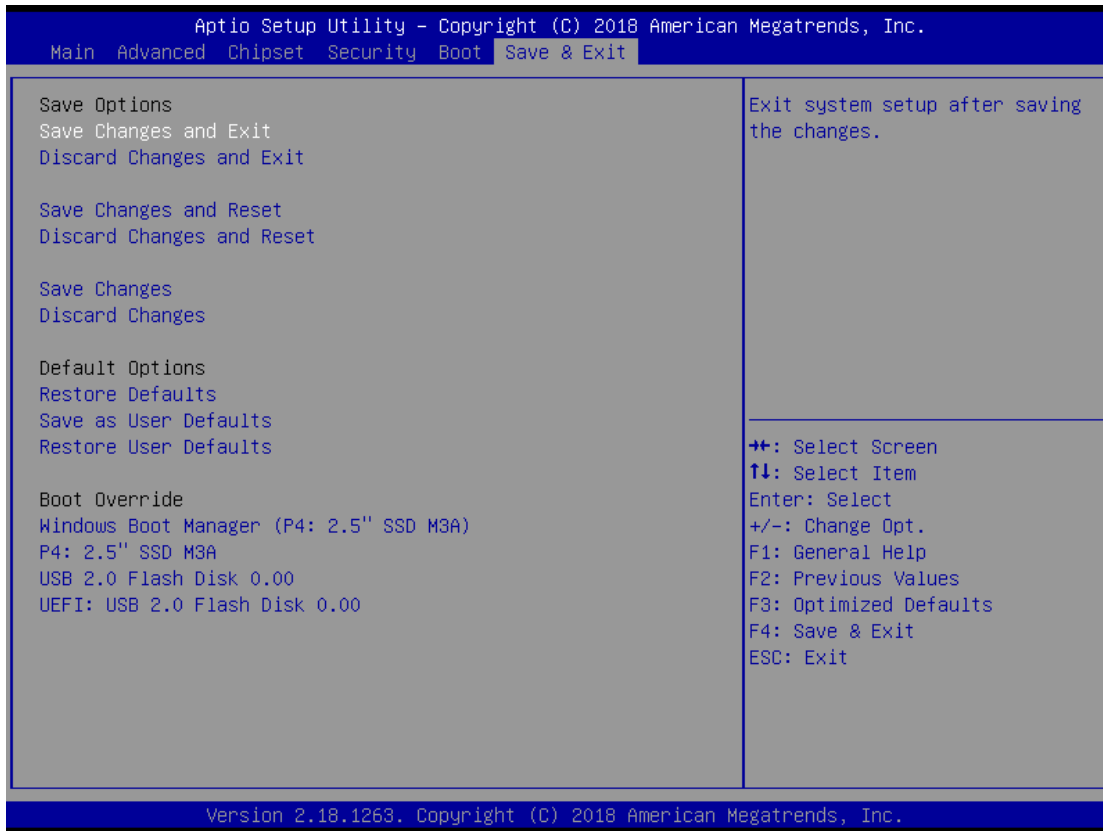

Save Changes and Exit

When users have completed the system configuration changes, select this option to leave Setup and return to Main Menu. Select Save Changes and Exit from the Save & Exit menu and press <Enter>. Select Yes to save changes and exit.

Discard Changes and Exit

Select this option to quit Setup without making any permanent changes to the system configurations and return to Main Menu. Select Discard Changes and Exit from the Save & Exit menu and press <Enter>. Select Yes to discard changes and exit.

Save Changes and Reset

When users have completed the system configuration changes, select this option to leave Setup and reboot the computer so the new system configurations take effect. Select Save Changes and Reset from the Save & Exit menu and press <Enter>. Select Yes to save changes and reset.

Discard Changes and Reset

Select this option to quit Setup without making any permanent changes to the system configuration and reboot the computer. Select Discard Changes and Reset from the Save & Exit menu and press <Enter>. Select Yes to discard changes and reset.

Save Changes

When completed the system configuration changes, select this option to save changes. Select Save Changes from the Save & Exit menu and press <Enter>. Select Yes to save changes.

Discard Changes

Select this option to quit Setup without making any permanent changes to the system configurations. Select Discard Changes from the Save & Exit menu and press <Enter>. Select Yes to discard changes.

Restore Defaults

It automatically sets all Setup options to a complete set of default settings when users select this option. Select Restore Defaults from the Save & Exit menu and press <Enter>.

Save as User Defaults

Select this option to save system configuration changes done so far as User Defaults. Select Save as User Defaults from the Save & Exit menu and press <Enter>.

Restore User Defaults

It automatically sets all Setup options to a complete set of User Defaults when users select this option. Select Restore User Defaults from the Save & Exit menu and press <Enter>.

Boot Override

Select a drive to immediately boot that device regardless of the current boot order.

APPENDIX A WATCHDOG TIMER

About Watchdog Timer

Software stability is a major issue in most applications. Some embedded systems are not watched by humans for 24 hours. It is usually too slow to wait for someone to reboot when a computer hangs. The system needs to be able to reset automatically when things go wrong. The watchdog timer gives us solutions in this regard.

The watchdog timer is a counter that triggers a system to reset when it counts down to zero from a preset value. The software starts the counter with an initial value and must reset it periodically. If the counter ever reaches zero, it means the software has crashed, the system will reboot.

How to Use the Watchdog Timer

The user can configure the watchdog timer using the watchdog function included in the AXVIEW2.0 software developed by Axiomtek, or using the debug.exe software released by Microsoft.



NOTE: The related tool for setting WDT will not be available on the official downloads area. If you need any tool, please contact Axiomtek's local distributor immediately.

Sample Program

The below sample code shows how to use DEBUG.exe in DOS mode to configure WDT function.

Enable watchdog timer

STEP	Sample code	Note
3. Enter configuration mode	0 2E 87	Un-lock super I/O
	0 2E 87	Un-lock super I/O
4. Select logic device	0 2E 07	Select logic register
	0 2F 08	Switch to WDT device
5. Enable WDT device	0 2E 30	Select register
	0 2F 01	Enable WDT
6. Set time unit	0 2E F0	Select logic register
	0 2F M	M = 08h (Minute) , M = 00h (Second)
7. Set timer	0 2E F1	Select logic register
	0 2F 0A	Set timer (where 0A (hex) = 10sec)

Disable watchdog timer

STEP	Sample code	Note
1. Enter configuration mode	○ 2E 87	Un-lock super I/O
	○ 2E 87	Un-lock super I/O
2. Select logic device	○ 2E 07	Select logic register
	○ 2F 08	Switch to WDT device
3. Disable WDT device	○ 2E 30	Select register
	○ 2F 00	Disable WDT

APPENDIX B DIGITAL I/O

Digital I/O Specification

Digital Input:

Input channels: 6, sink/source type

Input voltage: 0 to 30VDC

Input level for dry contacts:

Logic level 0: close to ground

Logic level 1: open

Input level for wet contacts:

Logic level 1: +/-3VDC max.

Logic level 0: +/- 10VDC min. to +/-30VDC max. (source to digital input)

Digital output:

output channels: 2, sink type

output current: 200mA max. per channel

on-state voltage: 12~ 24VDC nominal

Isolation: 1.5 KV

Max voltage on COM+: 30VDC

Digital I/O & DIO LED Software Programming

Digital I/O and LEDs are controlled by General Purpose Input / Output (GPIO) in Super IO. The relevant control positions are as follows:

- Super IO GPIO4 Group(GPIO40~47), Location: Address F1h for setting DIO.
- GPIO40~41 is output(Digital Output),GPIO42~47 is(Digital Input),setting DATA from Logic Device 7,F0~F3.
- Super IO GPIO3 Group(GPIO30~37), Location: Address ECh for setting Programming LED.
- GPIO30~31 is DI/DO Programming LED, setting DATA from Logic Device 7,EC~EF.

CR F1h. GPIO4 Data Register

Location: Address F1h

Attribute: Read/Write

Power Well: VSB

Reset by: GP4X_MRST

Default : 00h

Size: 8 bits

BIT	READ / WRITE	DESCRIPTION
7-0	R / W	GPIO4 Data register For output ports, the respective bits can be read/written and produced to pins.

GPIO4 Group

Enable: Logic Device 7, CR30[4]

Data: Logic Device 7, F0~F3

Multi-function: YLW, GRN, PLED, SMI (Logic Device 8, CRE4[7-0])

Reset: Logic Device 9, CRE2[4]

OD/PP: Logic Device F, CRE4

CR ECh. GPIO3 I/O Register

Location: Address ECh

Attribute: Read/Write

Power Well: VSB

Reset by: GP3X_MRST

Default : FFh

Size: 8 bits

BIT	READ / WRITE	DESCRIPTION
7-0	R / W	GPIO3 I/O register 0: The respective GPIO3 PIN is programmed as an output port 1: The respective GPIO3 PIN is programmed as an input port.

GPIO3 Group

Enable: Logic Device 7, CR30[3]

Data: Logic Device 7, EC~EF

Multi-function: BEEP, SMI, WDTO#, SUSLED (Logic Device 8, CRE3[7-0])

Reset: Logic Device 9, CRE2[3]

OD/PP: Logic Device F, CRE3

Digital Input Wiring

DRY contact

Logic level 0: close to ground
 Logic level 1: open

DRY

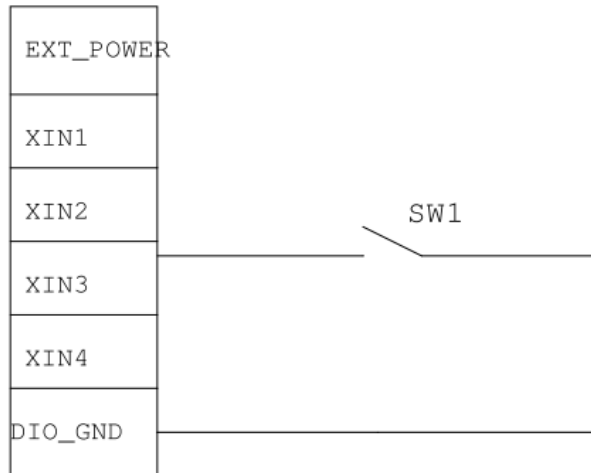

WET contact

Logic level 1: +/-3VDC max.
 Logic level 0: +/- 10VDC min. to +/-30VDC max

WET

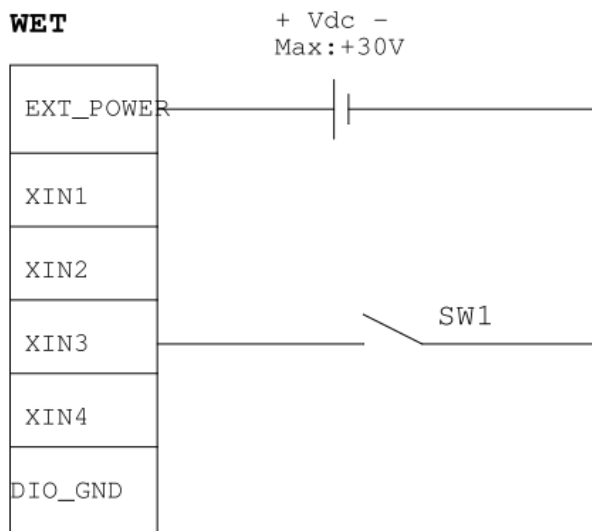

Digital Output Wiring

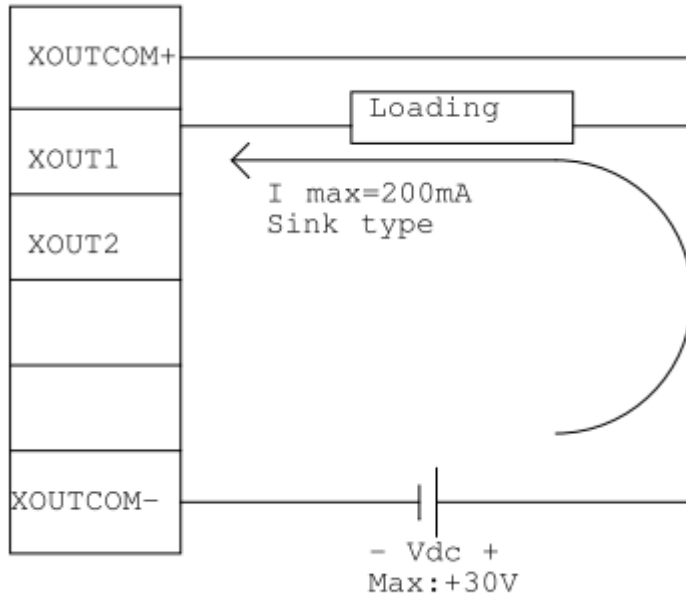

About Programmable Digital I/O

LED UST500-517-FL supports isolated digital I/O which allows the user to control 6DI or 2DO. Please refer to Driver CD for sample code and demo tool to check.



[Note] *DIO Status Bit1~2 are DO and can be selected to check active low for DO. LED bit1 corresponds to front side P0 LED; LED bit2 corresponds to front side P1 LED. LED bit1 and LED bit2 can be selected to check LED off.*

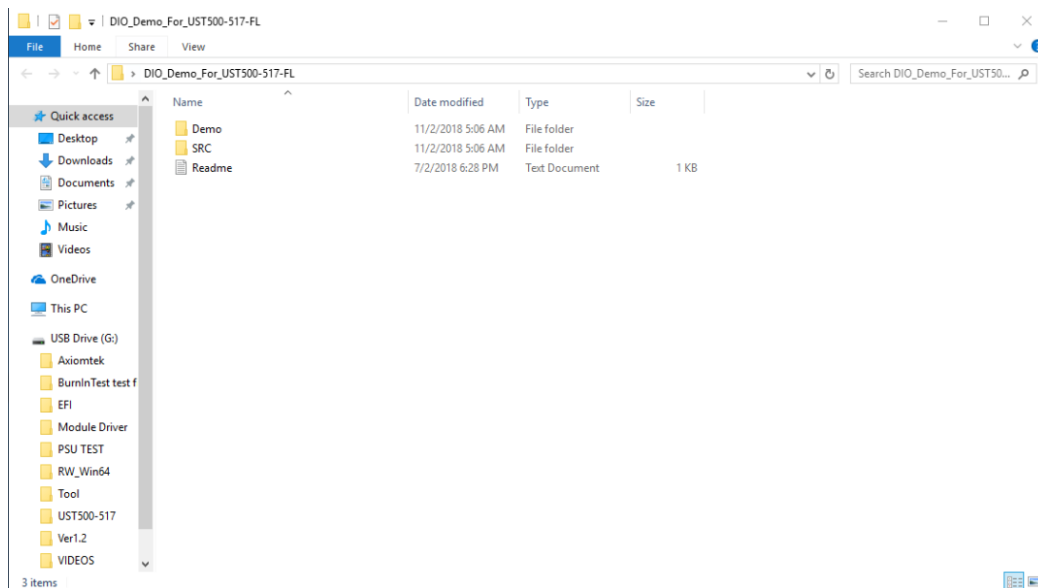

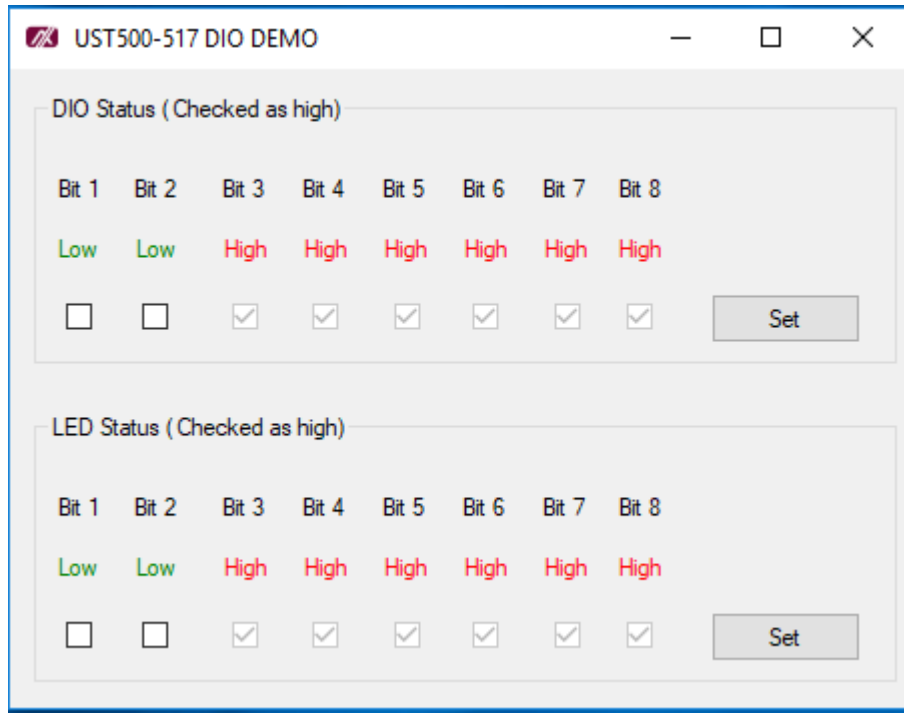

This page is intentionally left blank.

APPENDIX C CONFIGURING SATA FOR RAID

Configuring SATA Hard Drive(s) for RAID (Controller: Intel® Q170)

Before you begin the SATA configuration, please prepare four SATA hard drives (to ensure optimal performance, it is recommended that you use two hard drives with the identical model and capacity). If you do not want to create RAID with the SATA controller, you may prepare only one hard drive.

Please follow the steps below to configure SATA hard drive(s):

1. Install SATA hard drive(s) in your system.
2. Enter the BIOS Setup to configure SATA controller mode and boot sequence.
3. Configure RAID using the RAID BIOS.

1. Installing SATA hard drive(s) in your system.

Connect one end of the SATA signal cable to the rear of the SATA hard drive, and the other end to an available SATA port on the board. Then, connect the power connector of power supply to the hard drive.

2. Configuring SATA controller mode and boot sequence by the BIOS Setup.

You have to make sure whether the SATA controller is configured correctly by system BIOS Setup and set up BIOS boot sequence for the SATA hard drive(s).

- 2.1. Turn on your system, and then press the button to enter BIOS Setup during running POST (Power-On Self-Test). If you want to create RAID, just go to the Advanced Settings menu\SATA Configuration, select the "SATA Mode Selection", and press <Enter> for more options.

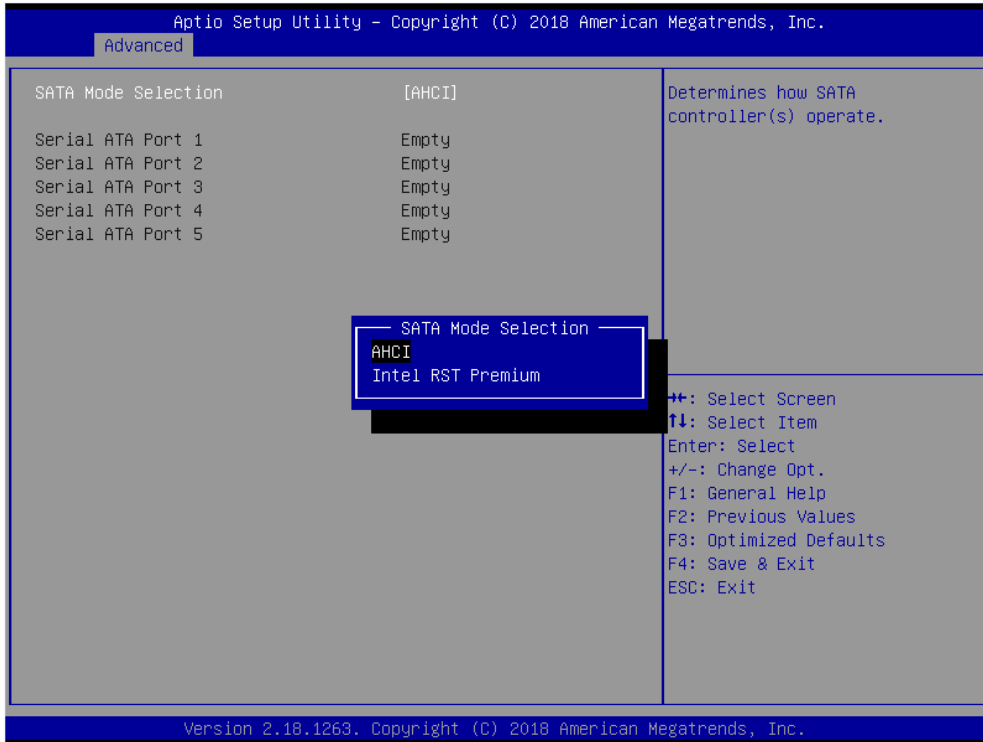

A list of options appears. Please select "Intel RST Premium".

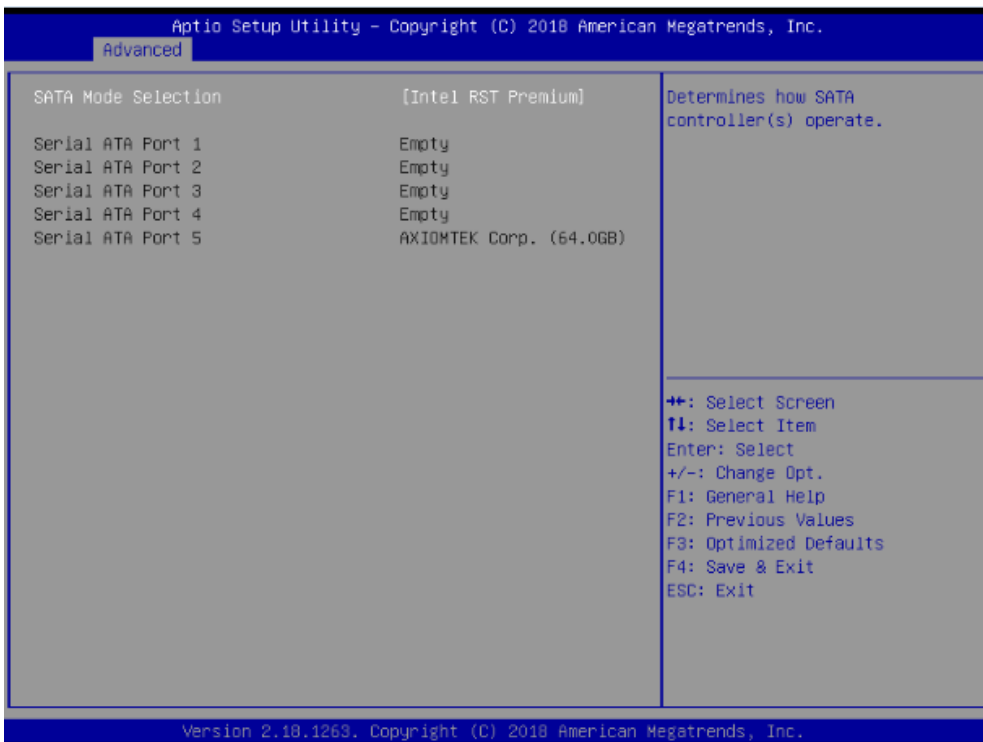

- 2.2. Save and exit the BIOS Setup.

3. Configuring RAID by the RAID BIOS.

Enter the RAID BIOS setup utility to configure a RAID array. Skip this step and proceed if you do not want to create a RAID.

- 3.1. After the POST memory testing and before the operating system booting, a message "Press <Ctrl-I> to enter Configuration Utility" shows up. Press <Ctrl + I> to enter the RAID BIOS setup utility.

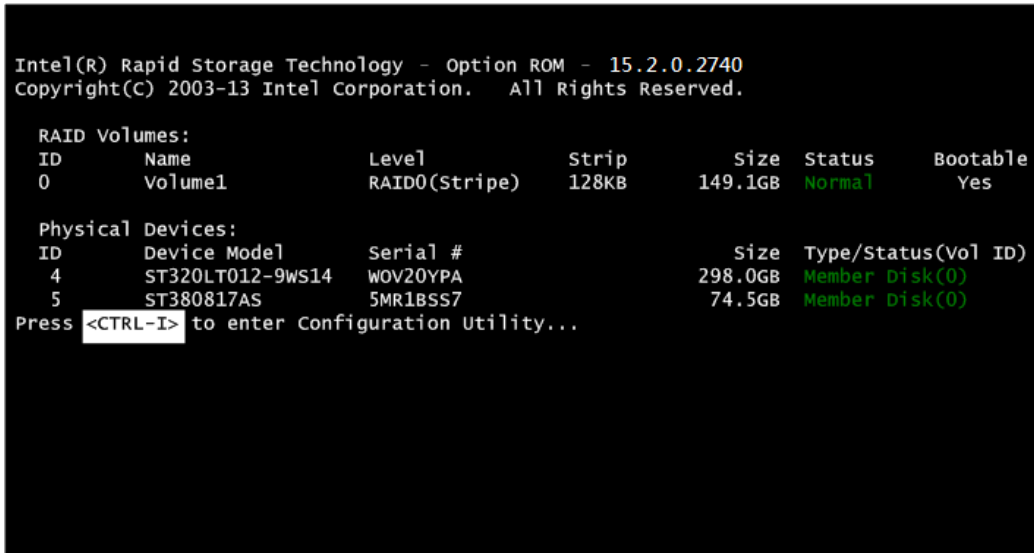

- 3.2. After you press <Ctrl + I>, the Create RAID Volume screen will appear. If you want to create a RAID array, select the Create RAID Volume option in the Main Menu and press <Enter>.

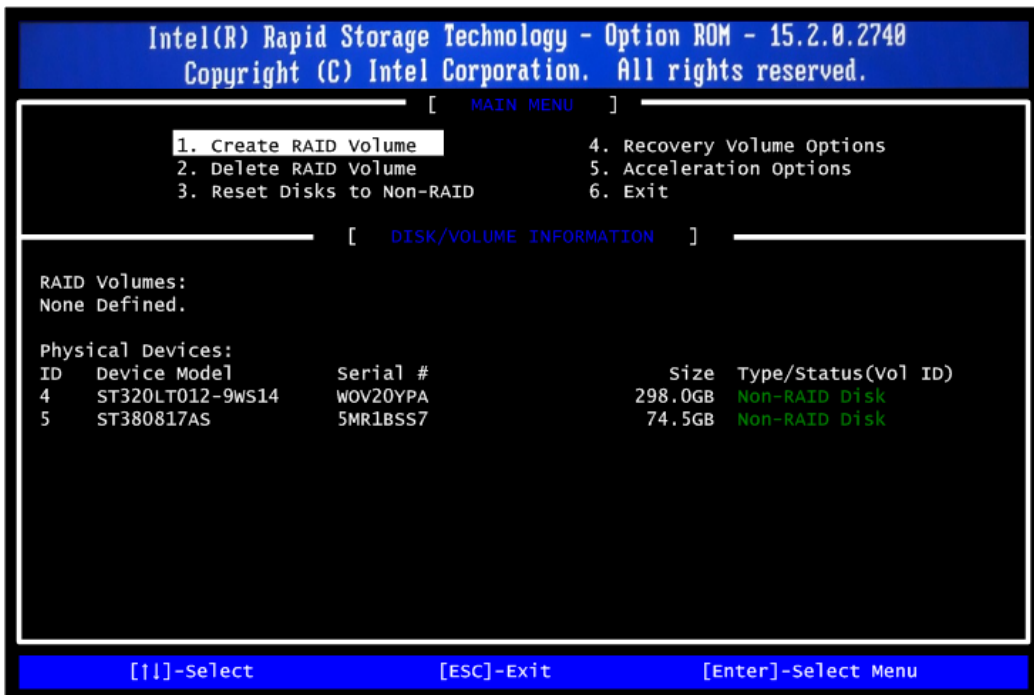

- 3.3. After entering the Create Volume Menu screen, you can type the disk array name with

1~16 letters (letters cannot be special characters) in the item "Name:".

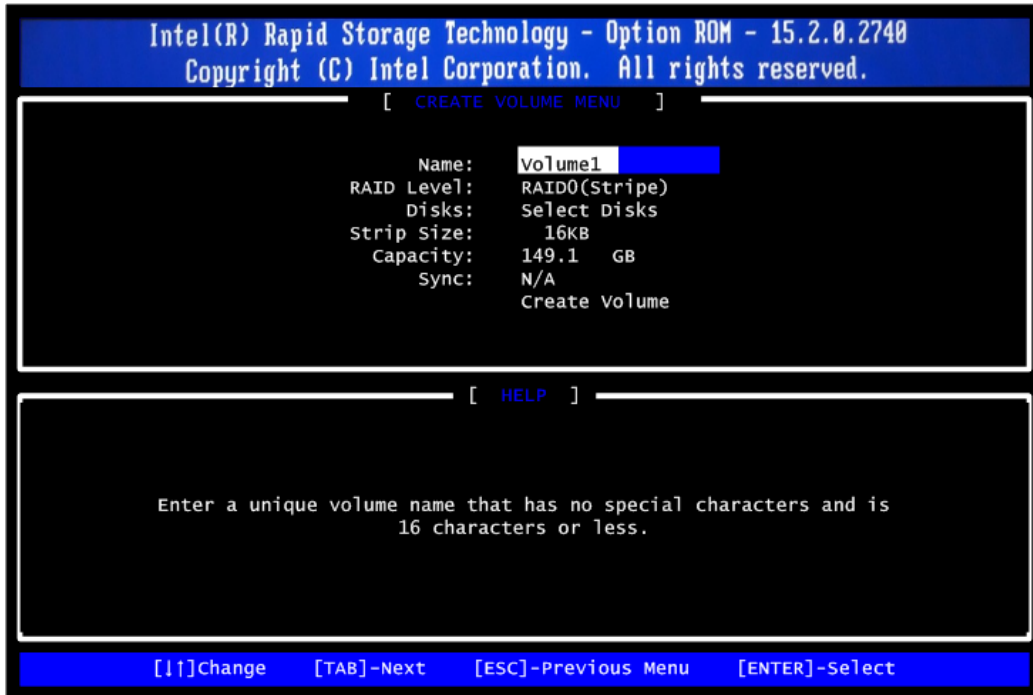

3.4. When finished, press <Enter> to select a RAID level. There are three RAID levels: RAID0, RAID1, RAID5 and RAID10. Select a RAID level and press <Enter>.



3.5. Set the stripe block size. The KB is the standard unit of stripe block size. The stripe block size can be 4KB to 128KB. After the setting, press <Enter> for the array capacity.

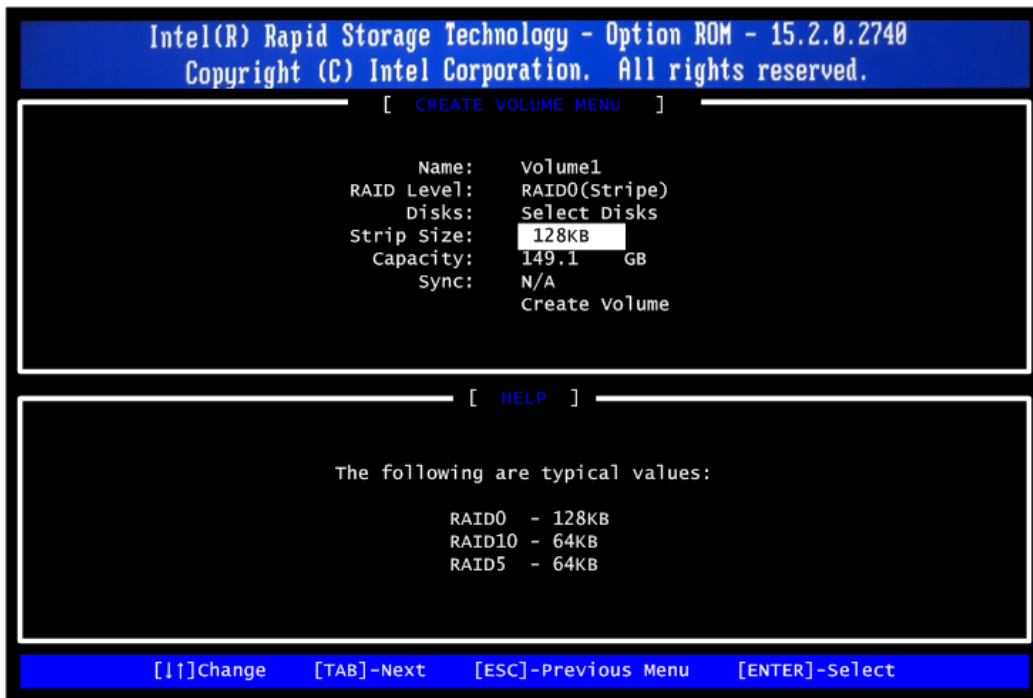

- 3.6. After setting all the items on the menu, select Create Volume and press <Enter> to start creating the RAID array.

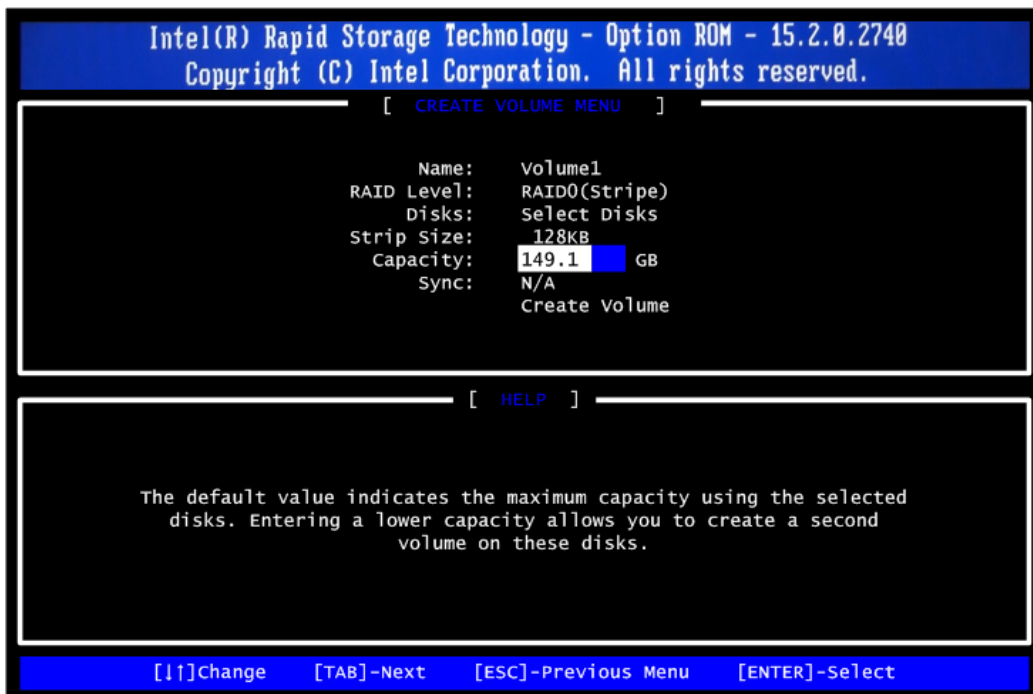

3.7. When prompting the confirmation, press <Y> to create this volume, or <N> to cancel the creation.

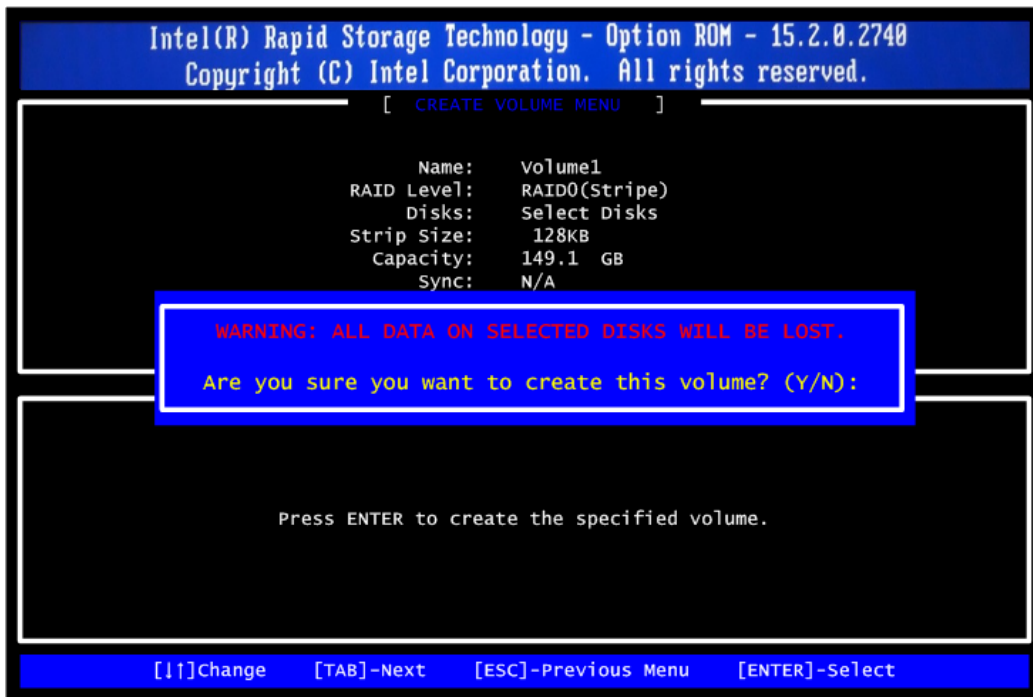

3.8. After the creation is completed, you will see detailed information about the RAID array in the Disk/Volume Information section, including RAID mode, disk block size, disk name, disk capacity, etc.

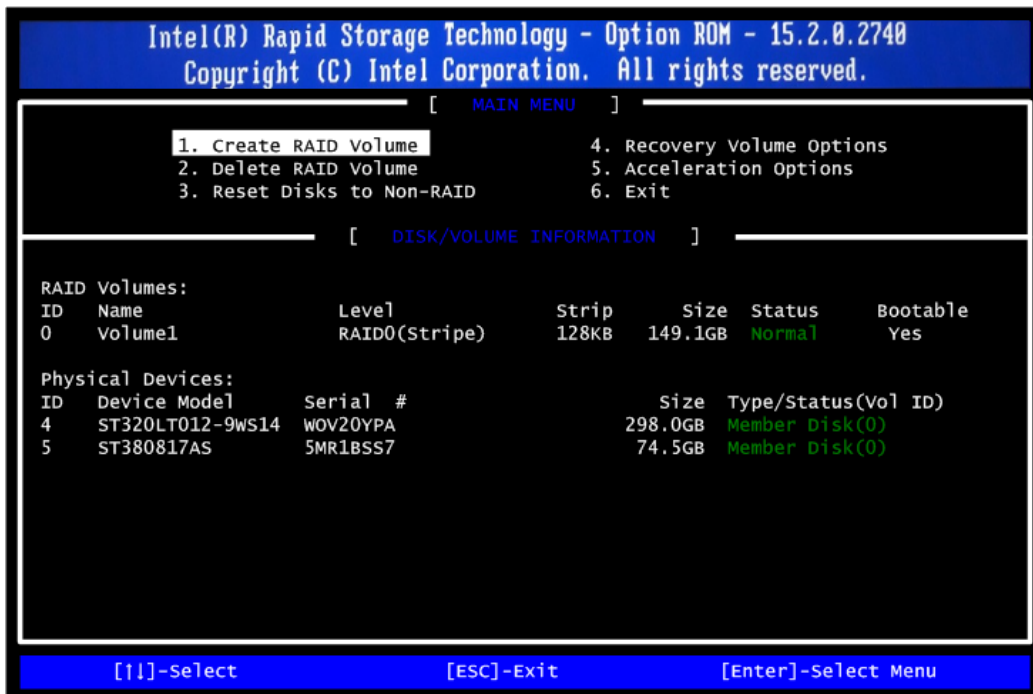

Delete RAID volume

If you want to delete a RAID volume, select the Delete RAID Volume option in Main Menu. Press <Enter> and follow on-screen instructions.

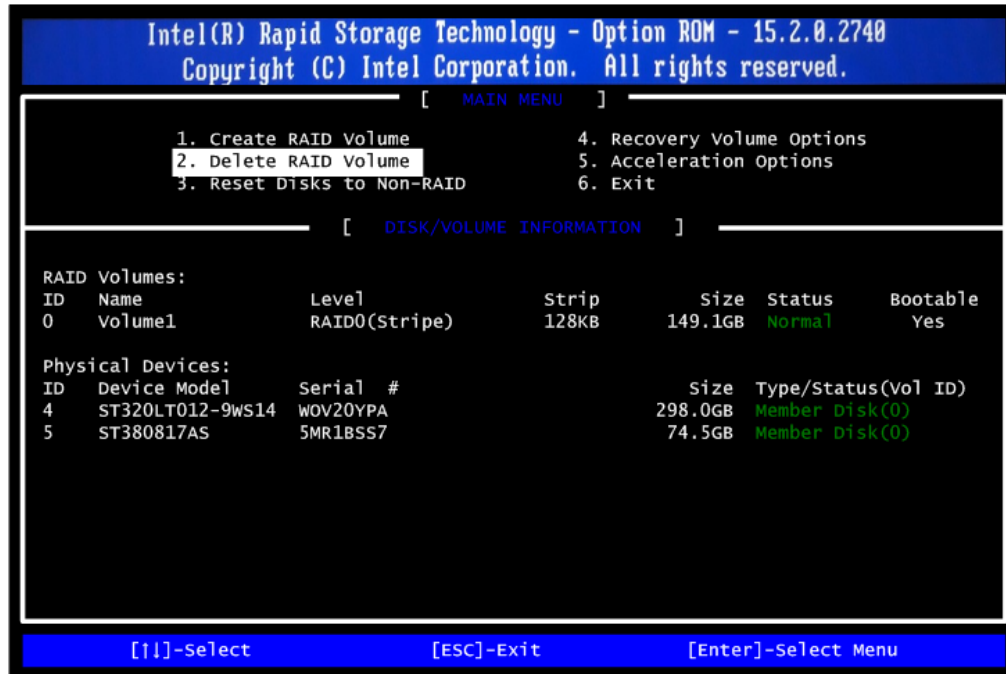

Please press <Esc> to exit the RAID BIOS utility. Now, you can proceed to install a SATA driver controller and the operating system.

This page is intentionally left blank.

APPENDIX D POWER BUTTON SETTING FOR WINDOWS

To enable the power button function, go to the console of the PC and then follow the instruction below to complete the setting.

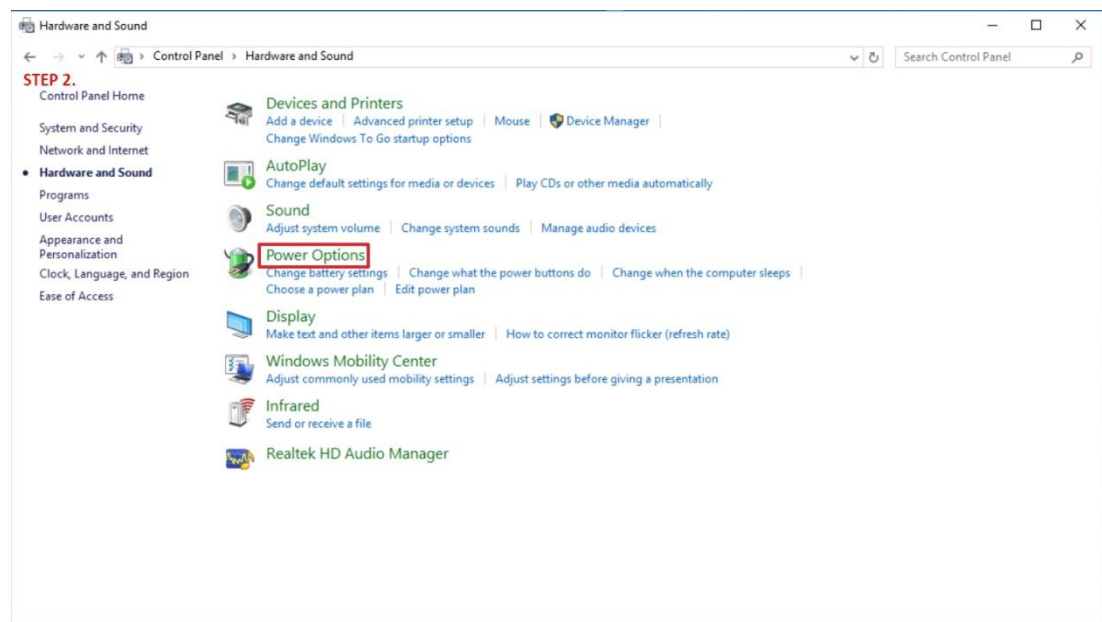
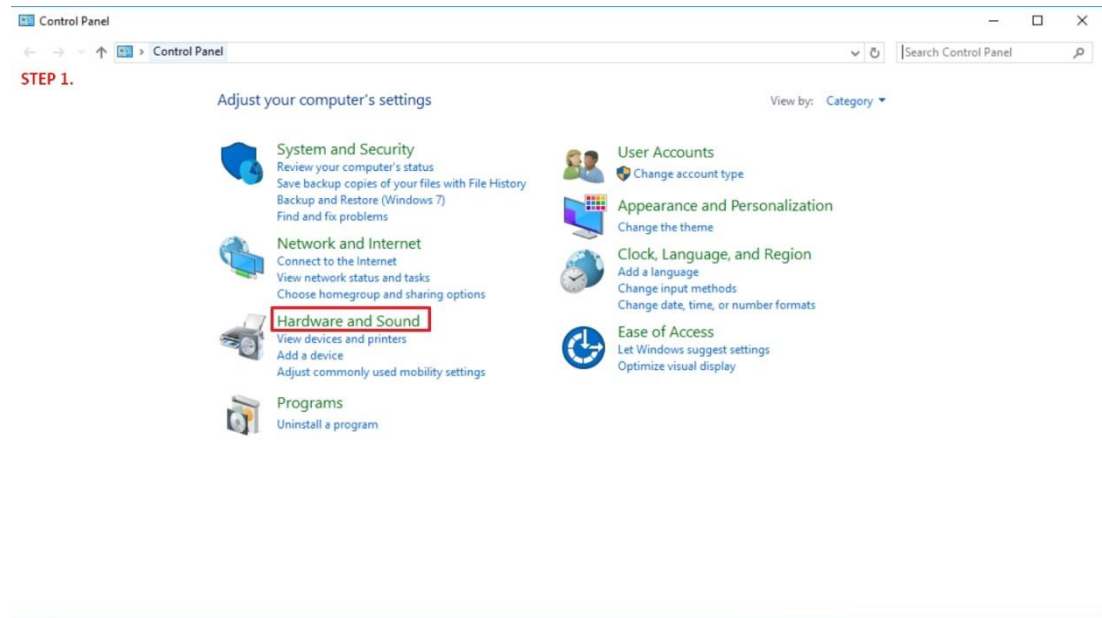

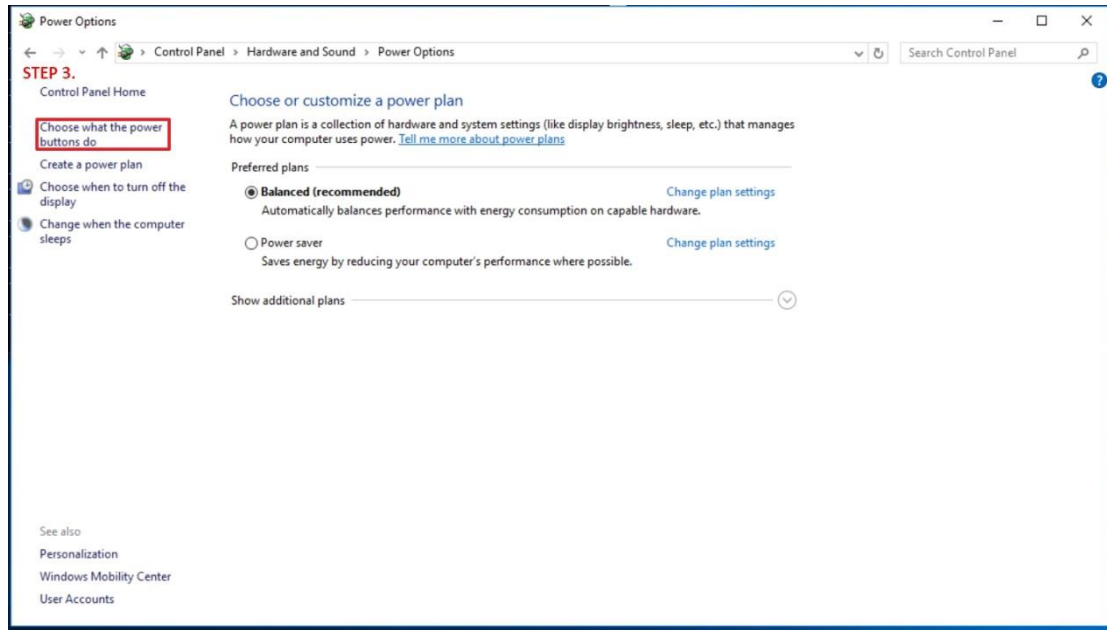

Please check if the action of pressing power button is "Shut down" to let ACC works normally and preventing unexpected hard shut down.

