

USER'S MANUAL

MVS100-323-FL
Mini Fanless Vision System

User's Manual



www.axiomtek.com

Disclaimers

This manual has been carefully checked and believed to contain accurate information. Axiomtek Co., Ltd. assumes no responsibility for any infringements of patents or rights of any third party, or any liability arising from such use.

Axiomtek does not warrant or assume any legal liability or responsibility for the accuracy, completeness or usefulness of any information in this document. Axiomtek does not make any commitment to update the information in this manual.

Axiomtek reserves the right to change or revise this document and/or product at any time without notice.

No part of this document may be reproduced, stored in a retrieval system, or transmitted, in any form or by any means, electronic, mechanical, photocopying, recording, or otherwise, without the prior written permission of Axiomtek Co., Ltd.

©Copyright 2021 Axiomtek Co., Ltd.

All Rights Reserved

April 2021, Version A2

Printed in Taiwan

ESD Precautions

The boards have integrated circuits sensitive to static electricity. To avoid damaging chipsets from electrostatic discharge, observe the following precautions:

- Do not remove boards or integrated circuits from their anti-static packaging until you are ready to install them.
- Before handling a board or integrated circuit, touch an unpainted portion of the system unit chassis for a few seconds. This will help to discharge any static electricity on a human body.
- When handling boards and components, wear a grounding wrist strap available from most electronic component stores.

Trademarks Acknowledgments

Axiomtek is a trademark of Axiomtek Co., Ltd.

Windows[®] is a trademark of Microsoft Corporation.

IBM, PC/AT, PS/2, VGA are trademarks of International Business Machines Corporation.

Intel[®] is a trademark of Intel Corporation.

Other brand names and trademarks are the properties and registered brands of their respective owners.

Table of Contents

Disclaimers.....	ii
ESD Precautions	iii
Section 1 Introduction.....	1
1.1 General Description	1
1.2 System Specifications	2
1.2.1 Main CPU Board	2
1.2.2 I/O System.....	2
1.2.3 General Specification	2
1.2.4 Vision I/O (12-pin terminal connector)	3
1.2.5 LED Lighting control (4-pin terminal connector)	4
1.3 Dimensions.....	5
1.4 I/O Outlet.....	6
1.5 Packing List.....	7
1.6 Switch Settings & Wafer connector.....	8
1.6.1 AT/ATX Mode & Clear CMOS Optimal Defaults (SW1)	8
1.6.2 Wafer Connector for optional USB dongle (CN6)	9
1.7 Connectors	9
1.7.1 Mini Card Slot.....	10
1.7.2 LAN	11
1.7.3 USB	12
1.7.4 VGA Connector	12
1.7.5 DC-in Power Connector	13
1.7.6 HDMI Connector.....	13
1.7.7 ATX Power On/OFF Button & HDD LED Indicate	14
1.7.8 4-Pin Terminal Connector for LED Lighting Control	15
1.7.9 12-Pin Female I/O Connector	15
1.7.10 COM	16
1.7.11 PD Power Indicator & GigE1 ~ GigE2 ports.....	17
Section 2 Hardware Installation	19
2.1 Installing the Memory Module.....	19
2.2 Installing the PCI Express Mini Card.....	20
2.3 Installing an internal USB dongle (Option)	22
2.4 Installing Dail-rail mounting	23
2.5 Wall-mount bracket kit (Option)	24
Section 3 I/O Connection.....	27
3.1 I/O Connection (12-pin terminal connector).....	27

3.1.1	Isolated Digital Input & Trigger Input.....	27
3.1.2	Isolated Digital Output & Trigger Output	28
3.2	I/O Connection (4-pin terminal connector).....	29
3.2.1	LED Lighting Control	29
Section 4 Operating.....		31
4.1	Operating	31
4.1.1	Trigger Input/ Output	31
4.1.2	LED Lighting Control	32
4.1.3	Interrupt	32
4.2	Application.....	33
4.2.1	Scenario	33
Section 5 AMI BIOS Utility		35
5.1	Setting.....	35
5.2	Navigation Keys	36
5.3	Main Menu.....	37
5.4	Advanced Menu.....	38
5.5	Chipset.....	50
5.6	Security Menu.....	51
5.7	Boot Menu.....	52
5.8	Save & Exit Menu	53
Appendix A Watchdog Timer		55
A.1	About Watchdog Timer	55
A.2	How to Use Watchdog Timer.....	55

Section 1

Introduction



This section contains general information and detailed specifications of the MVS100 Series Vision System, including the following sections:

- General Description
- Features
- Specifications
- Dimensions

1.1 General Description

The MVS100-323-FL is a mini fanless vision system that comes with an Intel® Atom® x5-E3940 processor. It integrates dual camera interfaces and special vision I/O features for machine vision applications, including GigE camera support, trigger input and output with microsecond-scale real-time control, as well as LED lighting output with constant current control to allow easy integration of any lighting source. To meet various usage needs, the vision system can deliver high quality images for analysis when being used with inspection software. The MVS100 can be deployed in factories to improve product quality and increase productivity, and is suitable for the operations of fill level, label presence, OCR inspection, etc. The system is compatible with any vision control system to simplify deployment of your machine vision applications.

- **Features**
 - Integrated vision I/O
 - 2 CH trigger input
 - 2 CH trigger output
 - 2 CH LED lighting control
 - 4 CH isolated DIO
 - Supports camera interfaces
 - 2 IEEE802.3af GbE LAN ports (PoE)
 - 2 USB 3.2 Gen 1 ports
 - Power input: 24 VDC

- -10°C to +55°C operating temperature range
- Supports TPM 2.0 function

1.2 System Specifications

1.2.1 Main CPU Board

- **CPU**
 - Intel® Atom® x5-E3940 processor (1.6GHz)
- **Chipset**
 - SoC integrated
- **BIOS**
 - AMI BIOS
- **System memory**
 - One DDR3L SO-DIMM, up to 8GB

1.2.2 I/O System

- **Standard I/O interface**
 - One power button (tactile switch with LED)
 - DC to DC power supply, supports 24VDC±10%
 - Two USB 3.2 Gen 1 type-A connectors
 - HDD access LED
 - One GbE LAN port (i211AT)
 - One VGA supports resolution up to 1920 x 1200 @60Hz
 - One HDMI 1.4b supports resolution up to 3840 x 2160 @30Hz
 - One RS-232/422/485
- **Expansion interface**
 - One full-size PCI Express Mini Card slot with mSATA signal for storage
- **Camera interface**
 - Two GbE LAN ports with PoE (Intel® i210-AT, IEEE802.3af compliant per port, total max. power output 20W)

1.2.3 General Specification

- **Operation temperature**
 - -10°C to +55°C (+14°F to +131°F)
- **Storage temperature**
 - -20°C to +80°C (-4°F to +176°F)
- **Humidity**
 - 10% ~ 90% (Non-condensing)

- **Dimensions**

- 53 mm (2.1") (W) x 155 mm (6.1") (H) x 110 mm (4.3") (D)

1.2.4 Vision I/O (12-pin terminal connector)

- **Isolated digital input**

- Number of channels: 2
- Input type: wet contact: sink/source and dry contact
- Input level for dry contact:
Close to ground (Logic 1), Open (Logic 0)
- Input level for wet contact:
Input voltage: on (logic 1): 10~30VDC, off (logic 0): 0~3VDC
Isolation voltage: 2kV
- Supports programmable de-bounce filter (disable, 100us, 500us, 1ms, 5ms)

- **Isolated digital output**

- Number of channels: 2
- Output type: sink, open collector
- Supply voltage: 5-30VDC
- Output current: Max. 100mA per channel
- Isolation voltage: 2kV

- **Isolated trigger input**

- Number of channels: 2
- Input type: wet contact: sink/source and dry contact
- Input level for dry contact:
Close to ground (Logic 1), Open (Logic 0)
- Input level for wet contact:
Input voltage: on (logic 1): 10~30VDC, off (logic 0): 0~3VDC
- Response time: <100us (from trigger input to trigger output)
- Isolation voltage: 2kV
- Supports programmable de-bounce filter (disable, 100us, 500us, 1ms, 5ms)
- Trigger Input can be configured to DI by API

- **Isolated trigger output**

- Number of channels: 2
- Output voltage: 5-30VDC, sink, open collector
- Output current: Max. 100mA per channel
- Response time: <100us (from trigger input to trigger output)
- Isolation voltage: 2kVDC
- Trigger sources: 2CH trigger input (Each channel supports two sources.)
- Trigger output can be configured to DO by API

- **Interrupt**
 - Sources: two digital inputs and two trigger inputs

1.2.5 LED Lighting control (4-pin terminal connector)

- **LED lighting control**
 - Number of channels: 2
 - Constant current control
 - Operating mode: strobe and continuous mode
 - LED output: 12/24VDC; Max. 0.5A per channel
Delay time & duration time: 1 μ s to 65ms; 1ms to 65s (time unit: 1us, 16bit/ 1ms, 16bit)
 - Output current step size: 10mA by software
 - Trigger source: Each channel supports two sources (Trigger input 0/1)



Note: All specification and images are subject to change without notice.

1.3 Dimensions

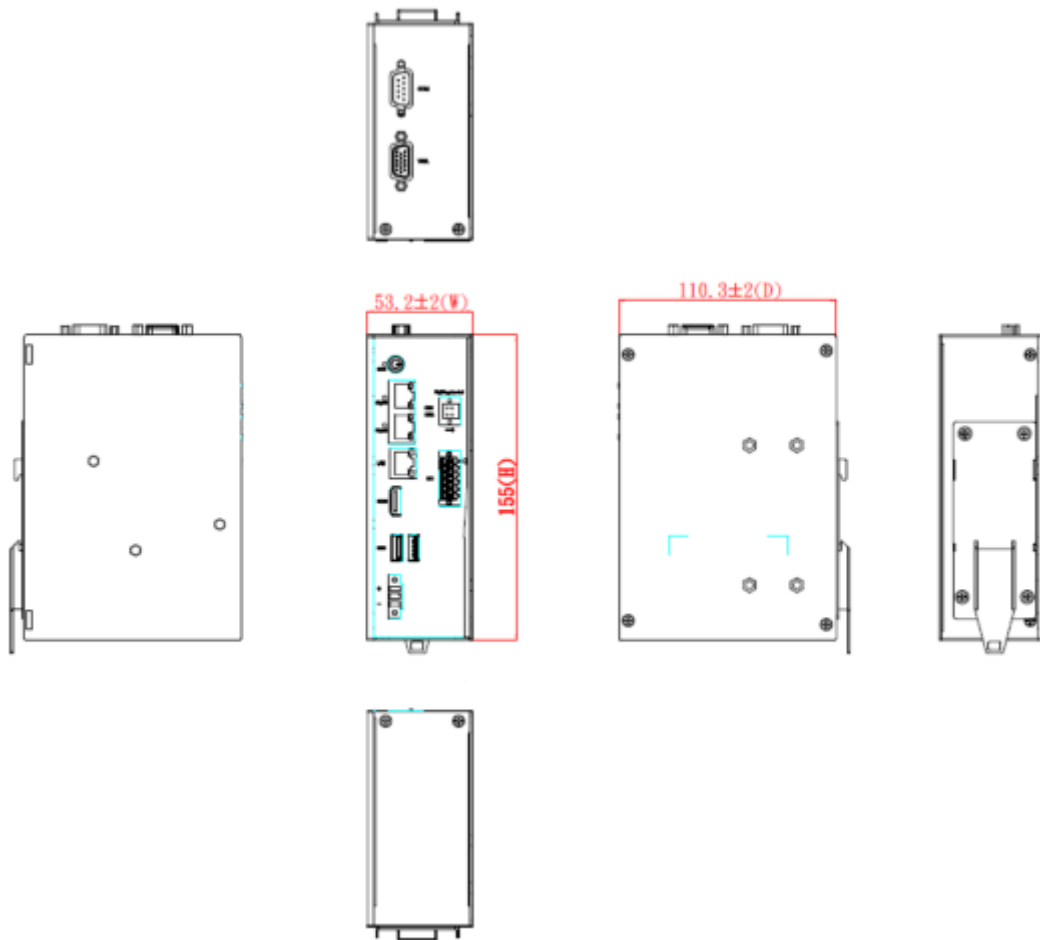

1.4 I/O Outlet

The following figure shows you the I/O outlets on the front and rear panels of the MVS100.

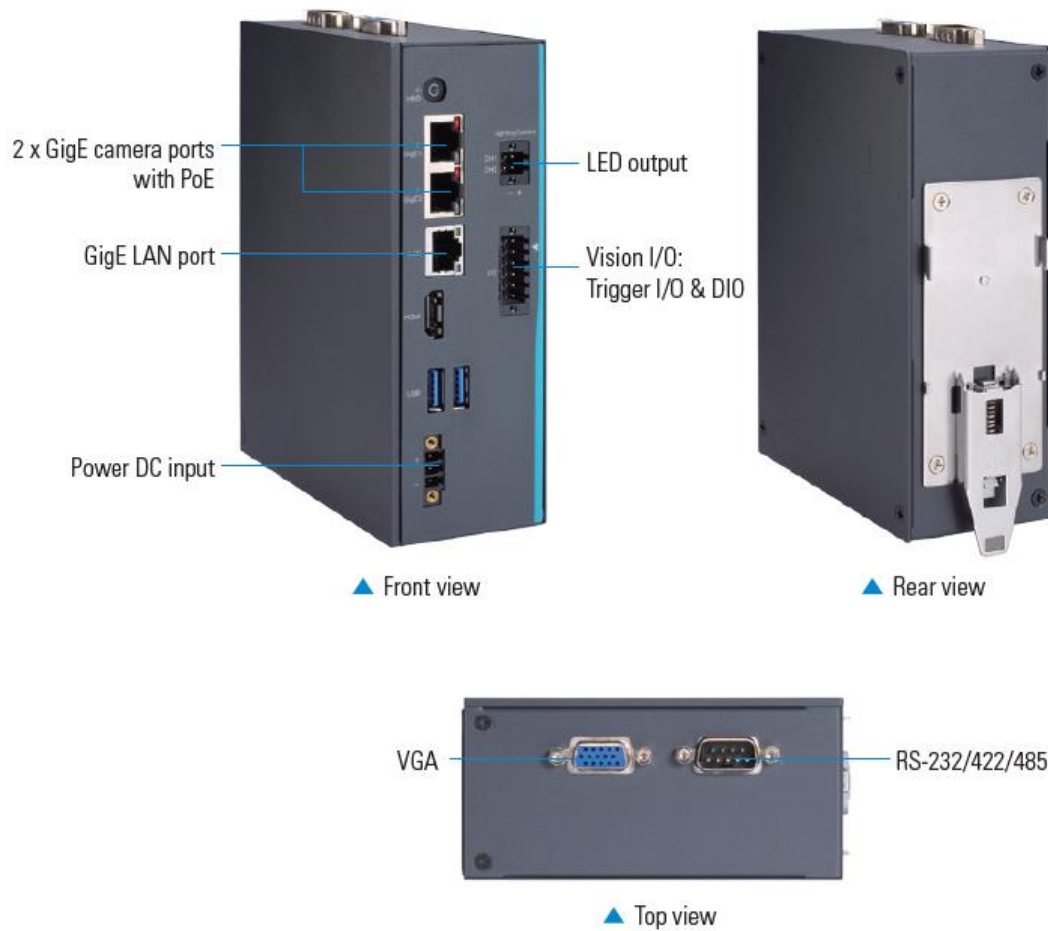

1.5 Packing List

The package bundled with your IMVS900 Series should contain the following items:

- **MVS100 unit x 1**
- **Screw pack x 1**
- **Terminal block x 3**
- **DIN-rail kit x 1**

If you cannot find this package or any items are missing, please contact Axiomtek distributor immediately.

1.6 Switch Settings & Wafer connector

Properly configure switch settings on the MVS100 to meet your application purpose. Below you can find a summary table of switch and onboard default settings.

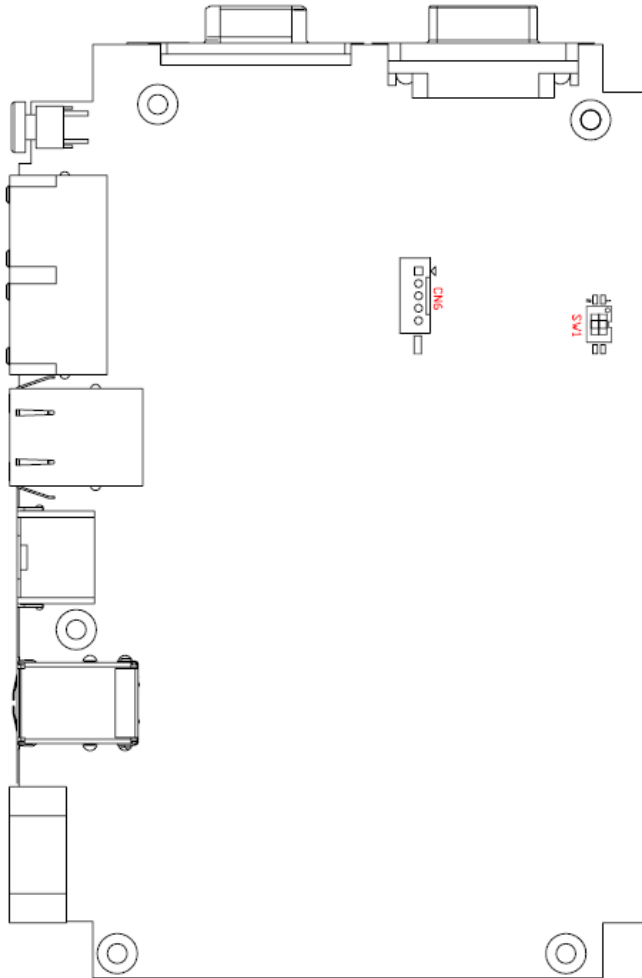

1.6.1 AT/ATX Mode & Clear CMOS Optimal Defaults (SW1)

If AT/ATX switch is set to AT mode, the system will be automatically powered on without pressing soft power button during power input; we can use this switch to achieve auto power on demand.

Set the switch to OFF for a few seconds then move it back to ON. Doing this procedure can clear BIOS optimal defaults.

Item	Function	Setting
1	ATX mode (default)	SW1 OFF
	AT mode	SW1 ON
2	Normal operation (default)	SW2 OFF
	Clear COMS	SW2 ON



1.6.2 Wafer Connector for optional USB dongle (CN6)

The wafer connector is used for the internal USB dongle.

1.7 Connectors

Connectors connect the board with other parts of the system. Loose or improper connection might cause problems. Make sure all connectors are properly and firmly connected.

Here is a table summarizing all connectors on the board.

Connector	Section
MINI Card slot for storage (mSATA signal)	1.7.1
LAN	1.7.2
USB 3.2 Gen1	1.7.3
VGA connector	1.7.4
DC-in power connector	1.7.5
HDMI connector	1.7.6
ATX Power on/off button	1.7.7
4-Pin terminal connector for LED lighting control	1.7.8
12-Pin terminal connector for vision I/O	1.7.9
COM x1 (RS232/422/485)	1.7.10
PD power indicator & GigE1/GigE2 connector (PoE function)	1.7.11

1.7.1 Mini Card Slot

The system has a PCI-Express Mini Card connector on the top side. It supports mSATA signals for storage.

Pins	Signals	Pins	Signals
1	No use	2	+3.3VSB
3	No use	4	GND
5	No use	6	+1.5V
7	No use	8	No use
9	GND	10	No use
11	No use	12	No use
13	No use	14	No use
15	GND	16	No use
17	No use	18	GND
19	No use	20	No use
21	GND	22	PERST#
23	SATA_RXP	24	+3.3VSB
25	SATA_RXN	26	GND
27	GND	28	+1.5V
29	GND	30	No use
31	SATA_TXN	32	No use
33	SATA_TXP	34	GND
35	GND	36	No use
37	GND	38	No use
39	+3.3VSB	40	GND
41	+3.3VSB	42	No use
43	GND	44	No use
45	No use	46	No use
47	No use	48	+1.5V
49	No use	50	GND
51	No use	52	+3.3VSB

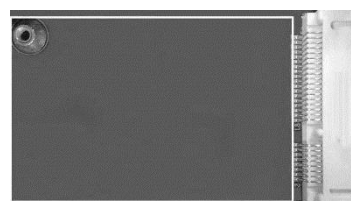
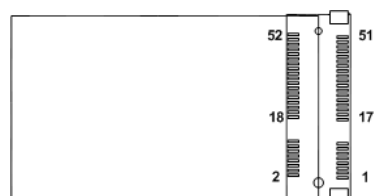

1.7.2 LAN

The system has one RJ-45 connector: LAN. Ethernet connection can be established by plugging one end of the Ethernet cable into this RJ-45 connector and the other end (phone jack) to a 1000/100/10-Base-T hub.

Pins	1000 Base-T	100/10 Base-T	Descriptions
L1	BI_DA+	TX+	Bidirectional or transmit data+
L2	BI_DA-	TX-	Bidirectional or transmit data-
L3	BI_DB+	RX+	Bidirectional or receive data+
L4	BI_DC+	N.C.	Bidirectional or not connected
L5	BI_DC-	N.C.	Bidirectional or not connected
L6	BI_DB-	RX-	Bidirectional or receive data-
L7	BI_DD+	N.C.	Bidirectional or not connected
L8	BI_DD-	N.C.	Bidirectional or not connected
A	Active link LED (Yellow) Off: No link Blinking: Data activity detected		
B	Speed LED 1000: Amber 100: Green 10: OFF		

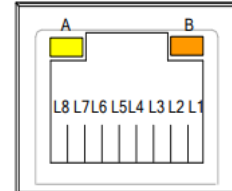

1.7.3 USB

The Universal Serial Bus connectors are compliant with USB 3.2 Gen 1 (5Gb/s), ideal for connecting USB peripherals to the system, such as scanners, cameras and USB devices, etc.

	Signal USB Port 0		Signal USB Port 1
1	VCC	10	VCC
2	D-	11	D-
3	D+	12	D+
4	GND	13	GND
5	SSRX0-	14	SSRX1-
6	SSRX0+	15	SSRX1+
7	GND	16	GND
8	SSTX0-	17	SSTX1-
9	SSTX0+	18	SSTX1+

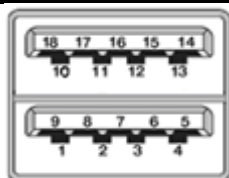

1.7.4 VGA Connector

The connector is a 15-pin D-Sub connector which is commonly used for a CRT monitor.

Pins	Signals	Pins	Signals
1	Red	2	Green
3	Blue	4	N.C.
5	GND	6	DETECT
7	GND	8	GND
9	+5V	10	GND
11	N.C.	12	DDC DATA
13	Horizontal Sync	14	Vertical Sync
15	DDC CLK		

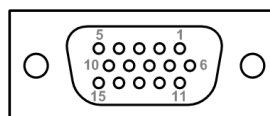

1.7.5 DC-in Power Connector

The system supports 24VDC DC-in connector for system power input.

Pins	Signals
1	DC+
2	GND
3	DC-

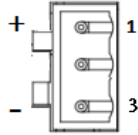

1.7.6 HDMI Connector

The HDMI (High-Definition Multimedia Interface) is a compact digital interface capable of transmitting high-definition video and high-resolution audio over a single cable.

Pins	Signals	Pins	Signals
1	HDMI OUT_DATA2+	11	GND
2	GND	12	HDMI OUT Clock-
3	HDMI OUT_DATA2-	13	N.C.
4	HDMI OUT_DATA1+	14	N.C.
5	GND	15	HDMI OUT_SCL
6	HDMI OUT_DATA1-	16	HDMI OUT_SDA
7	HDMI OUT_DATA0+	17	GND
8	GND	18	+5V
9	HDMI OUT_DATA0-	19	HDMI_HTPLG
10	HDMI OUT Clock+		

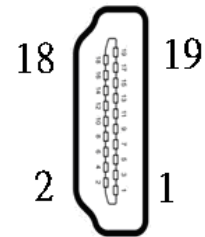

1.7.7 ATX Power On/OFF Button & HDD LED Indicate

The ATX power button is on the I/O side. It allows users to control MVS100 power on/off.

LED Name	Color	Description
Power	Orange	When power is active, the system is in standby mode.
	Blue	The system is in boot mode.
HDD	Orange	Storage status



1.7.8 4-Pin Terminal Connector for LED Lighting Control

The 4-pin terminal connector supports 2CH LED output for a variety of illumination needs.

Pin	Description	Pin	Description
1	LED1 +	3	LED1 -
2	LED2 +	4	LED2 -

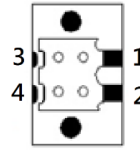

1.7.9 12-Pin Female I/O Connector

The 12-pin I/O connector has special I/O functions, including trigger I/O, DIO.

Pin	Description	Pin	Description
1	Trigger input COM	7	DI_COM
2	Trigger input 0/ DI 2	8	DI 0
3	Trigger input 1/ DI 3	9	DI 1
4	Trigger output 0/ DO 2	10	DO 0
5	Trigger output 1/ DO 3	11	DO 1
6	L_GND	12	L_GND

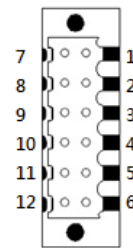

1.7.10 COM

The system has one serial port for peripheral communication.

- 1 port DB9 support RS-232/422/485 which can be selected by BIOS.
- Supports auto flow control in RS485 mode.
- Supports high speed mode 115.2 Kbps, up to 1.5 Mbps

Pins	RS-232	RS-422	RS-485
1	DCD, Data Carrier Detect	TX-	Data-
2	RXD, Receive Data	TX+	Data+
3	TXD, Transmit Data	RX+	No use
4	DTR, Data Terminal Ready	RX-	No use
5	GND, Ground	GND, Ground	No use
6	DSR, Data Set Ready	No use	No use
7	RTS, Request to Send	No use	No use
8	CTS, Clear to Send	No use	No use
9	No use	No use	No use

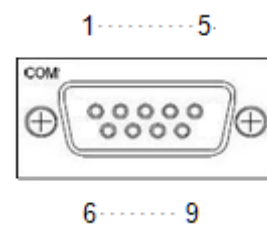

1.7.11 PD Power Indicator & GigE1 ~ GigE2 ports

The system has two camera interfaces with PoE functions for connecting industrial cameras.

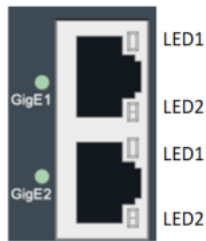

PD Power Indicator

When a GigE port is currently active, its corresponding PD power indicator will light up.

Pin	Signal
GigE1	CAM Port1
GigE2	CAM Port2

GigE1 ~ GigE2 Ports

Pin	Description
LED1	Active LED: Amber Off: No link Blinking: Data activity detected
LED2	Link LED (10: OFF; 100-Green; 1000-Amber)

This page is intentionally left blank.

Section 2

Hardware Installation

The MVS100 is convenient for your various hardware configurations, including the memory module and PCI Express card module (mSATA for storage). Section 2 will show you how to install the hardware.

2.1 Installing the Memory Module

- Step 1** Turn off the system.
- Step 2** Disconnect the power connector.
- Step 3** Turn the system over to the left side to locate and unscrew the four screws. Then remove the cover.



- Step 4** Install the SO-DIMM (small outline dual in-line memory module) into the socket and push it firmly down until it is fully seated. The socket latches are clipped on to the edges of the memory module.



- Step 5** After installing the memory modules, close the cover back onto the system and fasten all screws.

2.2 Installing the PCI Express Mini Card

The MVS100-323-FL provides a PCI Express Mini Card slot for storage.

- Step 1** Turn off the system.
- Step 2** Disconnect the power connector.
- Step 3** Turn the system over to the left side to locate and unscrew the four screws. Then remove the cover.



- Step 4** After removing the cover, locate the PCI Express Mini Card slot on the board.

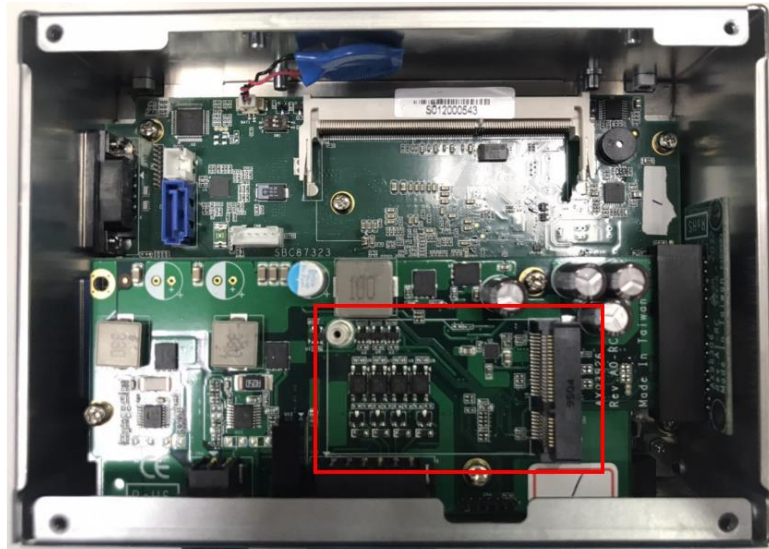

- Step 5** Hold the mSATA storage at 30 degrees up from the horizontal direction and inset the golden finger into the slot until it is fully inserted.

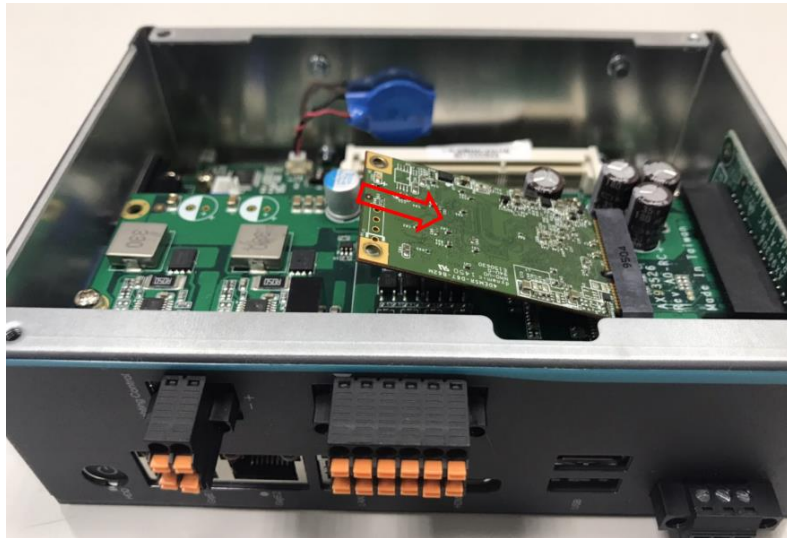

- Step 6** Fix the mSATA storage onto the board with one screw.

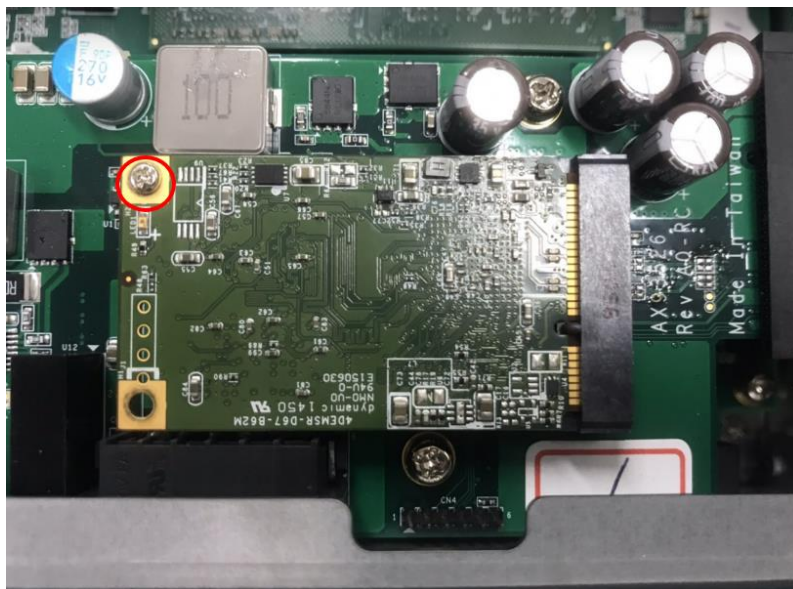

2.3 Installing an internal USB dongle (Option)

The MVS100 supports an internal USB2.0 slot for installing a software dongle.

- Step 1** Turn off the system.
- Step 2** Disconnect the power connector.
- Step 3** Turn the system over to the left side to locate and unscrew the screws; then open the cover.



- Step 4** Insert the USB dongle into the holder attached to the system chassis.



2.4 Installing Dail-rail mounting

The MVS100-323-FI provides DIN-rail Mount for installing as below:

Step 1 Prepare the DIN-rail mount kit ready, including the screws and bracket.



Step 2 Install the bracket and fasten all screws tight, as illustrated below.



2.5 Wall-mount bracket kit (Option)

Get the four truss head M4*6L screws from the optional wall-mount kit to fix the wall-mount kit.

Step 1 Prepare the wall-mount kit ready, including screws and bracket.



Step 2 Install the bracket and fasten all screws tight.



Dimensions

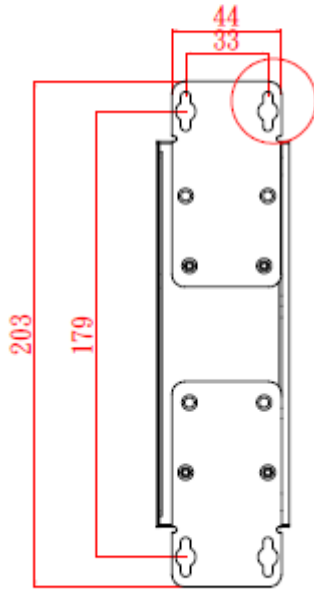
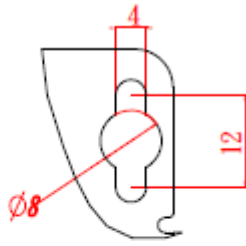

This page is intentionally left blank.

Section 3

I/O Connection

3.1 I/O Connection (12-pin terminal connector)

Refer to this section to connect any cables between the system and other devices. Each of the following I/O figures illustrates their respective connection on the MVS100.



3.1.1 Isolated Digital Input & Trigger Input

The figure shows how to connect an external input source to the system. Each of the isolated digital and trigger input channels accepts dry contact and wet contact 0~30 VDC with sink type and source type.

Dry contact:

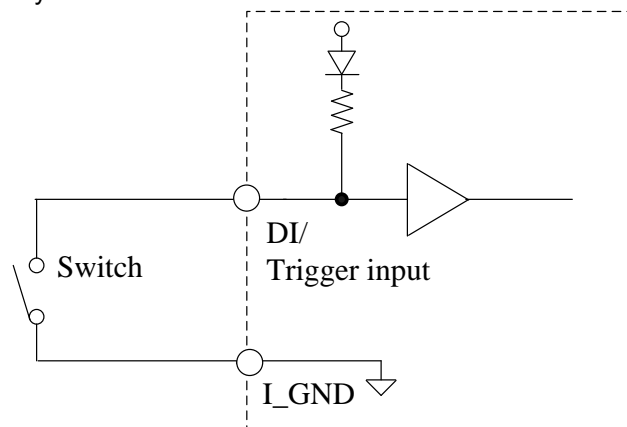

Wet contact:

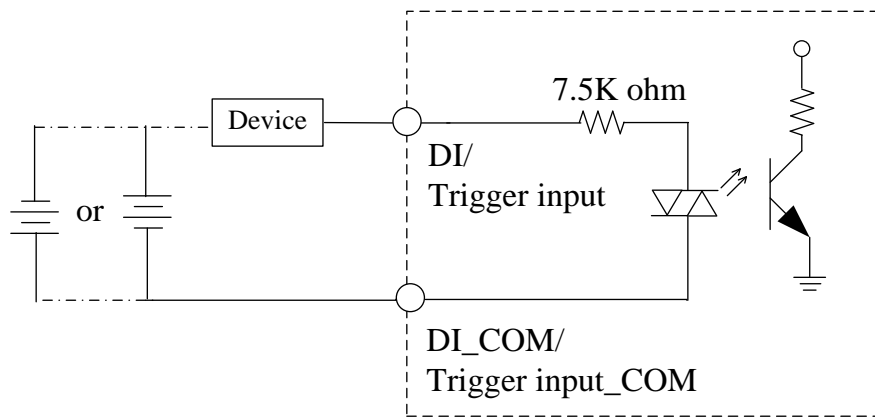

3.1.2 Isolated Digital Output & Trigger Output

The figure shows how to connect an output channel to the system.

If an external voltage of 5~30 VDC is applied to an isolated digital or trigger output channel, the current will flow from the external voltage source to the system.

Please note that the current through each DO channel should not exceed 100 mA.

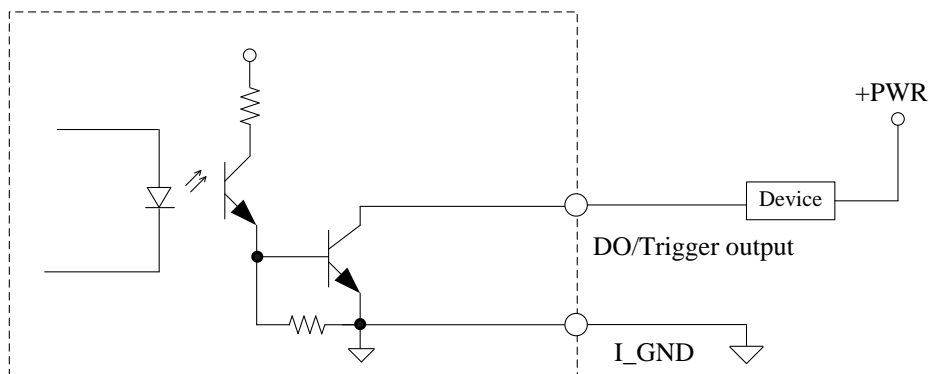

3.2 I/O Connection (4-pin terminal connector)

The system offers 2 ports for LED output, as shown by the red box in the figure below. Refer to this section to connect any cables between the lighting control output and other LEDs.



3.2.1 LED Lighting Control

The figure shows how to connect external LEDs to the system. Each of the LED output channels supports 12/24VDC up to 500mA in strobe mode.

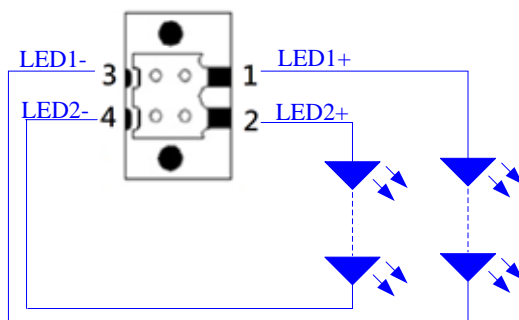

This page is intentionally left blank.

Section 4

Operating

4.1 Operating

This section describes the operation of the MVS100 in detail.

4.1.1 Trigger Input/ Output

Trigger input supports de-bounce filter function to help filter out environmental noise. The de-bounce filter defines the interval width for high/low signals. Signals of interval width less than the defined value will be filtered out.

Below is a diagram illustrating the case of filter timer set with a duration time of 1 millisecond:

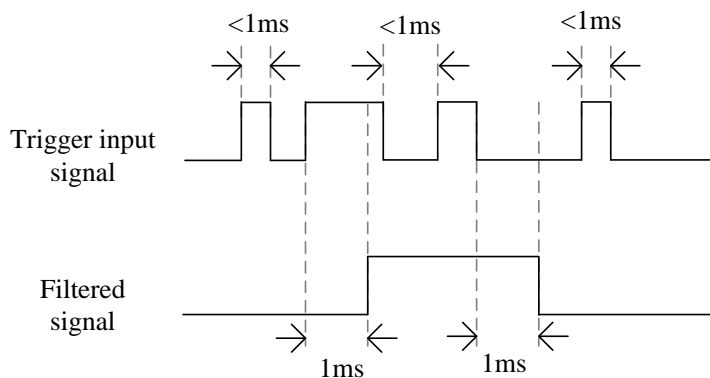

Trigger Output CH 0~1 provides the following parameters to configure:

- **Trigger source**
The user can select any of the following items as a triggering condition that prompts the MVS100 to generate a trigger output: Trigger Input CH 0~1.
Note: One trigger source can be set to activate multiple trigger outputs.
- **Delay time function**
The user can set the delay time that the system waits before it sends a trigger output.
- **Duration time**
The user can adjust pulse width for the output signal.
(Definitions of delay time and duration time are illustrated below):

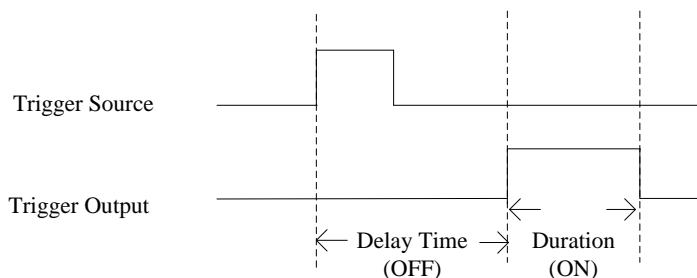

■ **Invert**

Trigger source mode can be set as rising trigger or falling trigger.

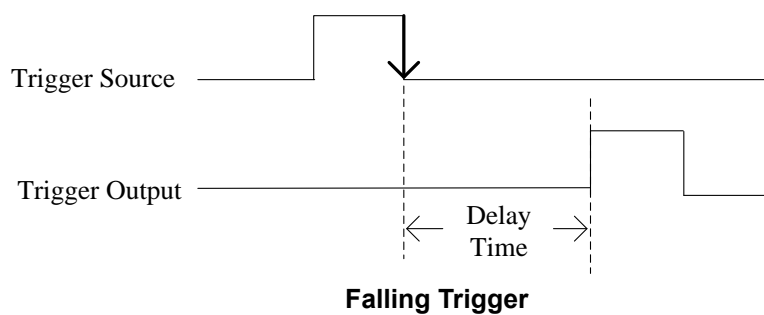
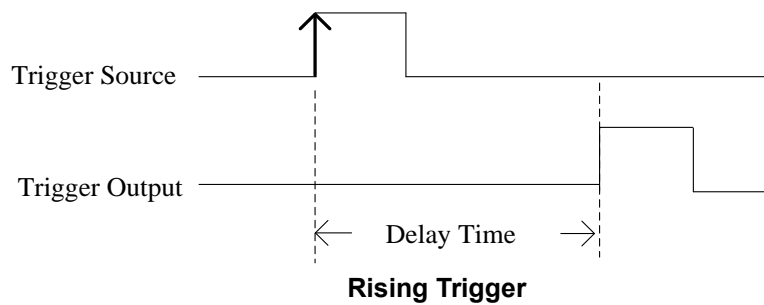

4.1.2 LED Lighting Control

LED lighting output can be set to use continuous, trigger or strobe mode. Also, based on a variety of conditions, trigger LED output, duration time, delay time and dimming control can be programmed to help identify object characteristics and meet high image requirements in different inspections.

4.1.3 Interrupt

This function can be used to send an interrupt signal to the host PC.

The user can select two conditions for the MVS100 to generate an interrupt signal.

4.2 Application

This section shows a real use case in the machine vision field.

4.2.1 Scenario

In this scenario, when an optical sensor detects objects passing down the production line, it will send trigger signals to notify the system. These signals trigger a camera to capture images. Data from the camera is then used by a vision platform to identify features. Finally, should an object with defects be detected, it is rejected by a pneumatic actuator or robotic arm. These functions will provide real-time I/O with microsecond-scale control and lighting control to meet timing sequence requirements and ensure high quality image output.

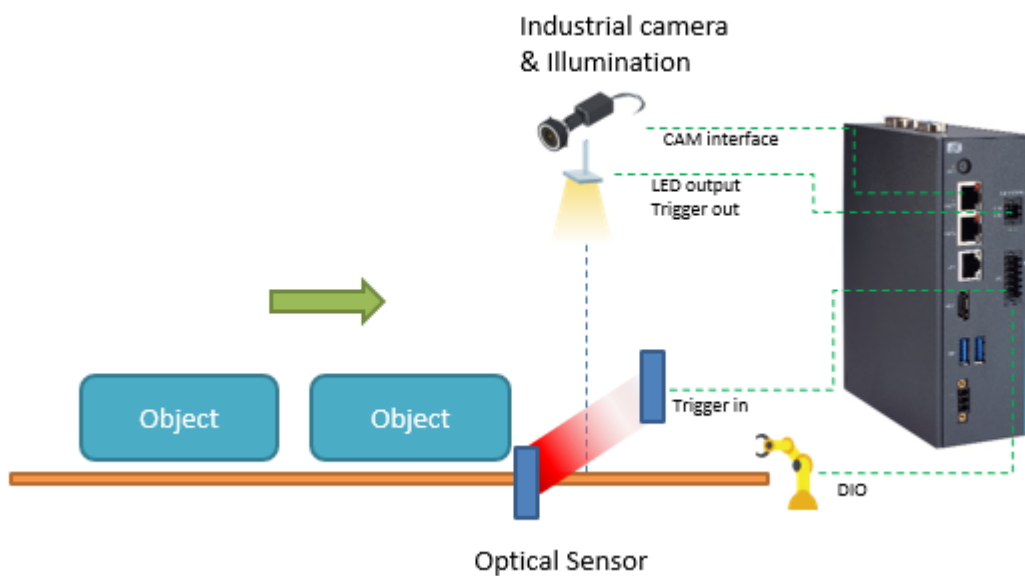

This page is intentionally left blank.

Section 5

AMI BIOS Utility

The AMI UEFI BIOS provides users with a built-in setup program to modify basic system configuration. All configured parameters are stored in a 16MB flash chip to save the setup information whenever the power is turned off. This chapter provides users with detailed description about how to set up basic system configuration through the AMI BIOS setup utility.

5.1 Setting

To enter the setup screens, follow the steps below:

1. Turn on the computer and press the key immediately.
2. After you press the key, the main BIOS setup menu displays. You can access the other setup screens from the main BIOS setup menu, such as the Advanced and Chipset menus.



Note: *If your computer cannot boot after making and saving system changes with Setup, you can restore BIOS optimal defaults by setting JP1 (see section 1.7.1).*

It is strongly recommended that you should avoid changing the chipset's defaults. Both AMI and your system manufacturer have carefully set up these defaults that provide the best performance and reliability.

5.2 Navigation Keys

The BIOS setup/utility uses a key-based navigation system called hot keys. Most of the BIOS setup utility hot keys can be used at any time during the setup navigation process. These keys include <F1>, <F2>, <Enter>, <ESC>, <Arrow> keys, and so on.



Note: *Some of the navigation keys differ from one screen to another.*

Hot Keys	Description
→← Left/Right	The Left and Right <Arrow> keys allow you to select a setup screen.
↑↓ Up/Down	The Up and Down <Arrow> keys allow you to select a setup screen or sub-screen.
+– Plus/Minus	The Plus and Minus <Arrow> keys allow you to change the field value of a particular setup item.
Tab	The <Tab> key allows you to select setup fields.
F1	The <F1> key allows you to display the General Help screen.
F2	The <F2> key allows you to Load Previous Values.
F3	The <F3> key allows you to Load Optimized Defaults.
F4	The <F4> key allows you to save any changes you have made and exit Setup. Press the <F4> key to save your changes.
Esc	The <Esc> key allows you to discard any changes you have made and exit the Setup. Press the <Esc> key to exit the setup without saving your changes.
Enter	The <Enter> key allows you to display or change the setup option listed for a particular setup item. The <Enter> key can also allow you to display the setup sub- screens.

5.3 Main Menu

The first time you enter the setup utility, you will be in the Main setup screen. You can return to the Main setup screen by selecting the Main tab. System Time/Date can be set up as described below. The Main BIOS setup screen is shown below.

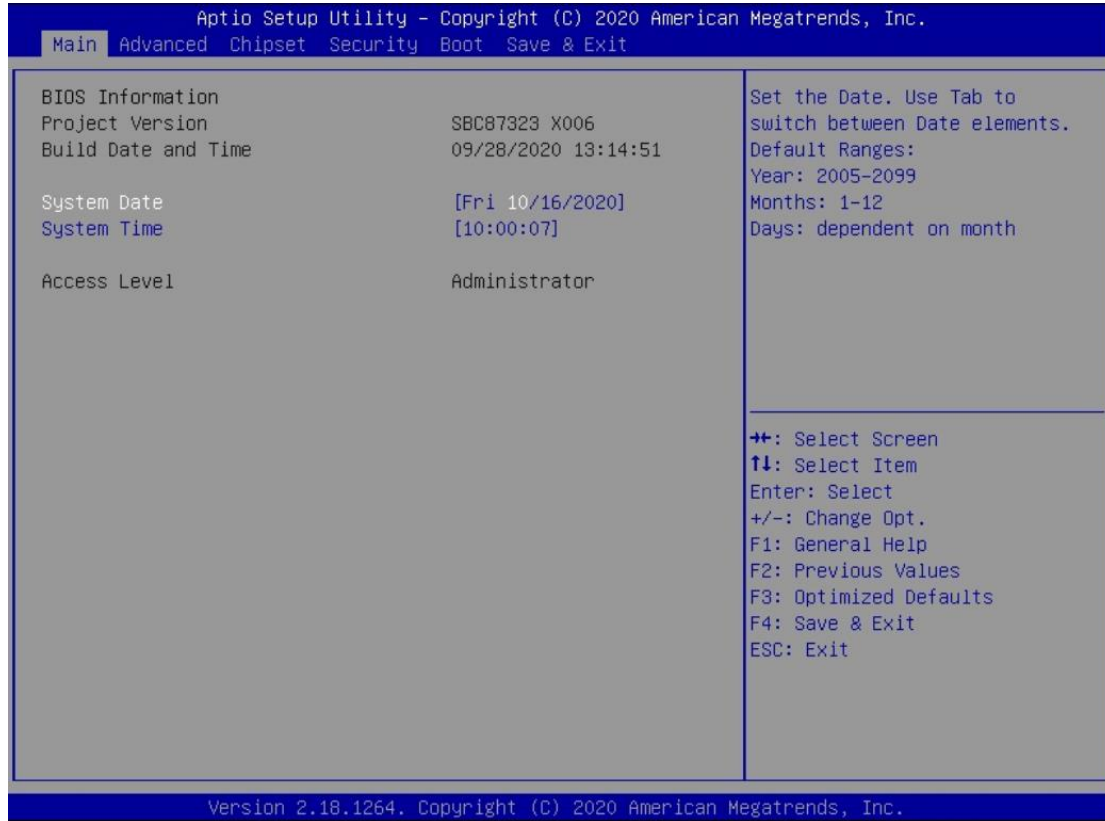

➤ System Date/Time

Use this option to change the system time and date. Highlight System Time or System Date using the <Arrow> keys. Enter new values through the keyboard. Press the <Tab> key or the <Arrow> keys to move between fields. The date must be entered in MM/DD/YY format. The time is entered in HH:MM:SS format.

5.4 Advanced Menu

The Advanced menu also allows users to set configuration of the CPU and other system devices. You can select any of the items in the left frame of the screen to go to the sub menus:

- ▶ ACPI Settings
- ▶ Trusted Computing
- ▶ CPU Configuration
- ▶ F81804 Super IO Configuration
- ▶ Hardware Monitor
- ▶ SATA Configuration
- ▶ USB Configuration
- ▶ PoE Configuration

For items marked with “▶”, press <Enter> for more options.

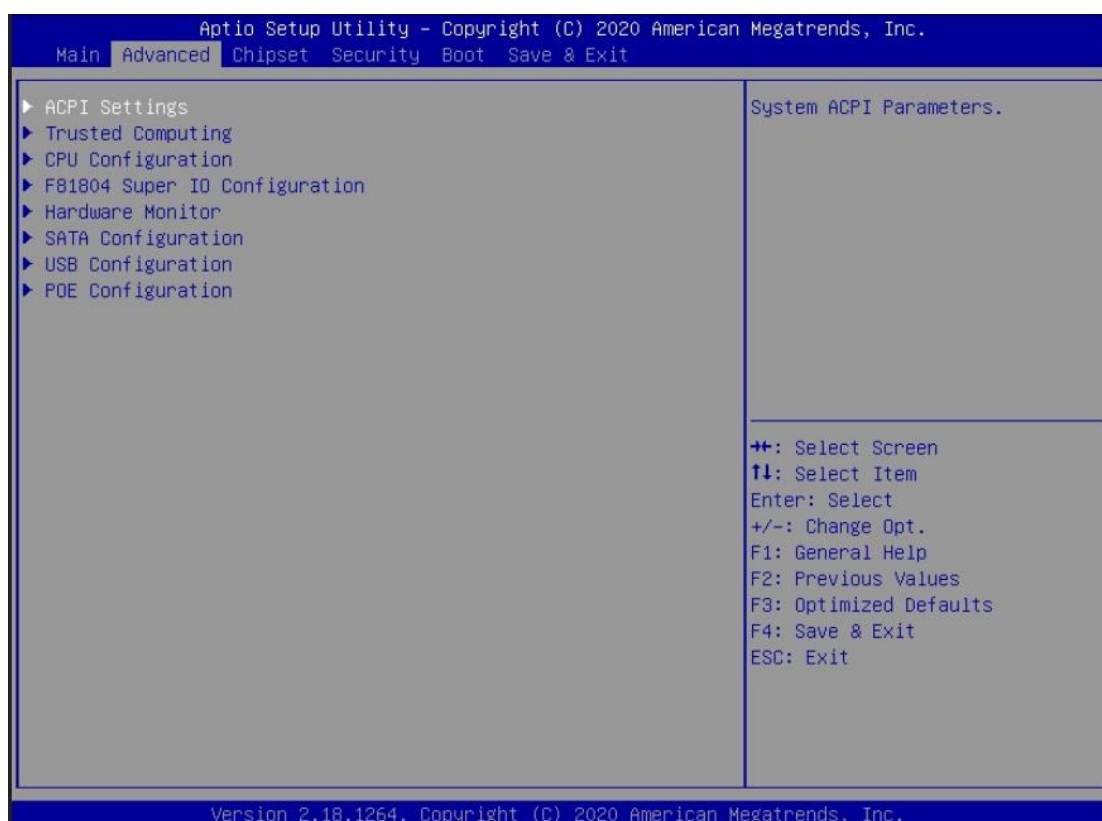

- **ACPI Sleep State**

Select the ACPI (Advanced Configuration and Power Interface) sleep state. Configuration options are Suspend Disabled and S3 (Suspend to RAM). The S3 option selects ACPI sleep state the system will enter when suspend button is pressed.

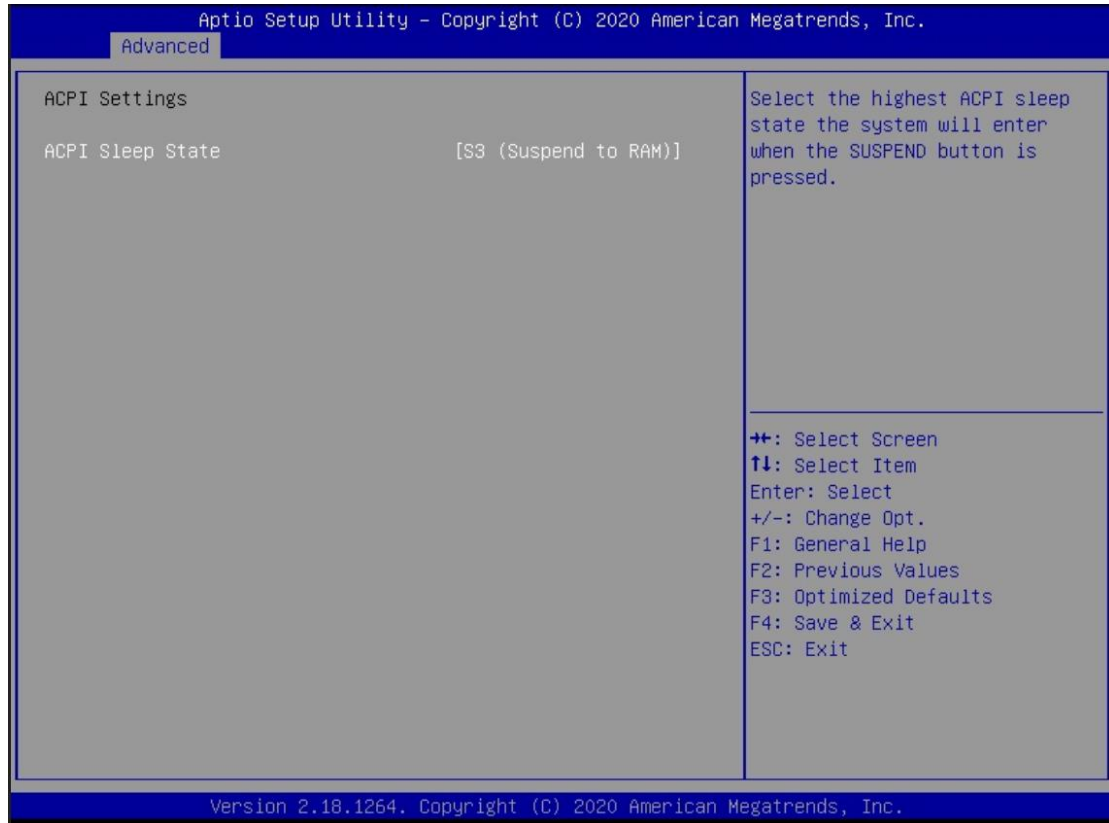

- **Trusted Computing**

Select the Security Device Support to enable or disable the TPM function.

Aptio Setup Utility - Copyright (C) 2020 American Megatrends, Inc.		
Advanced		
TPM20 Device Found		Enables or Disables BIOS support for security device. O.S. will not show Security Device. TCG EFI protocol and INT1A interface will not be available.
Firmware Version:	73.4	
Vendor:	STM	
Security Device Support	[Enable]	
Active PCR banks	SHA-1,SHA256	
Available PCR banks	SHA-1,SHA256	
SHA-1 PCR Bank	[Enabled]	
SHA256 PCR Bank	[Enabled]	
Pending operation	[None]	
Platform Hierarchy	[Enabled]	
Storage Hierarchy	[Enabled]	
Endorsement Hierarchy	[Enabled]	
TPM2.0 UEFI Spec Version	[TCG_2]	
Physical Presence Spec Version	[1.3]	
TPM 20 InterfaceType	[TIS]	
Device Select	[Auto]	
Disable Block Sid	[Disabled]	
		++: Select Screen ↑↓: Select Item Enter: Select +/-: Change Opt. F1: General Help F2: Previous Values F3: Optimized Defaults F4: Save & Exit ESC: Exit
Version 2.18.1264. Copyright (C) 2020 American Megatrends, Inc.		

- **CPU Configuration**

This screen shows the CPU version and detailed information.

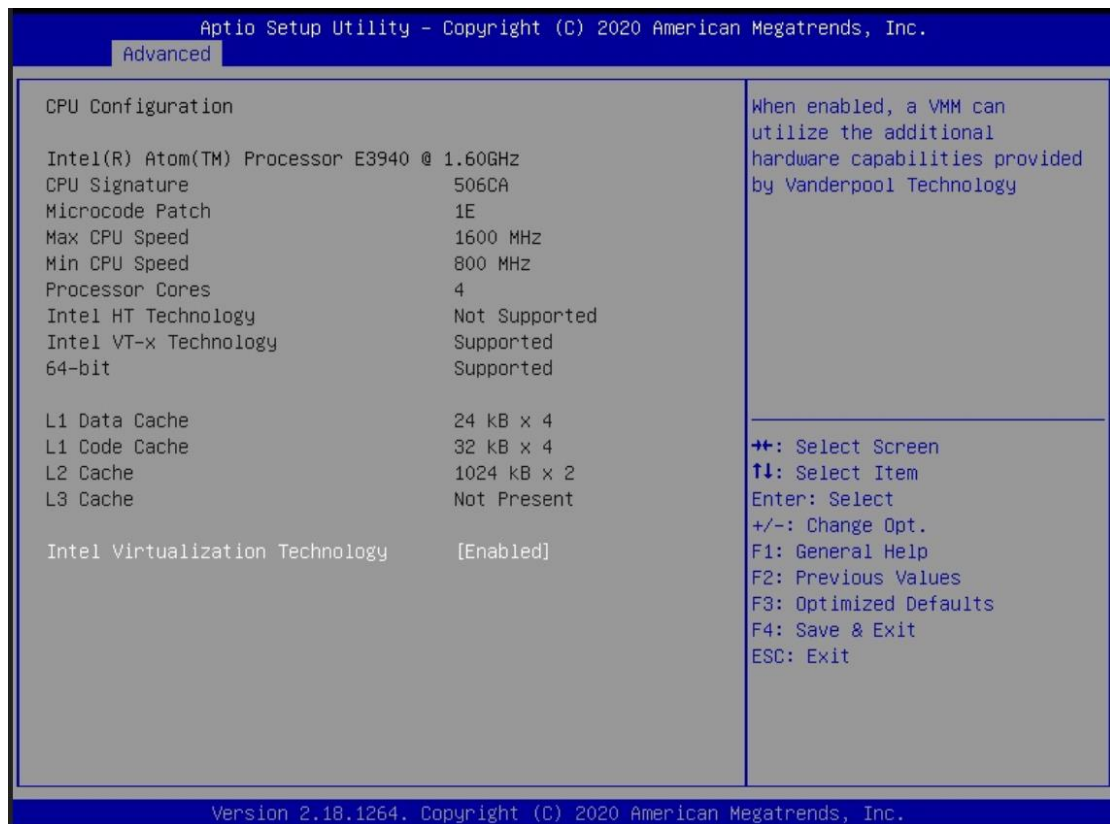

- **Intel Virtualization Technology**

This item allows a hardware platform to run multiple operating systems separately and simultaneously, enabling one system to virtually function as several systems.

- **F81804 Super IO Configuration**

Use this screen to select options for the F81804 Super I/O configuration and change the value of the selected option. A description of selected item appears on the right side of the screen.

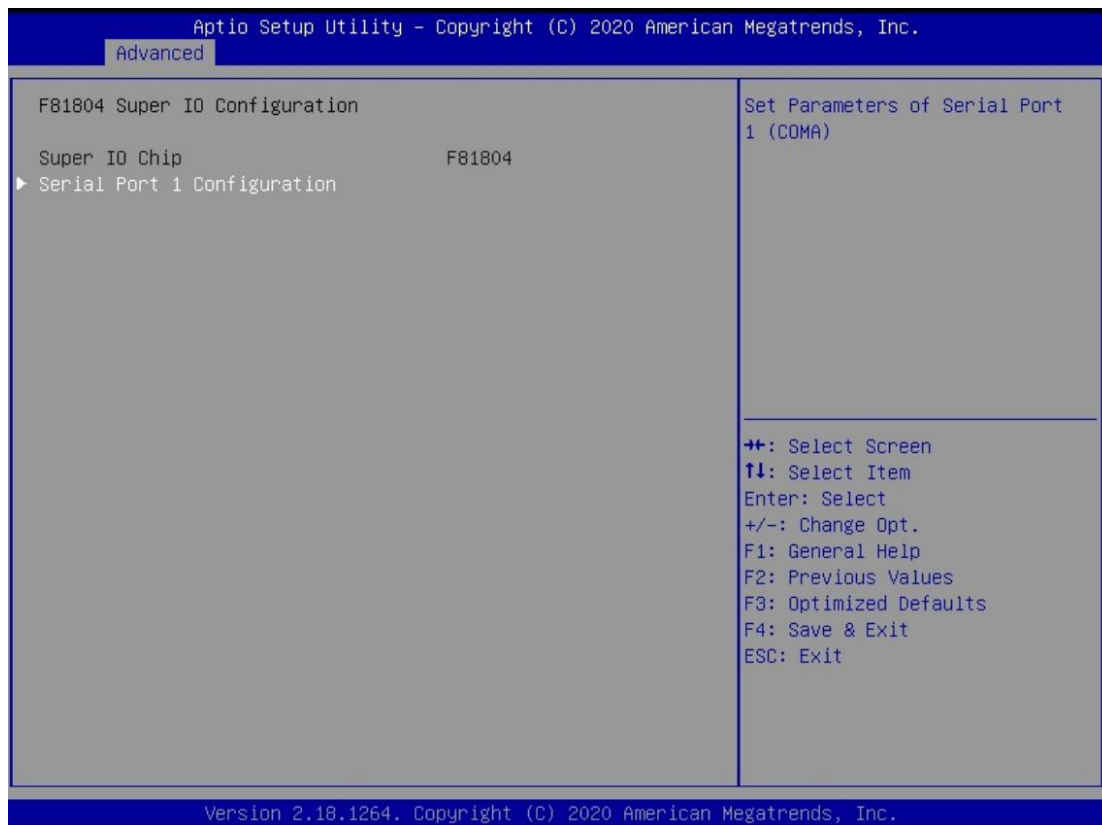

- ▶ **Serial Port 1 Configuration**

Use these items to set parameter related to serial port 1.

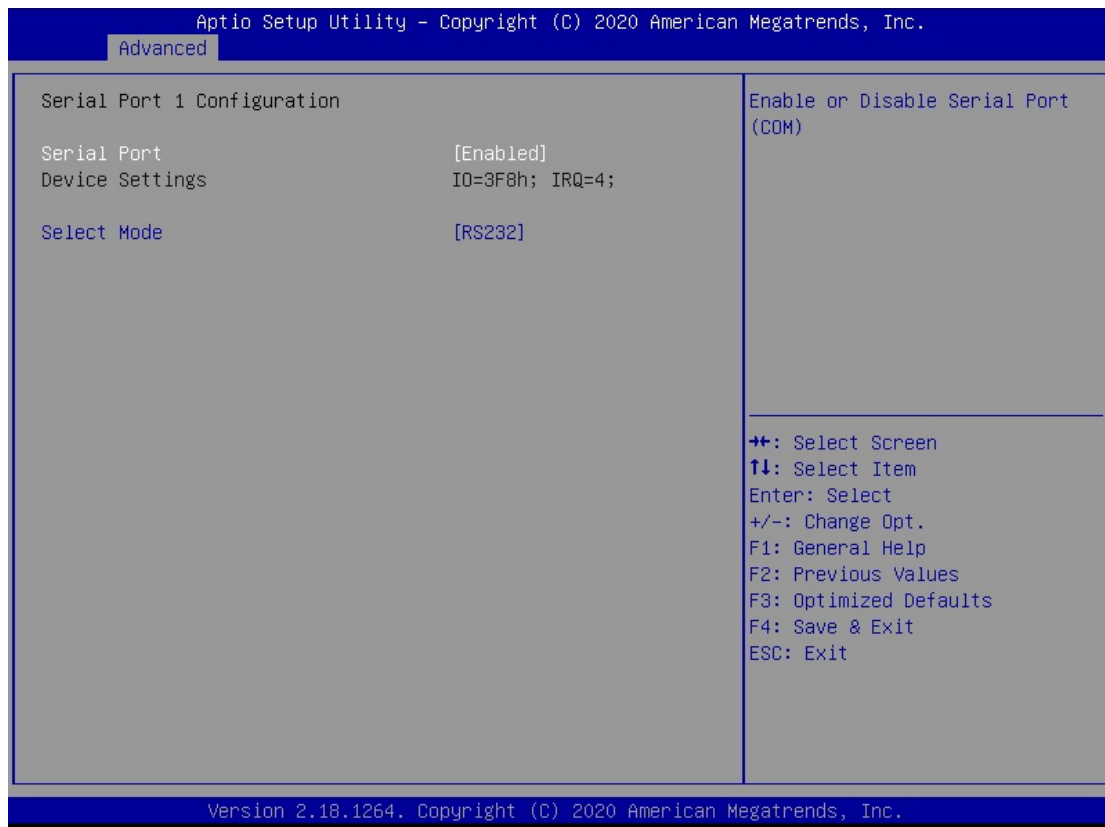

➤ **Select Mode**

The default setting for Serial Port is RS-232 and this option also supports other settings, including RS-422 and RS-485.

- **Hardware Monitor**

This screen displays hardware health.

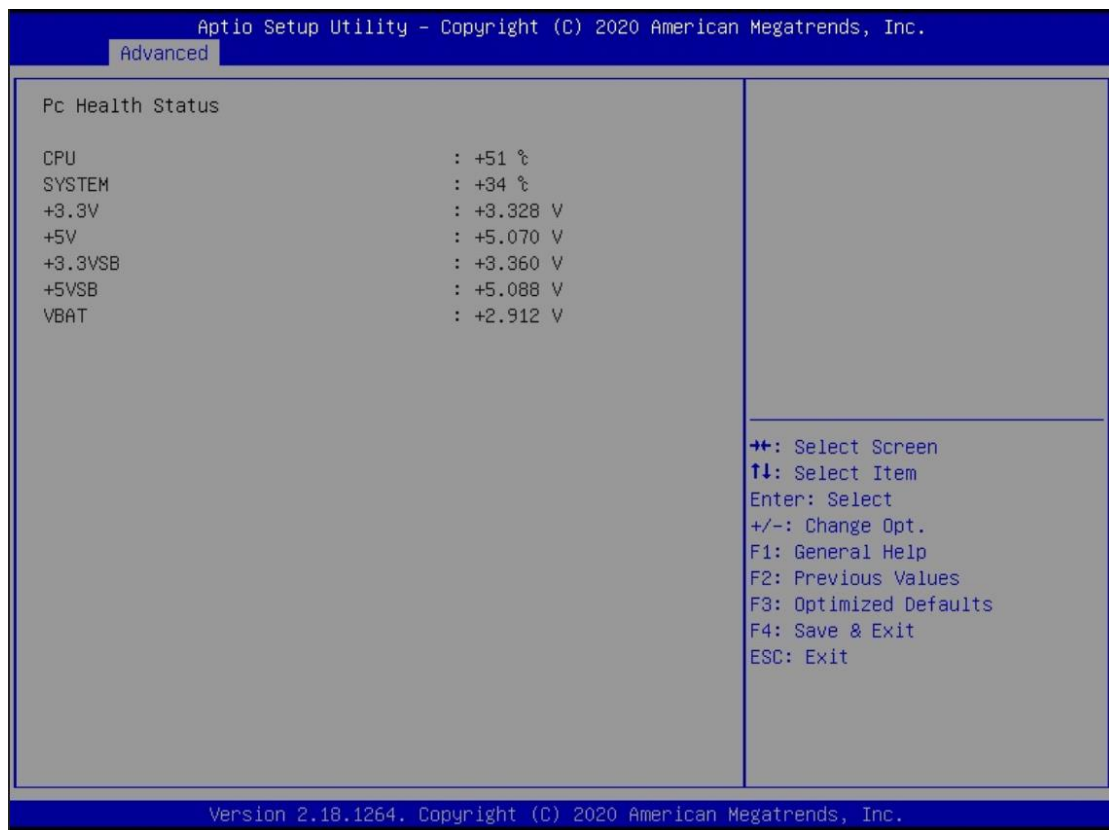

- **SATA Configuration**

This item allows the user to read the currently installed hardware configurations for the SATA ports shown in the SATA Configuration menu. During system bootup, BIOS will detect the present SATA devices automatically.



- **Chipset SATA**

Enable or disable the SATA Controller feature. The default is Enabled.

- **USB Configuration**

USB configuration can be configured here by selecting and changing each item. A description of the selected item appears on the right side of the screen.

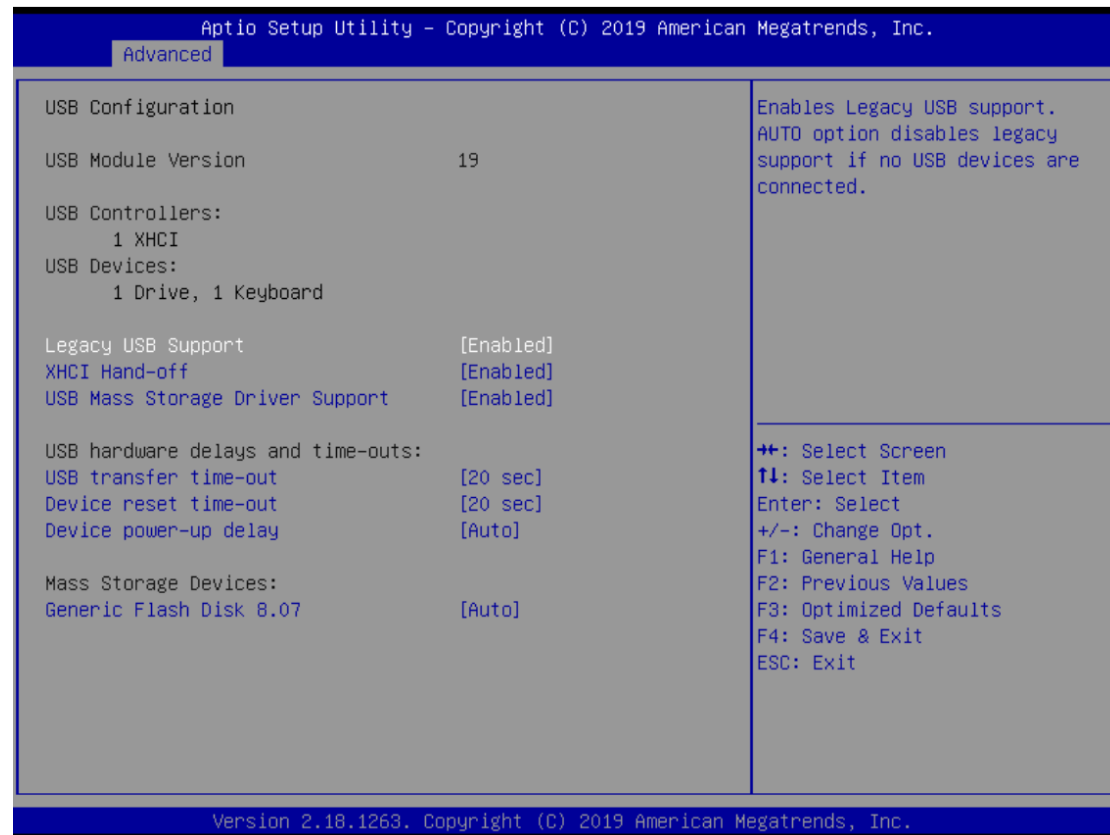

- **Legacy USB Support**
Enables Legacy USB support. The AUTO option disables legacy support if no USB devices are connected.
- **XHCI Hand-off**
This is a workaround for OSeS without XHCI hand-off support. The XHCI ownership change should be claimed by XHCI driver.
- **USB Mass Storage Driver Support**
Enables/Disables USB Mass Storage Driver Support.
- **USB transfer time-out**
The time-out value for Control, Bulk, and Interrupt transfers.
- **Device reset time-out**
USB mass storage device Start Unit command time-out.
- **Device power-up delay**
Maximum time the device will take before it properly reports itself to the Host Controller. 'Auto' uses default value: for a Root port it is 100 ms, for a Hub port the delay is taken from Hub descriptor.

- **PoE Configuration**

The MVS100 provides two GbE ports with PoE function. PoE configuration can be set here by selecting and changing each item, including power budget setting, power status monitoring and each port on/off control. A description of the selected item appears on the right side of the screen.

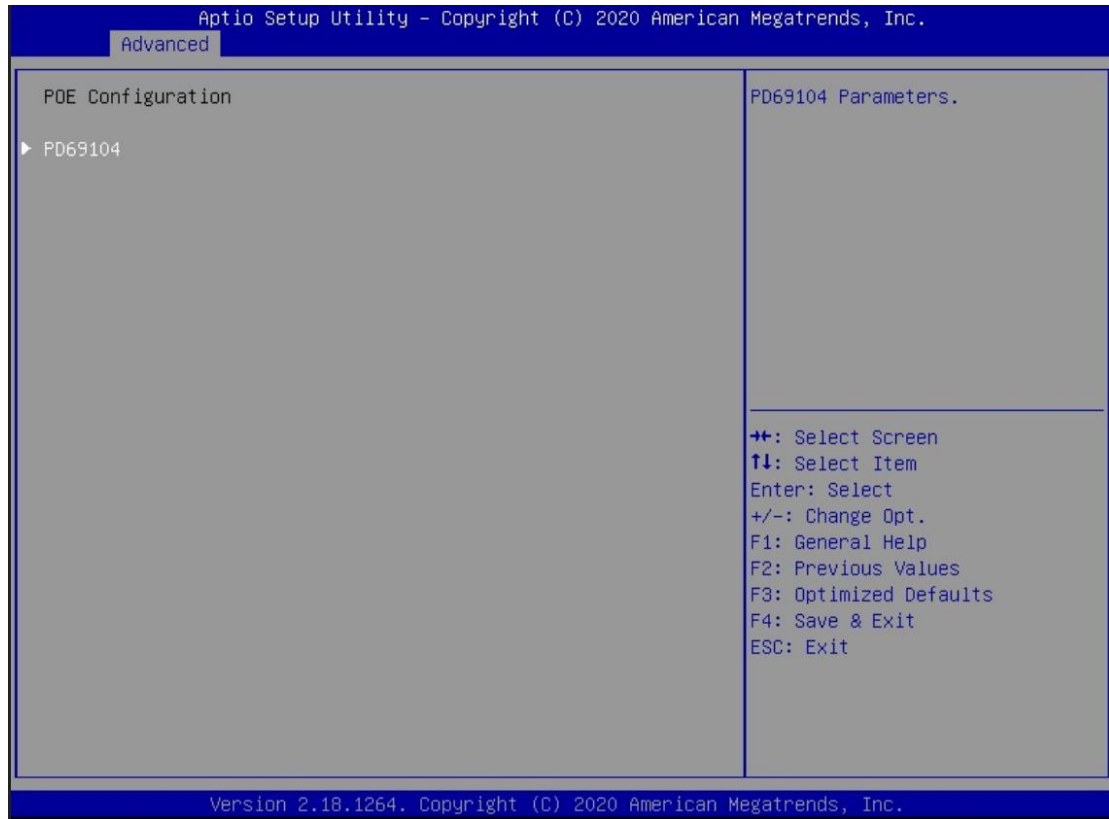



This screen displays independent power budget setting per port and PoE power consumption.

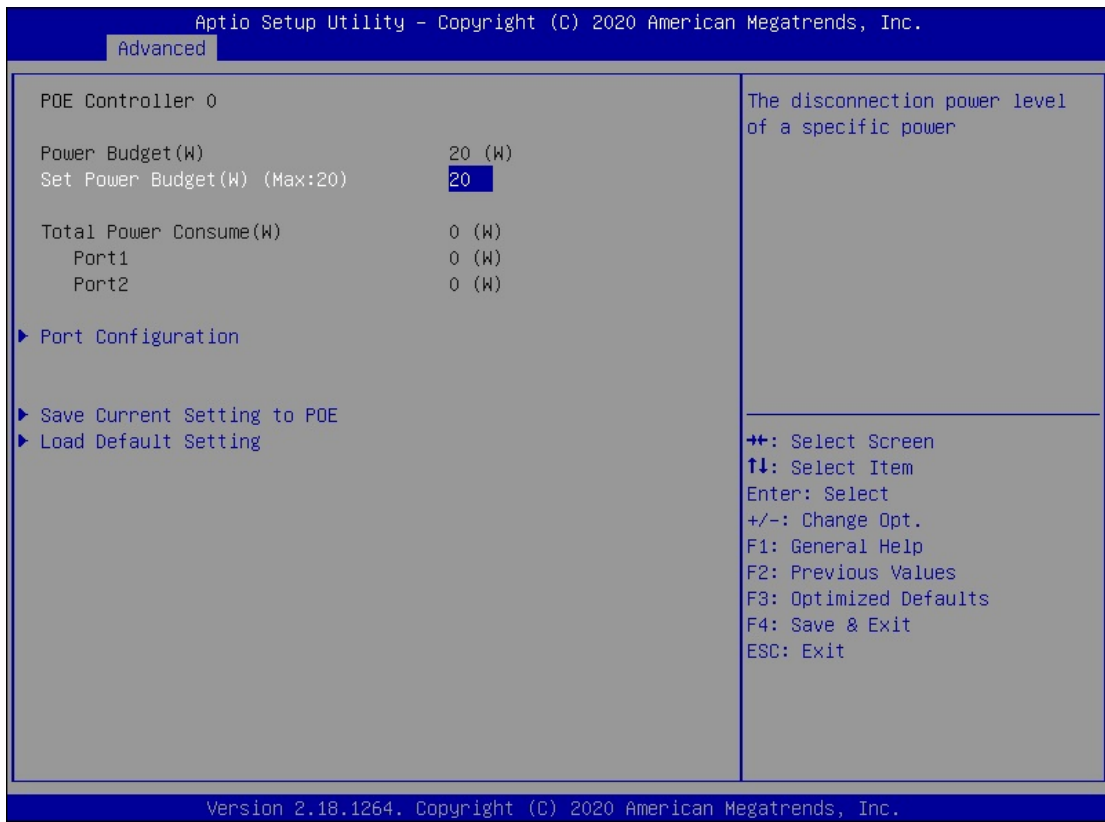

This screen shows each port's on/off control settings and allows the user to monitor PoE connection status.

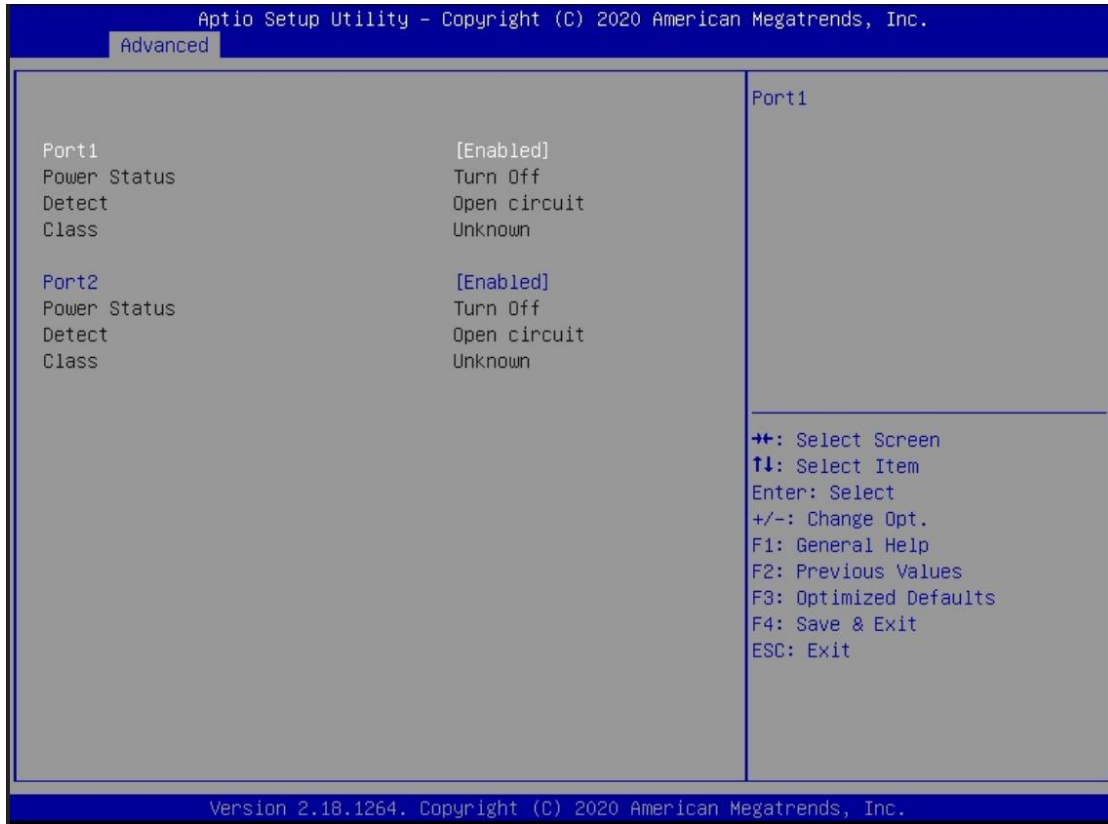

5.5 Chipset

This screen shows memory information.

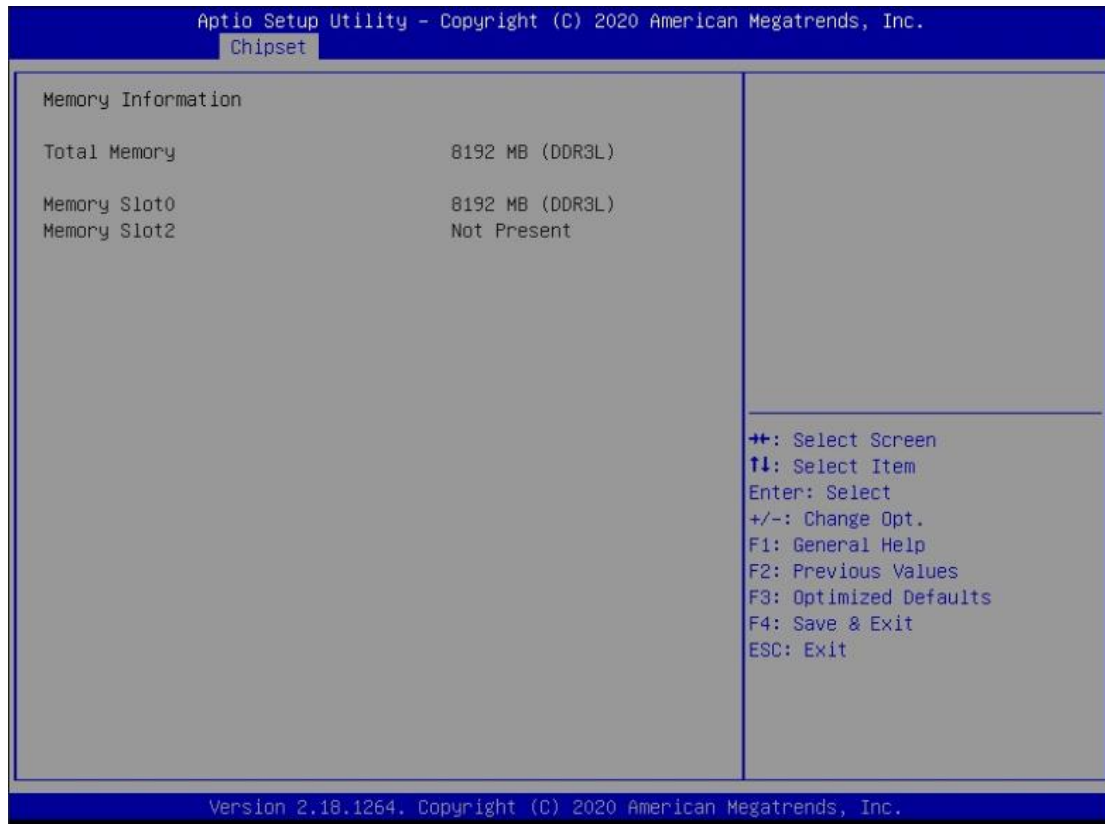

5.6 Security Menu

The Security menu allows users to change the security settings for the system.

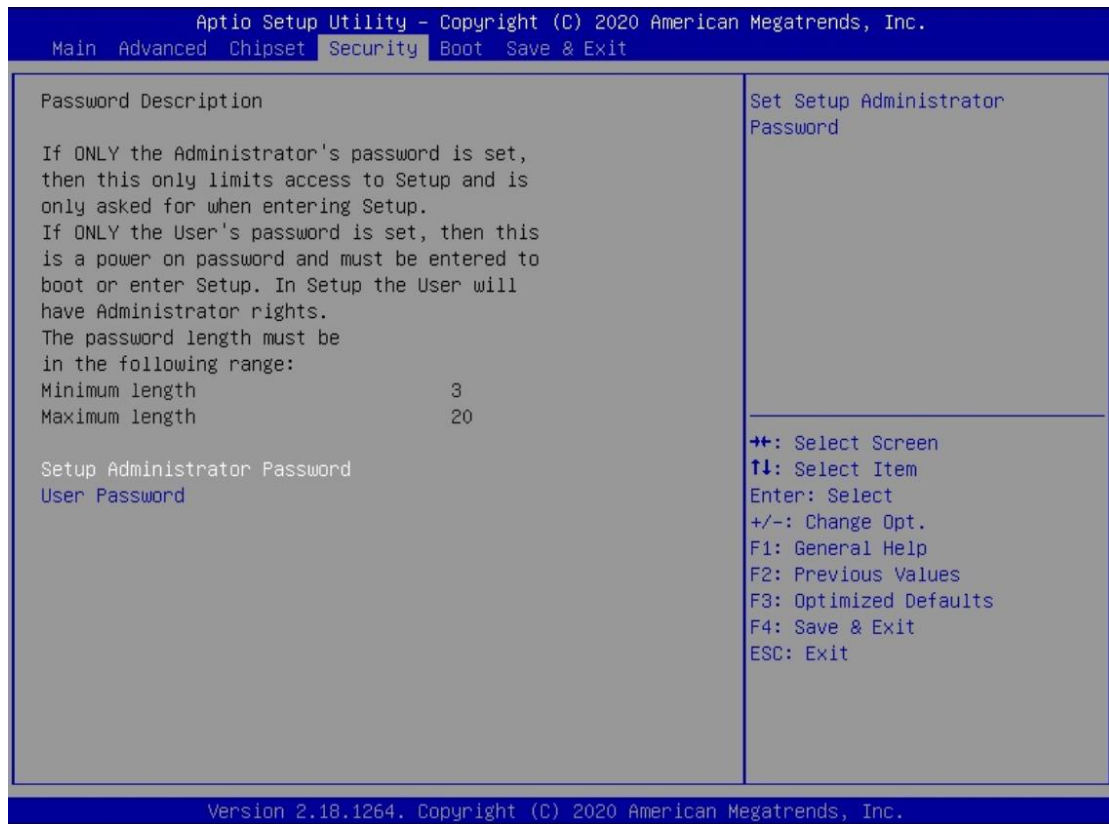

➤ Administrator Password

This item indicates whether an administrator password has been set (installed or uninstalled).

➤ User Password

This item indicates whether a user password has been set (installed or uninstalled).

5.7 Boot Menu

The Boot menu allows users to change boot options of the system.

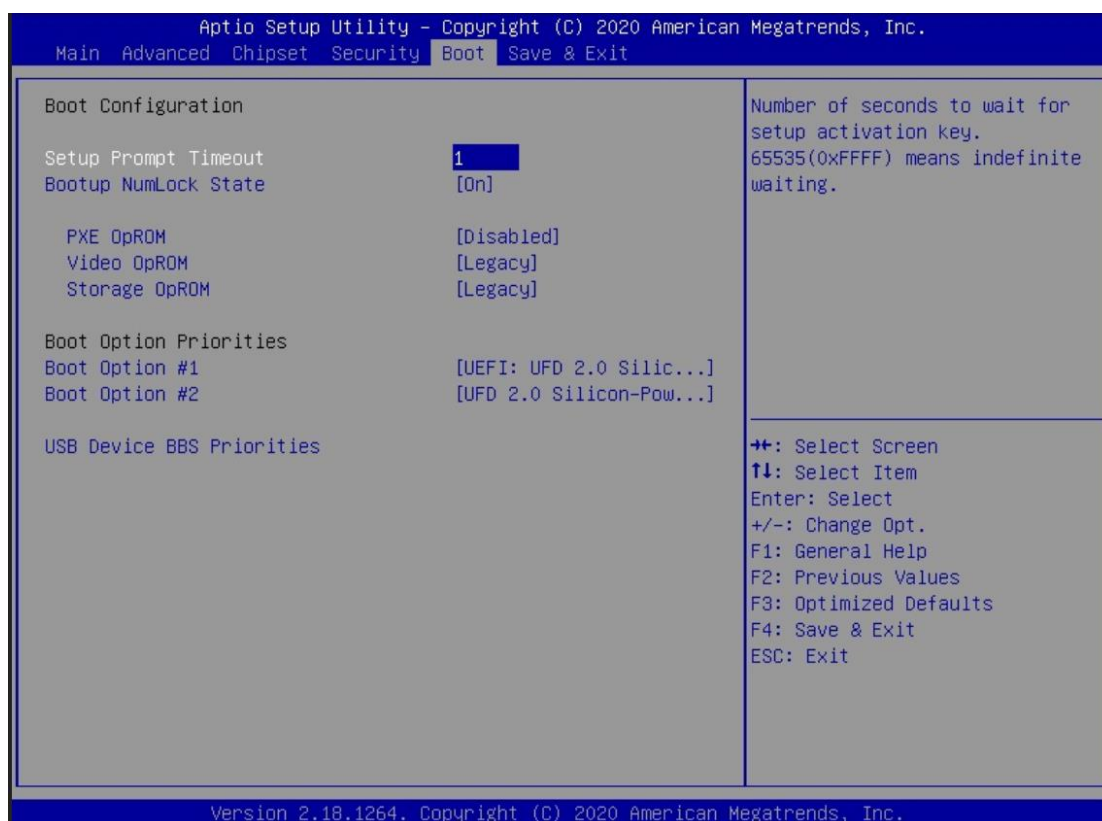

- **Setup Prompt Timeout**
Number of seconds to wait for setup activation key. 65535(0xFFFF) means indefinite waiting.
- **Bootup NumLock State**
Use this item to select the power-on state for the keyboard NumLock.
- **Boot Option Priorities**
These are settings for boot priority. Specify the boot device priority sequence from the available devices.

5.8 Save & Exit Menu

The Save & Exit menu allows users to load your system configuration with optimal or fail-safe default values.

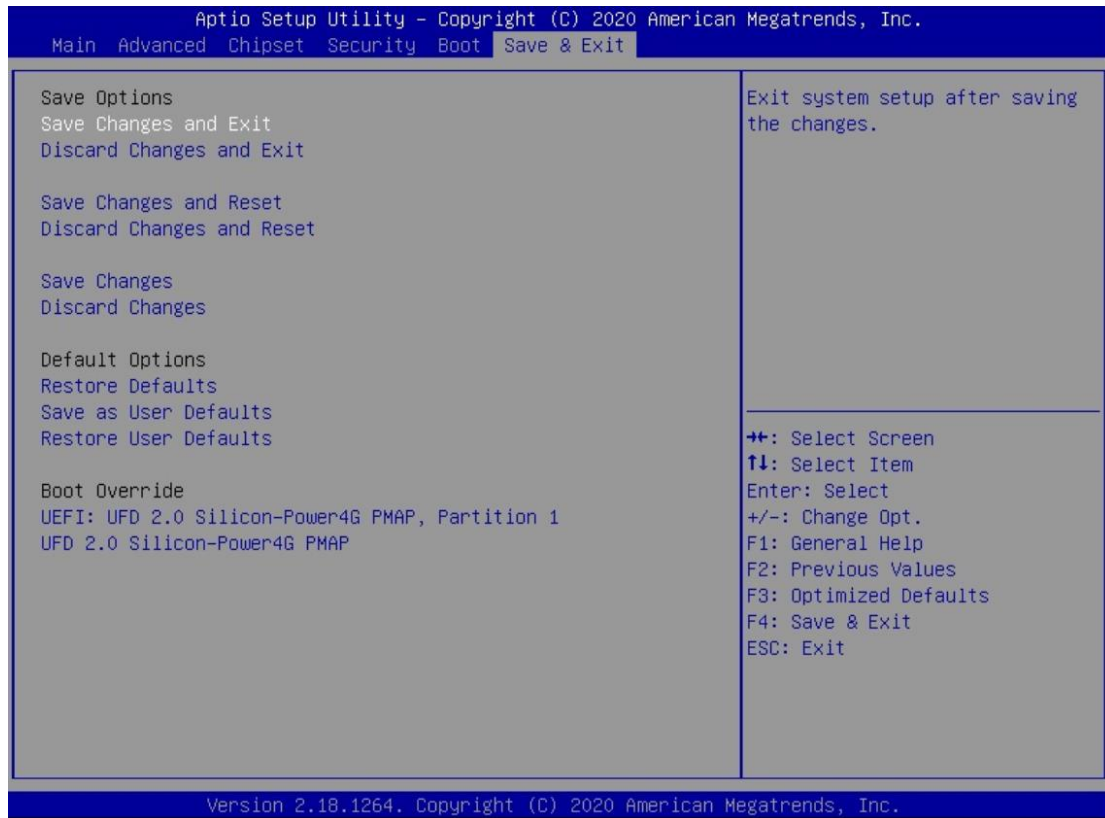

➤ Save Changes and Exit

When finishing the system configuration settings, select this option to leave Setup and return to Main Menu. Select Save Changes and Exit from the Save & Exit menu and press <Enter>. Select Yes to save changes and exit.

➤ Discard Changes and Exit

Select this option to quit Setup without making any permanent changes to the system configuration and return to Main Menu. Select Discard Changes and Exit from the Save & Exit menu and press <Enter>. Select Yes to discard changes and exit.

➤ Save Changes and Reset

When finishing the system configuration settings, select this option to leave Setup and reboot the computer so the new system configuration parameters can take effect. Select Save Changes and Reset from the Save & Exit menu and press <Enter>. Select Yes to save changes and reset.

- **Discard Changes and Reset**

Select this option to quit Setup without making any permanent changes to the system configuration and reboot the computer. Select Discard Changes and Reset from the Save & Exit menu and press <Enter>. Select Yes to discard changes and reset.
- **Save Changes**

When finishing the system configuration settings, select this option to save changes. Select Save Changes from the Save & Exit menu and press <Enter>. Select Yes to save changes.
- **Discard Changes**

Select this option to quit Setup without making any permanent changes to the system configuration. Select Discard Changes from the Save & Exit menu and press <Enter>. Select Yes to discard changes.
- **Restore Defaults**

After selecting this option, all the settings will be restored to defaults automatically. Select Restore Defaults from the Save & Exit menu and press <Enter>.
- **Save as User Defaults**

Select this option to save your current system configuration settings as User Defaults. Select Save as User Defaults from the Save & Exit menu and press <Enter>.
- **Restore User Defaults**

After selecting this option, all the settings will be restored to user defaults automatically. Select Restore User Defaults from the Save & Exit menu and press <Enter>.
- **Boot Override**

Select a drive to immediately boot that device regardless of the current boot order.

Appendix A

Watchdog Timer

A.1 About Watchdog Timer

After the system stops working for a while, it can be auto-reset by the watchdog timer. The integrated watchdog timer can be set up in the system reset mode by program.

A.2 How to Use Watchdog Timer

The following example enables configuration using a debug tool.

Enable WDT

↓

Enable configuration:

O 2E 87 ; Un-lock super I/O
O 2E 87

↓

Select logic device:

O 2E 07 ; Select logic register
O 2F 07 ; Switch to WDT device

↓

Set timer value:

O 2E F6 ; Select logic register
O 2F 05 ; Timer value 0~255 (Sec/Min) (Ex: 5)

↓

Clear WDT status (optional):

O 2E F5 ;
O 2F 40

↓

Set base timer:

O 2E F5
O 2F M ; M = 28h (Minute)
M = 20h (Second)

This page is intentionally left blank.