



***AXIOMTEK***

**tBOX324-894-FL-GND Series**

**Embedded System**

**User's Manual**



## **Disclaimers**

This manual has been carefully checked and believed to contain accurate information. Axiomtek Co., Ltd. assumes no responsibility for any infringements of patents or any third party's rights, and any liability arising from such use.

Axiomtek does not warrant or assume any legal liability or responsibility for the accuracy, completeness or usefulness of any information in this document. Axiomtek does not make any commitment to update the information in this manual.

Axiomtek reserves the right to change or revise this document and/or product at any time without notice.

No part of this document may be reproduced, stored in a retrieval system, or transmitted, in any form or by any means, electronic, mechanical, photocopying, recording, or otherwise, without the prior written permission of Axiomtek Co., Ltd.

©Copyright 2019 Axiomtek Co., Ltd.  
All Rights Reserved  
October 2019, Version A3  
Printed in Taiwan

## Safety Precautions

Before getting started, please read the following important safety precautions.

1. User should not modify any unmentioned jumper setting without Axiomtek FAE's instruction. Any modification without instruction might cause system to become damage
2. The tBOX324-894-FL-GND does not come equipped with an operating system. An operating system must be loaded first before installing any software into the computer.
3. Be sure to ground yourself to prevent static charge when installing the internal components. Use a grounding wrist strap and place all electronic components in any static-shielded devices. Most electronic components are sensitive to static electrical charge.
4. Disconnect the power cord from the tBOX324-894-FL-GND before making any installation. Be sure both the system and the external devices are turned OFF. Sudden surge of power could ruin sensitive components. Make sure the tBOX324-894-FL-GND is properly grounded.
5. Make sure the voltage of the power source is correct before connecting the equipment to the power outlet.
6. Turn OFF the system power before cleaning. Clean the system using a cloth only. Do not spray any liquid cleaner directly onto the screen.
7. Do not leave this equipment in an uncontrolled environment where the storage temperature is below  $-40^{\circ}\text{C}$  or above  $85^{\circ}\text{C}$ . It may damage the equipment.
8. Do not open the system's back cover. If opening the cover for maintenance is a must, only a trained technician is allowed to do so. Integrated circuits on computer boards are sensitive to static electricity. To avoid damaging chips from electrostatic discharge, observe the following precautions:
  - Before handling a board or integrated circuit, touch an unpainted portion of the system unit chassis for a few seconds. This will help to discharge any static electricity on your body.
  - When handling boards and components, wear a wrist-grounding strap, available from most electronic component stores.

## **Classification**

1. Degree of protection against electric shock: not classified
2. Degree of protection against the ingress of water: IP30
3. Equipment not suitable for use in the presence of a flammable anesthetic mixture with air or with oxygen or nitrous oxide.
4. Mode of operation: Continuous

## **General Cleaning Tips**

You may need the following precautions before you begin to clean the computer. When you clean any single part or component for the computer, please read and understand the details below fully.

When you need to clean the device, please rub it with a piece of dry cloth.

1. Be cautious of the tiny removable components when you use a vacuum cleaner to absorb the dirt on the floor.
2. Turn the system off before you start to clean up the component or computer.
3. Never drop the components inside the computer or get circuit board damp or wet.
4. Be cautious of all kinds of cleaning solvents or chemicals when you use it for the sake of cleaning. Some individuals may be allergic to the ingredients.
5. Try not to put any food, drink or cigarette around the computer.

## Cleaning Tools:

Although many companies have created products to help improve the process of cleaning your computer and peripherals users can also use household items to clean their computers and peripherals. Below is a listing of items you may need or want to use while cleaning your computer or computer peripherals.

Keep in mind that some components in your computer may only be able to be cleaned using a product designed for cleaning that component, if this is the case it will be mentioned in the cleaning.

- Cloth: A piece of cloth is the best tool to use when rubbing up a component. Although paper towels or tissues can be used on most hardware as well, we still recommend you to rub it with a piece of cloth.
- Water or rubbing alcohol: You may moisten a piece of cloth a bit with some water or rubbing alcohol and rub it on the computer. Unknown solvents may be harmful to the plastics parts.
- Vacuum cleaner: Absorb the dust, dirt, hair, cigarette particles, and other particles out of a computer can be one of the best methods of cleaning a computer. Over time these items can restrict the airflow in a computer and cause the circuitry to corrode.
- Cotton swabs: Cotton swabs moistened with rubbing alcohol or water are excellent tools for wiping hard to reach areas in your keyboard, mouse, and other locations.
- Foam swabs: Whenever possible it is better to use lint-free swabs such as foam swabs.



***NOTE: We strongly recommended that you should shut down the system before you start to clean any single components.***

Please follow the steps below:

1. Close all application programs
2. Close operating software
3. Turn off power switch
4. Remove all device
5. Pull out power cable

## **Scrap Computer Recycling**

If the computer equipment need the maintenance or are beyond repair, we strongly recommended that you should inform your Axiomtek distributor as soon as possible for the suitable solution. For the computers that are no longer useful or no longer working well, please contact your Axiomtek distributor for recycling and we will make the proper arrangement.

## **Trademarks Acknowledgments**

Axiomtek is a trademark of Axiomtek Co., Ltd.

Windows® is a trademark of Microsoft Corporation.

AMI® is a registered trademark of American Megatrends Inc.

IBM, PC/AT, PS/2, VGA are trademarks of International Business Machines Corporation.

Intel® and Atom™ are trademarks of Intel Corporation.

Winbond is a trademark of Winbond Electronics Corp.

Other brand names and trademarks are the properties and registered brands of their respective owners.

# Table of Contents

---

|  |           |
|--|-----------|
| Safety Precautions .....                       | iii       |
| Classification .....                           | iv        |
| <b>CHAPTER 1 INTRODUCTION .....</b>            | <b>1</b>  |
| 1.1    General Description .....               | 1         |
| 1.2    System Specifications .....             | 2         |
| 1.2.1    CPU .....                             | 2         |
| 1.2.2    System I/O .....                      | 2         |
| 1.2.3    System Specification.....             | 2         |
| 1.2.4    Driver CD Content.....                | 3         |
| 1.3    Dimensions .....                        | 4         |
| 1.4    I/O Outlets.....                        | 6         |
| 1.5    Packing List.....                       | 7         |
| <b>CHAPTER 2 HARDWARE INSTALLATION .....</b>   | <b>9</b>  |
| 2.1    Swappable HDD/SSD or CFast™ Card.....   | 9         |
| 2.2    Express Mini Card& DDR.....             | 10        |
| 2.3    Installing Grounding Screw.....         | 12        |
| <b>CHAPTER 3 CONNECTOR .....</b>               | <b>13</b> |
| 3.1    Connectors .....                        | 13        |
| 3.1.1    DVI / VGA / CANBUS Connector.....     | 13        |
| 3.1.2    Serial Port Connector .....           | 15        |
| 3.1.3    USB3.0 Stack Ports .....              | 15        |
| 3.1.4    LED Indicators.....                   | 16        |
| 3.1.5    DC Power Input connector.....         | 16        |
| 3.1.6    LAN Connector (LAN1~ LAN4) .....      | 18        |
| 3.1.7    Digital I/O Connector .....           | 19        |
| 3.1.8    SIM Card Connector .....              | 19        |
| 3.1.9    PCI-Express Mini Card Connector ..... | 20        |
| 3.1.10    CFast™ Socket .....                  | 21        |
| 3.1.11    Antenna opening .....                | 21        |
| 3.1.12    HDD tray locker.....                 | 22        |
| 3.1.13    Remote switch Connector .....        | 22        |
| <b>CHAPTER 4 AMI BIOS SETUP UTILITY .....</b>  | <b>23</b> |
| 4.1    Starting .....                          | 23        |
| 4.2    Navigation Keys .....                   | 24        |
| 4.3    Main Menu .....                         | 25        |
| 4.4    Advanced Menu .....                     | 26        |
| 4.5    Chipset Menu .....                      | 35        |
| 4.6    Security Menu .....                     | 38        |
| 4.7    Boot Menu .....                         | 39        |
| 4.8    Save & Exit Menu .....                  | 40        |
| <b>APPENDIX A WATCHDOG TIMER .....</b>         | <b>41</b> |
| <b>APPENDIX B DIGITAL I/O .....</b>            | <b>43</b> |

**This page is intentionally left blank.**



## CHAPTER 1 INTRODUCTION

This chapter contains general information and detailed specifications of the tBOX324-894-FL-GND. Chapter 1 includes the following sections:

- General Description
- System Specification
- Dimensions
- I/O Outlets
- Package List

### 1.1 General Description

The tBOX324-894-FL-GND is an embedded system that supports 7<sup>th</sup> Gen. Intel® Celeron - 3965U / Core™ i3-7100U / i5-7300U / i7-7600U processor (2.2 up to 2.8 GHz) onboard, to provide Windows® 10 and Linux, optimized for the most endurable operation. It features fanless design with rich I/O, supports SO-DIMM up to 32GB, and enhanced system dependability by built-in Watchdog Timer.

#### ● Features

- 7<sup>th</sup> Generation Intel® Core™ I (15W) processor onboard
- Support SO-DIMM DDR4-2133 up to 32GB
- CE ,DNV2.4, EN50155 ,E-Mark, ISO7637-2 certificate
- Fanless with operating temperature range of -40°C ~ +70°C with W.T. SSD (0°C ~ +55°C with HDD)
- Isolated RS-232/422/485 and DIO
- Supports USB 3.0 and SATA3
- 2x removable & lockable 2.5" SATA drive bays and 1x CFast™
- 3x internal mini PCIe slots and 1x SIM socket
- Lockable I/O ports, LAN connectors
- Comply to fire protection of vehicles Europe standard PrCEN TS 45545-2

#### ● Reliable and Stable Design

- The tBOX324-894-FL-GND adopts the advanced cooling system and supporting CFast™, which makes it especially suitable for vibration environments, the best for industrial automation, digital signage, and gaming application.

#### ● Embedded O/S Supported

- The tBOX324-894-FL-GND is not only supported Windows® 10, but also embedded O/S, such as Windows® 10 Embedded, and Linux. For storage device, the tBOX324-894-FL-GND is supported 2x 2.5" SATA drive bays and 1x CFast™ slot.

## 1.2 System Specifications

### 1.2.1 CPU

- **CPU**
  - Onboard Intel® Core™ Celeron -3965U / Core™ i3-7100U / i5-7300U / i7-7600U processor (2.2 up to 2.8 GHz) processor (2M / 3M Cache 2.2GHz up to 2.8 GHz)
- **BIOS**
  - American Megatrends Inc. BIOS.
  - “Load Optimized Default” to backup customized Setting in the BIOS flash chip to prevent from CMOS battery fail
- **System Memory**
  - DDR4 SO-DIMM socket up to DDR4-2133 Memory
- **Graphics**
  - Integrated Intel® HD Graphics 620 for DVI / VGA

### 1.2.2 System I/O

- 2x 10-pin Terminal Block connectors, COM3/4 for isolated RS-232/422/485
- 1x DVI-I / VGA female connector
- 2x screw audio connectors (Mic-IN/Line-OUT)
- 4x isolated Gbe LAN (M12 or RJ45) connectors for 10/100/1000Base-T
- 4x USB 3.0 connectors (front side)
- 1x 12-pin isolated 4-in/4-out DIO connector
- 1x 24VDC power input connector (M12-5P or Terminal Block-3P)
- 2x DB9 type COM1/2 for isolated RS232/422/485, COM2 (option CAN BUS)

### 1.2.3 System Specification

- **Watchdog Timer**
  - Reset supported; 255 levels, 0~255 sec.
- **Power Supply**
  - 12/24 VDC-in power supply, Power Rate:2.2A@24VDC (vehicle application)
  - 24 VDC-in power supply, Power Rate: 2.2A@24VDC (marine application)
  - 110VDC-in power supply, Power Rate: 0.48A@110VDC (railway application)
- **Operation Temperature**
  - -40°C ~ +70°C (- 40°F ~ 158°F) with W.T. SSD
  - 0°C ~ +55°C (+32°F ~ +131°F) with HDD
- **Storage Temperature**
  - -40°C ~ 85°C (- 40°F ~ 176°F)
- **Humidity**
  - 10% ~ 95% (non-condensation)
- **Vibration Endurance**
  - 3Grms w/ SSD (5 ~ 500Hz, X, Y, Z direction; random)
  - 1Grms w/ HDD (5 ~ 500Hz, X, Y, Z direction; random)

- **Weight**
  - 5 kg (11lb) without package
  - 6.5kg (14.33lb) with package
- **Dimensions**
  - 288.5mm(11.36")(W) x 211.3mm(8.32")(D) x 85.75mm(3.38")(H)



**NOTE: All specifications and images are subject to change without notice.**

#### 1.2.4 Driver CD Content

- **Chipset Driver**
- **Graphic Driver**
- **Audio Driver**
- **Ethernet Driver**
- **ME Driver**
- **RST Driver**
- **Utilites**

### 1.3 Dimensions

The following diagrams show you dimensions and outlines of the tBOX324-894-FL-GND.

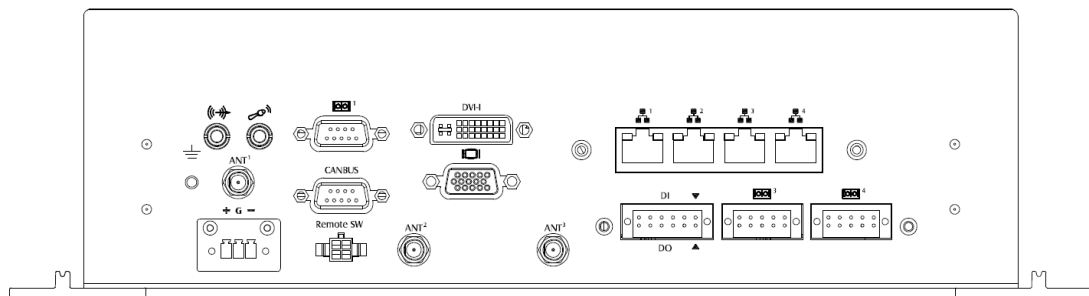
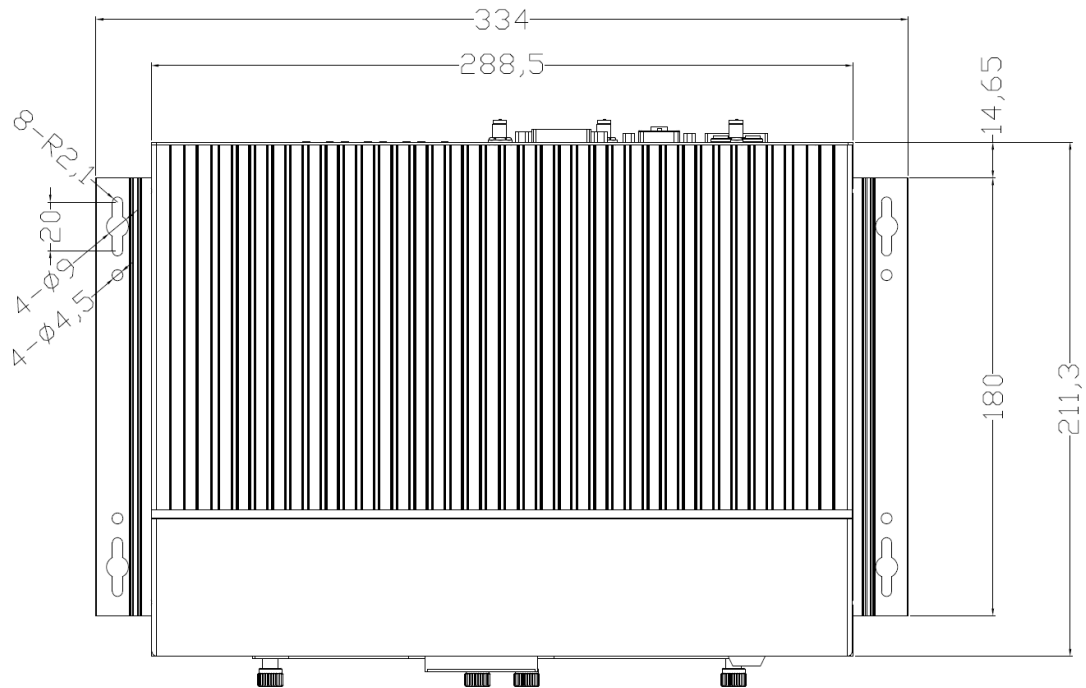

▲ 24VDC-in marine application

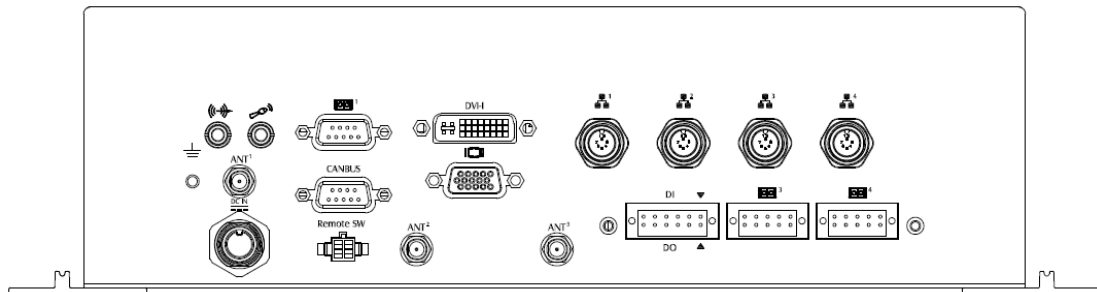

▲ 110VDC-in railway application

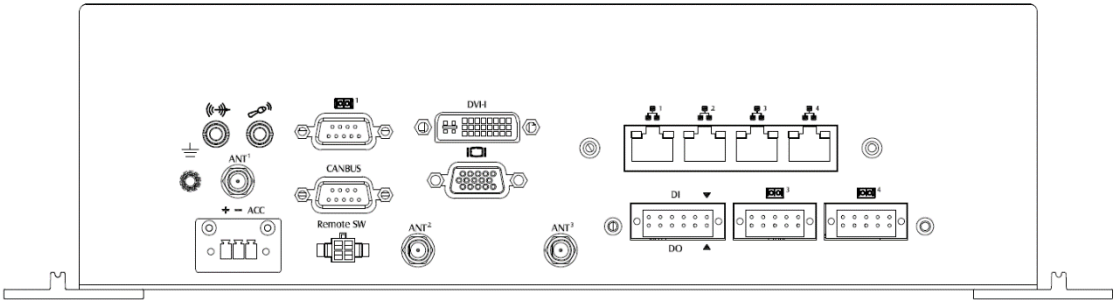

▲ 12/24VDC-in vehicle application



## 1.4 I/O Outlets

The following figures show you I/O outlets on front view of the tBOX324-894-FL-GND.

- **Front View**



- **Front View Drawing**

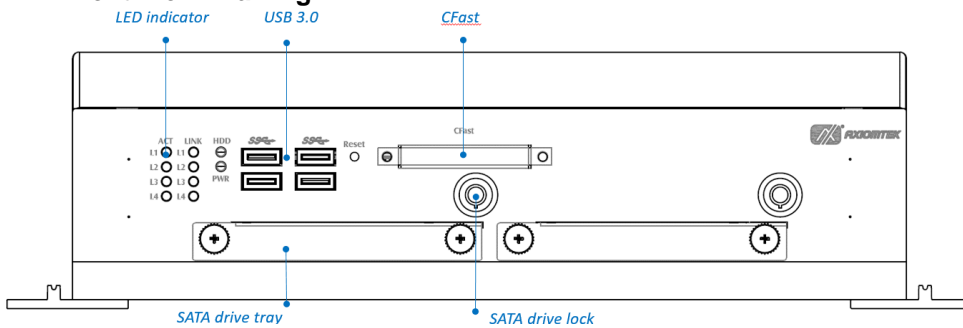

- **Rear View**

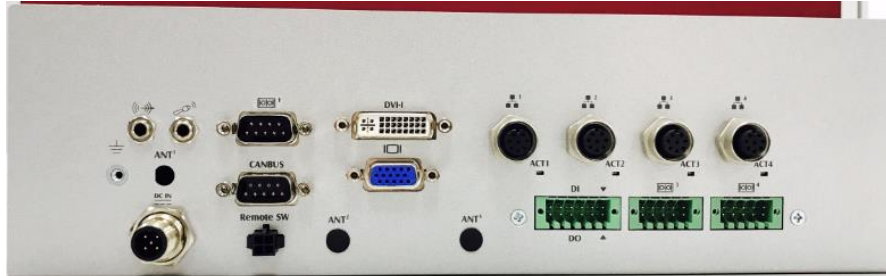

- **Rear View Drawing**

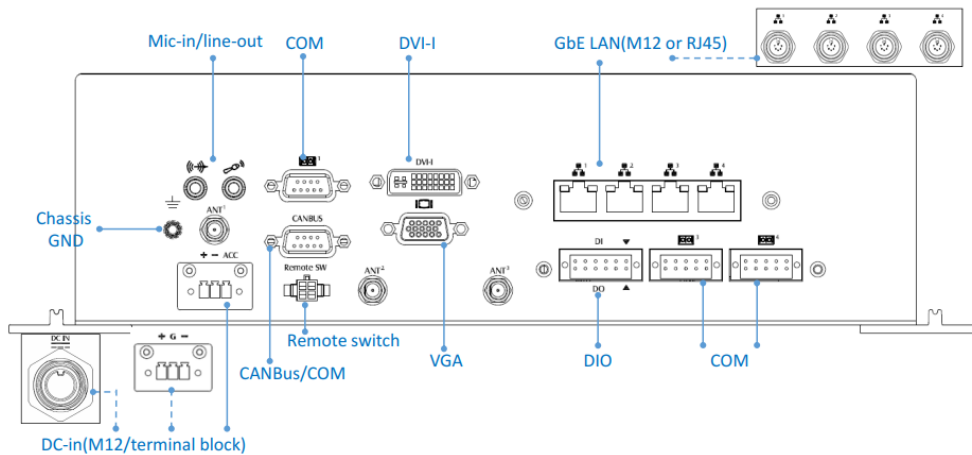

## 1.5 Packing List

The package bundled with your tBOX324-894-FL-GND should contain the following items:

- tBOX324-894-FL-GND System Unit x 1
- tBOX324-894-FL-GND Quick Installation Guide x 1
- CD x 1 (with Driver)
- Screws Pack x 1
- Foot Pad x 4
- Wallmount Bracket x 1
- SATA Drive Key x 2
- DRAM Thermal Pad x 4
- DC-IN Connector (power terminal block)
- SATA Drive (HDD or SSD) (optional)
- Remote Switch cable x1(optional)
- CFast (optional)
- Express Mini Card Module (optional)
- 3G/4G/GPS module x 1 (optional)
- Wi-Fi/Bluetooth module x 1 (optional)
- M12 power cable x 1 (optional)

If you can't find this package or any items are missing, please contact Axiomtek distributors immediately.

**This page is intentionally left blank.**



## CHAPTER 2 HARDWARE INSTALLATION

The tBOX324-894-FL-GND is convenient for your various hardware configurations, such as HDD (Hard Disk Drive), CFast™ card and mini PCIe card. The chapter 2 will show you how to install the hardware.

### 2.1 Swappable HDD/SSD or CFast™ Card

**Step 1** Make sure system power is off, and then loosen the screw at HDD tray as shown.



**Step 2** Slide HDD into the cover as picture shown. Insert screws into each side of the SATA drive through the corresponding holes.



**Step 3** Install CFast and SATA drive to the slot.



**Step 4** Secure CFast and SATA drive to complete the installation.

## 2.2 Express Mini Card& DDR

Step 1 Make sure system power is off and unplug the power cord.

Step 2 Turn the system upside down and loosen the lateral cover screws as shown to remove the bottom cover.

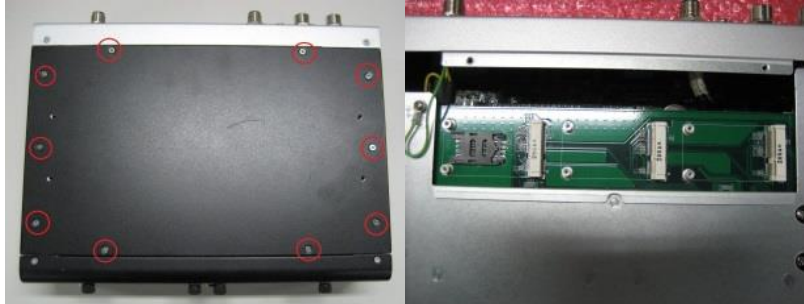

One slot contains an internal SIM card slot which can support 2G/3G/4G modules.

### For the Express Mini card:

Step 3 Slide SIM or Mini card into slot cautiously.



Step 4 Fasten the screws to complete the installation.



### For the DDR:

Step 5 Loosen the side screws as shown.



**Step 6 Pull out the front bezel and internal bracket as shown.**

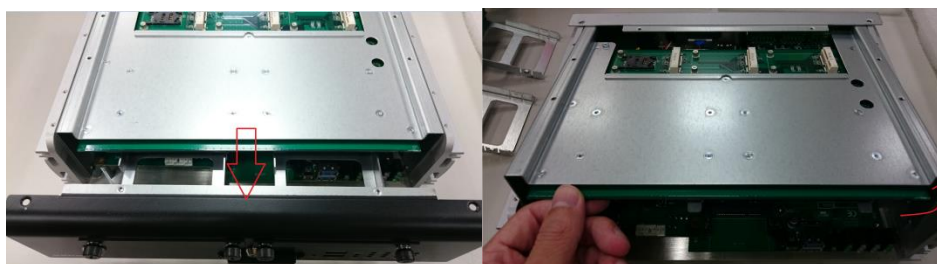

**Step 7 Loosen below screws to remove cover and put on the thermal pad.**



**Step 8 Install the DDR cautiously and put on the thermal again.**

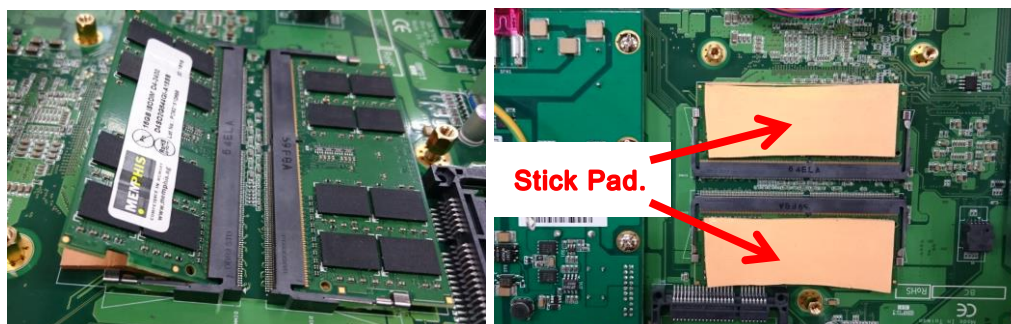

**Step 9 Secure DRAM cover and install the internal bracket, front bezel. Fasten the all screws to complete the installation.**

## 2.3 Installing Grounding Screw

◆ Fasten Grounding Screw for Installation order → follow step 1 to step 6 :

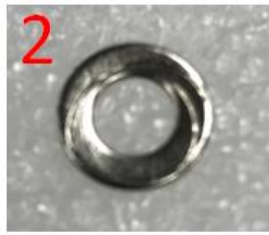

## CHAPTER 3 CONNECTOR

### 3.1 Connectors

Connectors are connected the CPU board with other parts of the system. Loose or improper connection might cause problems. Make sure all connectors are properly and firmly connected before your turn on the system.

#### 3.1.1 DVI / VGA / CANBUS Connector

##### DVI-I

| Pin | Signal       | Pin | Signal          |
|-----|--------------|-----|-----------------|
| 1   | TMDS Data 2- | 2   | TMDS Data 2+    |
| 3   | GND          | 4   | CRT_SPD_Clock   |
| 5   | CRT_SPD_Data | 6   | DVI_SPD_Clock   |
| 7   | DVI_SPD_Data | 8   | Analog Vsync    |
| 9   | TMDS Data 1- | 10  | TMDS Data 1+    |
| 11  | GND          | 12  | N.C             |
| 13  | N.C.         | 14  | +5V             |
| 15  | GND          | 16  | Hot Plug Detect |
| 17  | TMDS Data 0- | 18  | TMDS Data 0+    |
| 19  | GND          | 20  | N.C             |
| 21  | N.C          | 22  | GND             |
| 23  | TMDS Clock+  | 24  | TMDS Clock-     |
| C1  | Analog RED   | C2  | Analog Green    |
| C3  | Analog Blue  | C4  | Analog Hsync    |
| C5  | GND          |     |                 |

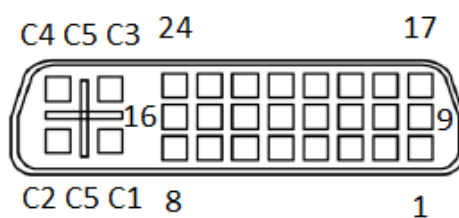

### VGA

| Pin | Signal          | Pin | Signal        | Pin | Signal   |
|-----|-----------------|-----|---------------|-----|----------|
| 1   | Red             | 2   | Green         | 3   | Blue     |
| 4   | N.C.            | 5   | GND           | 6   | GND      |
| 7   | GND             | 8   | GND           | 9   | VCC      |
| 10  | GND             | 11  | N.C.          | 12  | DDC DATA |
| 13  | Horizontal Sync | 14  | Vertical Sync | 15  | DDC CLK  |



### CANBUS (optional)

| Pin | Signal                            |
|-----|-----------------------------------|
| 1   | N.C.                              |
| 2   | CAN_L, Low-Level CAN Voltage I/O  |
| 3   | GND, CAN side GND                 |
| 4   | N.C.                              |
| 5   | N.C.                              |
| 6   | GND, CAN side GND                 |
| 7   | CAN_H, High-Level CAN Voltage I/O |
| 8   | N.C.                              |
| 9   | N.C.                              |

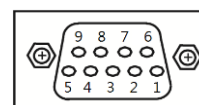

The CAN connector function will not block data transmission on vehicle data bus-systems, which are used to transmit data, required to ensure the correct functioning of other immunity related functions.

The vehicle is not possible to be stopped or interrupted from the ESA or from the service center.



### 3.1.2 Serial Port Connector

The COM3~COM4 port connector is a 2x5 terminal block connector. The pin assignment of RS-232/RS-422/RS-485 is listed on the following table. If you need COM port to support RS-422 or RS-485, please set it up in BIOS settings.

| Pin | RS-232                   | RS-422      | RS-485      |
|-----|--------------------------|-------------|-------------|
| 1   | DCD, Data carrier detect | TX-         | Data-       |
| 2   | RXD, Receive data        | TX+         | Data+       |
| 3   | TXD, Transmit data       | RX+         | NC          |
| 4   | DTR, Data terminal ready | RX-         | NC          |
| 5   | GND, ground              | GND, ground | GND, ground |
| 6   | DSR, Data set ready      | NC          | NC          |
| 7   | RTS, Request to send     | NC          | NC          |
| 8   | CTS, Clear to send       | NC          | NC          |
| 9   | RI, Ring indicator       | NC          | NC          |
| 10  | NC                       | NC          | NC          |

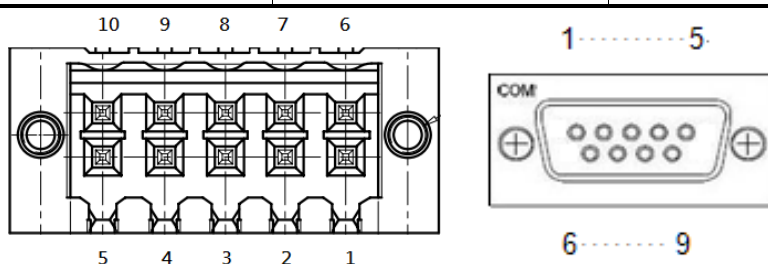

### 3.1.3 USB3.0 Stack Ports

| Pin | Signal USB Port 0                 | Pin | Signal USB Port 1                 |
|-----|-----------------------------------|-----|-----------------------------------|
| 1   | USB_VCC (+5V level standby power) | 10  | USB_VCC (+5V level standby power) |
| 2   | USB_Data2-                        | 11  | USB_Data3-                        |
| 3   | USB_Data2+                        | 12  | USB_Data3+                        |
| 4   | GND                               | 13  | GND                               |
| 5   | SSRX2-                            | 14  | SSRX3-                            |
| 6   | SSRX2+                            | 15  | SSRX3+                            |
| 7   | GND                               | 16  | GND                               |
| 8   | SSTX2-                            | 17  | SSTX3-                            |
| 9   | SSTX2+                            | 18  | SSTX3+                            |

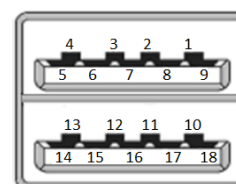

### 3.1.4 LED Indicators

| Status\LED | ACT( L1~L4)    | LINK(L1~L4) | HDD           | POWER          |
|------------|----------------|-------------|---------------|----------------|
| LAN Linked | Bright (Green) |             |               |                |
| 100Mbps    |                | Green LED   |               |                |
| 1000Mbps   |                | Orange LED  |               |                |
| HDD Active |                |             | Flash(Orange) |                |
| Power on   |                |             |               | Bright (Green) |



| M12 LAN | Status\LED |
|---------|------------|
| Dark    | Link off   |
| Bright  | Link on    |
| Flash   | Active     |

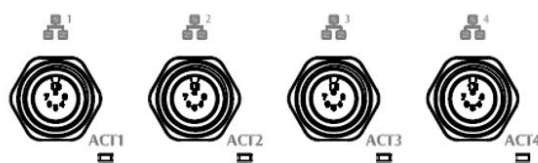

### 3.1.5 DC Power Input connector

There are three pins of the DC-in connector as below table

#### DC Power input (optional)

| Pin | Marine/ Railway | Vehicle |
|-----|-----------------|---------|
| 1   | +               | +       |
| 2   | G               | -       |
| 3   | -               | ACC     |

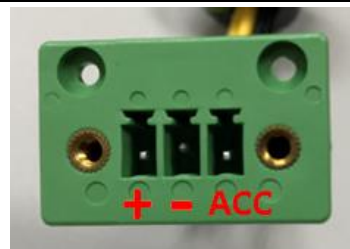
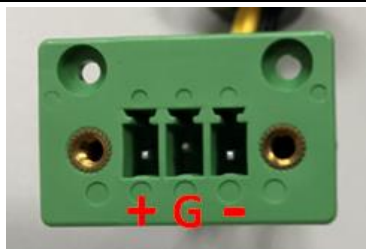



The DC power input connector is M12 A-code Male 5Pin connector

| Pin | Signal      |
|-----|-------------|
| 1   | VCC         |
| 2   | VCC         |
| 3   | System GND  |
| 4   | System GND  |
| 5   | Chassis GND |

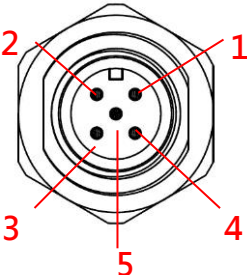

### 3.1.6 LAN Connector (LAN1~ LAN4)

The RJ-45 LAN connectors which support 10/100/1000Mbps

#### Ethernet (optional)

| Pin | Description                     | 10/100Base-T                                     | 1000Base-T |
|-----|---------------------------------|--|------------|
| 1   | Transmit Data+ or Bidirectional | TX+  | BI_DA+     |
| 2   | Transmit Data- or Bidirectional | TX-  | BI_DA-     |
| 3   | Receive Dtata+ or Bidirectional | RX+  | BI_DB+     |
| 4   | Not Connected or Bidirectional  | N.C.   | BI_DC+     |
| 5   | Not Connected or Bidirectional  | N.C.   | BI_DC-     |
| 6   | Receive Dtata- or Bidirectional | RX-  | BI_DB-     |
| 7   | Not Connected or Bidirectional  | N.C.   | BI_DD+     |
| 8   | Not Connected or Bidirectional  | N.C.   | BI_DD-     |
| B   | Speed LED                       | OFF/Green  | Orange     |
| A   | Activity Link LED(Orange)       | OFF: No Link<br>Blinking: Data activity detected |            |

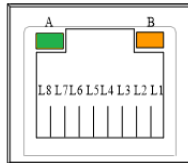

#### Ethernet (optional)

| Pin | 10/100 Mbps | 1000 Mbps |
|-----|-------------|-----------|
| 1   | --          | MDI 2+    |
| 2   | --          | MDI 3+    |
| 3   | --          | MDI 3-    |
| 4   | TX -        | MDI 0-    |
| 5   | RX +        | MDI 1+    |
| 6   | TX +        | MDI 0+    |
| 7   | --          | MDI 2 -   |
| 8   | RX -        | MDI 1 -   |

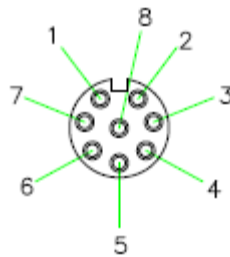

M12-A Code 8Pin/ Female

### 3.1.7 Digital I/O Connector

The tBOX324-894-FL-GND is supported an isolated 4-in/4-out Digital I/O (DIO)

| Pin | Signal | Pin | Signal    |
|-----|--------|-----|-----------|
| 1   | COM+   | 7   | Ext Power |
| 2   | OUT0   | 8   | IN 0      |
| 3   | OUT1   | 9   | IN 1      |
| 4   | OUT2   | 10  | IN 2      |
| 5   | OUT3   | 11  | IN 3      |
| 6   | COM-   | 12  | GND       |

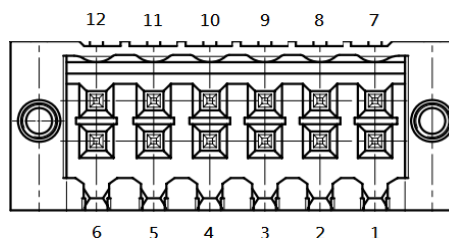

**NOTE:** Please refer to Appendix B for more information about Digital I/O

### 3.1.8 SIM Card Connector

The SIM Card slot is an ISO 7816 standard 6-pin connector for PCI Express Mini Card.

| Pin | Signal    |
|-----|-----------|
| C1  | SIM_PWR   |
| C2  | SIM_RESET |
| C3  | SIM_CLK   |
| C5  | GND       |
| C6  | SIM_VPP   |
| C7  | SIM_DATA  |

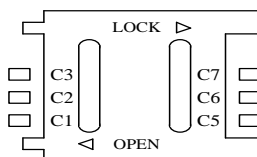

### 3.1.9 PCI-Express Mini Card Connector

The PCI Express Mini Card connectors are supported 1x PCI Express lane and 2x USB 2.0 lanes. A PCI Express Mini Card can be applied either PCI Express or USB 2.0. It's very helpful that we designed USB 2.0 and PCI Express lane in the same slot once it was been an interface migration. We provide a convient and low cost solution for you by this friendly design.

| Pin | Signal  | Pin | Signal    |
|-----|---------|-----|-----------|
| 1   | WAKE#   | 2   | +3.3VSB   |
| 3   | No use  | 4   | GND       |
| 5   | No use  | 6   | +1.5V     |
| 7   | CLKREQ# | 8   | No use    |
| 9   | GND     | 10  | No use    |
| 11  | REFCLK- | 12  | No use    |
| 13  | REFCLK+ | 14  | No use    |
| 15  | GND     | 16  | No use    |
| 17  | No use  | 18  | GND       |
| 19  | No use  | 20  | +3.3VSB   |
| 21  | GND     | 22  | PERST#    |
| 23  | PE_RXN4 | 24  | +3.3VSB   |
| 25  | PE_RXP4 | 26  | GND       |
| 27  | GND     | 28  | +1.5V     |
| 29  | GND     | 30  | SMB_CLK   |
| 31  | PE_TXN4 | 32  | SMB_DATA  |
| 33  | PE_TXP4 | 34  | GND       |
| 35  | GND     | 36  | USB_D3-   |
| 37  | GND     | 38  | USB_D3+   |
| 39  | +3.3VSB | 40  | GND       |
| 41  | +3.3VSB | 42  | LED_WWAN# |
| 43  | GND     | 44  | LED_WLAN# |
| 45  | No use  | 46  | LED_WPAN# |
| 47  | No use  | 48  | +1.5V     |
| 49  | No use  | 50  | GND       |
| 51  | No use  | 52  | +3.3VSB   |

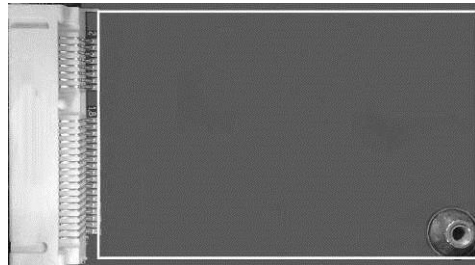
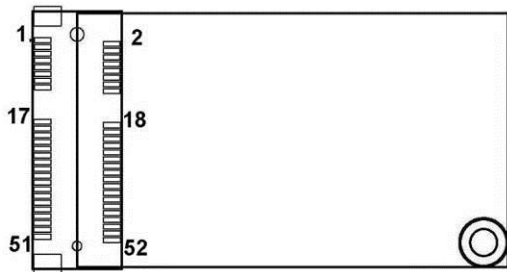

### 3.1.10 CFast™ Socket

The tBOX324-894-FL-GND is equipped with a CFast™ slot via SATA lane, and supported DMA mode. The socket is especially designed to avoid incorrect installation of the CFast™ card. Please make sure the system power is off while you are installing/ uninstalling CFast™ card.

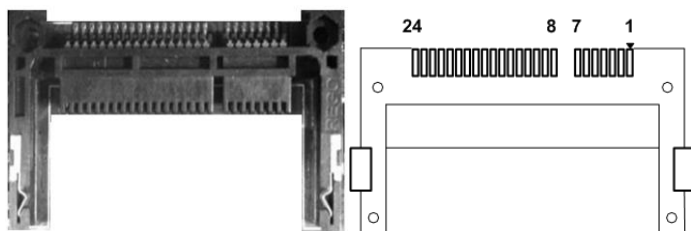

| Pin | Description | Pin | Description |
|-----|-------------|-----|-------------|
| 1   | GND         | 13  | N.C         |
| 2   | SATA_TX+    | 14  | GND         |
| 3   | SATA_TX-    | 15  | N.C         |
| 4   | GND         | 16  | CFAST_LED#  |
| 5   | SATA_RX-    | 17  | N.C         |
| 6   | SATA_RX+    | 18  | N.C         |
| 7   | GND         | 19  | N.C         |
| 8   | N.C         | 20  | +3.3V Level |
| 9   | GND         | 21  | +3.3V Level |
| 10  | N.C         | 22  | GND         |
| 11  | N.C         | 23  | GND         |
| 12  | N.C         | 24  | N.C         |

### 3.1.11 Antenna opening



Profile opening is reserved for Wi-Fi/3G/4G antennas.



ANT1

### 3.1.12 HDD tray locker

Lock and secure the swappable HDD/SSD bay.

| Stauts   | Diagram   |
|----------|---|
| Unlocked |  |
| Locked   |  |

### 3.1.13 Remote switch Connector

Remote switch is ideal for a remote botton which can act as an ATX power on/off botton.

| Pin | Signal         | Description  |
|-----|----------------|--|
| 1   | NC             |  |
| 2   | Switch Signal  | Low Active. Act as PC's ATX switch when external switch installed (Pin 3 Active)<br><b>**Internal pull up resister did not connect to any power source</b> |
| 3   | Ext. SW Sensor | Low Active. To detect external power swtich install or not.<br><b>** Internal pull up resister did not connect to any power source</b>                     |
| 4   | GND            |  |



## CHAPTER 4 AMI BIOS SETUP UTILITY

This chapter provides users with detailed description about how to set up basic system configuration through the AMI BIOS setup utility.

### 4.1 Starting

To enter the setup screens, follow the steps as below:

1. Turn on the computer and press the <Del> key immediately.
2. After pressing the <Delete> key, the main BIOS setup menu displays. You can access to other setup screens from the main BIOS setup menu, such as the Chipset and Power menus.



## 4.2 Navigation Keys

The BIOS setup/utility uses a key-based navigation system called hot keys. Most of the BIOS setup utility hot keys can be used at any time during the setup navigation process. These keys include <F1>, <F10>, <Enter>, <ESC>, <Arrow> keys, and so on.



**NOTE:** Some of navigation keys differ from one screen to another.

| Hot Keys             | Description  |
|----------------------|--|
| <b>← Left/Right</b>  | The Left and Right <Arrow> keys allow you to select a setup screen.  |
| <b>↑↓ Up/Down</b>    | The Up and Down <Arrow> keys allow you to select a setup screen or sub-screen.   |
| <b>+– Plus/Minus</b> | The Plus and Minus <Arrow> keys allow you to change the field value of a particular setup item.  |
| <b>Tab</b>           | The <Tab> key allows you to select setup fields.   |
| <b>F1</b>            | The <F1> key allows you to display the General Help screen.  |
| <b>F10</b>           | The <F10> key allows you to save any changes you have made and exit Setup. Press the <F10> key to save your changes.   |
| <b>Esc</b>           | The <Esc> key allows you to discard any changes you have made and exit the Setup. Press the <Esc> key to exit the setup without saving your changes.                       |
| <b>Enter</b>         | The <Enter> key allows you to display or change the setup option listed for a particular setup item. The <Enter> key can also allow you to display the setup sub- screens. |



### 4.3 Main Menu



#### System Time/Date

Use this option to change the system time and date. Highlight System Time or System Date using the <Arrow> keys. Enter new values through the keyboard. Press the <Tab> key or the <Arrow> keys to move between fields. The date must be entered in MM/DD/YY format. The time is entered in HH:MM:SS format.

## 4.4 Advanced Menu

The Advanced menu allows users to set configuration of the CPU and other system devices. You can select any of the items in the left frame of the screen to go to the sub menus:

- ▶ NCT6106D Super IO Configuration
- ▶ NCT6106D H/W Monitor
- ▶ Device Configuration
- ▶ CPU Configuration
- ▶ SATA And RST Configuration
- ▶ PCH-FW Configuration
- ▶ USB Configuration
- ▶ Utility Configuration

For items marked with “▶”, please press <Enter> for more options.

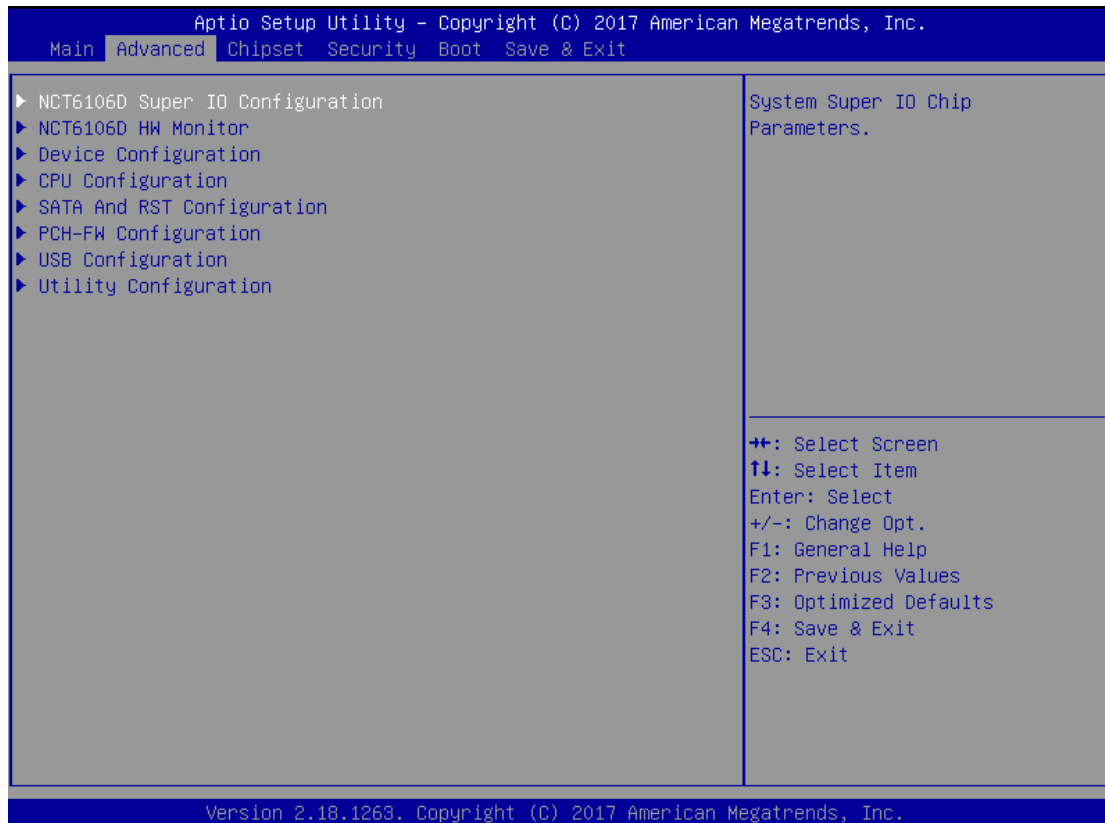

## NCT6106D Super IO Configuration

Set up options for the Super IO Configuration, and change the value of the selected option

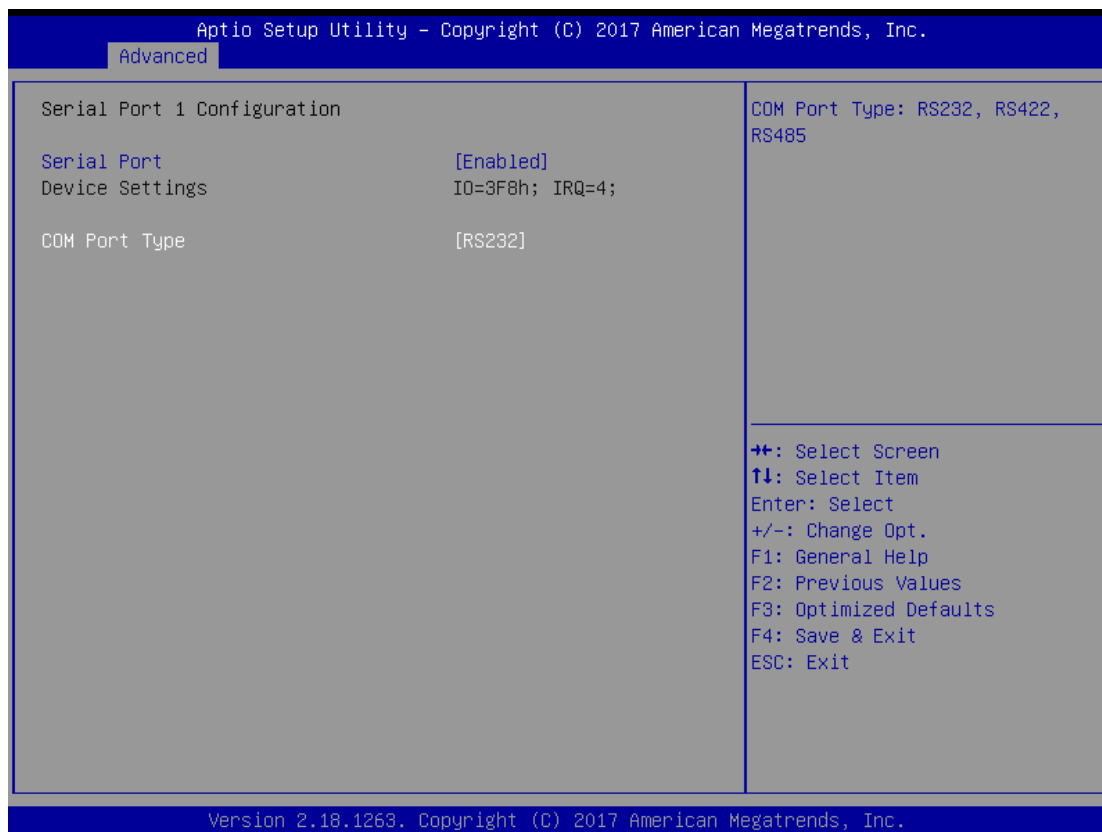

Serial Port 0-3 configuration

### Serial port

This option used to select RS-232/422/485 function.

### NCT6106D H/W Monitor

This screen shows the Hardware Health Configuration.

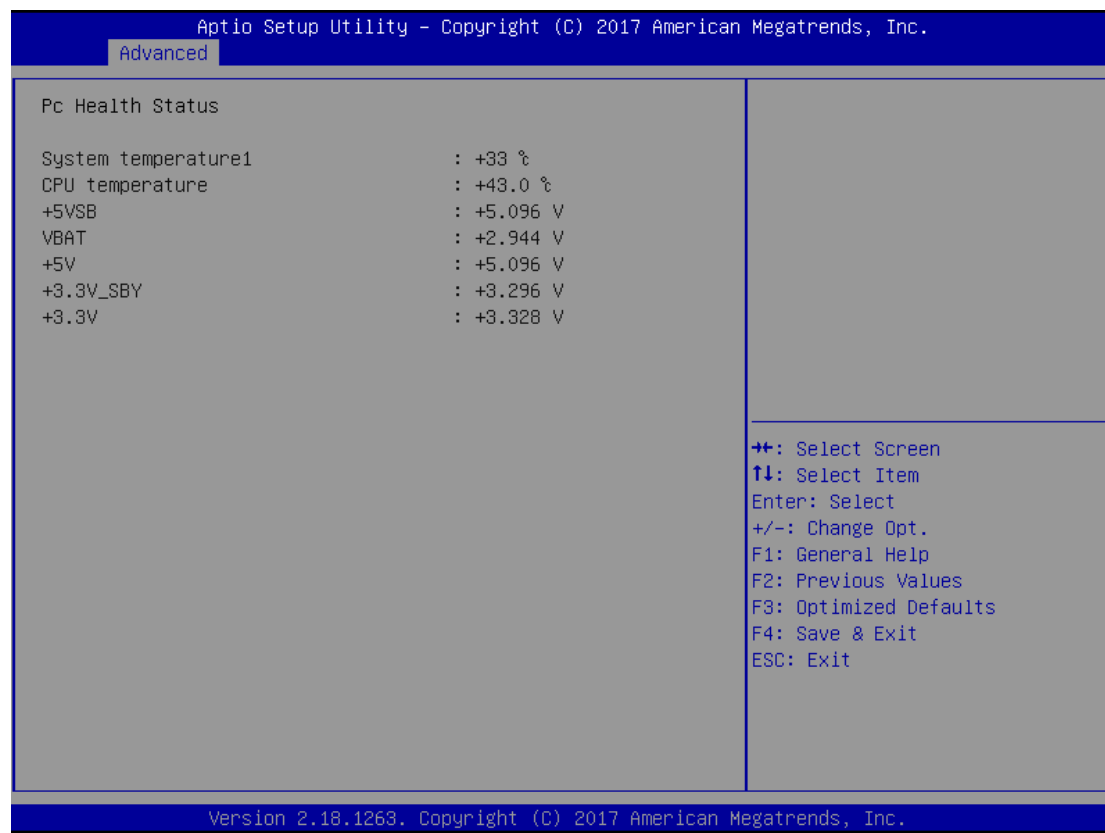

Aptio Setup Utility - Copyright (C) 2017 American Megatrends, Inc.

Advanced

Pc Health Status

|                     |   |          |
|---------------------|---|----------|
| System temperature1 | : | +33 %    |
| CPU temperature     | : | +43.0 %  |
| +5VSB               | : | +5.096 V |
| VBAT                | : | +2.944 V |
| +5V                 | : | +5.096 V |
| +3.3V_SBY           | : | +3.296 V |
| +3.3V               | : | +3.328 V |

++: Select Screen  
↑↓: Select Item  
Enter: Select  
+/-: Change Opt.  
F1: General Help  
F2: Previous Values  
F3: Optimized Defaults  
F4: Save & Exit  
ESC: Exit

Version 2.18.1263. Copyright (C) 2017 American Megatrends, Inc.

## Device Configuration

### Onboard DIO configuration status

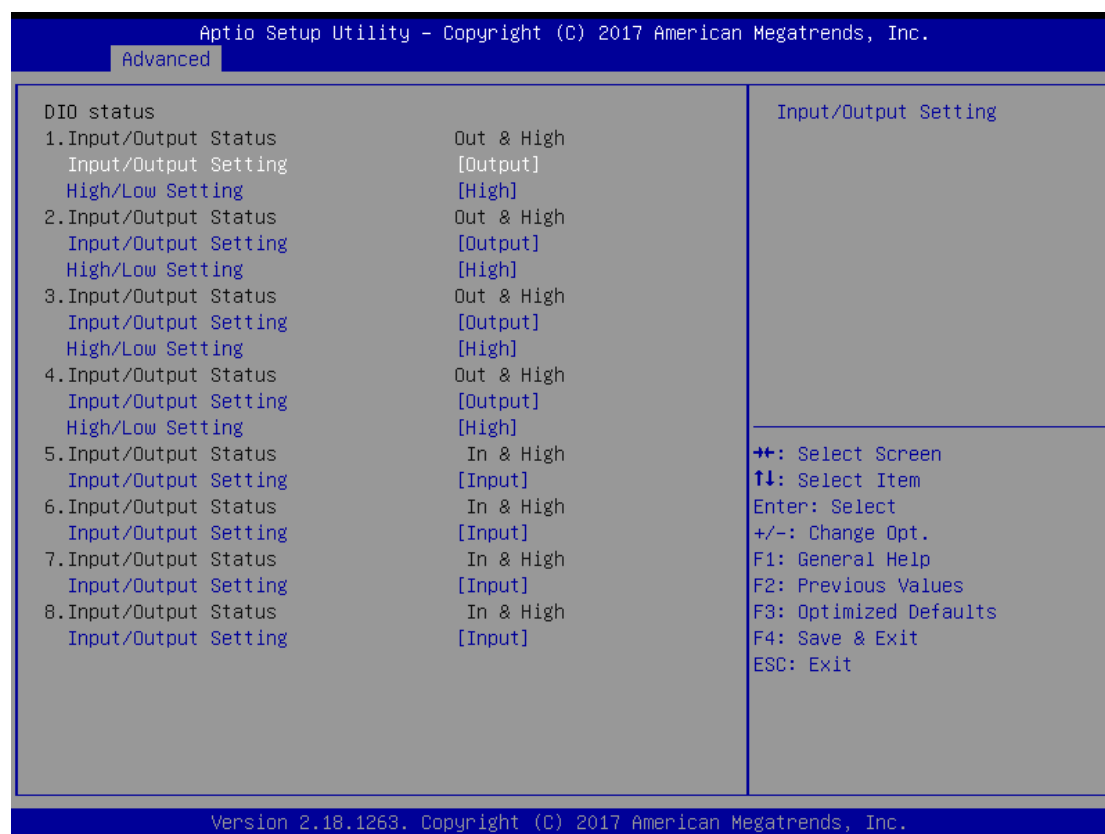

## CPU Configuration

This screen shows the CPU Configuration.

Aptio Setup Utility - Copyright (C) 2017 American Megatrends, Inc.

Advanced

|                                       |   |   |
|---------------------------------------|---|---|
| CPU Configuration                     |   | When enabled, a VMM can utilize the additional hardware capabilities provided by Vanderpool Technology. |
| Type                                  | Intel(R) Celeron(R) CPU 3965U @ 2.20GHz |   |
| ID                                    | 0x806E9                                 |   |
| Speed                                 | 2200 MHz                                |   |
| L1 Data Cache                         | 32 KB x 2                               |   |
| L1 Instruction Cache                  | 32 KB x 2                               |   |
| L2 Cache                              | 256 KB x 2                              |   |
| L3 Cache                              | 2 MB                                    |   |
| L4 Cache                              | N/A                                     |   |
| VMX                                   | Supported                               |   |
| SMX/TXT                               | Not Supported                           |   |
| Intel (VMX) Virtualization Technology | [Enabled]                               |   |

++: Select Screen  
↑↓: Select Item  
Enter: Select  
+/-: Change Opt.  
F1: General Help  
F2: Previous Values  
F3: Optimized Defaults  
F4: Save & Exit  
ESC: Exit

Version 2.18.1263. Copyright (C) 2017 American Megatrends, Inc.

**SATA Configuration**

Set SATA configuration.

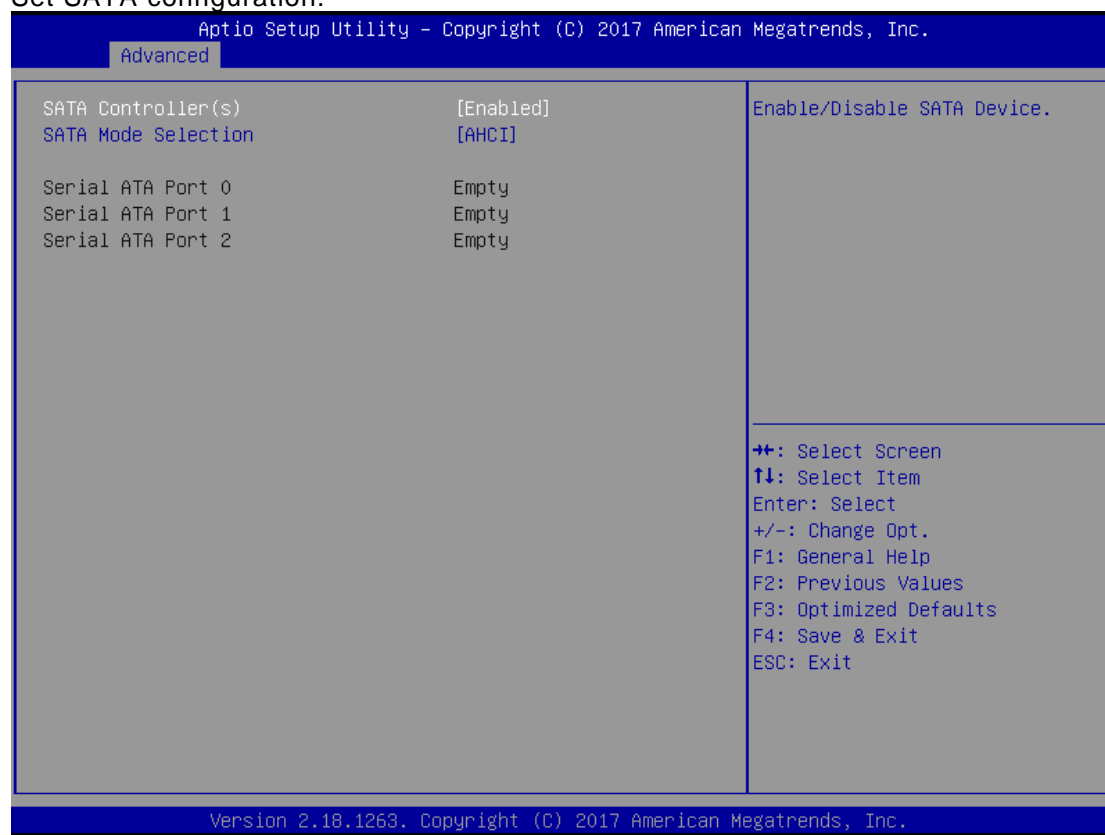
**SATA Controller(S)**

Enable or disable the integrated SATA controllers. (Default: Enabled)

**SATA Mode**

Choose the SATA operation mode. Here are the options for your selection.

**Serial-ATA Port 0-2**

Control the onboard SATA port. Here are the options for your selection, enabled and disabled.

## PCH-FW Configuration

Configure Intel(R) Active Management Technology Parameters.

Display ME firmware version and ME firmware SKU.

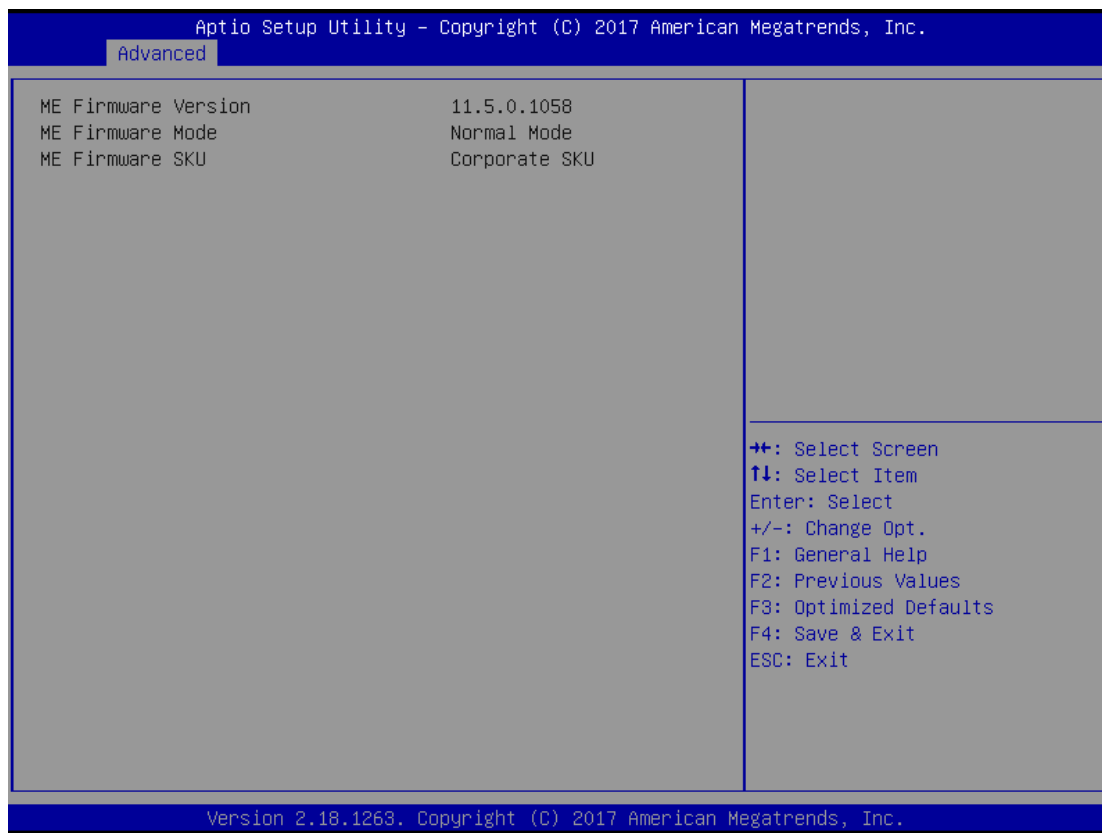



## USB Configuration

This screen shows the USB Device.

This is for supporting USB device on legacy OS, the system will automatically detect any USB device is connected with the computer and enable USB legacy mode.

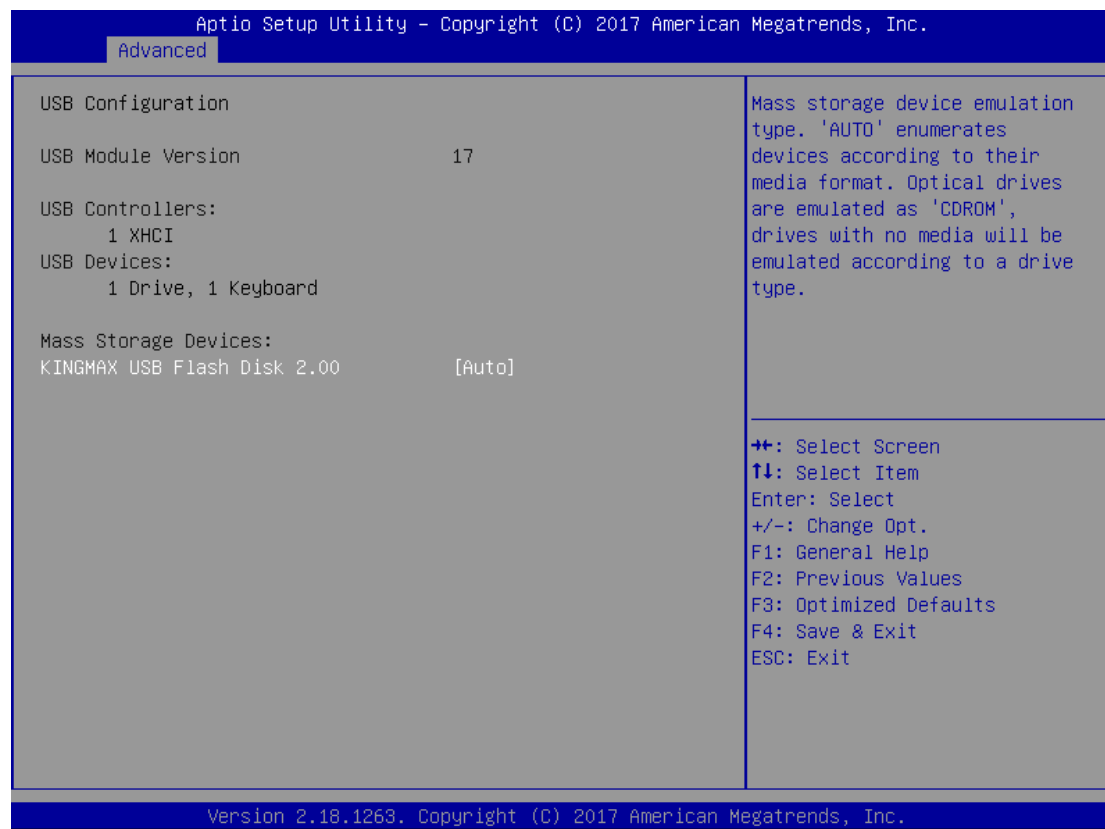

## Utility Configuration

User can use flash disk flash bios.

It must creat axiomtek folder in flash disk and it can recognize bios.



## 4.5 Chipset Menu

The Chipset menu allows users to change the advanced chipset settings.



## System Agent (SA) Configuration

### 1. Graphics Configuration

This option allows users to change the integrated graphic device settings.



**Primary IGFX Boot Display**

Select the video device which will be activated during POST.

**2. Memory Configuration**

This screen shows the memory information.

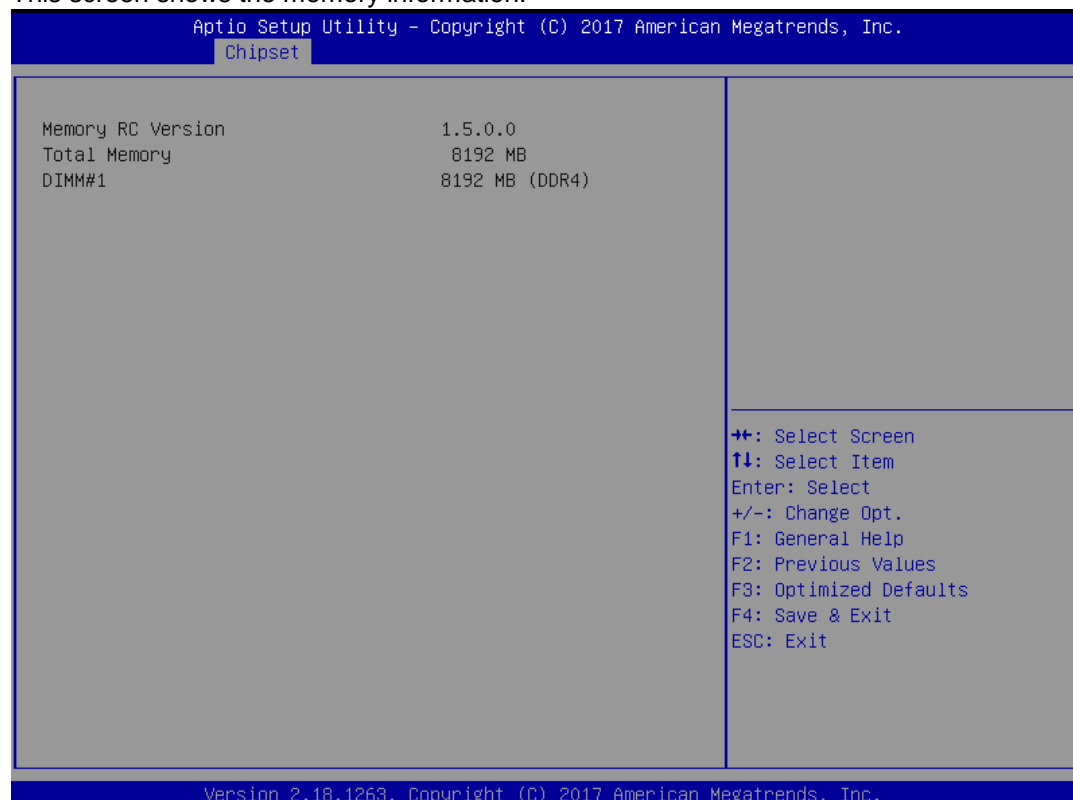

## 4.6 Security Menu

The security menu allows users to change the security settings for the system.

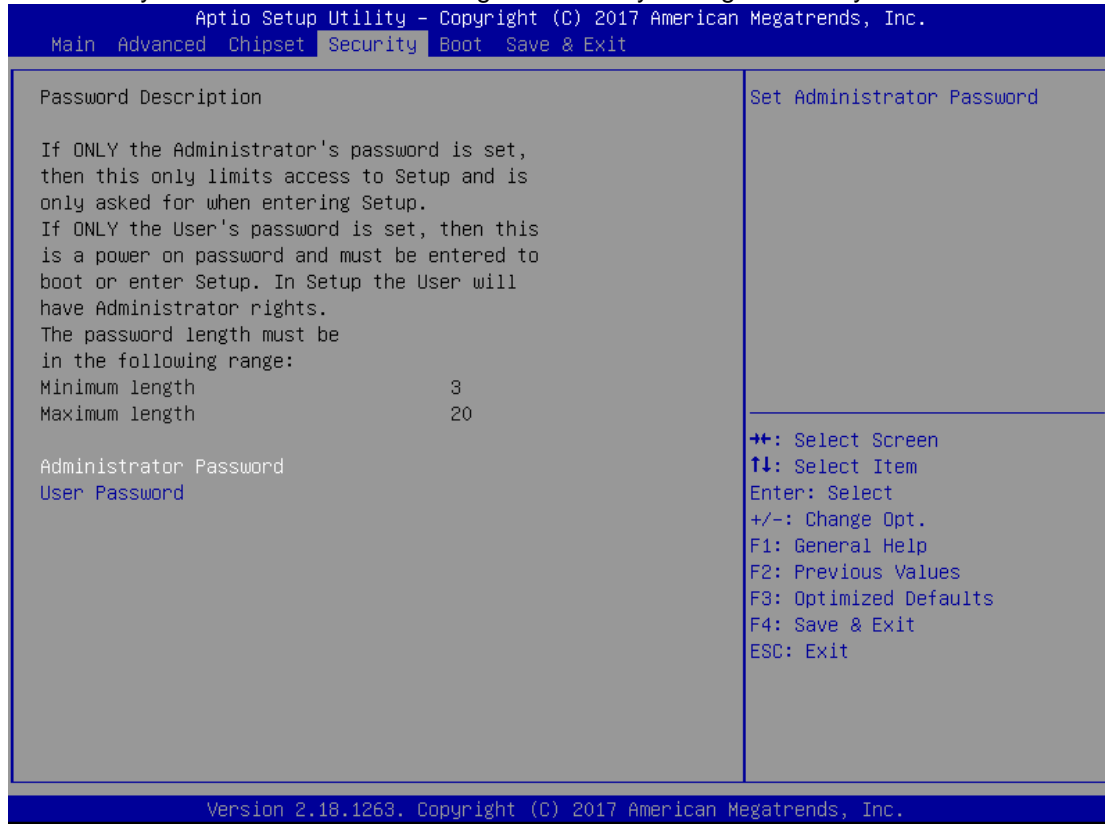

### Supervisor Password

This item indicates whether a supervisor password has been set. It will show "Installed" while the password has been set, or show "Not Installed" .

### User Password

This item indicates whether a user password has been set. It will show "Installed" while the password has been set, or show "Not Installed".

### Change Supervisor Password

Select this option and press <Enter> to access the sub menu. You can use the sub menu to change the supervisor password.

### Change User Password

Select this option and press <Enter> to access the sub menu. You can use the sub menu to change the user password.

## 4.7 Boot Menu

The Boot menu allows users to change boot options of the system. You can select any of the items in the left frame of the screen to go to the sub menus:

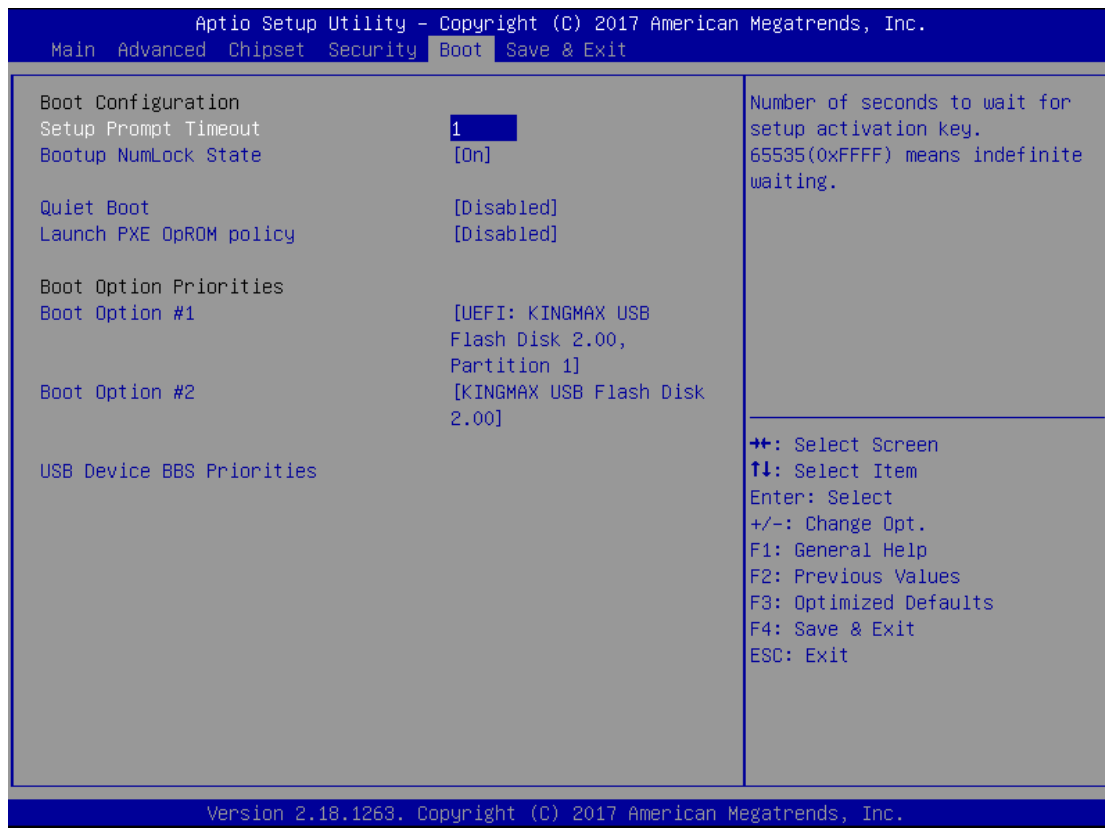

### Setup Prompt Timeout

Set the timeout for idle time of booting post while system power on.

### Bootup NumLock State

This option provides NumLock activation while system power on, the default setting is on.

### Launch PXE OpROM policy

Controls the execution of UEFI and Legacy PXE OpROM

### Boot Option Priorities

This option provides you to specify the overall boot order from the available devices.

## 4.8 Save & Exit Menu

This option allows users to operate optimized settings, customized settings and restore default settings for system configuration.

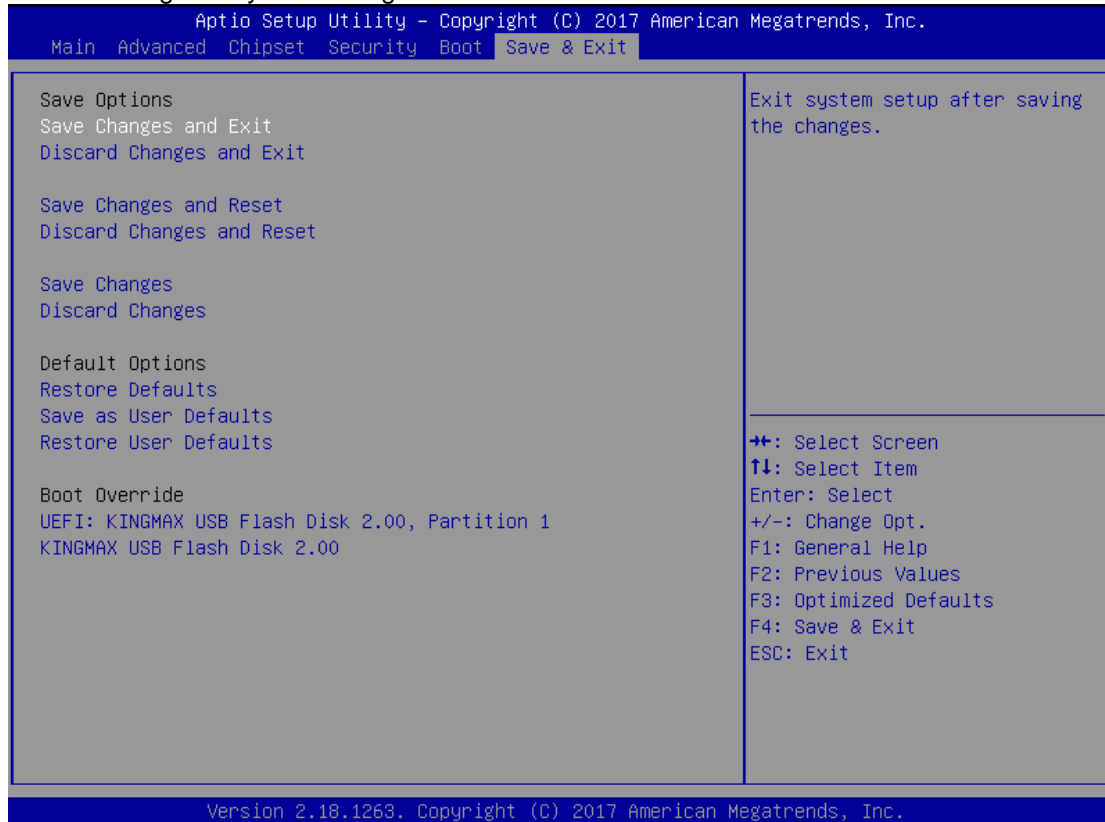

### Save Changes and Exit

When you have completed the system configuration changes, select this option to leave Setup and reboot the computer so the new system configuration parameters can take effect. Select *Save Changes and Exit* from the Exit menu and press <Enter>. Select Ok to save changes and exit.

### Discard Changes and Exit

Select this option to quit Setup without making any permanent changes to the system configuration. Select *Discard Changes and Exit* from the Exit menu and press <Enter>. Select Ok to discard changes and exit.

### Discard Changes

This option assist you to adndon all the values changes you set.

### Load Optimal Defaults

It automatically sets all Setup options to a complete set of default settings when you select this option. The Optimal settings are designed for maximum system performance, but may not work best for all computer applications. In particular, do not use the Optimal Setup options if your computer is experiencing system configuration problems. Select Load Optimal Defaults from the Exit menu and press <Enter>.

### Load Fail-Safe Defaults

It automatically sets all Setup options to a complete set of default settings when you select this option. The Fail-Safe settings are designed for maximum system stability, but not maximum performance. Select the Fail-Safe Setup options if your computer is experiencing system configuration problems.

Select Load Fail-Safe Defaults from the Exit menu and press <Enter>. Select Ok to load Fail-Safe defaults.



## APPENDIX A WATCHDOG TIMER

### What is Watchdog Timer

The integrated Watchdog Timer can be set up by programming. There are 1~255 levels available. As long as the value of timer is set, after enabling, the countdown of the value is starting. It needs to reset or disable watchdog, otherwise auto-reset will be running when the value is counted to 0.

### How to Use the Watchdog Timer

(Following is example to enable configuration by using debug tool)

#### Enable WDT

1. Enable configuration

-O 2E 87

-O 2E 87

2. Select Logic device:

-O 2E 07

-O 2F 08

3. WDT Device Enable

-O 2E 30

-O 2F 01

5. Set timer unit

-O 2E F0

-O 2F 00 → (00: Sec; 08: Minute)

4. Set base timer:

-O 2E F1

-O 2F 0A → Set Reset Time (Ex.0A:10 Sec)

Disable WDT

1. Enable configuration

-O 2E 87

-O 2E 87

2. Select Logic device:

-O 2E 07

-O 2F 08

3. WDT Device Disable

-O 2E 30

-O 2F 00

### Sample of Watchdog application

Assume there is program A which needs to maintain running in a system. The value of Watchdog Timer must be set bigger than the running time of program A. Then, after the running time of program A is finished, either to disable or to reset watchdog timer.

When program A has problems to make system shut down, the system can be rebooted by Watchdog timer when the value of watchdog timer is countdowned to 0.

The below flowchart can be referred to edit program A

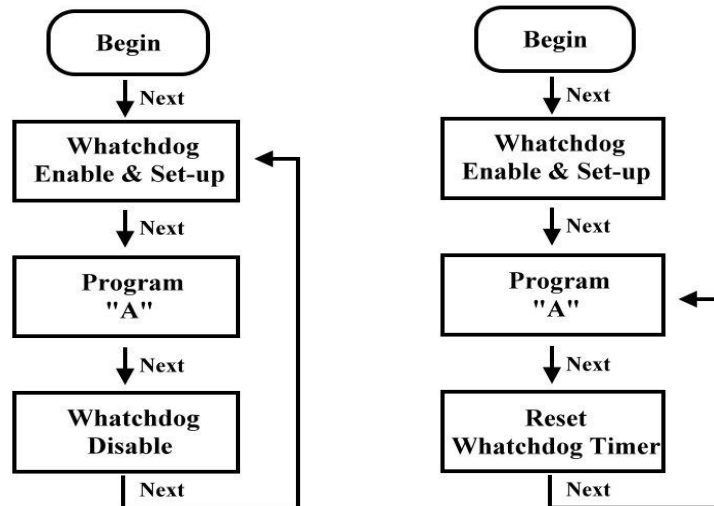

## APPENDIX B DIGITAL I/O

### Digital I/O Specification

#### Digital Input:

Input channels: 4, sink/source type

Input voltage: 0 to 30VDC at 25Hz

Input level for dry contacts:

Logic level 0: close to ground

Logic level 1: open

Input level for wet contacts:

Logic level 1: +/-3VDC max.

Logic level 0: +/- 10VDC min. to +/-30VDC max. (source to digital input)

#### Digital output:

output channels: 4, sink type

output current: 200mA max. per channel

on-state voltage: 12~ 24VDC nominal

max. voltage on COM+: 30VDC

### Digital I/O Software Programming

- I2C to GPIO PCA9554PW GPIO Group0[3:0] is Output, Group0[7:4] is Input.
- I2C address: 0b0100010x.
- Registers:

Register 0: Input Group0 register.

Table 4. Register 0 - Input Port register bit description

| Bit | Symbol | Access    | Value | Description                                  |
|-----|--------|-----------|-------|--|
| 7   | I7     | read only | X     | determined by externally applied logic level |
| 6   | I6     | read only | X     |  |
| 5   | I5     | read only | X     |  |
| 4   | I4     | read only | X     |  |
| 3   | I3     | read only | X     |  |
| 2   | I2     | read only | X     |  |
| 1   | I1     | read only | X     |  |
| 0   | I0     | read only | X     |  |

Register 2: Output Group0 register.

Table 5. Register 1 - Output Port register bit description

Legend: \* default value.

| Bit | Symbol | Access | Value | Description   |
|-----|--------|--------|-------|---|
| 7   | O7     | R      | 1*    | reflects outgoing logic levels of pins defined as outputs by Register 3 |
| 6   | O6     | R      | 1*    |   |
| 5   | O5     | R      | 1*    |   |
| 4   | O4     | R      | 1*    |   |
| 3   | O3     | R      | 1*    |   |
| 2   | O2     | R      | 1*    |   |
| 1   | O1     | R      | 1*    |   |
| 0   | O0     | R      | 1*    |   |

## Digital Input Wiring

### DRY contact

Logic level 0: close to ground  
 Logic level 1: open

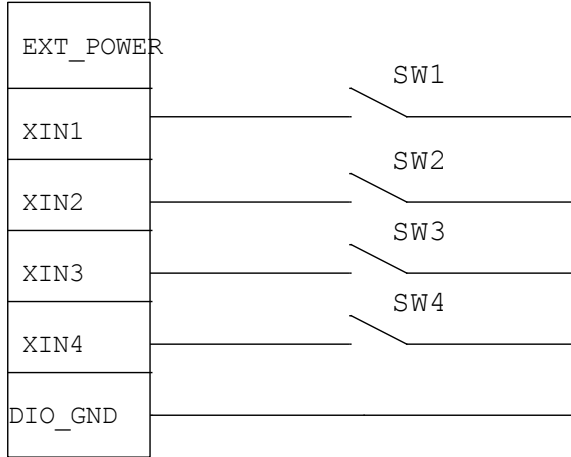

### WET contact

Logic level 1: +/-3VDC max.  
 Logic level 0: +/- 10VDC min. to +/-30VDC max

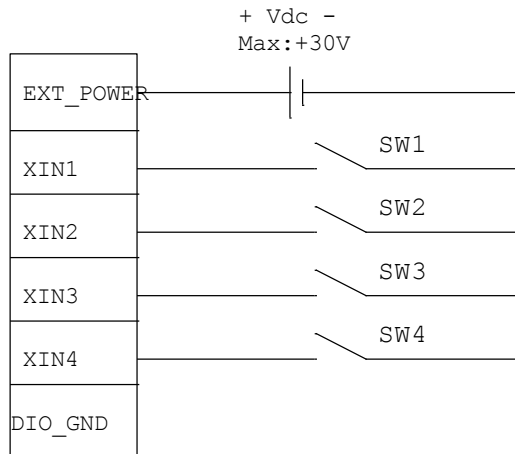

## Digital Output Wiring

